



US00D946373S

(12) **United States Design Patent**  
**Mizelle**

(10) **Patent No.:** **US D946,373 S**  
(45) **Date of Patent:** **\*\* Mar. 22, 2022**

- (54) **CONSTRUCTION TOOL**
- (71) Applicant: **R. Derek Mizelle**, Ayden, NC (US)
- (72) Inventor: **R. Derek Mizelle**, Ayden, NC (US)
- (73) Assignee: **R. Derek Mizelle**, Ayden, NC (US)
- (\*\*) Term: **15 Years**
- (21) Appl. No.: **29/737,407**
- (22) Filed: **Jun. 9, 2020**

D569,211	S *	5/2008	Peddie	.....	D8/88
D666,469	S *	9/2012	Melanson	.....	D8/89
8,763,225	B2 *	7/2014	Bruce	.....	B25B 27/02 29/275
D718,583	S *	12/2014	Macey	.....	D8/11
D723,888	S *	3/2015	Pope	.....	D8/7
D764,244	S *	8/2016	Brock	.....	B25J 1/04 D8/14
D772,036	S *	11/2016	Frassetto	.....	D8/88
D775,501	S *	1/2017	Marron	.....	D8/8
D780,542	S	3/2017	Rojas	.....	
9,681,597	B1 *	6/2017	Henshaw	.....	A01B 1/16
9,821,175	B2 *	11/2017	Dapkins, Jr.	.....	B25F 1/00
D810,527	S *	2/2018	Baker	.....	D8/10
D893,962	S *	8/2020	Murphy	.....	D8/7
2002/0134971	A1 *	9/2002	Christensen	.....	B66F 15/00 254/25
2005/0212314	A1 *	9/2005	Roderick	.....	B25B 27/00 294/211

**Related U.S. Application Data**

- (62) Division of application No. 29/665,315, filed on Oct. 2, 2018, now Pat. No. Des. 886,562.
- (51) **LOC (13) Cl.** ..... **08-05**
- (52) **U.S. Cl.**  
USPC ..... **D8/88**
- (58) **Field of Classification Search**  
USPC ..... D8/14, 88, 89, 6, 7, 8, 9, 10, 11, 105  
CPC . B66F 15/00; B25C 11/00; A01B 1/00; A01B  
1/16; A01B 1/02; A01B 1/022; A01B  
1/026  
See application file for complete search history.

(Continued)

*Primary Examiner* — Philip S Hyder  
(74) *Attorney, Agent, or Firm* — Stanek Lemon Crouse & Meeks PA

(57) **CLAIM**  
The ornamental design for a construction tool, as shown and described.

**DESCRIPTION**

FIG. 1 is a front perspective view of a construction tool, showing the new design;  
FIG. 2 is a front elevation view thereof;  
FIG. 3 is a rear elevation view thereof;  
FIG. 4 is a right side elevation view thereof;  
FIG. 5 is a left side elevation view thereof;  
FIG. 6 is a top plan view thereof; and,  
FIG. 7 is a bottom plan view thereof.  
The broken lines shown in the drawing views are included for the purpose of illustrating portions of the construction tool that form no part of the claimed design.

**1 Claim, 4 Drawing Sheets**

- (56) **References Cited**  
U.S. PATENT DOCUMENTS
- 1,687,986 A \* 10/1928 Miller ..... A01B 1/08  
172/381
- 4,135,751 A \* 1/1979 Gederos ..... A01K 80/00  
294/49
- 5,529,130 A \* 6/1996 Suk ..... A01B 1/16  
172/380
- 5,533,578 A \* 7/1996 Powell ..... A01B 1/04  
172/378
- 6,213,527 B1 \* 4/2001 Lampe ..... A01B 1/16  
172/375
- D532,273 S \* 11/2006 Yoson ..... D8/88

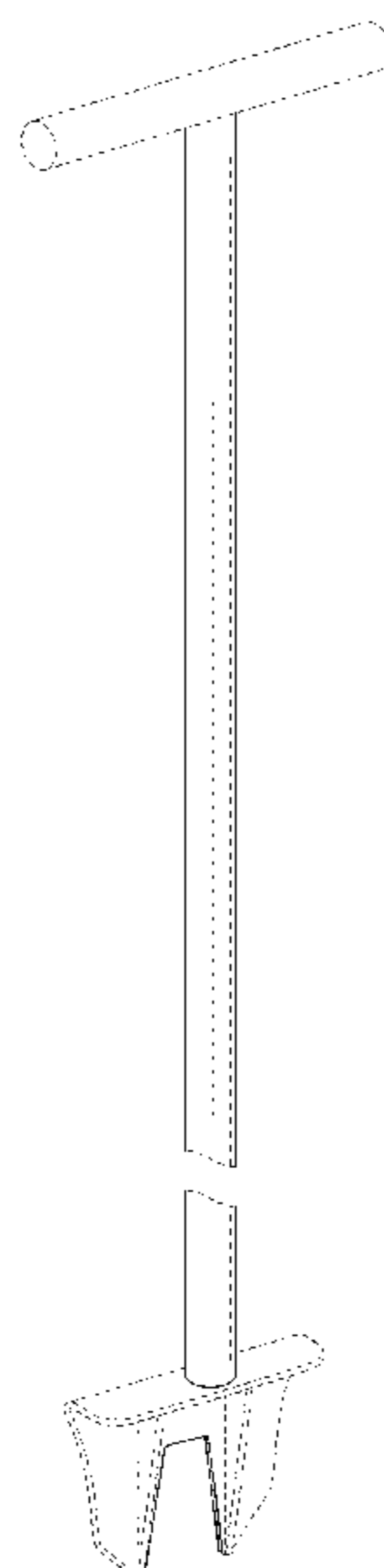

(56)

**References Cited**

U.S. PATENT DOCUMENTS

2010/0186344 A1\* 7/2010 Jones ..... E04F 21/22  
52/749.1  
2018/0343782 A1\* 12/2018 Pool ..... A01B 1/16

\* cited by examiner

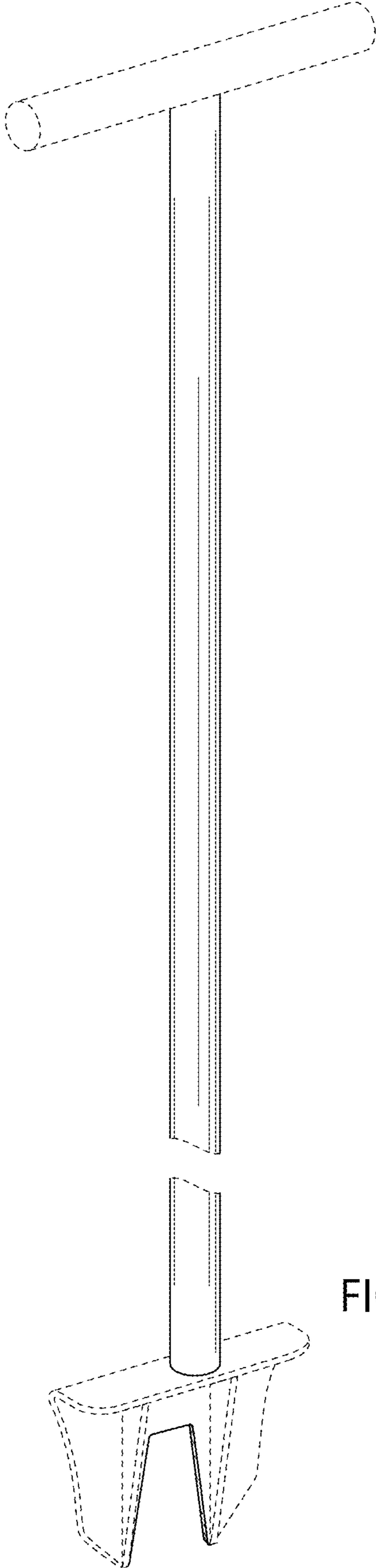
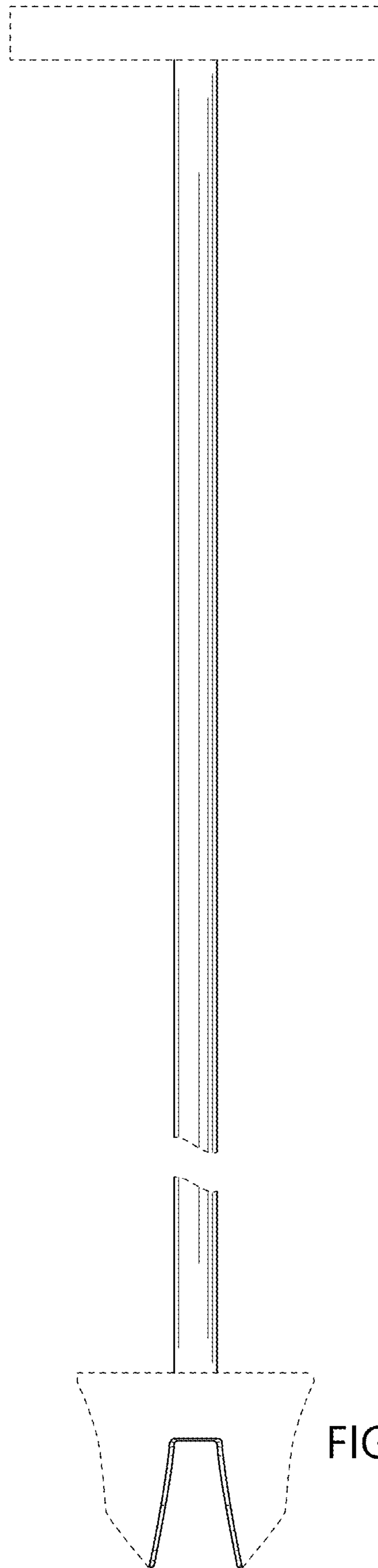
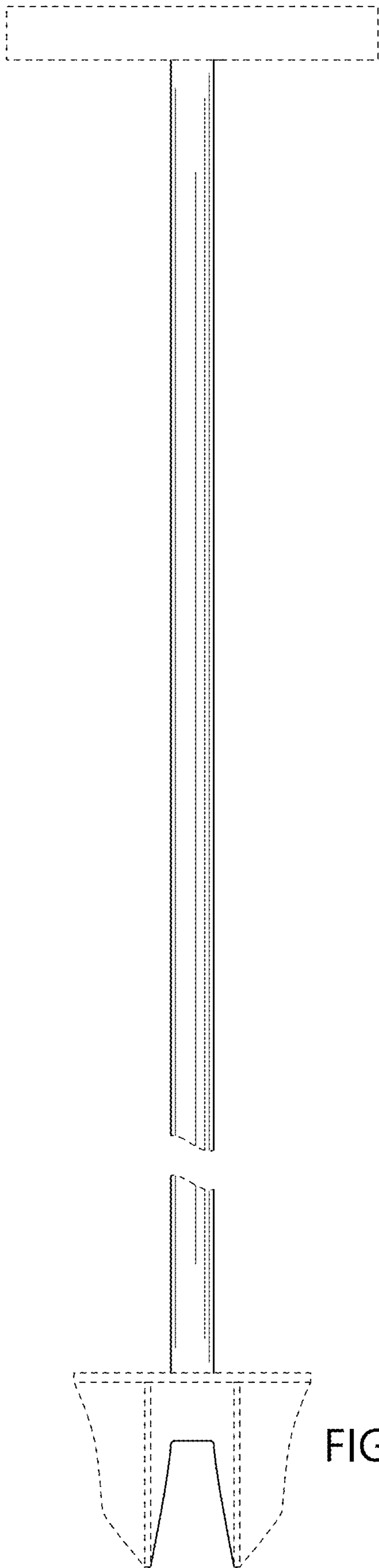

FIG. 1



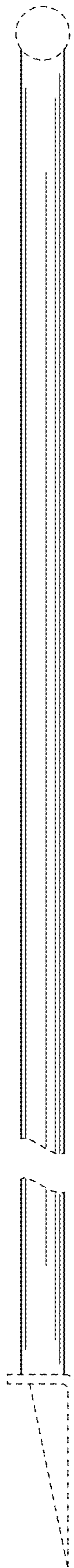

FIG. 4

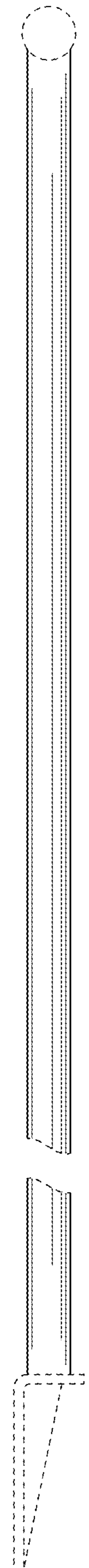

FIG. 5



FIG. 6

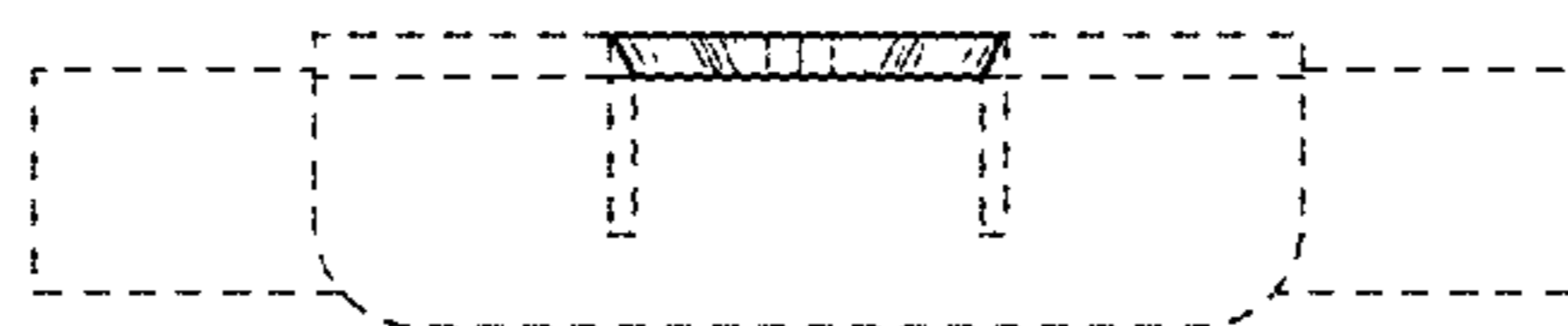

FIG. 7