

US00D946355S

(12) **United States Design Patent** (10) **Patent No.:** **US D946,355 S**
Zeitzer et al. (45) **Date of Patent:** **** Mar. 22, 2022**

(54) **BOTTLE HOLDER**

FOREIGN PATENT DOCUMENTS

(71) Applicant: **Victoria's Secret Stores Brand Management, LLC**, Reynoldsburg, OH (US)

CA 144552 S 9/2012
CA 144553 S 9/2012
CN 205931651 U 2/2017

(72) Inventors: **Cory Zeitzer**, Yardley, PA (US); **Alex Adamowsky**, Robbinsville, NJ (US)

OTHER PUBLICATIONS

(73) Assignee: **Victoria's Secret Stores Brand Management, LLC**, Reynoldsburg, OH (US)

Zeitzer et al., "Bottle Holder," Design U.S. Appl. No. 29/736,670, filed Jun. 2, 2020.

(**) Term: **15 Years**

Primary Examiner — Joseph Kukella
Assistant Examiner — Darryl J Dardenne
(74) *Attorney, Agent, or Firm* — Andrus Intellectual Property Law, LLP

(21) Appl. No.: **29/736,669**

(22) Filed: **Jun. 2, 2020**

(57) **CLAIM**

(51) **LOC (13) Cl.** **09-03**

The ornamental design for a bottle holder, as shown and described.

(52) **U.S. Cl.**

USPC **D7/624.2**

(58) **Field of Classification Search**

USPC D3/215, 226, 229; D7/300, 316, 318, D7/503, 507, 509, 510, 511, 602, 605, D7/608, 619.1, 619.2, 624.2, 624.3, 625, D7/701, 710; D6/417; D8/388, 391, D8/392; D9/455

CPC .. A47J 41/00; A47J 43/00; A47J 47/00; A47J 47/02; A47J 47/08; A47G 19/2205; A47G 19/2272; A47G 19/2288; A47G 19/23; A47G 21/145; A47G 23/0241; A47G 23/0266; A47G 23/16; A45F 3/16; A45F 2200/0583; A45F 2003/002; A45F 2005/006; A45F 3/02; A45F 5/00; B65D 1/265; B65D 3/22; B65D 23/08; B65D 23/0885; B65D 81/3453; B65D 81/3865;

(Continued)

DESCRIPTION

FIG. 1 is a perspective view of a first embodiment of a bottle holder according to our new and ornamental design; FIG. 2 is a front elevation view thereof; FIG. 3 is a rear elevation view thereof; FIG. 4 is a left side elevation view thereof; FIG. 5 is a right side elevation view thereof; FIG. 6 is a top plan view thereof; FIG. 7 is a bottom plan view thereof; FIG. 8 is a front view of a second embodiment of a bottle holder according to our new and ornamental design; and, FIG. 9 is a rear view of the second embodiment of the bottle holder shown in FIG. 8.

The dash-dot broken lines show the boundaries of the claimed design and form no part of the claim. The evenly dashed lines show portions of the bottle holder that form no part of the claim. The top plan view and bottom plan view of the second embodiment of the bottle holder are identical to the views shown in FIGS. 6 and 7, respectively.

(56) **References Cited**

U.S. PATENT DOCUMENTS

D304,890 S * 12/1989 Canaan D3/229
D331,629 S * 12/1992 Stewart D24/199

(Continued)

1 Claim, 8 Drawing Sheets

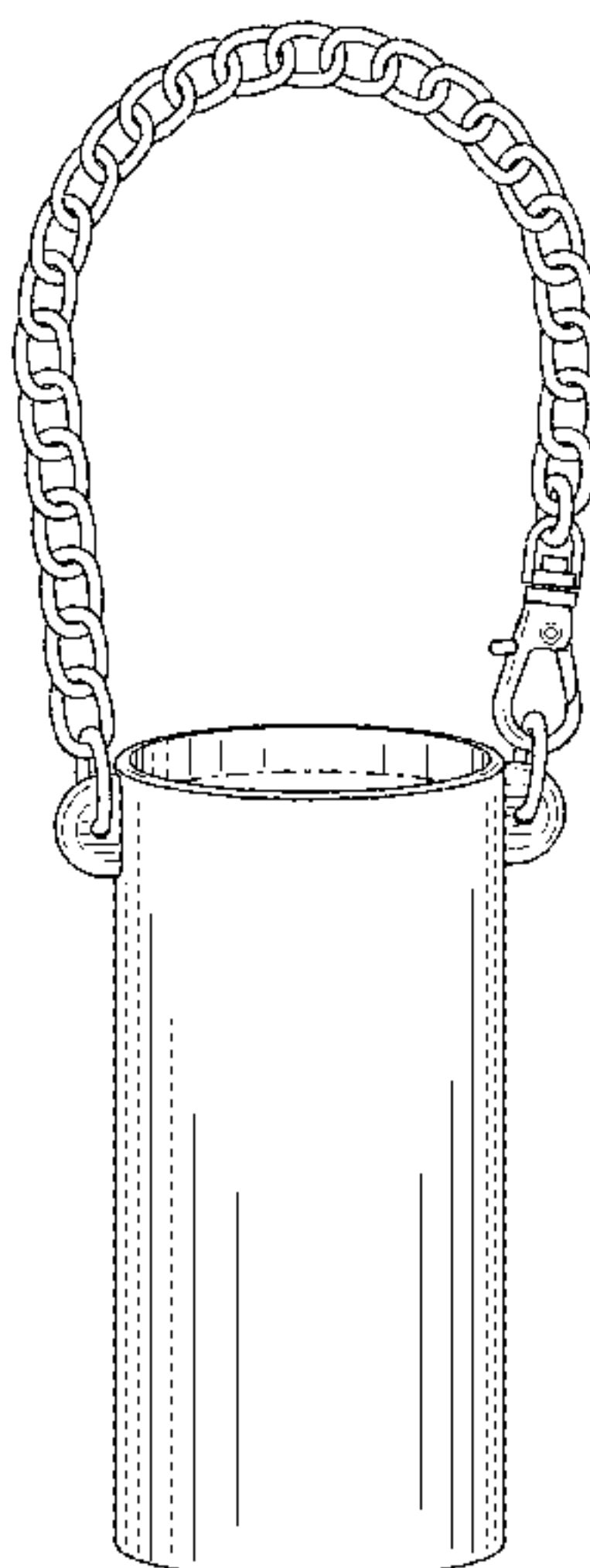

(58) **Field of Classification Search**

CPC B65D 81/3881; B65D 81/3883; B65D
81/3886; B65D 81/3879; F25D 3/08;
F25D 3/12; F25D 3/14

See application file for complete search history.

(56) **References Cited**

U.S. PATENT DOCUMENTS

D340,583 S * 10/1993 Kahn D3/202
D343,293 S * 1/1994 Montgomery D3/229
D347,766 S * 6/1994 Kalat D3/229
D350,024 S * 8/1994 Ryker D3/202
D378,022 S * 2/1997 Chen D3/229
D379,711 S * 6/1997 Fitzgerald D3/202
D387,248 S * 12/1997 Warren D7/507
D406,494 S * 3/1999 Corbella D7/608
D487,660 S * 3/2004 Sayers D6/513
D625,513 S * 10/2010 Carnes D3/229
D675,446 S * 2/2013 Cohee D3/318
D739,683 S * 9/2015 Krohn D7/619.1
D779,943 S * 2/2017 Tulencik D9/455
D779,945 S 2/2017 Tulencik
D780,442 S * 3/2017 Tidwell D3/229
D780,580 S * 3/2017 Tulencik D9/455
D831,487 S * 10/2018 Schlatter D9/455
D874,127 S * 2/2020 Wang D3/202
D885,148 S * 5/2020 Wang D7/701
D925,995 S * 7/2021 Wang D7/624.2
11,172,752 B2 * 11/2021 Dow A45F 3/02
2016/0360912 A1 * 12/2016 Chang A47G 23/0241

* cited by examiner

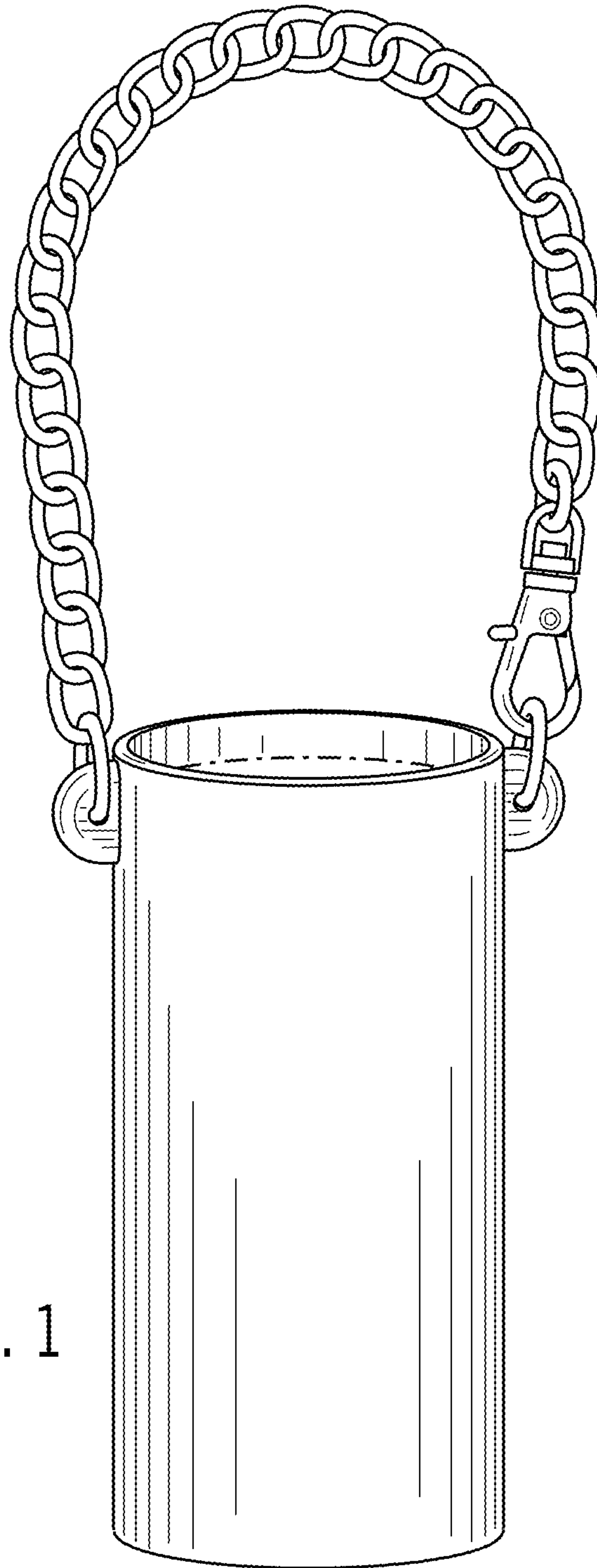

FIG. 1

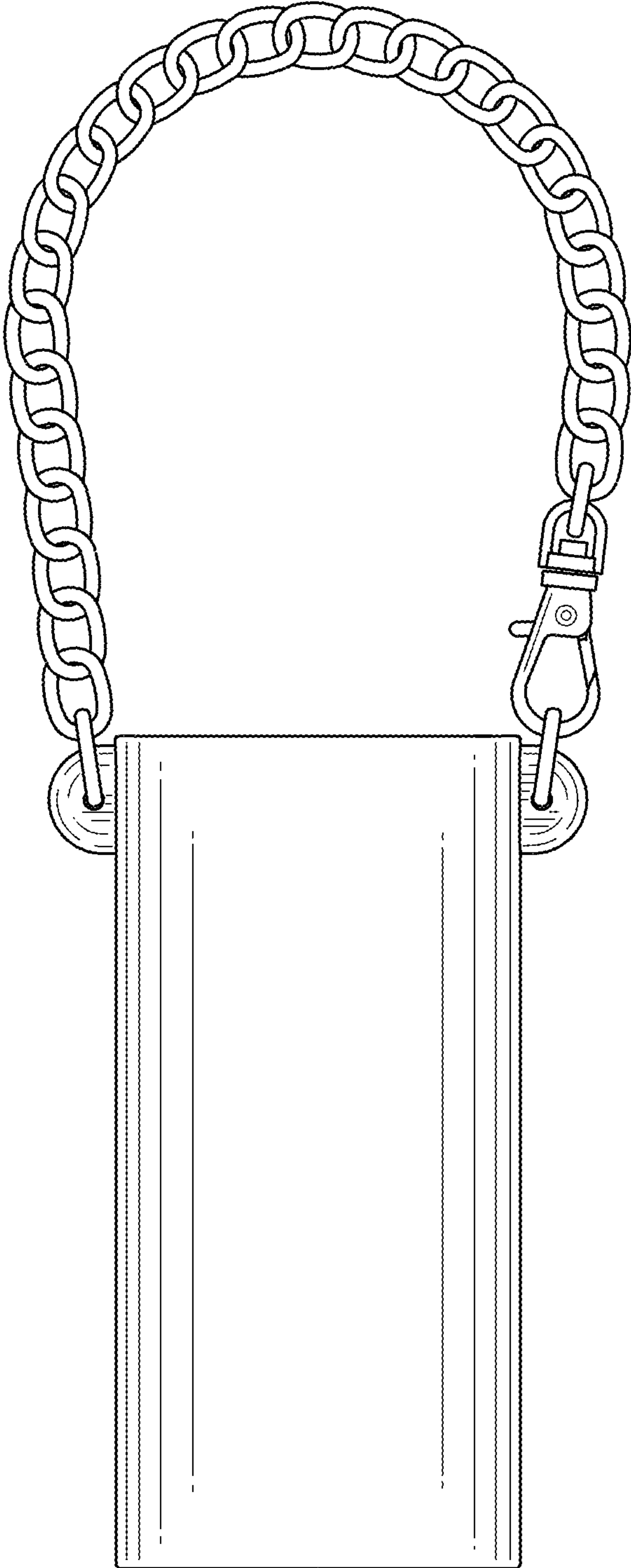

FIG. 2

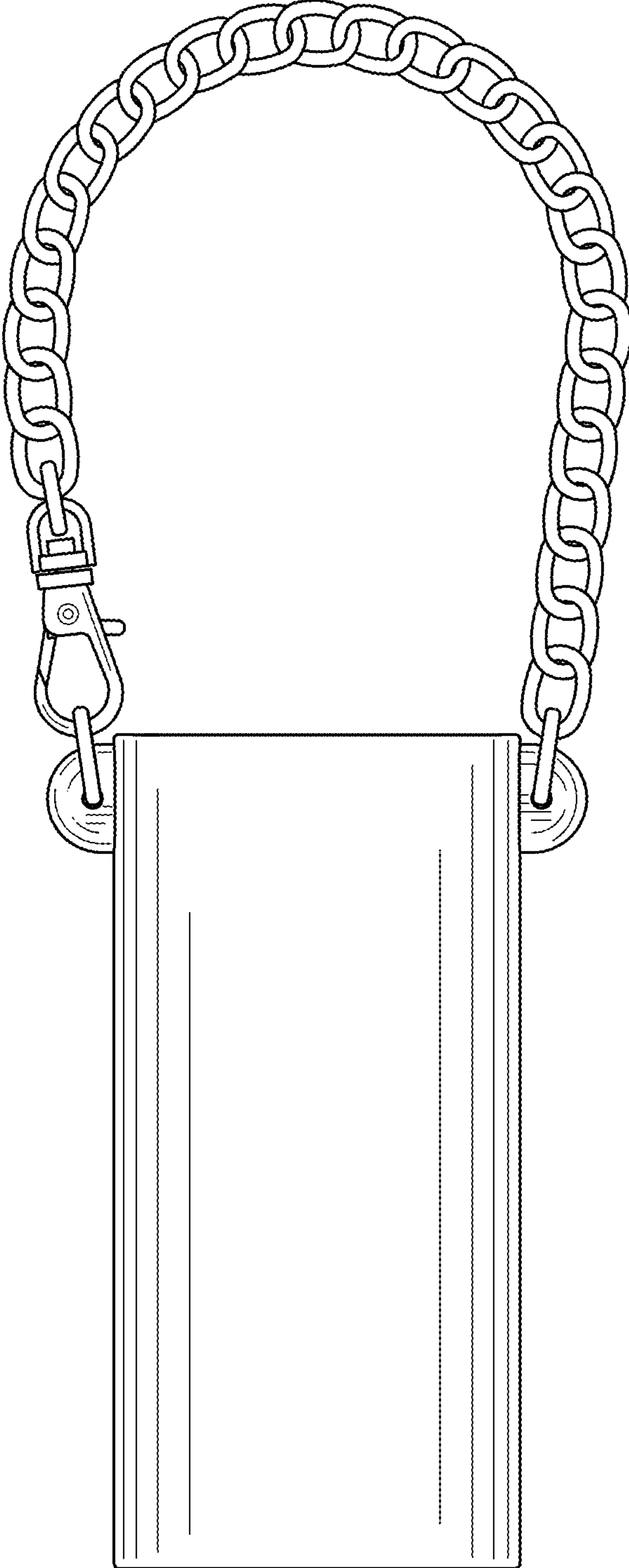

FIG. 3

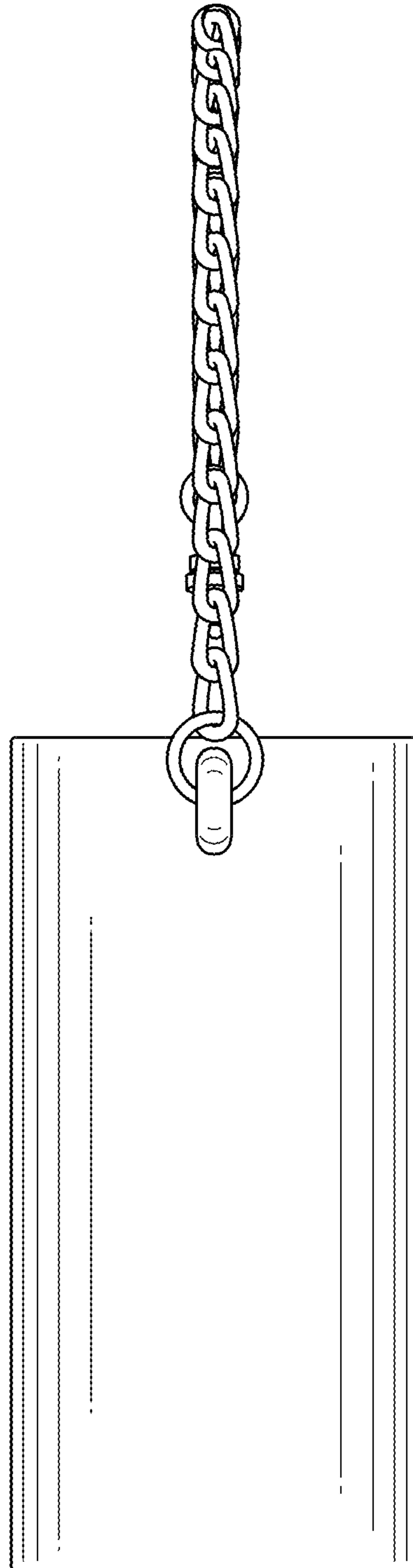

FIG. 4

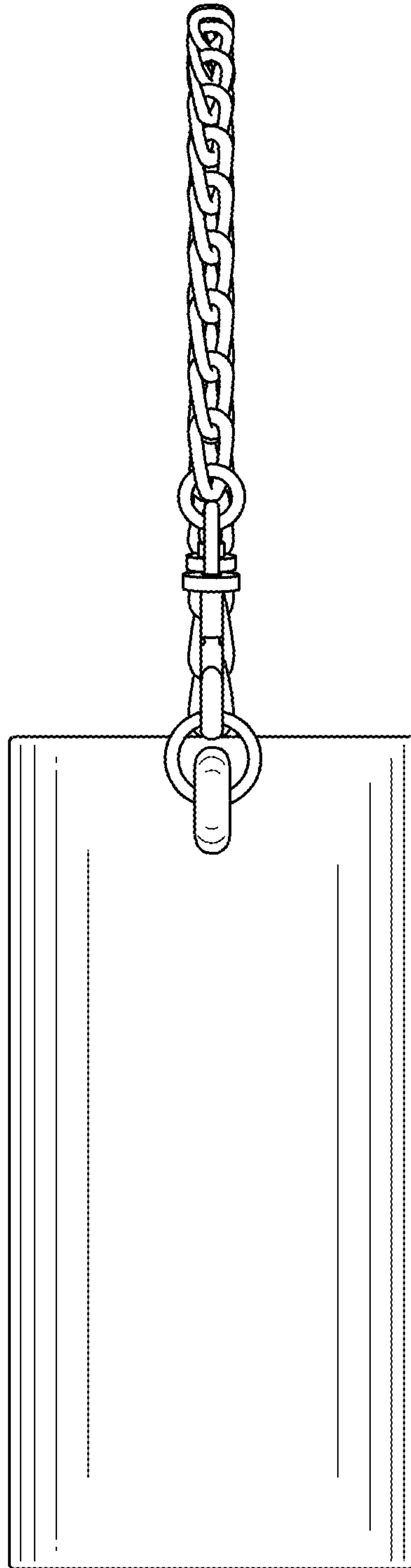

FIG. 5

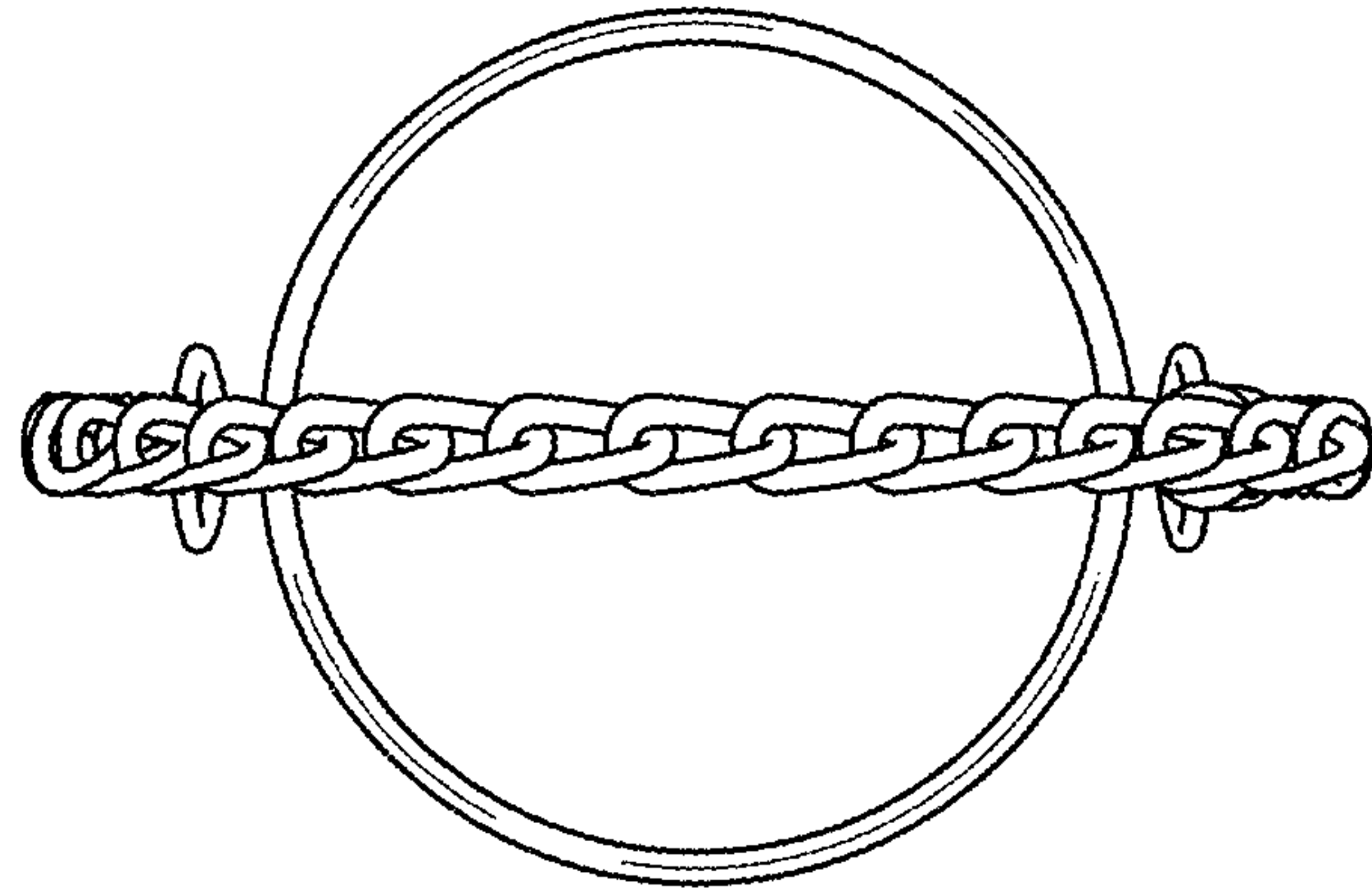

FIG. 6

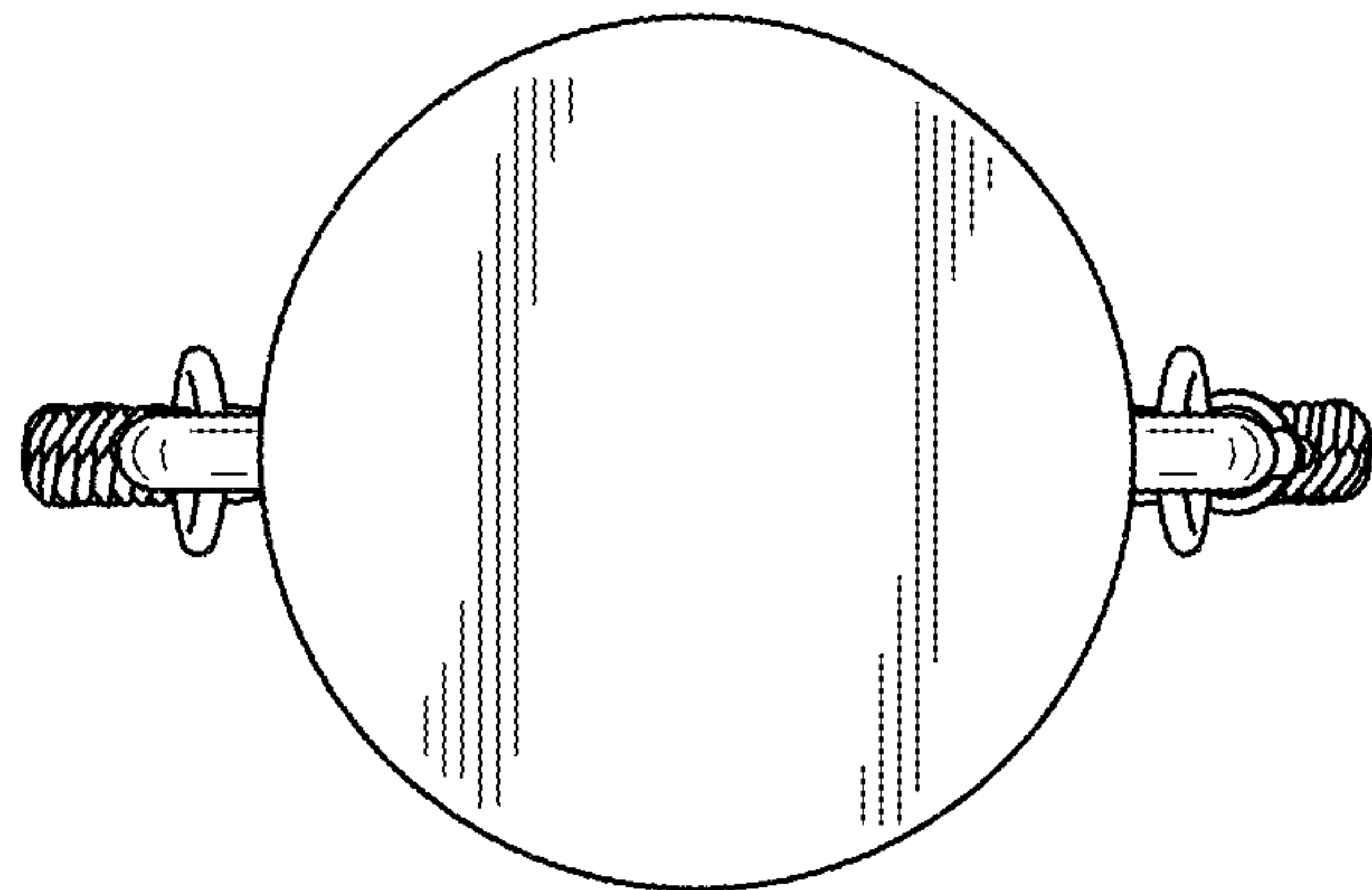

FIG. 7

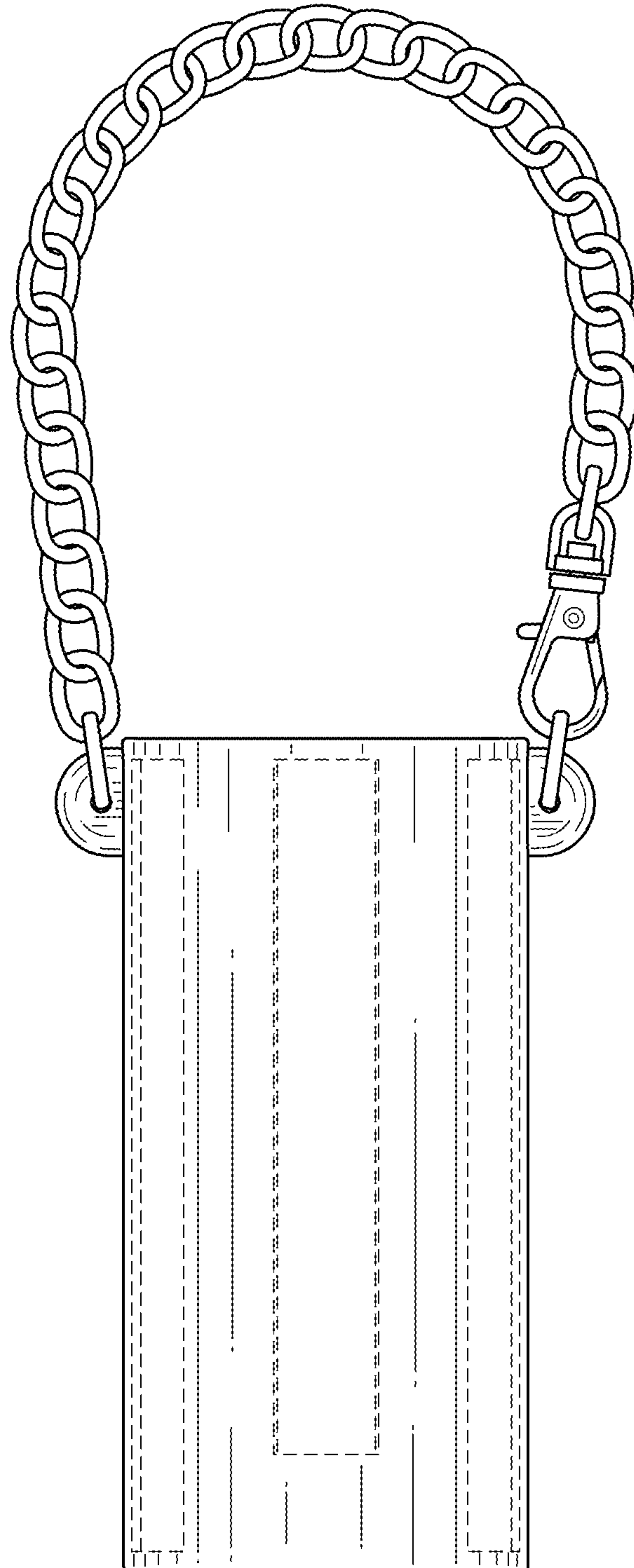

FIG. 8

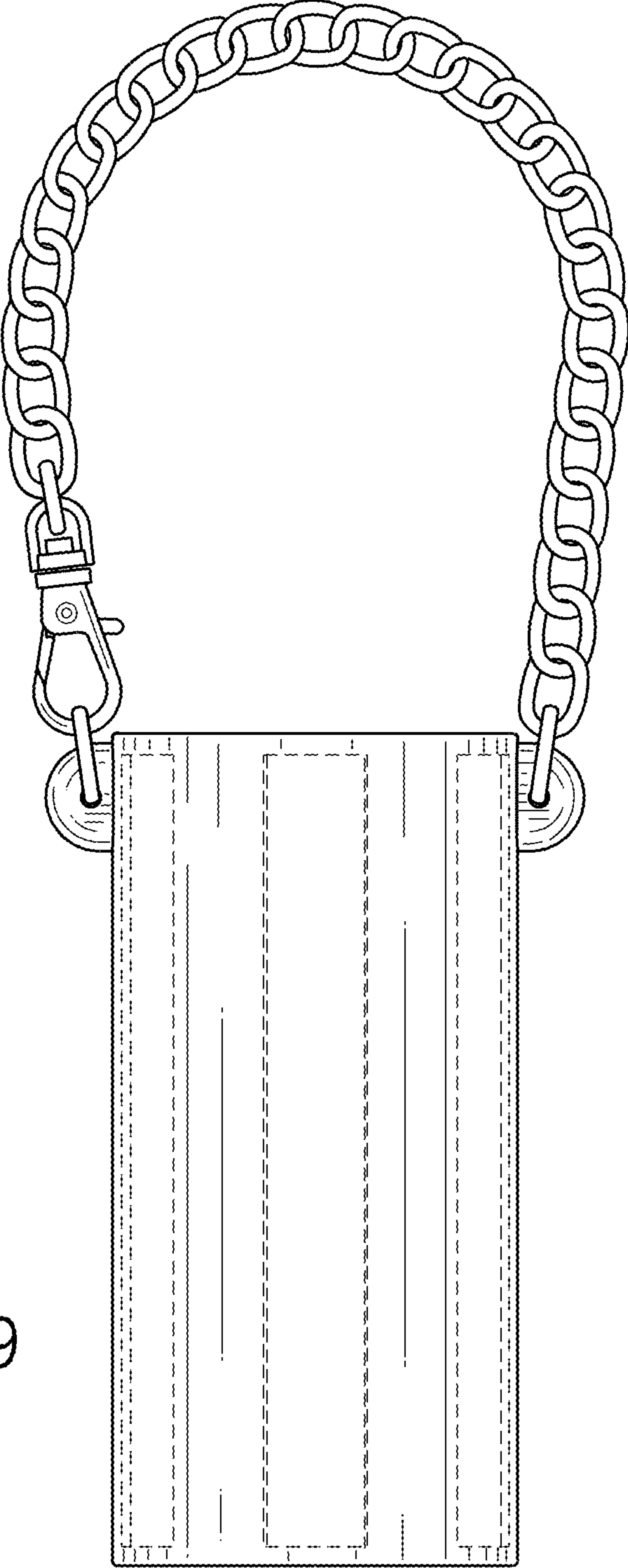

FIG. 9