



US00D946352S

(12) **United States Design Patent**
Pape et al.

(10) **Patent No.:** **US D946,352 S**

(45) **Date of Patent:** **** Mar. 22, 2022**

- (54) **CUP WITH LID**
- (71) Applicant: **MiiR Holdings, LLC**, Seattle, WA (US)
- (72) Inventors: **Bryan Pape**, Seattle, WA (US); **Joe Gray**, Seattle, WA (US)
- (**) Term: **15 Years**
- (21) Appl. No.: **29/740,319**
- (22) Filed: **Jul. 2, 2020**
- (51) **LOC (13) Cl.** **07-01**
- (52) **U.S. Cl.**
USPC **D7/511; D7/509**
- (58) **Field of Classification Search**
USPC D7/507, 509, 510, 511, 529, 531, 532, D7/523, 533, 534, 535, 536, 392.1, 396.1, D7/396.2, 300.1, 608; D3/202
CPC A47G 19/22; A47G 19/2288; A47G 19/2205; A47G 19/2211; A47G 19/2216; A47J 41/0077; A47J 41/0088; A47J 43/27; B65D 1/265
See application file for complete search history.

D278,121 S	3/1985	Sussman	
D279,346 S	6/1985	Ruxton	
D282,616 S	2/1986	Gallagher	
D289,143 S	4/1987	Guillaume	
D289,592 S	5/1987	Loughridge	
4,715,271 A	12/1987	Kitagawa	
4,863,601 A	9/1989	Wittekind et al.	
D306,970 S	4/1990	Bauer-Secundus	
D316,013 S	4/1991	Jones	
D323,758 S	2/1992	Hoelterscheidt	
5,132,124 A	7/1992	Tamaki	
5,226,585 A *	7/1993	Varano	B65D 81/3869 229/400
5,267,685 A *	12/1993	Sorensen	B65D 21/0233 206/503
5,318,786 A	6/1994	Clarkson	
D350,457 S	9/1994	Bailey	
D351,321 S	10/1994	Steppe, Sr.	
D353,973 S	1/1995	Adado	
D363,858 S	11/1995	Sweeney	
D365,721 S	1/1996	Huang	
5,509,583 A	4/1996	Dolson	
D377,293 S	1/1997	Husted	
5,605,710 A	2/1997	Pridonoff	
5,709,314 A	1/1998	Petry	
5,771,777 A	6/1998	Davis	
D395,794 S	7/1998	Moran	
D396,380 S	7/1998	Lai	
D398,852 S	9/1998	Gross	
5,842,408 A	12/1998	Hatta	
D409,051 S	5/1999	Huang	
D414,685 S	10/1999	Chahed	
D415,651 S	10/1999	Trombly	
D415,652 S	10/1999	Leow	
D417,127 S	11/1999	Steadward	
D417,817 S	12/1999	Loew	
D427,853 S	7/2000	Kohlhase	
D429,118 S	8/2000	Hurlbut	
D432,865 S	10/2000	Cohen	
D436,804 S	1/2001	Wolfe	
D438,298 S *	2/2001	McNutt	D23/366
D438,376 S	3/2001	Marshall	
RE37,773 E	7/2002	Trombley	
D465,132 S	11/2002	Janky	
D466,814 S	12/2002	Hurlburt	
D471,767 S	3/2003	Ucar Cortes	
D476,528 S	7/2003	Janky	
D478,287 S	8/2003	Corker	
D483,676 S	12/2003	Lee	
D488,029 S	4/2004	Bodum	
D488,673 S	4/2004	Farce	
D489,573 S *	5/2004	Li	D7/530
D490,274 S	5/2004	Irvine	

(56) **References Cited**
U.S. PATENT DOCUMENTS

2,414,901 A	1/1947	Schlumbohm	
2,705,086 A	3/1955	Schlumbohm	
2,889,065 A	6/1959	Lawlor	
D199,320 S	10/1964	Sweet	
3,194,468 A *	7/1965	Baron	B65D 81/3865 229/400
D202,643 S	10/1965	Hoyt, Jr.	
3,327,881 A	6/1967	Maier	
3,344,734 A	10/1967	Aguirre-Batres et al.	
3,465,905 A	9/1969	Schottanes	
3,536,496 A	10/1970	Paoloni	
3,603,106 A	9/1971	Ryan	
3,730,383 A	5/1973	Dunn	
3,739,932 A	6/1973	Westover	
3,800,954 A	4/1974	Lampcov	
D248,358 S *	7/1978	Thomas	D7/531
4,362,623 A	12/1982	Holopainen	
D274,115 S	6/1984	Gavin	

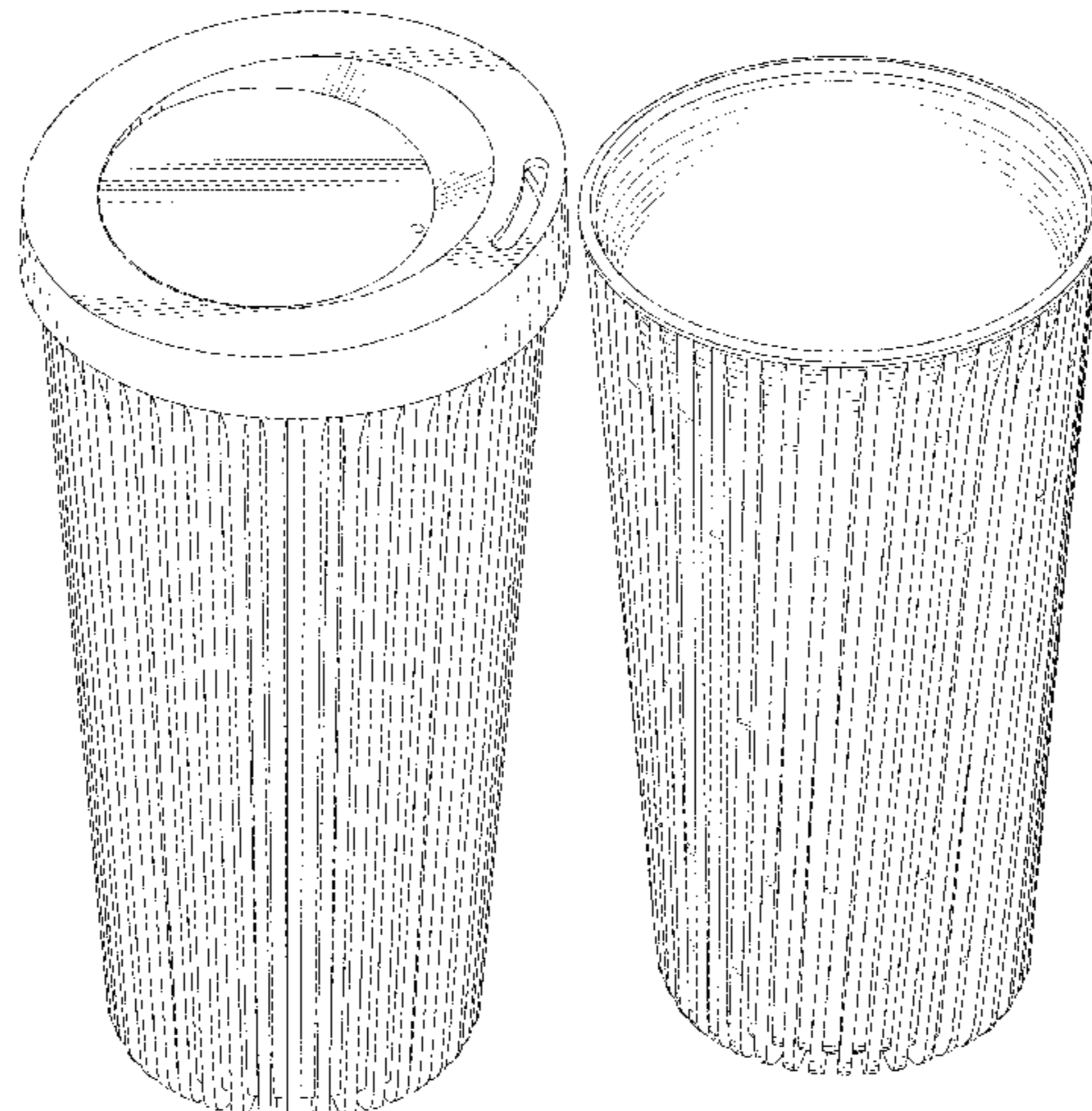

US D946,352 S

D495,186 S	8/2004	Poupel		D724,896 S	3/2015	Williams	
D504,796 S	5/2005	Schuler		D728,313 S	5/2015	Bo	
D519,320 S	4/2006	Festa		D731,240 S	6/2015	Bell	
D522,312 S	6/2006	Bodum		D731,241 S	6/2015	Yessin	
D522,796 S	6/2006	Teh-Hsiung		D734,206 S	* 7/2015	Thuma	D11/153
D523,693 S	6/2006	Bodum		D735,528 S	8/2015	Hubert	
D527,576 S	9/2006	Gluck		D740,029 S	10/2015	Otto	
D530,607 S	10/2006	Cornet		D740,073 S	10/2015	Zorovich	
D534,396 S	1/2007	Kramer		D740,612 S	* 10/2015	Crosby	D7/531
7,172,101 B2	2/2007	Find		D742,173 S	11/2015	Perman	
D539,608 S	4/2007	Lapsker		D743,269 S	11/2015	Pape	
D549,522 S	8/2007	Tien		D744,280 S	12/2015	Chiang	
D561,594 S	2/2008	Condon		D746,701 S	1/2016	Pape	
D562,072 S	2/2008	Wahl		D747,626 S	1/2016	Morris, II	
D564,883 S	3/2008	Rica		D750,437 S	3/2016	Katterheinrich	
D565,798 S	4/2008	Ivanova		D750,934 S	3/2016	Kemker	
D567,102 S	4/2008	Rhoden		D751,331 S	3/2016	Rashid	
H2217 H	6/2008	Smay		D752,397 S	3/2016	Seiders	
D572,975 S	7/2008	Germany		D756,712 S	5/2016	Kushner	
D573,017 S	7/2008	Henderson		D757,542 S	5/2016	Prum	
D609,571 S	2/2010	Butler		D758,793 S	6/2016	Ho	
D614,918 S	5/2010	Chisholm		D758,859 S	6/2016	Sorensen	
D614,955 S	5/2010	Cresswell		D760,586 S	7/2016	Seiders	
D614,961 S	5/2010	Thomas		D761,054 S	7/2016	Simontov	
D617,608 S	6/2010	Yang		D763,622 S	8/2016	Shirley	
D618,508 S	6/2010	George		D764,870 S	8/2016	Choi	
D621,220 S	8/2010	Lown		D765,008 S	8/2016	Conrad	
D621,648 S	8/2010	Lown		D767,238 S	9/2016	Boroski	
D621,659 S	* 8/2010	Liu	D7/510	D767,328 S	9/2016	Boroski	
D622,360 S	8/2010	Bouroullec et al.		D767,337 S	9/2016	Boroski	
D623,896 S	9/2010	Wahl		D768,435 S	10/2016	Hoorntje	
D623,949 S	9/2010	Thronsdn		D771,439 S	11/2016	Miller	
D624,356 S	9/2010	Davies		D772,651 S	11/2016	Leonard	
D625,541 S	10/2010	Kauer		D773,250 S	12/2016	Miller	
D627,602 S	11/2010	Eyal		D774,837 S	12/2016	Seiders	
D628,486 S	12/2010	Lane		D779,275 S	* 2/2017	Crosby	D7/531
D632,522 S	2/2011	Wahl		D779,276 S	* 2/2017	Crosby	D7/531
D635,401 S	4/2011	DelVecchio		D780,577 S	3/2017	Seiders	
7,918,364 B2	4/2011	Kim		D781,101 S	3/2017	Barber	
D639,177 S	6/2011	Pape		D781,145 S	3/2017	Seiders	
D639,608 S	6/2011	Tohm, Sr.		D781,146 S	3/2017	Seiders	
D644,062 S	8/2011	Lorenz		D783,368 S	4/2017	Seiders	
D650,633 S	12/2011	Birgers		D784,137 S	4/2017	Cates	
D652,255 S	1/2012	Carland		D786,619 S	5/2017	Joseph	
D653,079 S	1/2012	King		D787,270 S	5/2017	Mishan	
D654,869 S	2/2012	Konz		D789,134 S	6/2017	Lin	
D655,167 S	3/2012	Weber-Trinkfass		D789,737 S	6/2017	Eyal	
D656,361 S	3/2012	Gilbert		D794,460 S	8/2017	Notheis	
D658,878 S	5/2012	Deguglimo		D795,008 S	8/2017	Eyal	
D659,007 S	5/2012	Pape		D795,013 S	8/2017	Shultz	
D661,939 S	6/2012	Kern		D795,643 S	8/2017	Barlow	
D664,001 S	* 7/2012	Liu	D7/510	D799,320 S	10/2017	Goodwin	
D668,913 S	10/2012	Mayer		D802,362 S	11/2017	Spivey	
8,336,732 B1	* 12/2012	Tobias	B65D 1/265 220/839	D804,905 S	12/2017	Seiders	
D675,100 S	1/2013	Herbst		D805,852 S	12/2017	Seiders	
D678,068 S	3/2013	Huang		D808,802 S	1/2018	Seiders	
D679,188 S	4/2013	Zuchetta		D812,432 S	3/2018	Seiders	
D679,942 S	4/2013	Lyall, III		D812,979 S	3/2018	Seiders	
D679,979 S	4/2013	Meritt		D814,240 S	4/2018	Kabalin	
D680,435 S	4/2013	Wanet		D814,243 S	4/2018	Pape	
D684,312 S	6/2013	Badawi		D814,852 S	4/2018	Melanson	
D684,805 S	6/2013	Bjerre-Poulsen		D815,890 S	4/2018	Boroski	
D695,138 S	12/2013	Ball		D815,903 S	4/2018	Steel	
D700,802 S	3/2014	Miller		D816,162 S	* 4/2018	Fassi	D19/85
D701,079 S	3/2014	Arora		D816,165 S	4/2018	Fassi	
D702,506 S	4/2014	Mettler		D816,398 S	5/2018	Fleischhut	
8,690,006 B1	4/2014	Chiorazzi		D817,093 S	5/2018	Silsby	
D708,954 S	6/2014	Barnes		D819,396 S	6/2018	Seiders	
8,746,131 B2	6/2014	Saitoh		D819,405 S	* 6/2018	Li	D7/531
D709,328 S	7/2014	Ross		D820,044 S	6/2018	Jenkins	
D717,109 S	11/2014	Simontov		D820,085 S	6/2018	Moore	
D717,115 S	11/2014	Lane		D823,537 S	7/2018	Beaver	
D718,577 S	* 12/2014	Gonzales	D7/531	D826,641 S	8/2018	Nickley	
D721,251 S	1/2015	Stamper		D830,128 S	10/2018	Rohe	
D722,476 S	2/2015	Kilduff		D833,820 S	11/2018	Bram	
D722,830 S	2/2015	Miller		D834,881 S	12/2018	Seiders	
8,960,528 B2	* 2/2015	Sadlier	B65D 3/22 229/403	D835,459 S	12/2018	Sedgwick	
				D840,187 S	2/2019	Sams	
				D841,391 S	2/2019	Pape	

D842,027	S	3/2019	Boroski	
D842,038	S	3/2019	Seiders	
D843,212	S	3/2019	Seiders	
D844,383	S	4/2019	Seiders	
D846,995	S	4/2019	El Beaini	
D847,579	S	5/2019	Khan	
D848,791	S	5/2019	Khayman	
10,329,070	B2	6/2019	Wengerd	
D855,390	S	8/2019	Lullie	
D857,462	S	8/2019	Silsby	
D864,645	S	10/2019	Perez	
D867,058	S	11/2019	Spivey	
10,479,544	B2 *	11/2019	Crosby	B65D 81/3865
D868,536	S	12/2019	Henkel	
D871,844	S	1/2020	Adams, Jr.	
D873,603	S	1/2020	Diener	
D874,216	S	2/2020	Henkel	
D877,609	S	3/2020	Elman	
D878,932	S	3/2020	Holley, Jr.	
D882,111	S	4/2020	Bib	
D882,339	S *	4/2020	Pape	D7/510
D884,472	S	5/2020	Matauch	
D885,177	S	5/2020	Sevsek	
D887,774	S	6/2020	Matauch	
D890,573	S	7/2020	Jacobsen	
D891,966	S	8/2020	Ames	
D896,026	S	9/2020	Chu	
D909,143	S	2/2021	Pisarevsky	
D911,109	S *	2/2021	Johnson	D7/507
D913,046	S	3/2021	Spivey	
2003/0059500	A1	3/2003	Bailey et al.	
2003/0076673	A1	4/2003	Diak/Ghanem	
2006/0177159	A1	8/2006	Aikenhead	
2009/0283526	A1 *	11/2009	Pierce	A47G 19/22 220/254.7
2010/0288782	A1	11/2010	Lin	
2011/0198352	A1	8/2011	Lown	
2012/0000369	A1	1/2012	Saitoh et al.	
2012/0247998	A1	10/2012	Wahl	
2013/0334166	A1	12/2013	Garipalli	
2014/0061208	A1	3/2014	Boyd	
2014/0102965	A1	4/2014	Jones	
2015/0374151	A1	12/2015	Lin	
2016/0058227	A1	3/2016	Albers	
2016/0100702	A1	4/2016	Albers	
2016/0137332	A1 *	5/2016	Crosby	B65D 25/205 206/459.5
2017/0055743	A1	3/2017	Jorge	
2017/0071394	A1	3/2017	Numata	
2017/0101209	A1	4/2017	Viedt	
2017/0251850	A1	9/2017	Coon	
2017/0253392	A1 *	9/2017	Bann	B65D 51/18
2017/0273484	A1	9/2017	Spivey	
2018/0050925	A1	2/2018	Gregory	
2018/0134520	A1	5/2018	Mikkonen et al.	
2018/0194520	A1 *	7/2018	Lovern	A01N 25/34
2018/0257853	A1	9/2018	Chuang	
2019/0029460	A1	1/2019	Cohen	
2019/0313837	A1	10/2019	Wu	
2021/0282587	A1 *	9/2021	Maskell	A47G 19/2288

FOREIGN PATENT DOCUMENTS

CN	300990171	*	8/2009
CN	102802462		11/2012
KR	301042237.0000	*	1/2020

OTHER PUBLICATIONS

MCM Ribbed Tumbler_Etsy [online] URL: <https://www.etsy.com/listing/902531336/mcm-ribbed-tumblerdrinking-glass?> (site visited: Aug. 2021) (Year: 2000).*

Photo of a takeaway disposable paper co [online] URL: <https://www.alamy.com/stock-photo-photo-of-a-takeaway-disposable-paper-coffee-cup-on-a-background-of-48109339.html?> (site visited: Aug. 2021) (Year: 2012).*

Huskee Cup and Lid [online] URL: <https://www.amazon.com/Huskee-Cup-Lid-Natural-12oz/dp/B07XGKMK7/> (site visited: Aug. 2021) (Year: 2019).*

16oz Ripple-Wrap™ Hot Cup _ Cups & Cup Accessories [online] URL: <https://www.detpak.com/detpak/cups--cup-accessories/ripple-wrap-hot-cups/r292s0001/> (site visited: Aug. 2021) (Year: 2021).*

ONDE Vase Natural or Mist White Minimalist wooden vase _ Etsy [online] URL: <https://www.etsy.com/listing/1037014647/onde-vase-natural-or-mist-white?> (site visited: Aug. 2021) (Year: 2021).*

Pack of 8 Coffee Cups With Lids [online] URL: <https://www.therange.co.uk/cooking-and-dining/outdoor-dining/> (site visited: Aug. 2021) (Year: 2021).*

Patient Cups Plastic Ribbed 5oz Lavender 1000_case [online] URL: <https://www.dhpsupply.com/item/630-9210/Patient-Cups-Plastic-Ribbed/> (site visited: Aug. 2021) (Year: 2021).*

Pleated Vacuum Cleaner Air Filter Cartridge PTFE Material 0112311 Model [online] URL: <https://www.cartridgefilterelement.com/sale-11508762-pleatedvacuum-cleaner-air-filter-cartridge-ptfe-material-0112311-model.html> (site visited: Aug. 2021) (Year: 2021).*

Ripple Cups, Ripple Coffee Cups, Ripple Paper Cups in Stock—ULINE [online] URL: https://www.uline.com/BL_594/Uline-Ripple-Insulated-Cups (site visited: Aug. 2021) (Year: 2020).*

Kaffeeform—Reusable Weducer Cup [online] URL: <https://www.kaffeeform.com/en/shop/weducer-cup/> (site visited: Aug. 2021) (Year: 2020).*

“Tervis Lids”“, retrieved from <http://www.tervis.com/designs/Accessories/Travel-lids/dc0fe00377e0ec722da5bd146541427c#!upc093597437694&upc093597240386> on Sep. 10, 2015.”

https://www.amazon.com/dp/B081B8LV77/ref=cm_sw_em_r_mt_dp_3q4.FbPY3ZKQF?_encoding=UTF8&psc=1 (year: 2019).

https://www.amazon.com/MAGEDON-Carrier-handheld-Running-jogging/dp/B07FMTQ5Y2/ref=sr_1_25?dchild=1&keywords=thermos+bottle+with+handle&qid=1621704019&sr=8-25 (year:2019).

https://www.amazon.com/Simple-Modem-Classic-Tumbler-Straw/dp/B07D4BNCCM/ref=sr_1_16?dchild=1&keywords=lid+with+removable+straw&qid=1630612378&sr=8-16 Simple Modem (Year: 2018).

Tronco 20oz Glass Tumbler Straw Silicone Protective Sleeve Bamboo Lid—BPA free https://www.amazon.com/dp/B07H3SNFQN/ref=cm_sw_em_r_mt_dp_M87K7J1FQGEJ597A46AC?encoding=UTF8&psc=1 (year:2017).

MCM Ribbed Tumbler _ Etsy [online] URL: <https://www.etsy.com/listing/902531336/mcm-ribbed-tumblerdrinking-glass?> (site visited: Feb. 2021) (Year: 2000).

Photo of a takeaway disposable paper co [online] URL: <https://www.alamy.com/stock-photo-photo-of-a-takeaway-disposable-paper-coffee-cup-on-a-background-of-48109339.html?> (site visited: Aug. 2021) (Year: 2012).

Ripple Cups, Ripple Coffee Cups, Rippie Paper Cups in Stock—U LINE [online] URL: https://www.uline.com/BL_594/Uline-Ripple-Insulated-Cups (site visited: Aug. 2021) (Year: 2020).

* cited by examiner

Primary Examiner — Jae Liang
 Assistant Examiner — Tia Ruth-Renee Polidori
 (74) Attorney, Agent, or Firm — Janeway Patent Law, PLLC; John M. Janeway

(57) CLAIM

We claim the ornamental design for a cup with lid, as shown and described.

DESCRIPTION

FIG. 1 shows a perspective view of a first embodiment of a cup with lid showing our new design.
 FIG. 2 shows an enlarged rear, elevation view of a lid component thereof with the cup portion removed for ease of illustration.

FIG. 3 shows an enlarged front, elevation view thereof.
FIG. 4 shows an enlarged left, elevation view thereof.
FIG. 5 shows an enlarged right, elevation view thereof.
FIG. 6 shows an enlarged top, plan view thereof.
FIG. 7 shows an enlarged bottom, plan view thereof.
FIG. 8 shows an enlarged cross-sectional view thereof.
FIG. 9 shows a perspective view of a first embodiment of a cup component thereof with the lid portion removed for ease of illustration.
FIG. 10 shows a rear, elevation view thereof.
FIG. 11 shows a front, elevation view thereof.
FIG. 12 shows a left, elevation view thereof.
FIG. 13 shows a right, elevation view thereof.
FIG. 14 shows a top, plan view thereof.
FIG. 15 shows a bottom, plan view thereof.
FIG. 16 shows a perspective view of a second embodiment of a cup component thereof with the lid portion removed for ease of illustration.
FIG. 17 shows a rear, elevation view thereof.
FIG. 18 shows a front, elevation view thereof.
FIG. 19 shows a left, elevation view thereof.
FIG. 20 shows a right, elevation view thereof.
FIG. 21 shows a top, plan view thereof; and,
FIG. 22 shows a bottom, plan view thereof.
The broken lines in FIGS. 15 and 22 are for the sole purpose of showing portions of the cup of the cup with lid, and do not form a part of the claimed design. The broken lines in FIG. 6 represent cross-sectional indicia and form no part of the claimed design.

1 Claim, 12 Drawing Sheets

FIG. 1

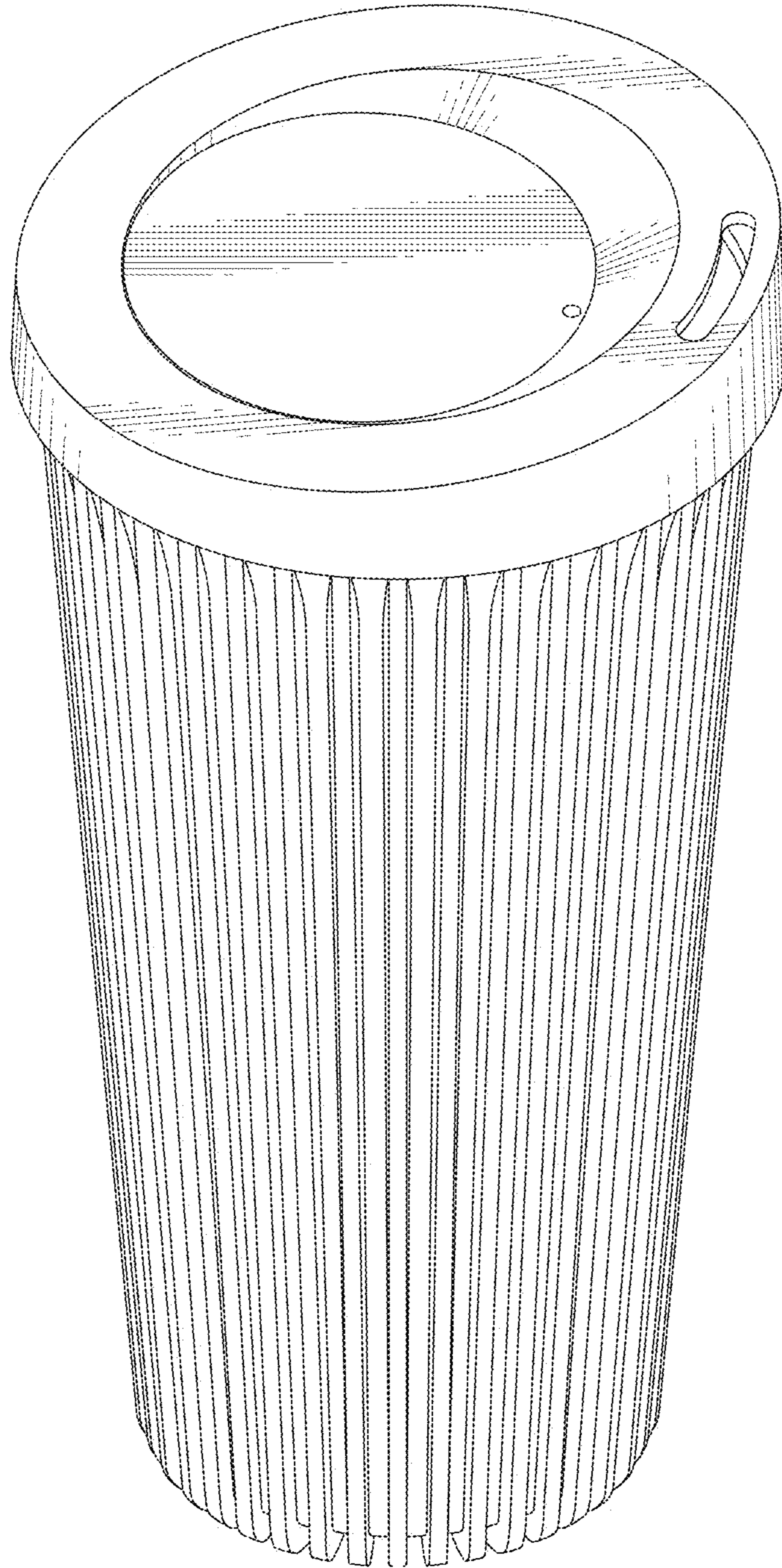

FIG. 2

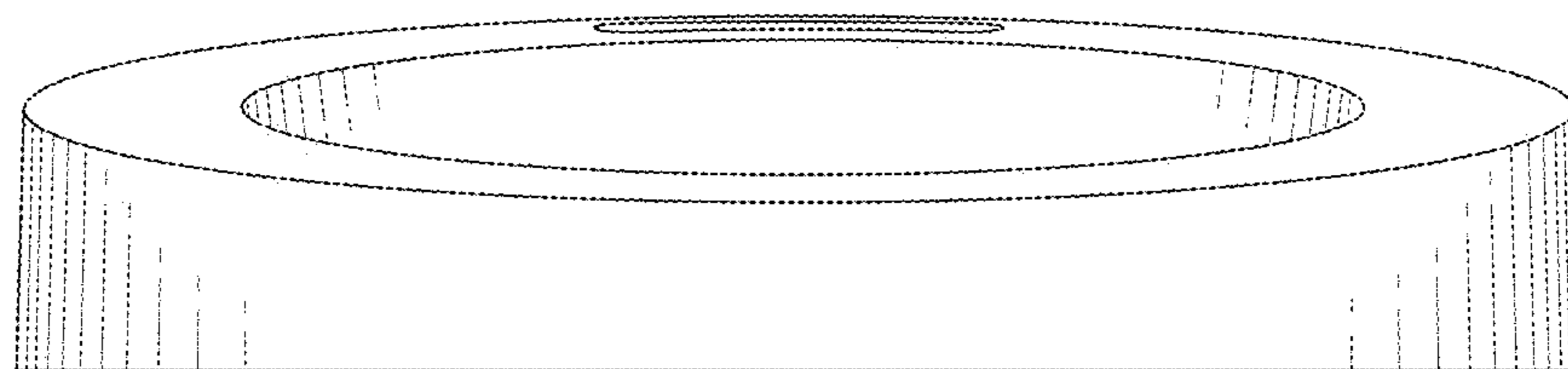

FIG. 3

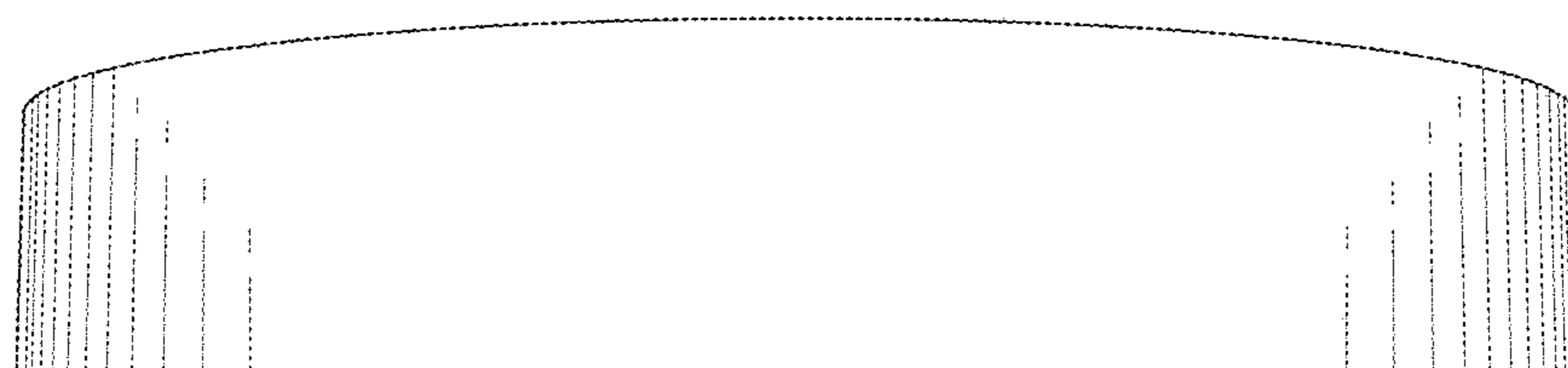

FIG. 4

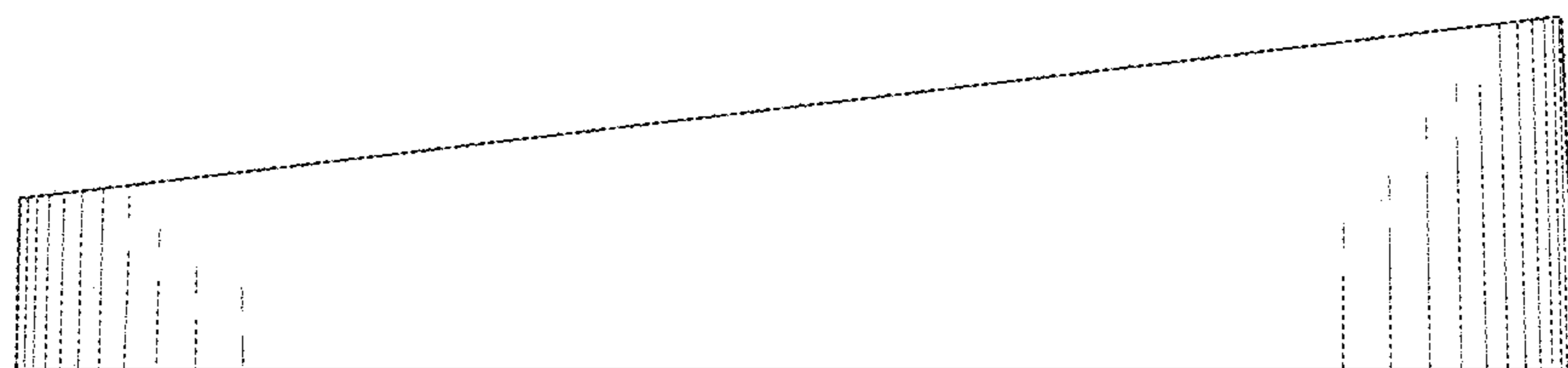

FIG. 5

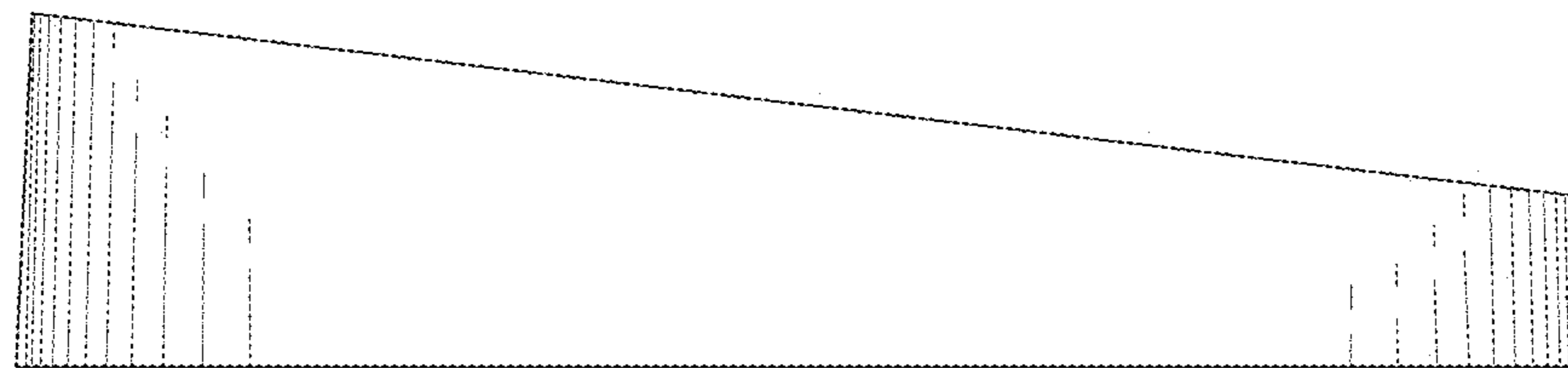

FIG. 6

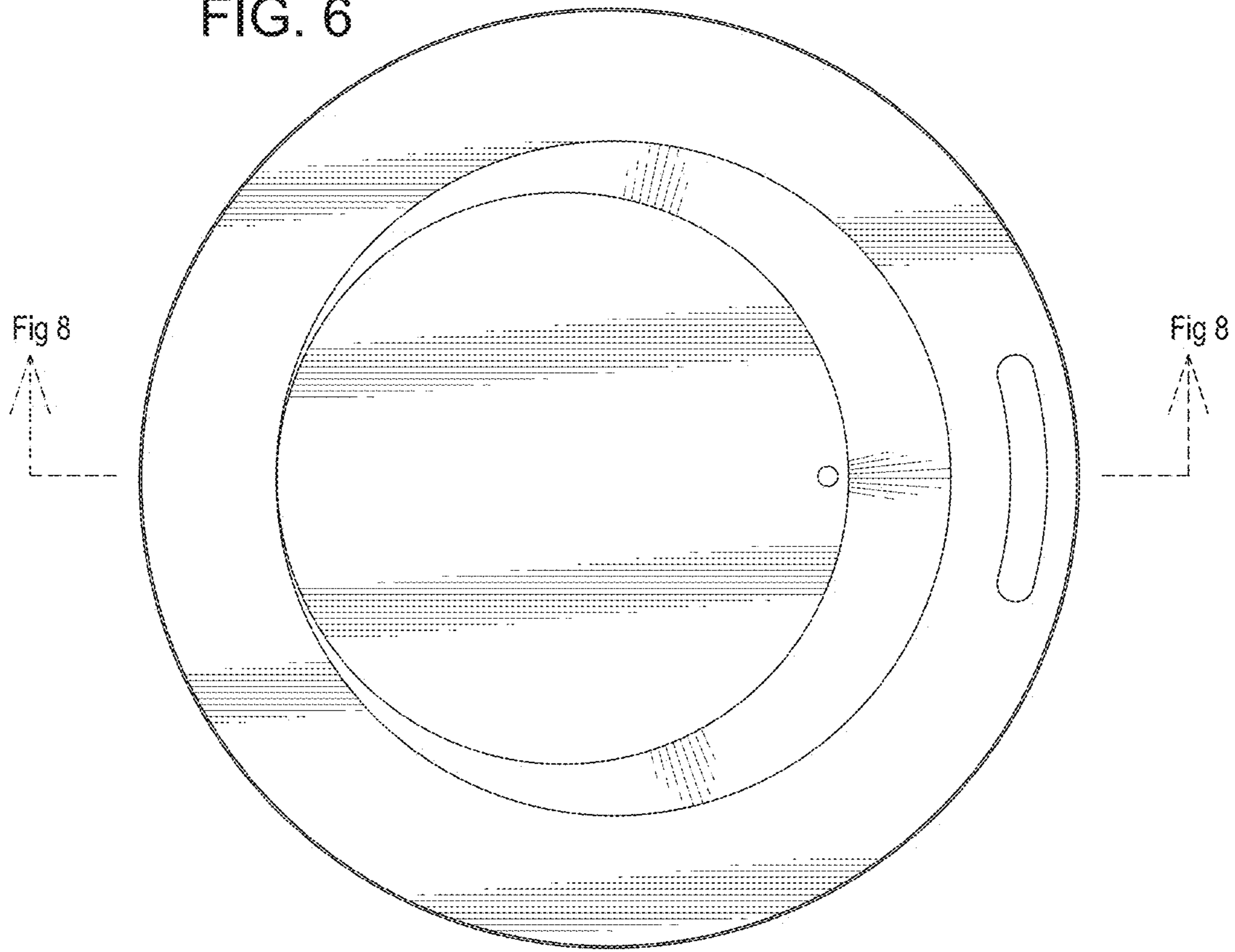

FIG. 7

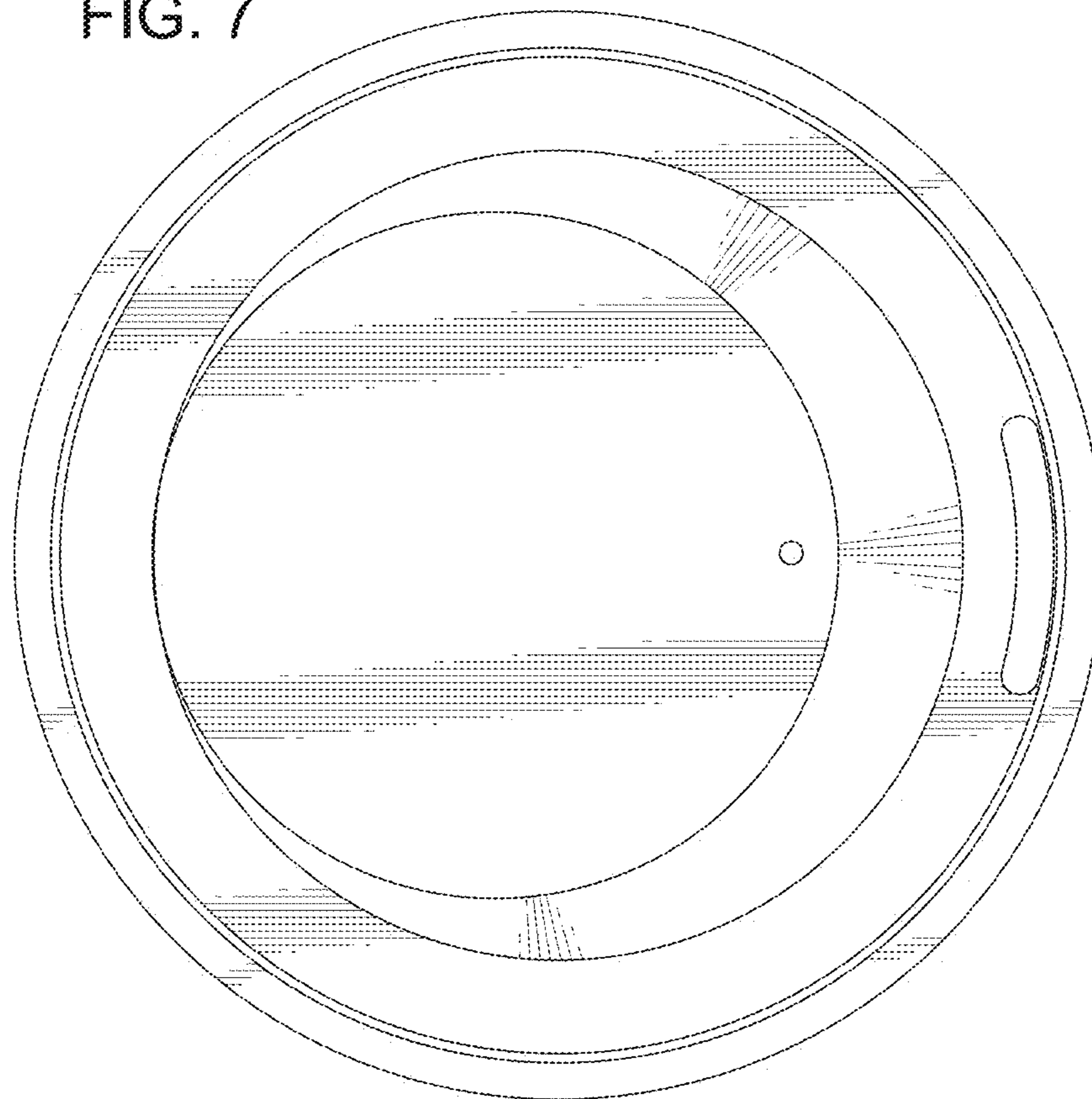

FIG. 8

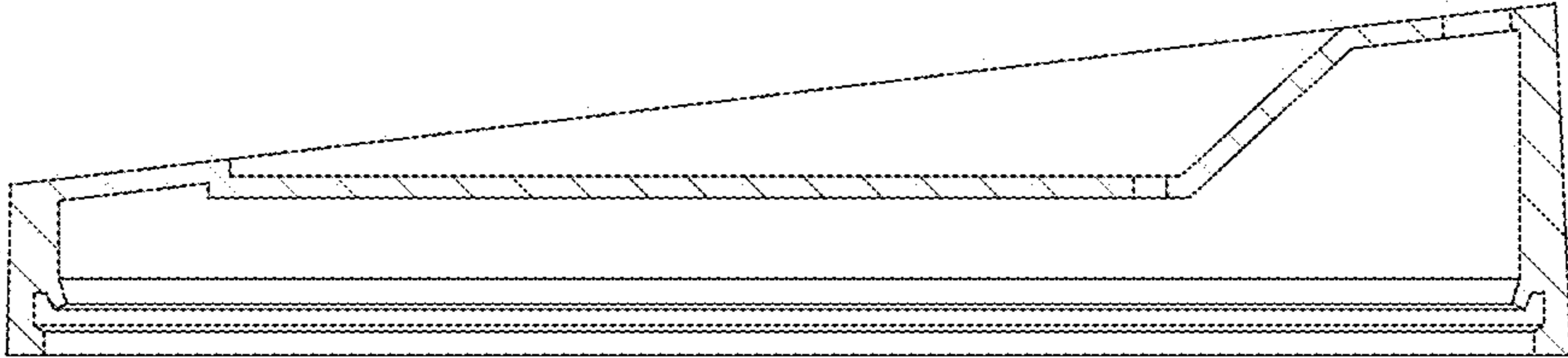

FIG. 9

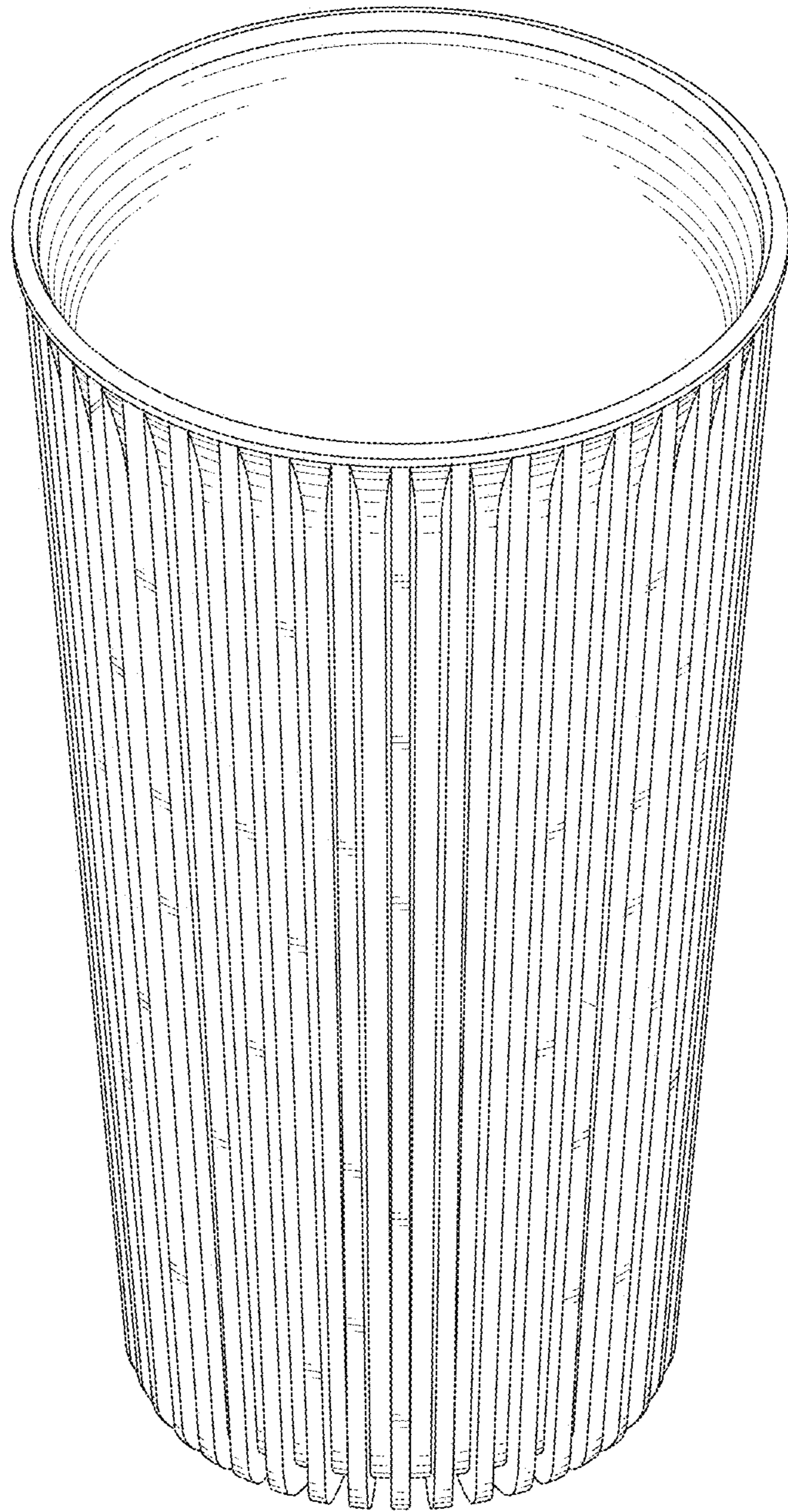

FIG. 11

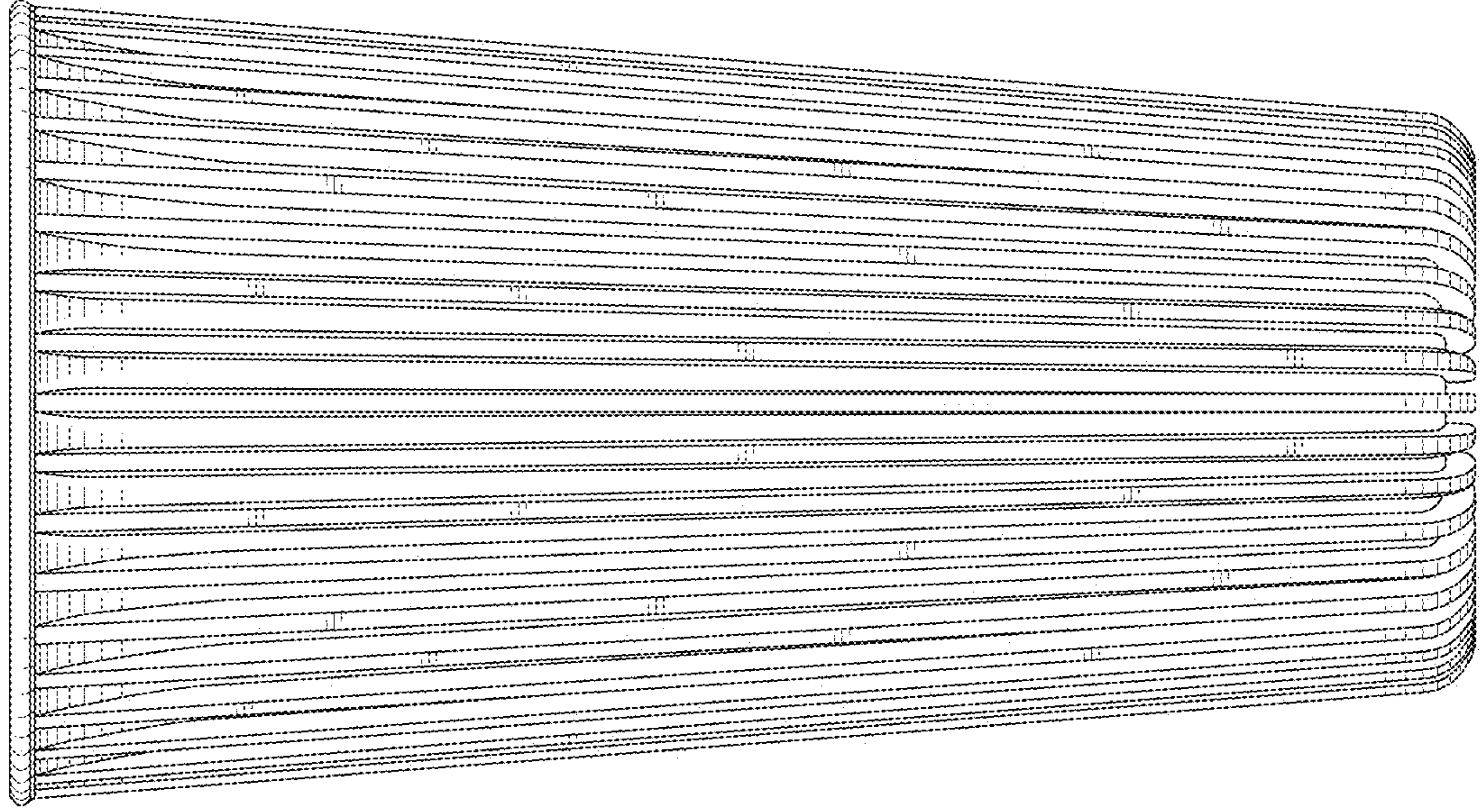

FIG. 10

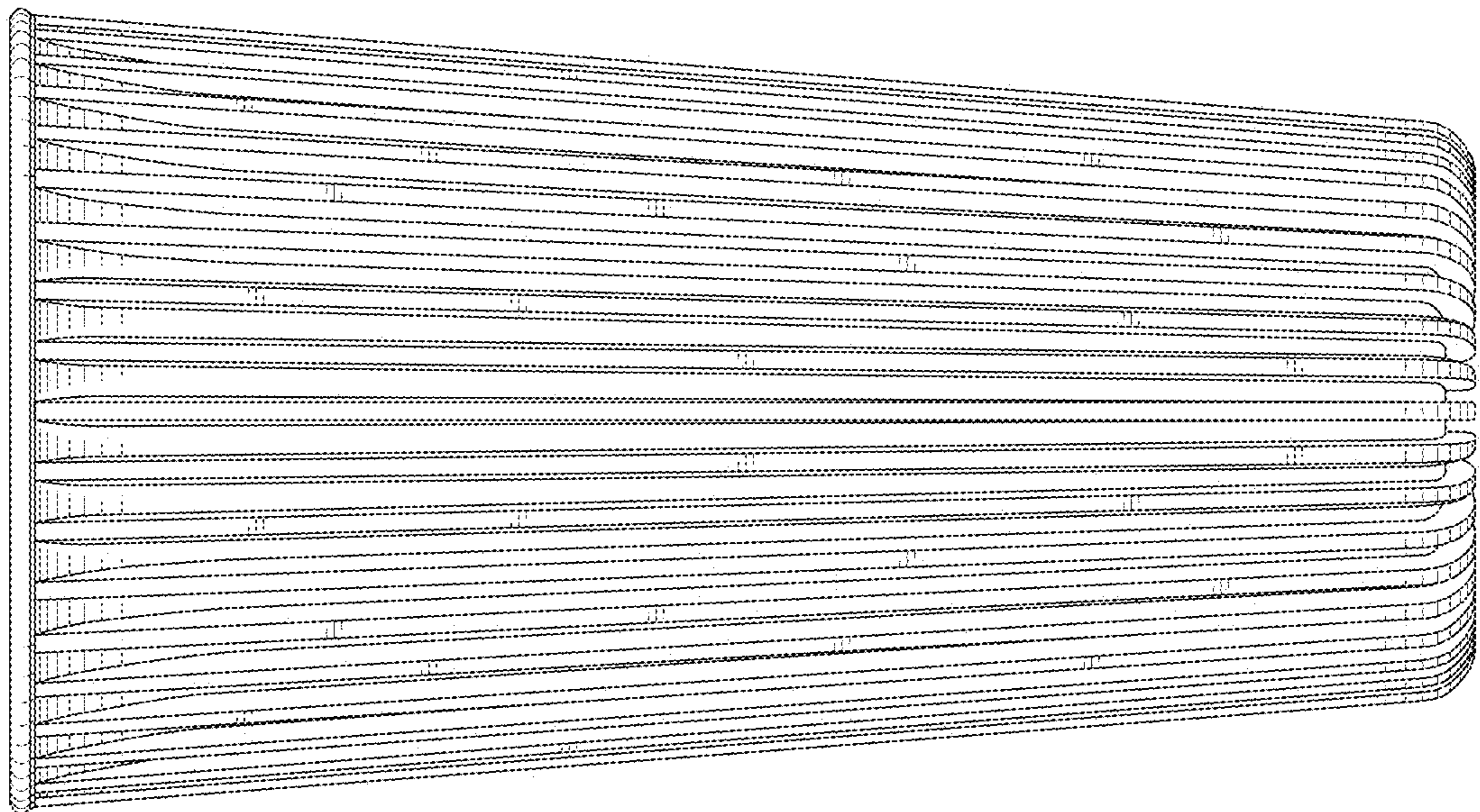

FIG. 13

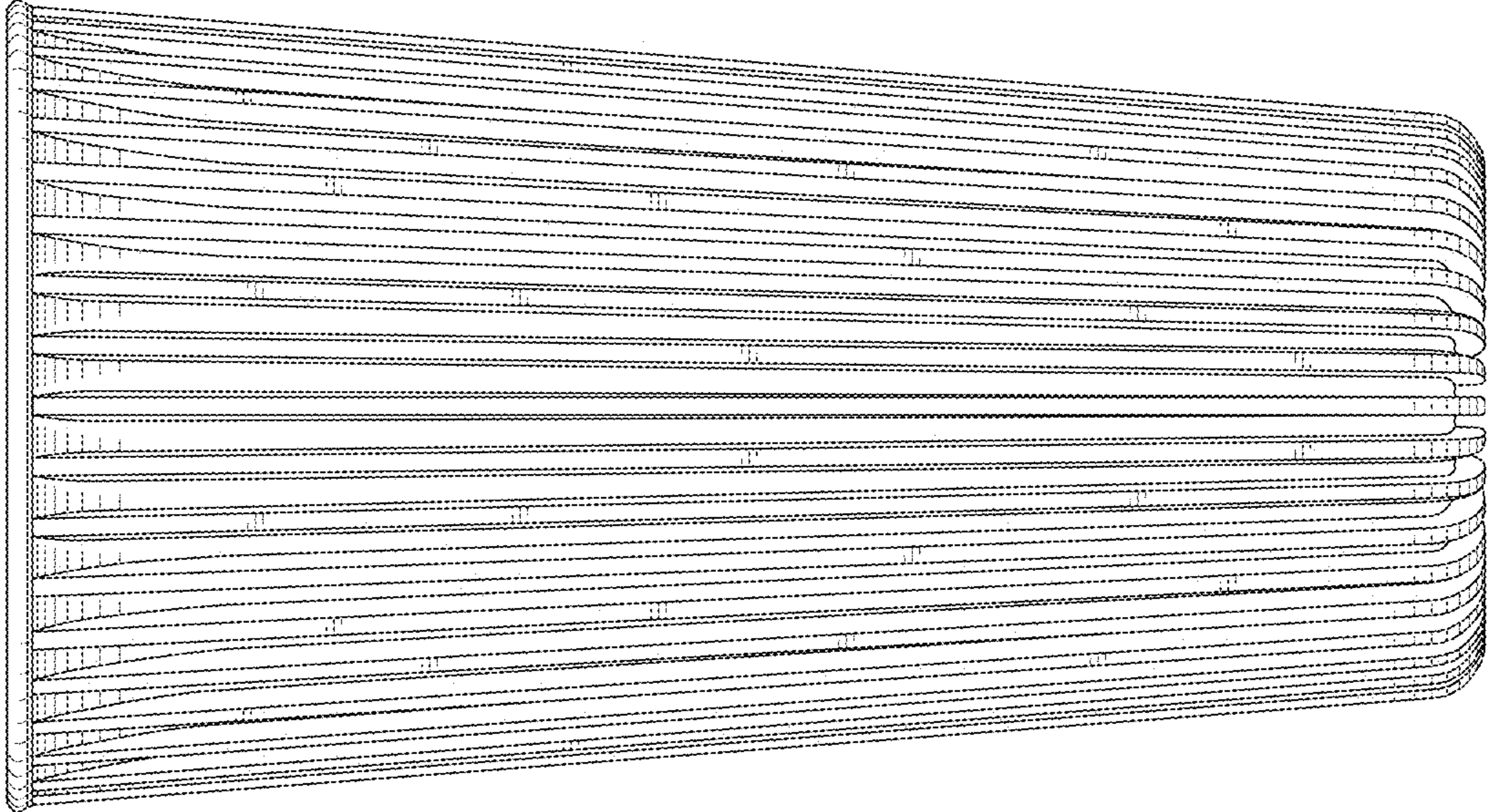

FIG. 12

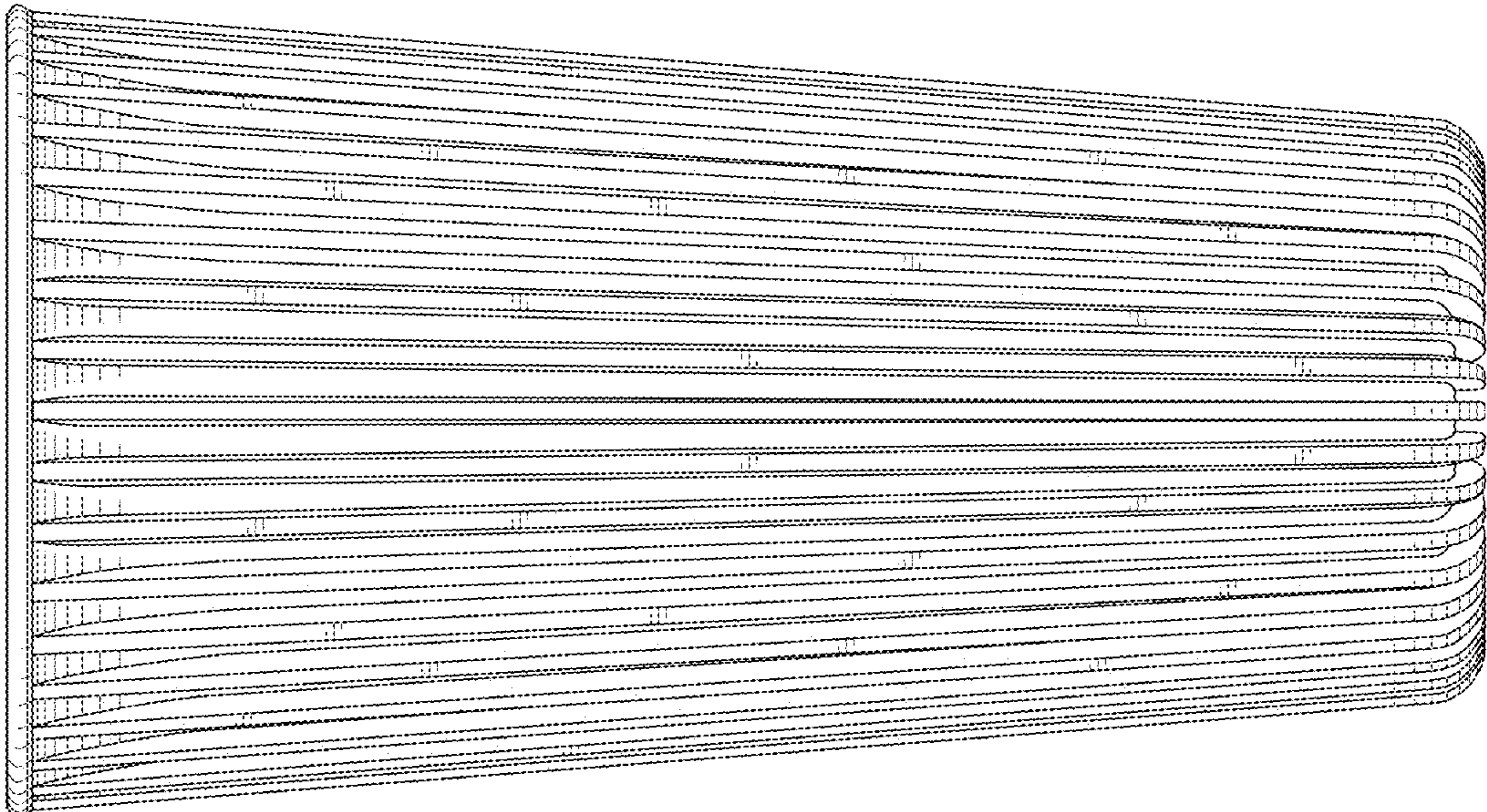

FIG. 14

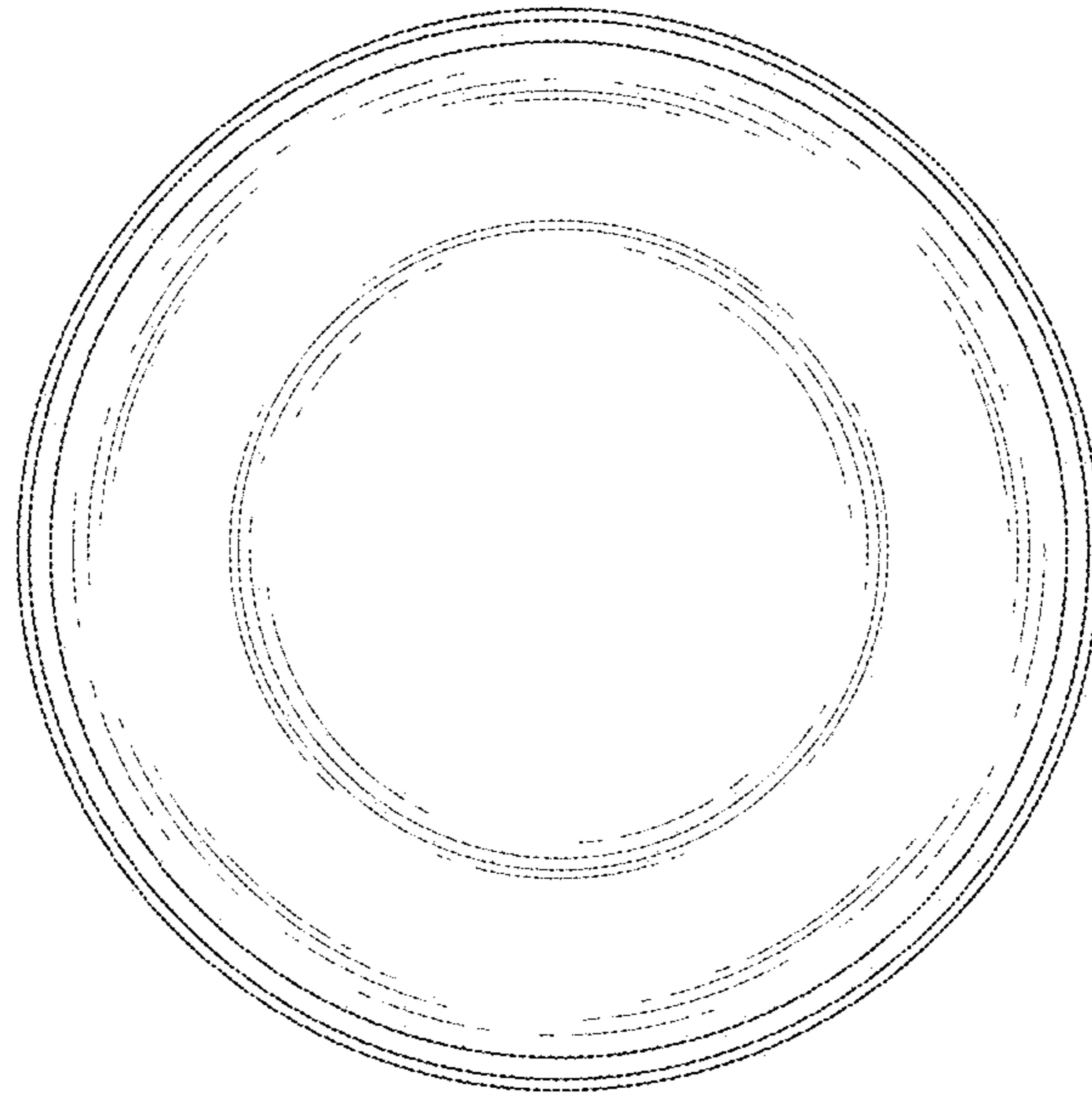

FIG. 15

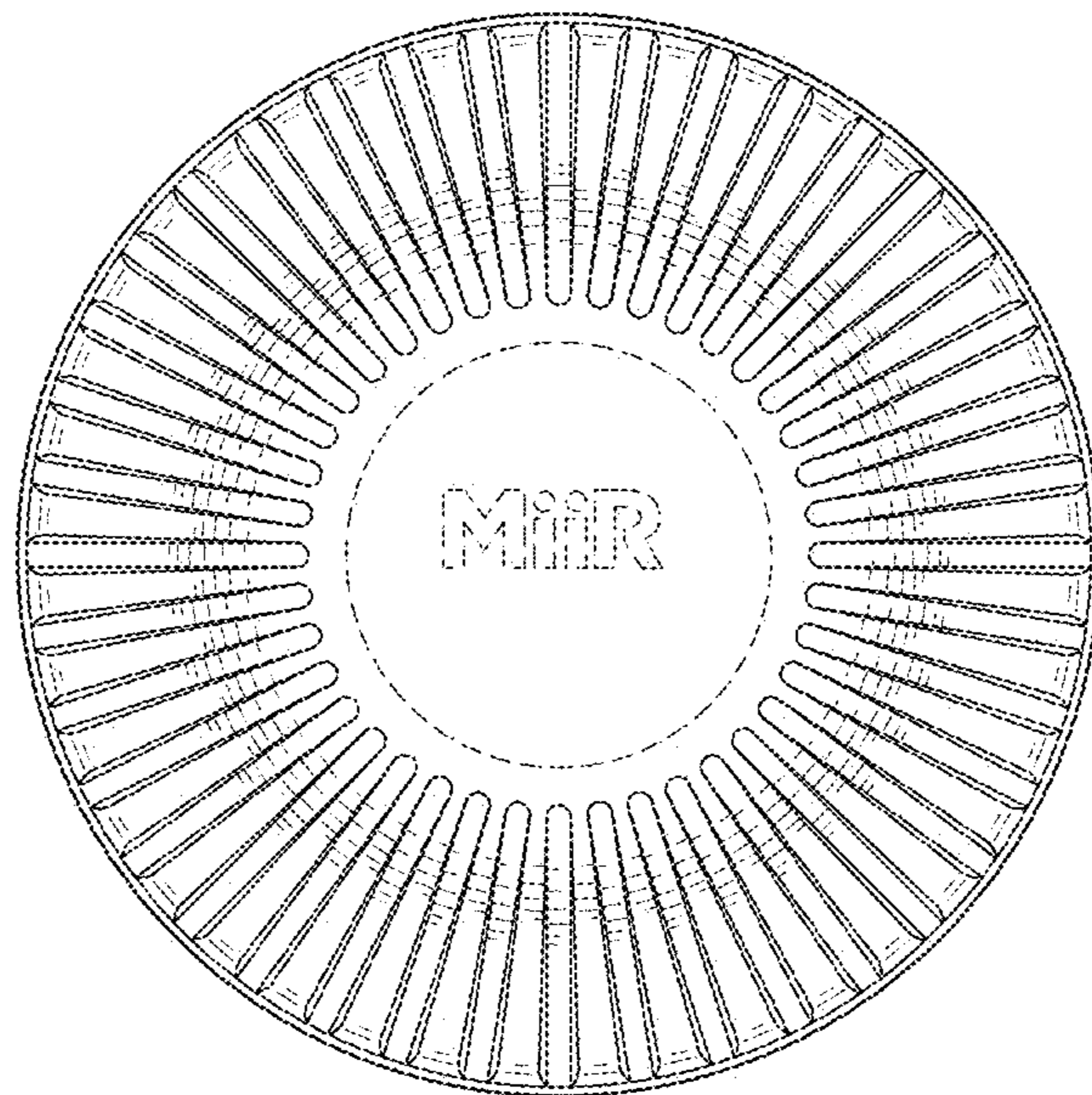

FIG. 16

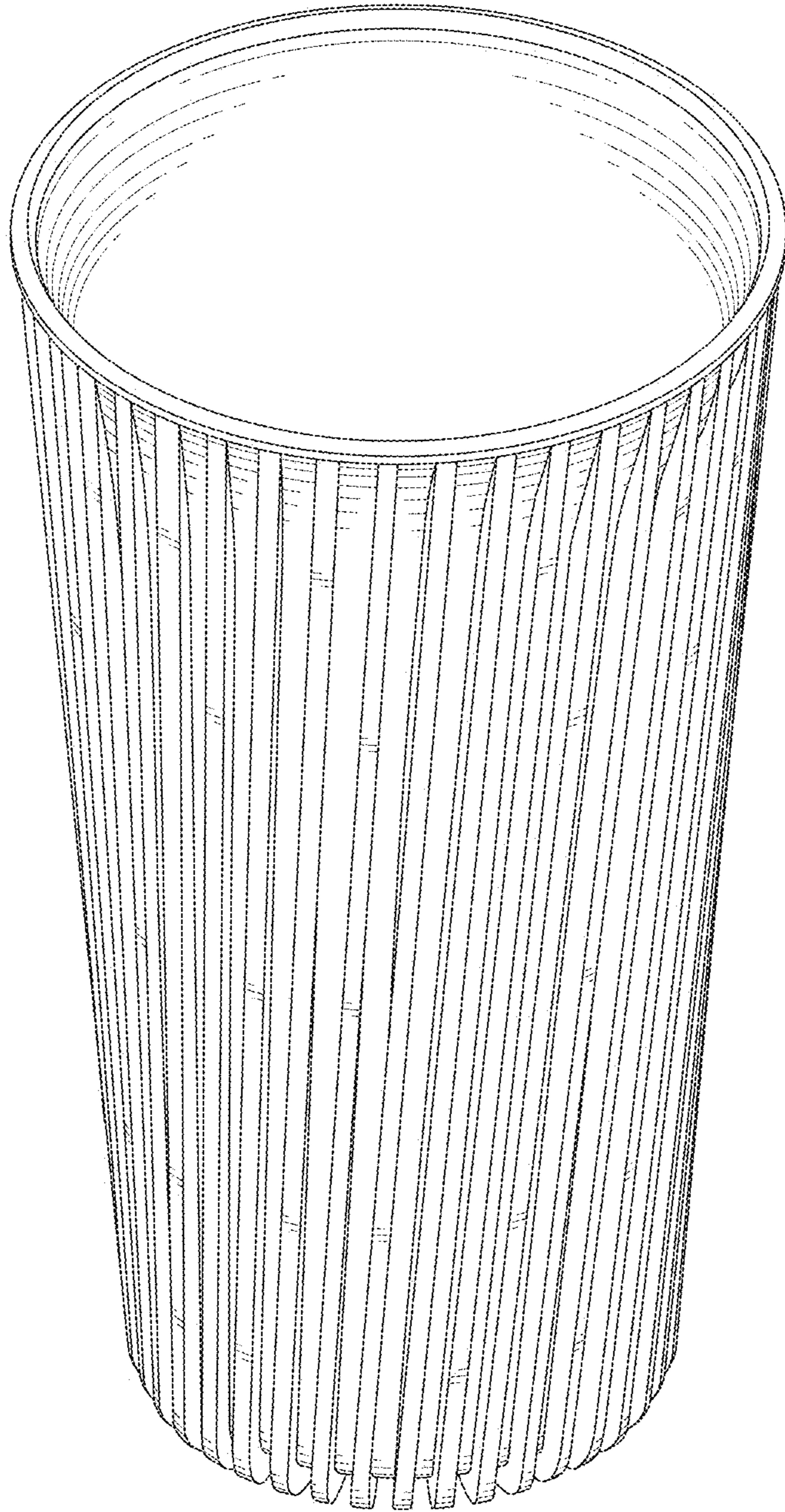

FIG. 18

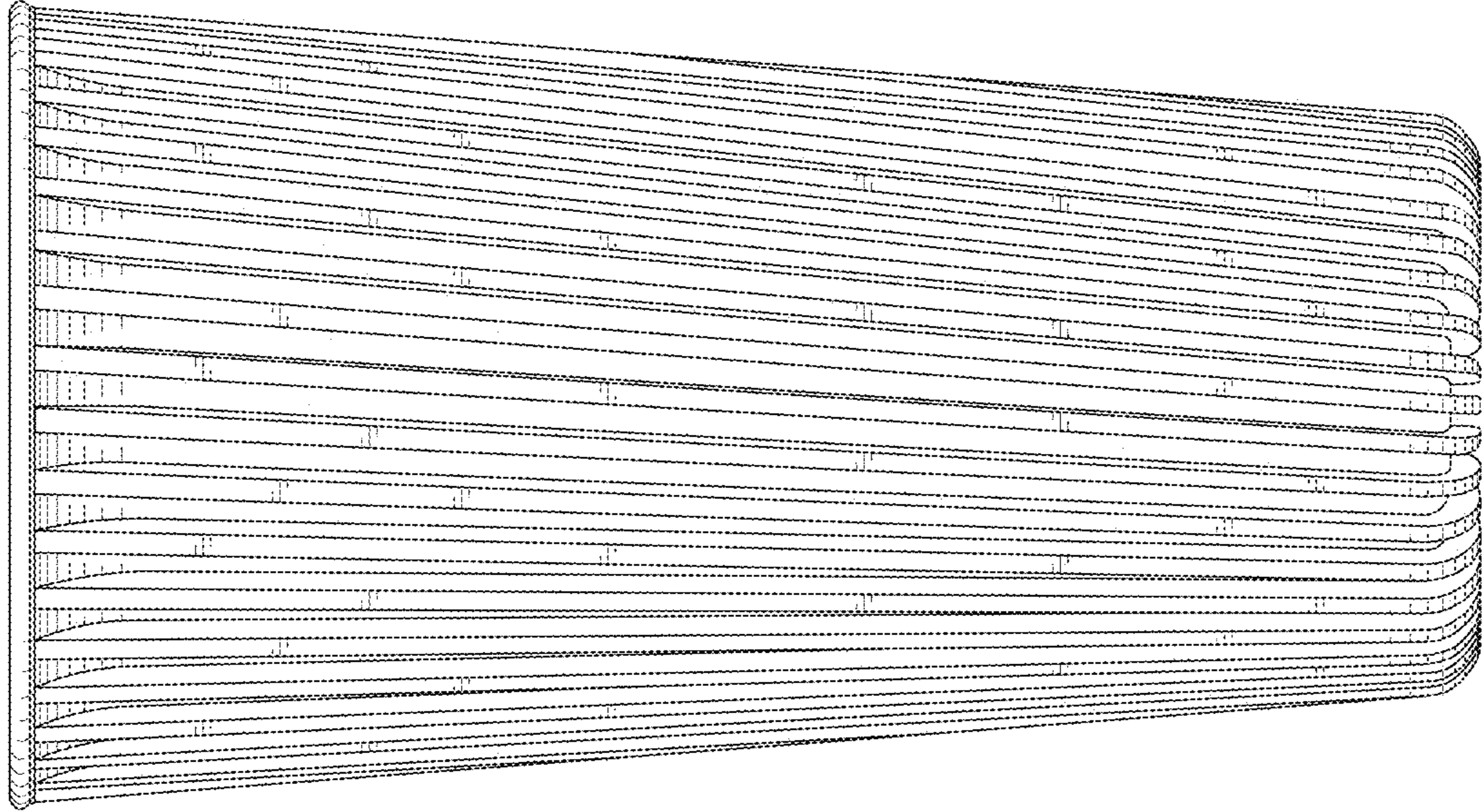

FIG. 17

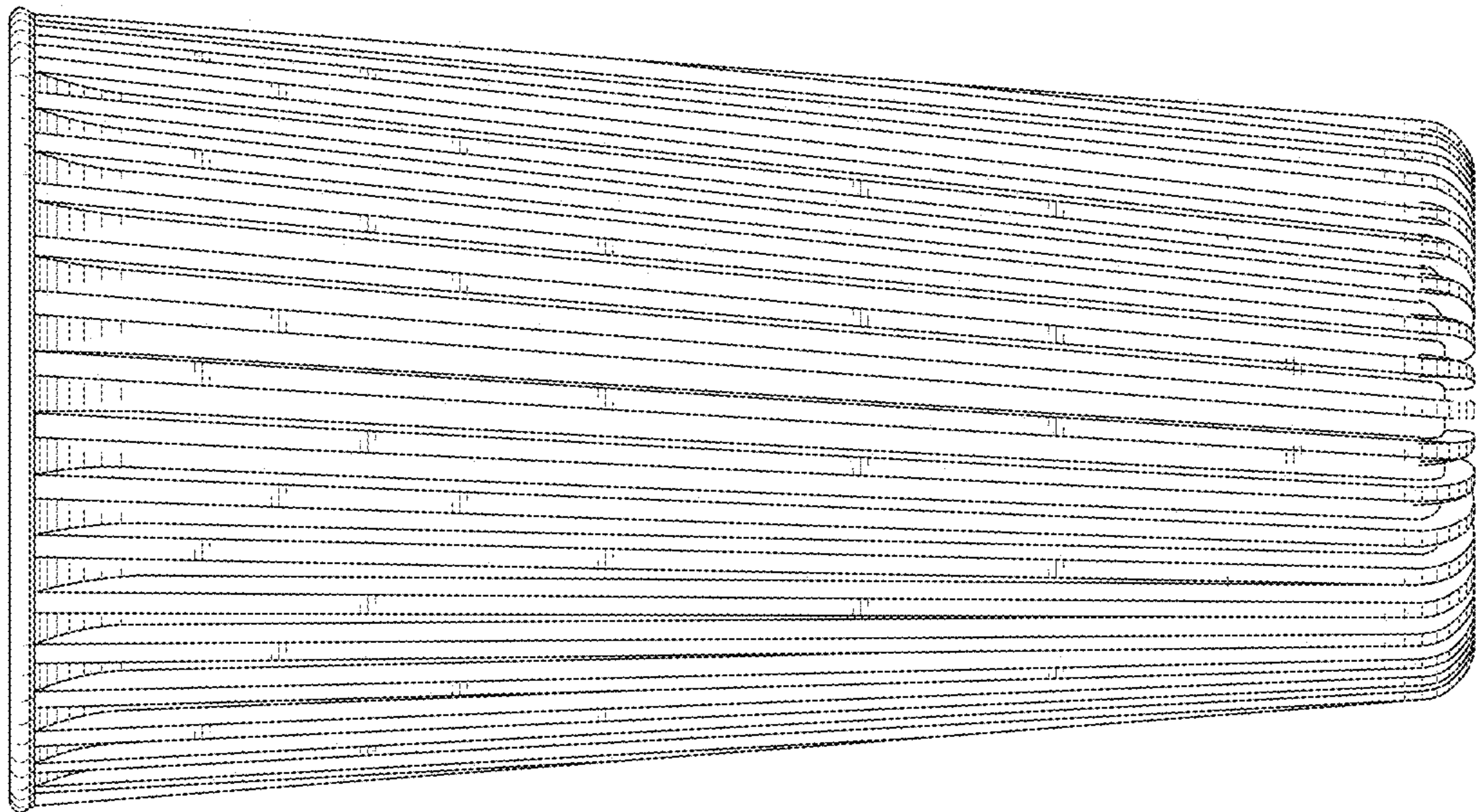

FIG. 20

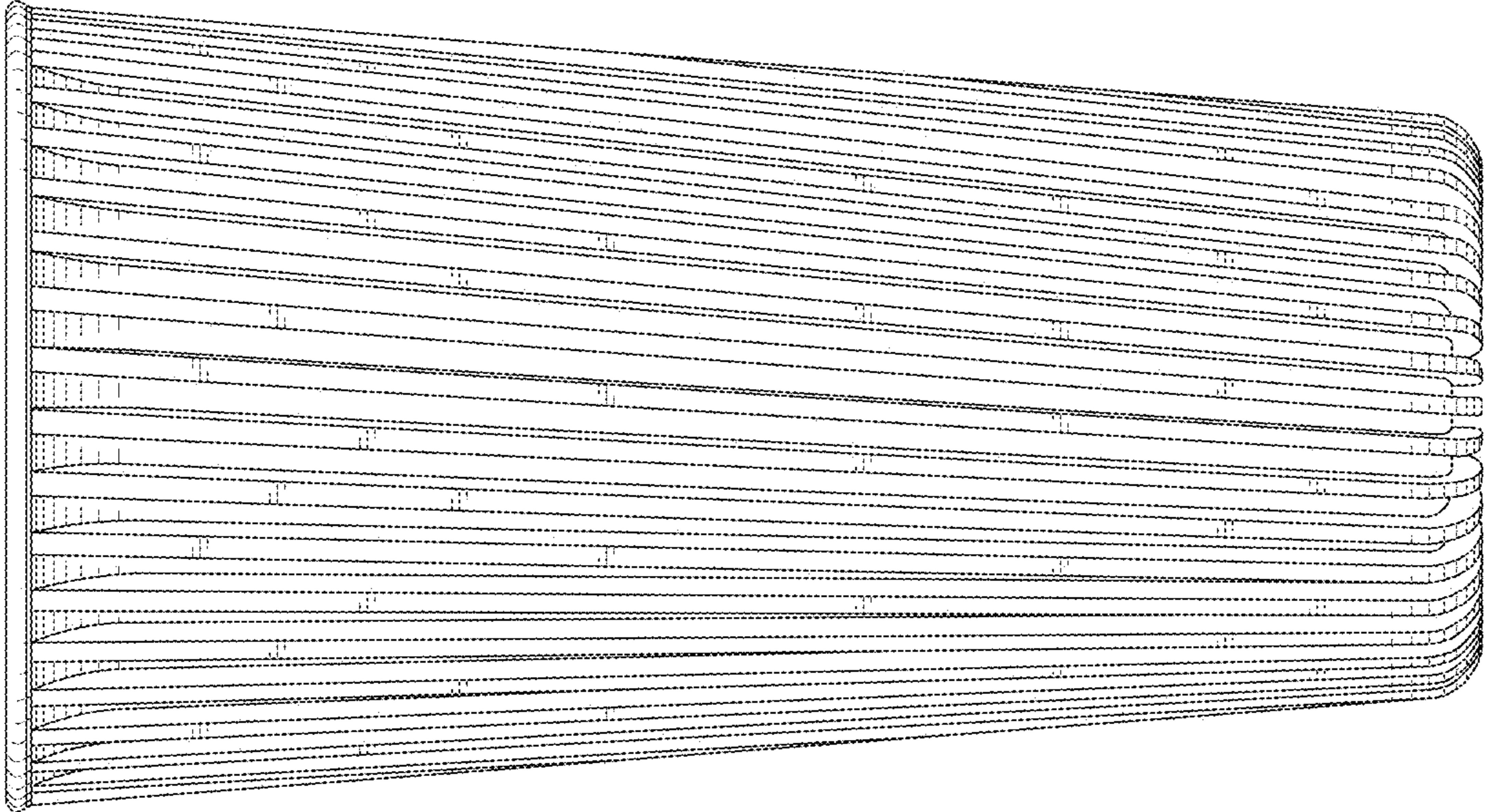

FIG. 19

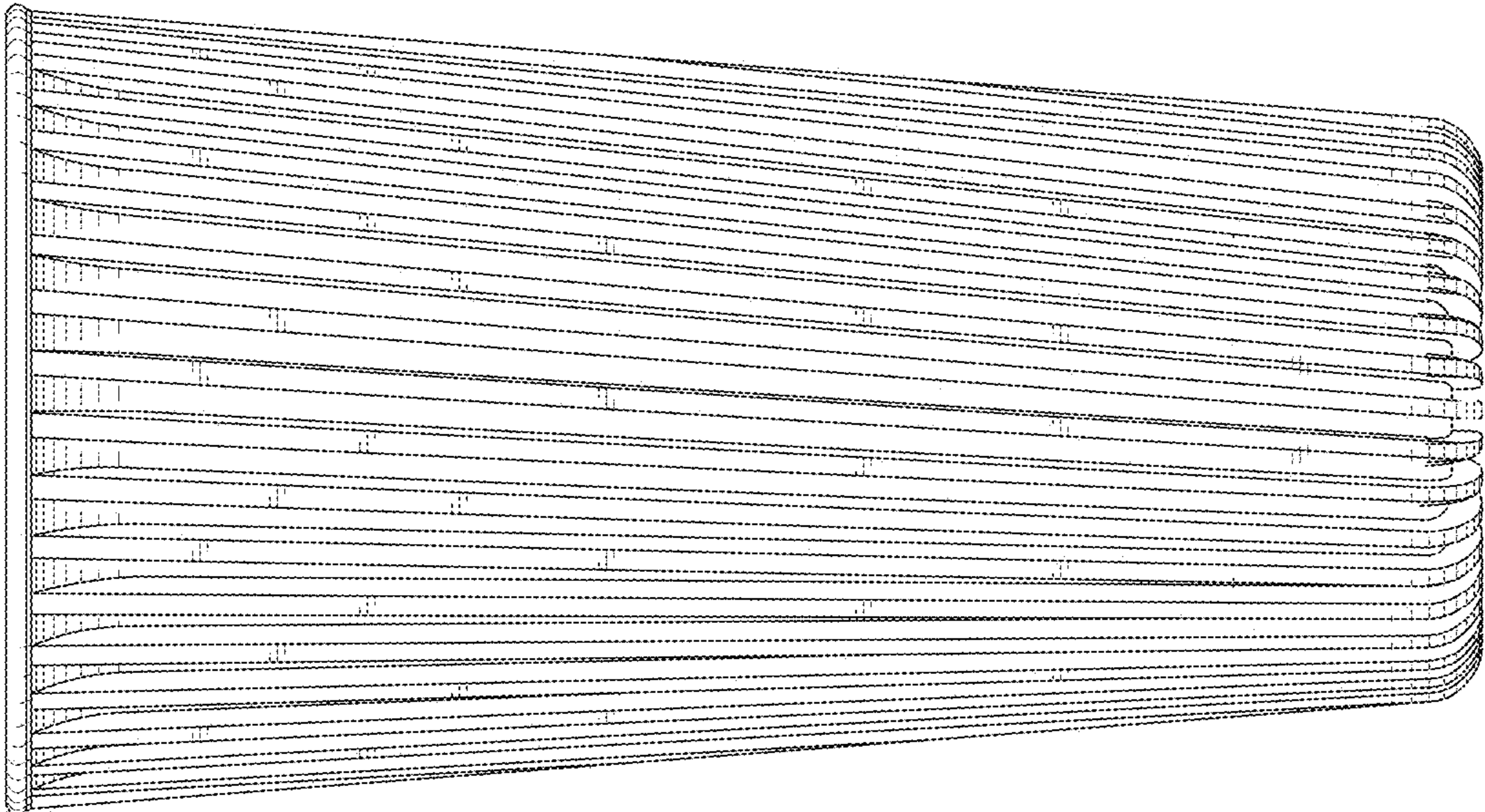

FIG. 21

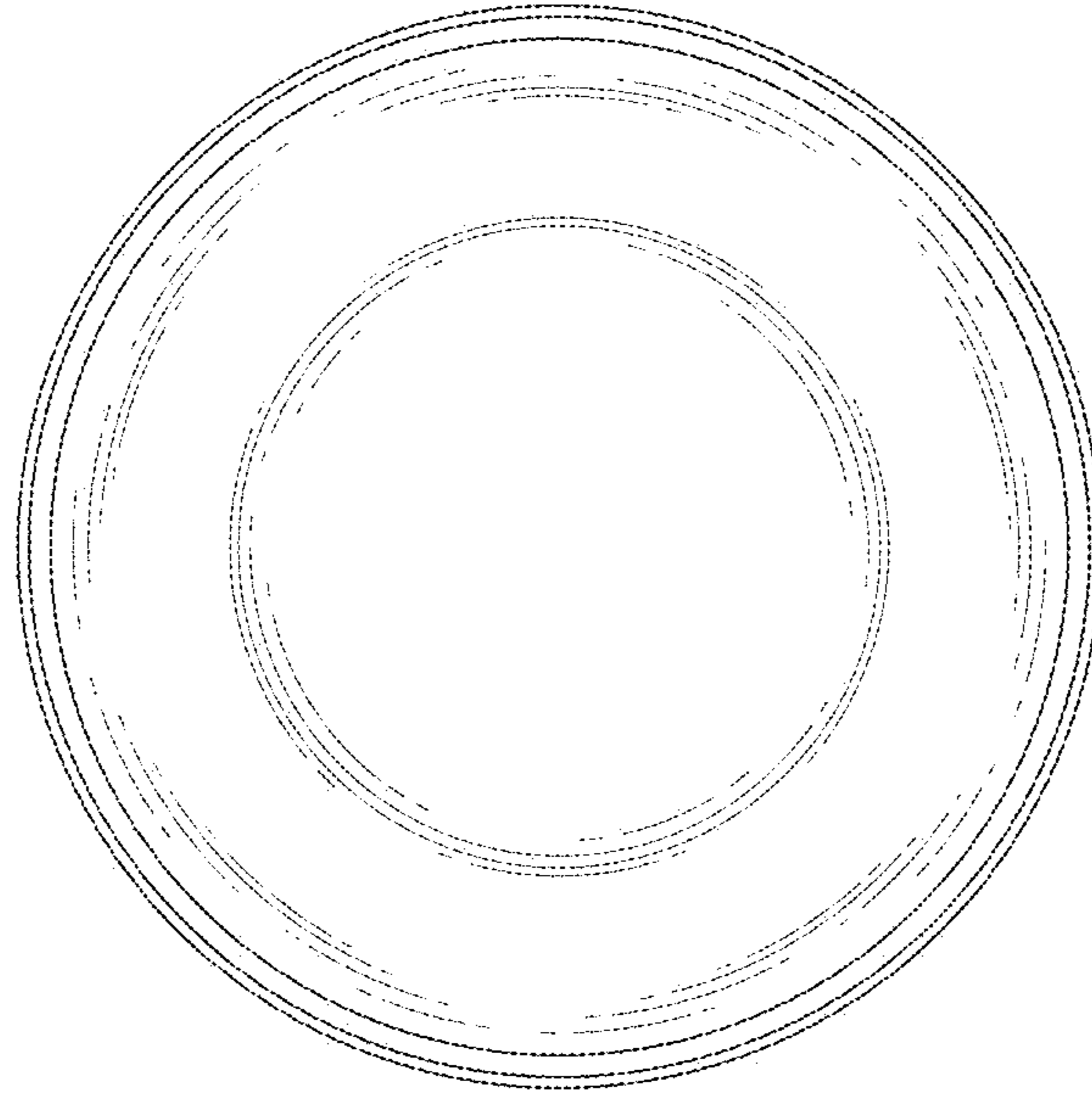

FIG. 22

