



US00D946304S

(12) **United States Design Patent** (10) **Patent No.:** **US D946,304 S**  
**Asis** (45) **Date of Patent:** **\*\* Mar. 22, 2022**

(54) **TOILET PAPER STAND** 6,988,691 B1 \* 1/2006 Lai ..... A47K 10/38  
 242/594  
 (71) Applicant: **Umbra LLC**, Buffalo, NY (US) D533,750 S \* 12/2006 Goodman ..... A47K 10/38  
 D7/601  
 (72) Inventor: **Nathan Asis**, Richmond Hill (CA) D546,583 S \* 7/2007 Snell ..... A47K 10/38  
 D6/677.5  
 (73) Assignee: **UMBRA LLC**, Buffalo, NY (US) D694,069 S \* 11/2013 Goodman ..... D7/601  
 D753,941 S \* 4/2016 Boen ..... D6/681.1  
 D766,046 S \* 9/2016 Guindi ..... D7/601  
 (\*\*) Term: **15 Years** 2012/0234963 A1 \* 9/2012 Channel ..... A47K 10/38  
 242/560.2

(21) Appl. No.: **35/001,951**

(22) Filed: **Oct. 20, 2020**

(80) **Hague Agreement Data**

Int. Filing Date: **Oct. 20, 2020**  
 Int. Reg. No.: **DM/212095**  
 Int. Reg. Date: **Oct. 20, 2020**  
 Int. Reg. Pub. Date: **Jan. 15, 2021**

(51) **LOC (13) Cl.** ..... **23-03**

(52) **U.S. Cl.**  
 USPC ..... **D6/523**

(58) **Field of Classification Search**

USPC ..... D6/512, 515, 518-521, 523, 524, 527,  
 D6/677.5, 682.1, 682.5  
 CPC ..... A47K 10/00; A47K 10/16; A47K 10/22;  
 A47K 10/24; A47K 10/32; A47K 10/38  
 See application file for complete search history.

(56) **References Cited**

**U.S. PATENT DOCUMENTS**

6,405,973 B1 \* 6/2002 Hollinger ..... A47K 10/38  
 242/591  
 D493,643 S \* 8/2004 Snell ..... D6/523

\* cited by examiner

*Primary Examiner* — Mary Ann Calabrese  
 (74) *Attorney, Agent, or Firm* — Simpson & Simpson,  
 PLLC

(57) **CLAIM**

The ornamental design for a toilet paper stand, as shown and described.

**DESCRIPTION**

1 Toilet paper stand  
 1.1 : Perspective  
 1.2 : Front  
 1.3 : Back  
 1.4 : Left  
 1.5 : Right  
 1.6 : Top  
 1.7 : Bottom

**1 Claim, 7 Drawing Sheets**

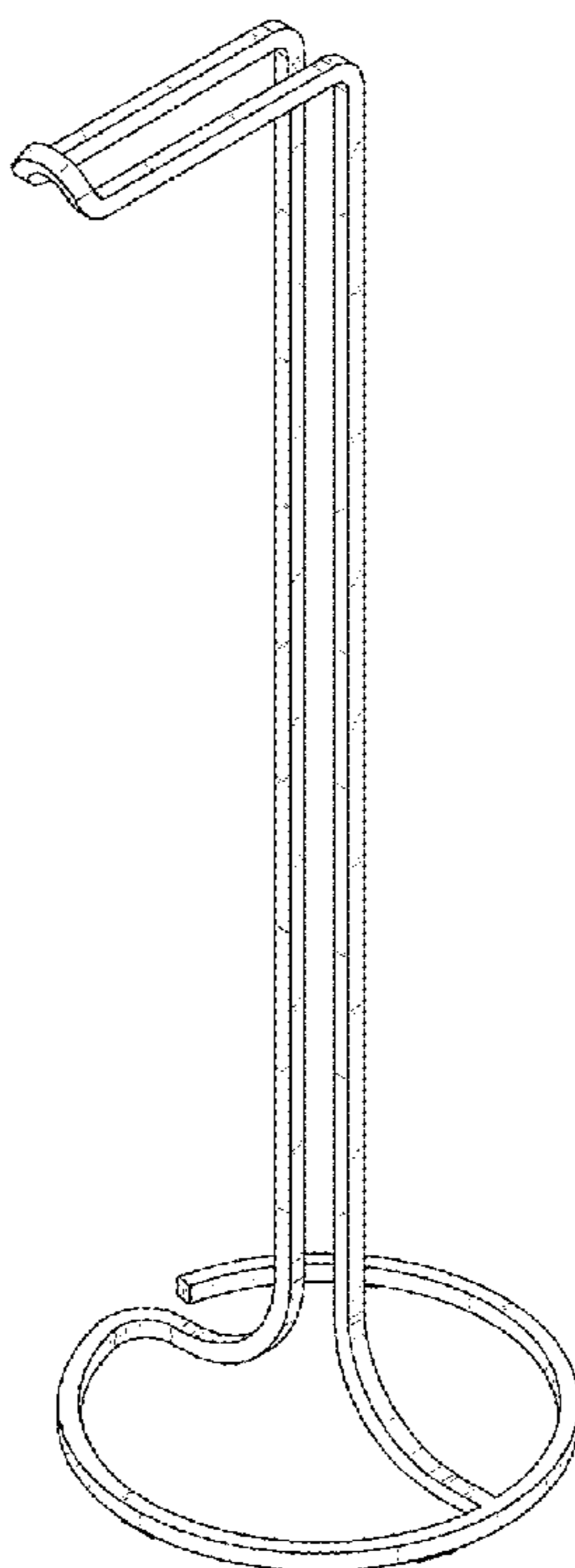

1.1

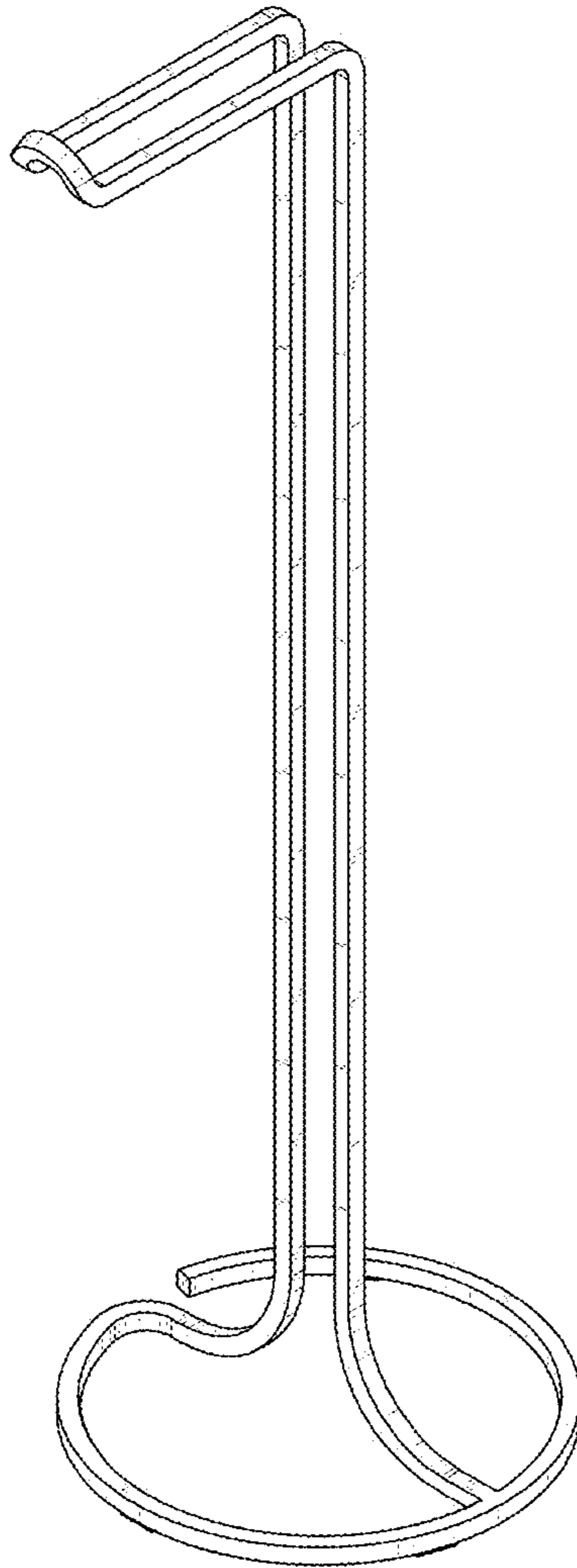

1.2

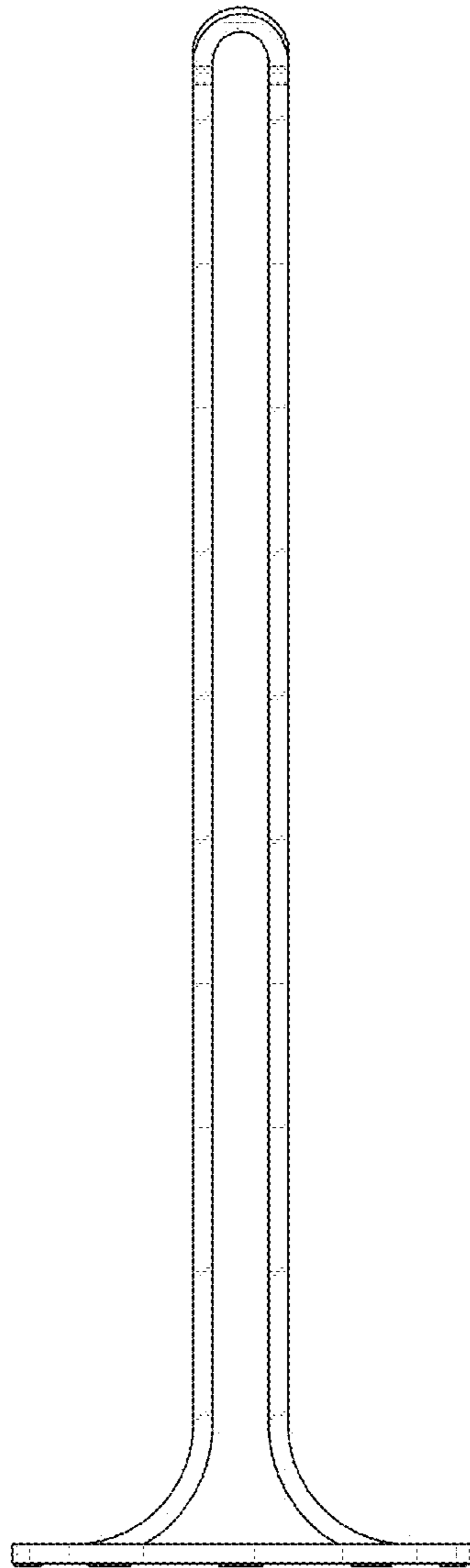

1.3

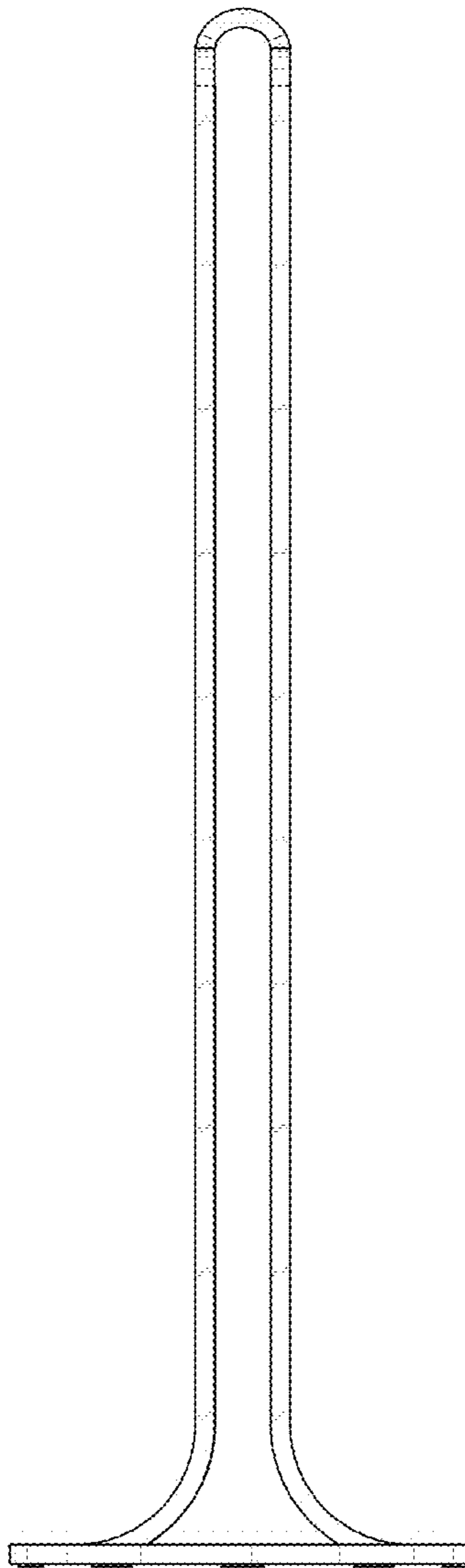

1.4

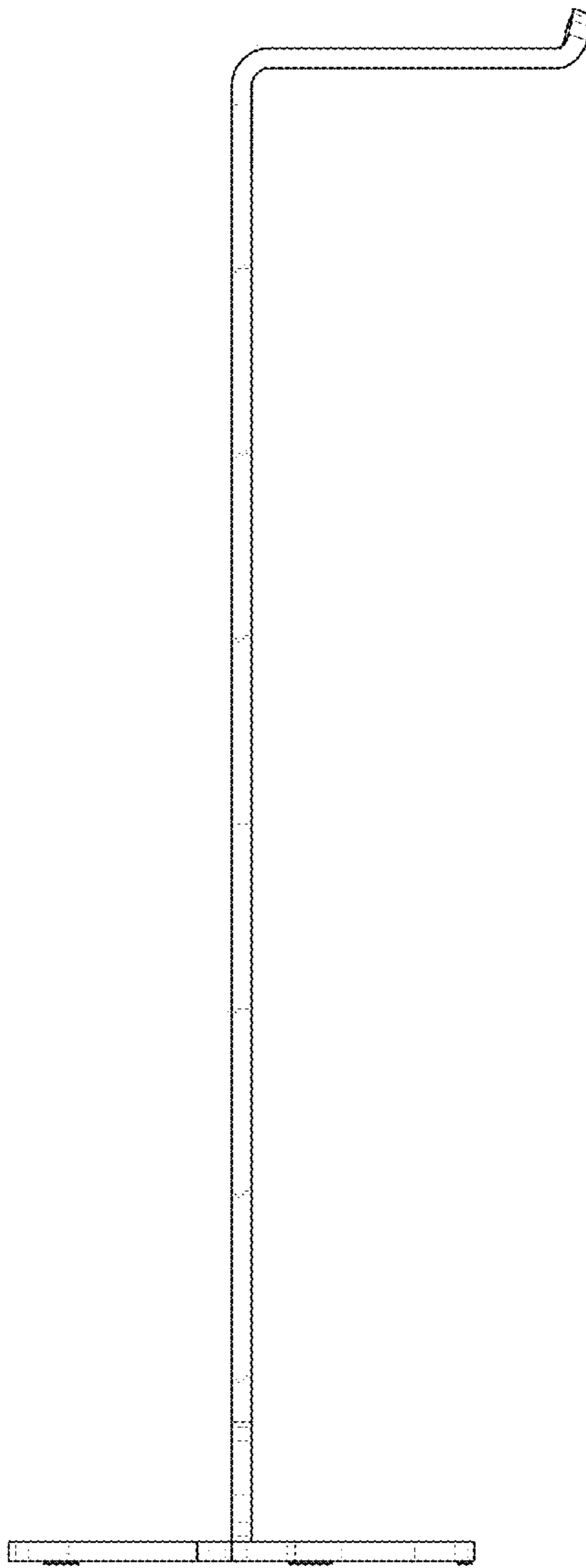

1.5

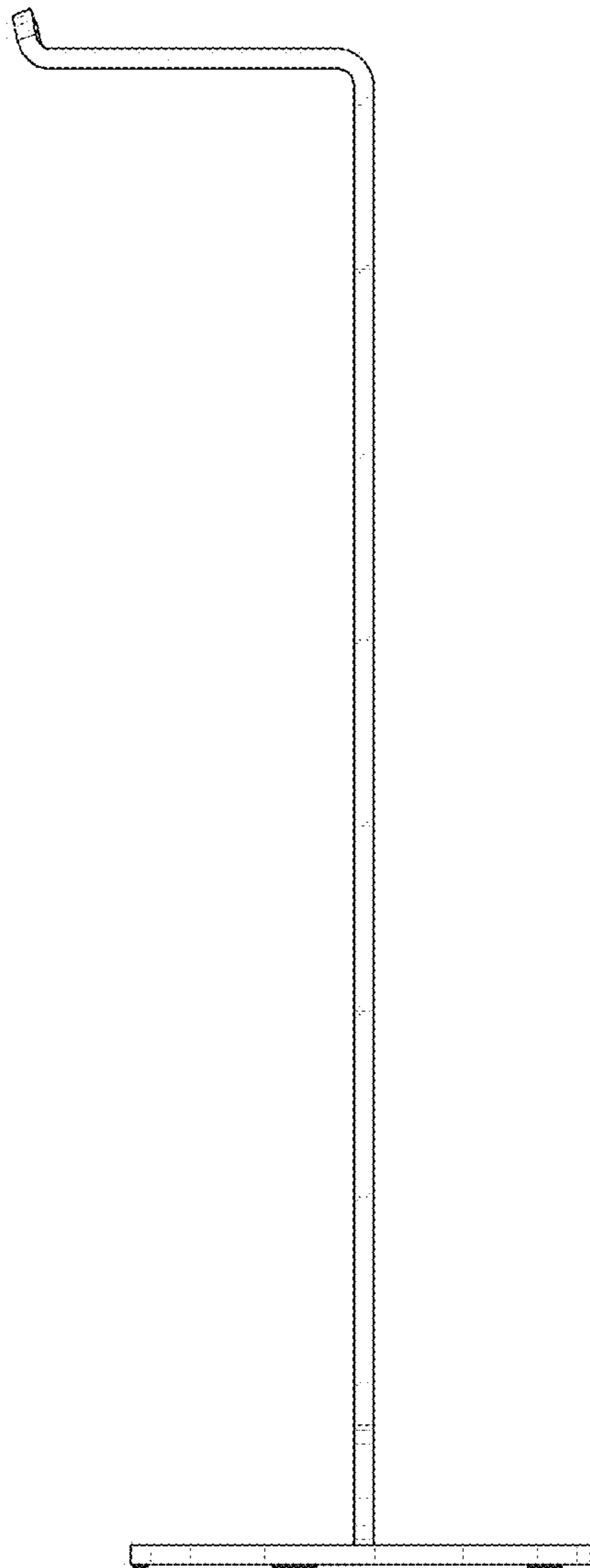

1.6

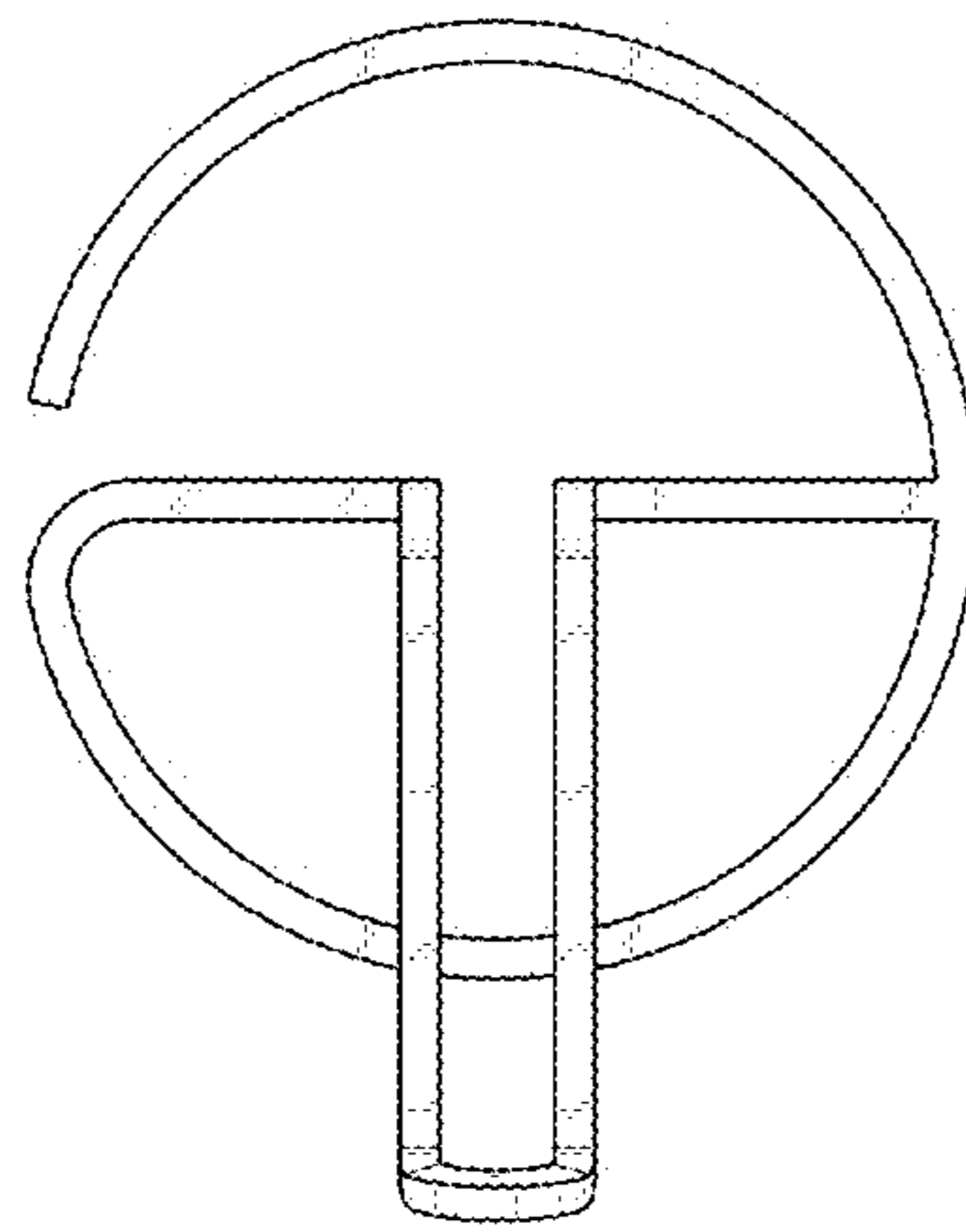

1.7

