



US00D946266S

(12) **United States Design Patent**
Zhou

(10) **Patent No.:** **US D946,266 S**
(45) **Date of Patent:** **** Mar. 22, 2022**

(54) **BACKPACK**

- (71) Applicant: **Zhongshan Zhou**, Guangzhou (CN)
- (72) Inventor: **Zhongshan Zhou**, Guangzhou (CN)
- (**) Term: **15 Years**
- (21) Appl. No.: **29/703,185**
- (22) Filed: **Aug. 26, 2019**

(51) **LOC (13) Cl.** **03-01**

(52) **U.S. Cl.**
USPC **D3/217**

(58) **Field of Classification Search**
USPC D3/201, 213–219, 221, 224, 225, 229,
D3/230, 232, 243–246, 254, 318
CPC .. A45C 3/08; A45C 3/06; A45C 13/08; A45C
13/02; A45C 7/0086; A45C 3/00; A45C
13/26; A45F 3/04; A45F 3/02
See application file for complete search history.

(56) **References Cited**

U.S. PATENT DOCUMENTS

D829,436 S *	10/2018	Benzon	D3/217
D836,326 S *	12/2018	Skaff	D3/217
D857,377 S *	8/2019	Hong	D3/217
D859,819 S *	9/2019	Mather	D3/217
D901,169 S *	11/2020	Thibadeau	D3/217
D911,024 S *	2/2021	Rabe	D3/217
D922,062 S *	6/2021	Shi	D3/217
2005/0258294 A1 *	11/2005	Dickson	A45F 4/04 242/388.3

OTHER PUBLICATIONS

Bopai, 15 inch Super Slim Laptop Backpack Men, reviewed on Amazon Jun. 2019, Aug. 3, 2021. Available online at URL: https://www.amazon.com/BOPAI-inch-Super-Laptop-Backpack/product-reviews/B07QYF9CW1/ref=cm_cr_ar_p_d_paging_btm_5?ie=UTF8&pageNumber=5&reviewerType=all_reviews.*
https://www.amazon.com/BOPAI-Laptop-Backpack-Waterproof-College/dp/B07QYF9CW1/ref=sr_1_5?keywords=bopai&qid=1564571337&s=gateway&sr=8-5#customerReviews; Apr. 20, 2019.

* cited by examiner

Primary Examiner — Jennifer L Watkins

(74) *Attorney, Agent, or Firm* — Rumit Ranjit Kanakia

(57) **CLAIM**

I claim the ornamental design for a backpack, as shown and described.

DESCRIPTION

FIG. 1 is a Perspective view of a backpack showing my new design;
FIG. 2 is a Front view of the backpack as shown in FIG. 1;
FIG. 3 is a Back view of the backpack as shown in FIG. 1;
FIG. 4 is a Top view of the backpack as shown in FIG. 1;
FIG. 5 is a Bottom view of the backpack as shown in FIG. 1;
FIG. 6 is a Right-side view of the backpack as shown in FIG. 1; and,
FIG. 7 is a Left-side view of the backpack as shown in FIG. 1.

The broken lines surrounding unshaded areas depict portions of the article and form no part of the claim. The broken lines shown on claimed surfaces depict stitching and form no part of the claim.

1 Claim, 7 Drawing Sheets

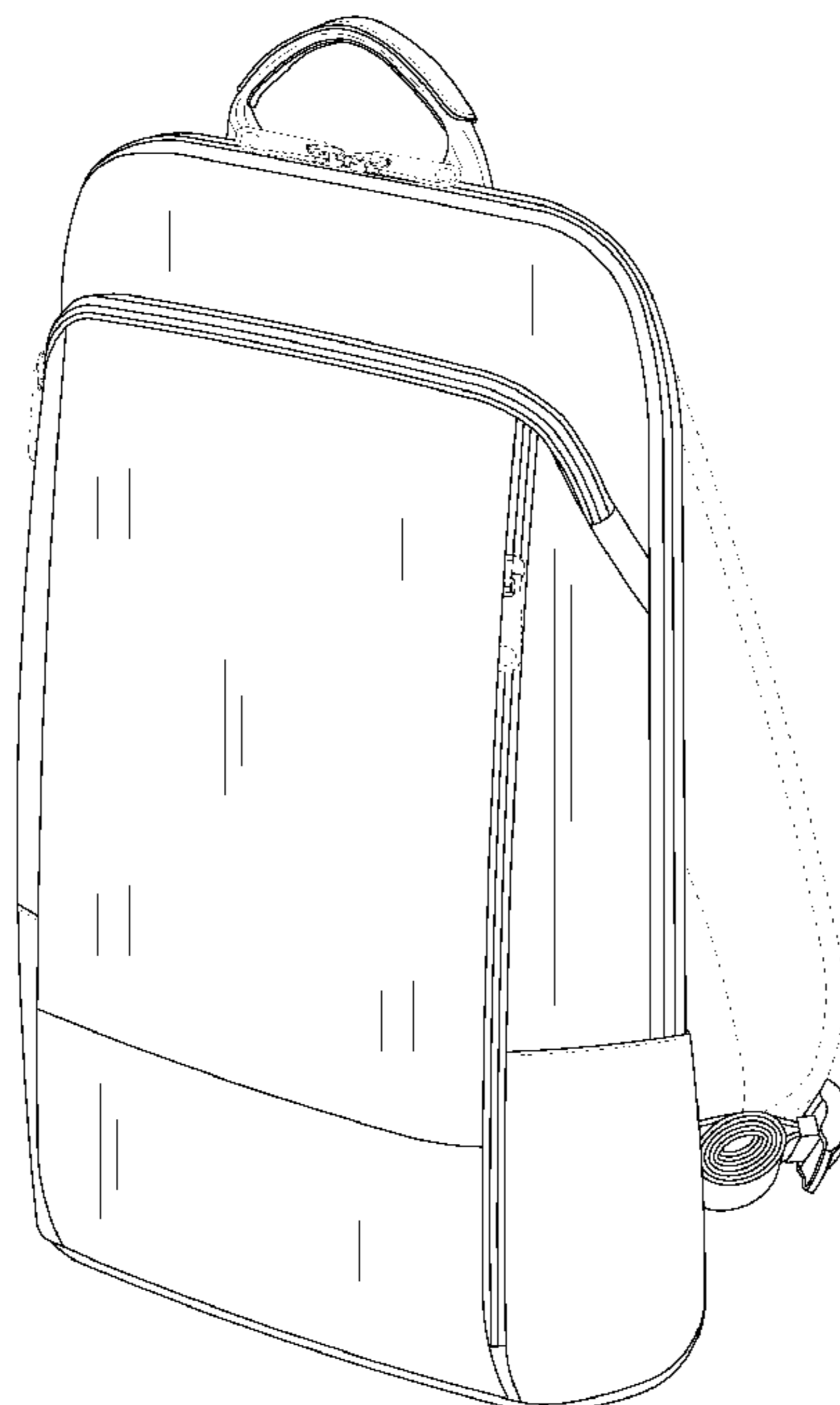

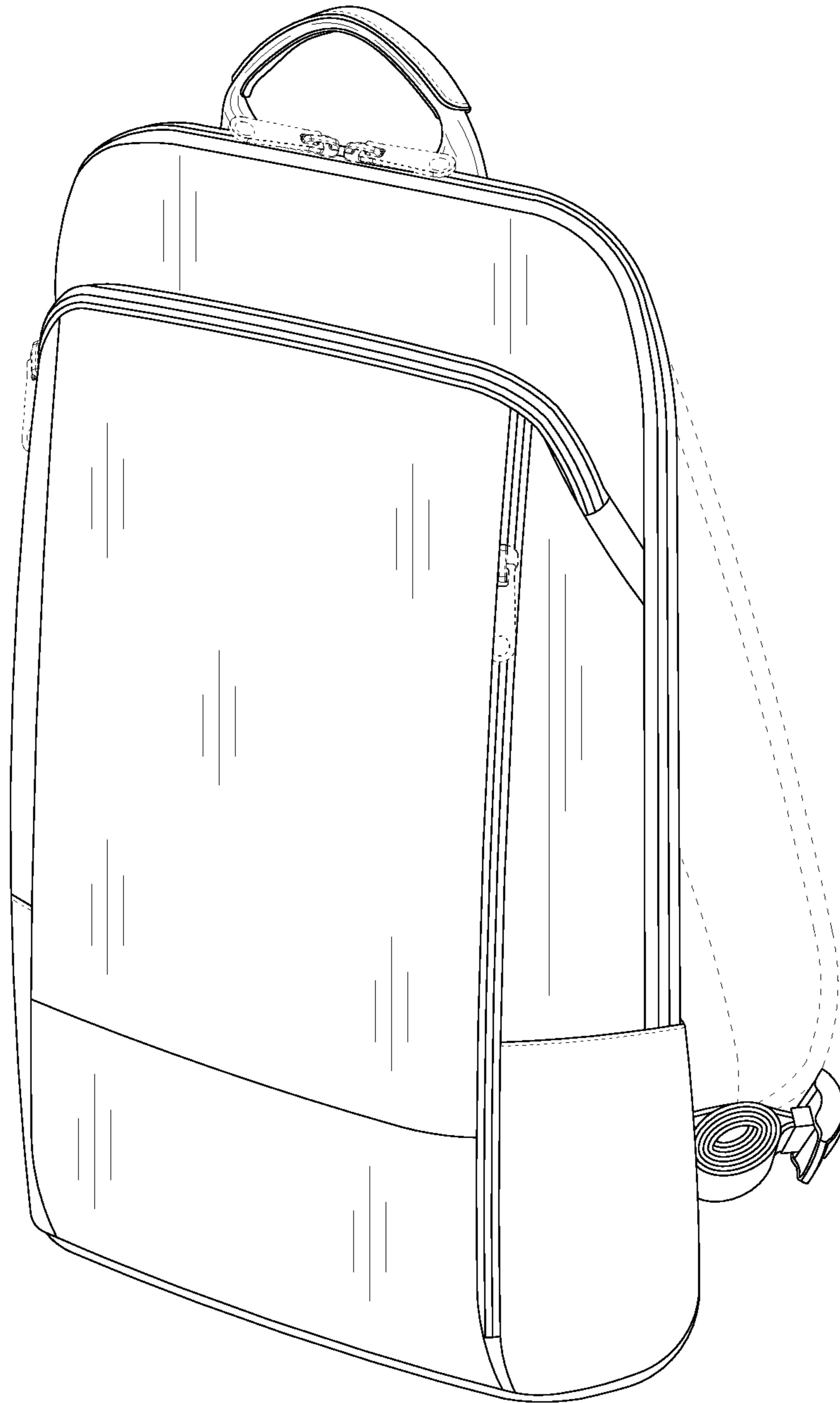

FIG. 1

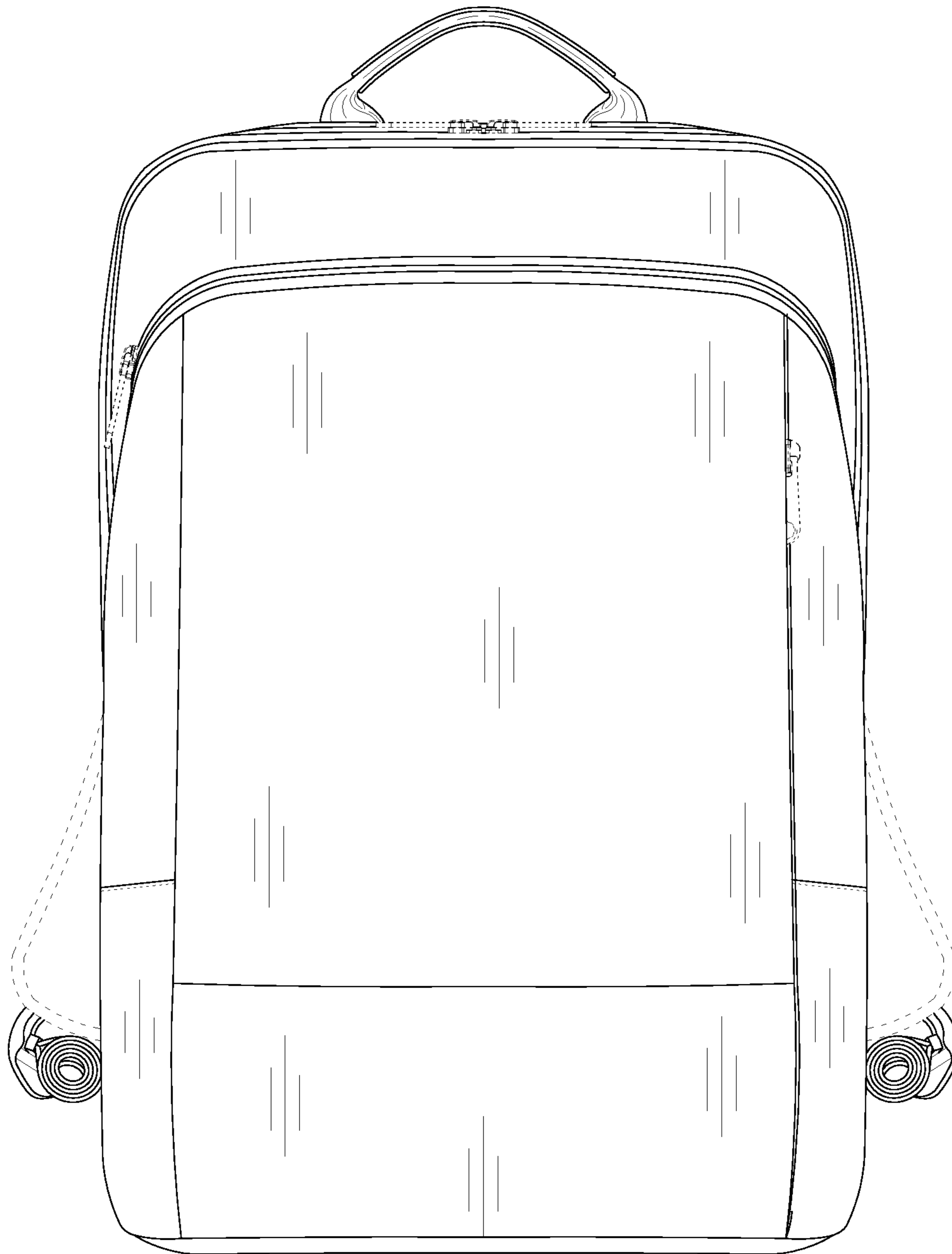

FIG. 2

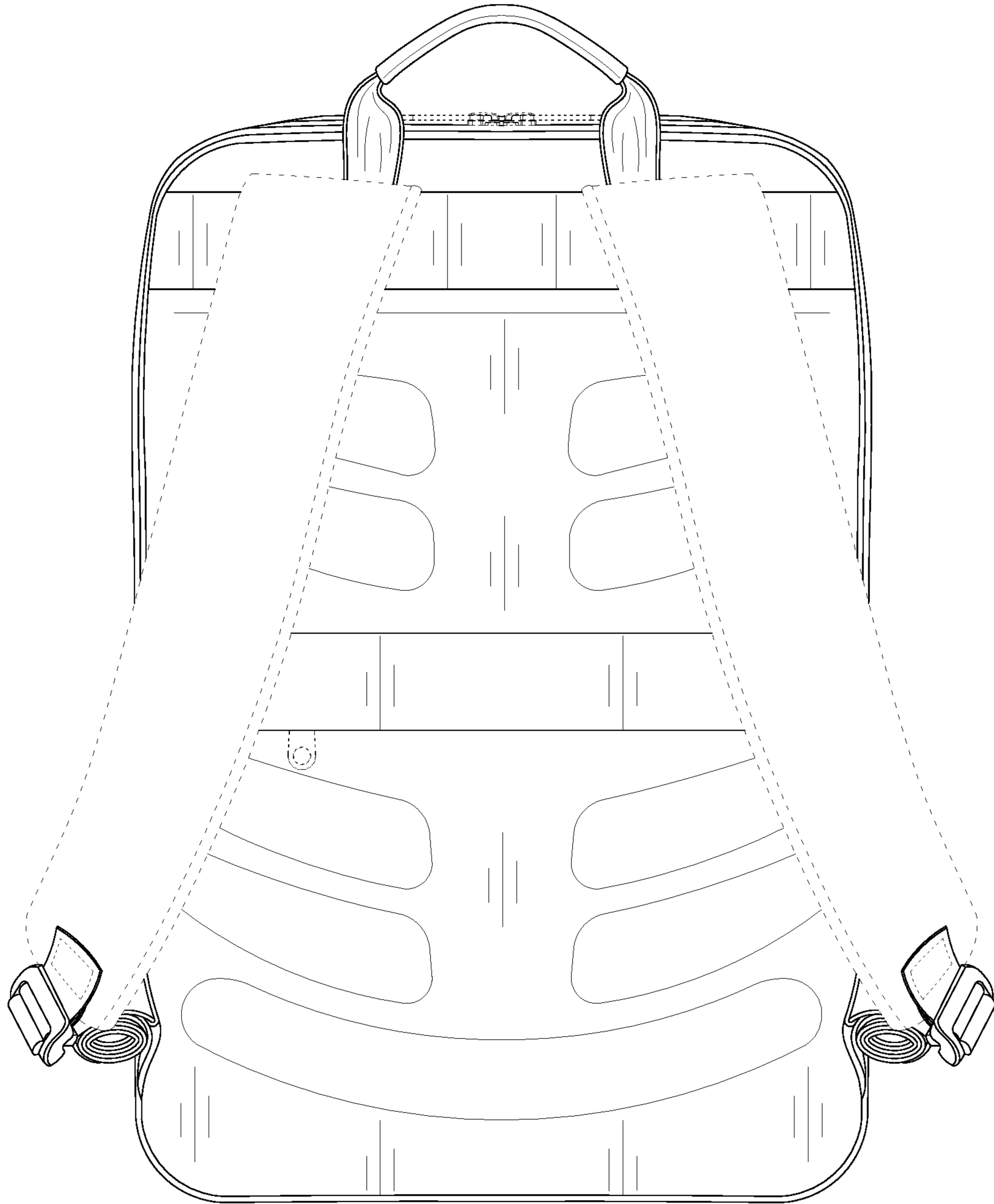

FIG. 3

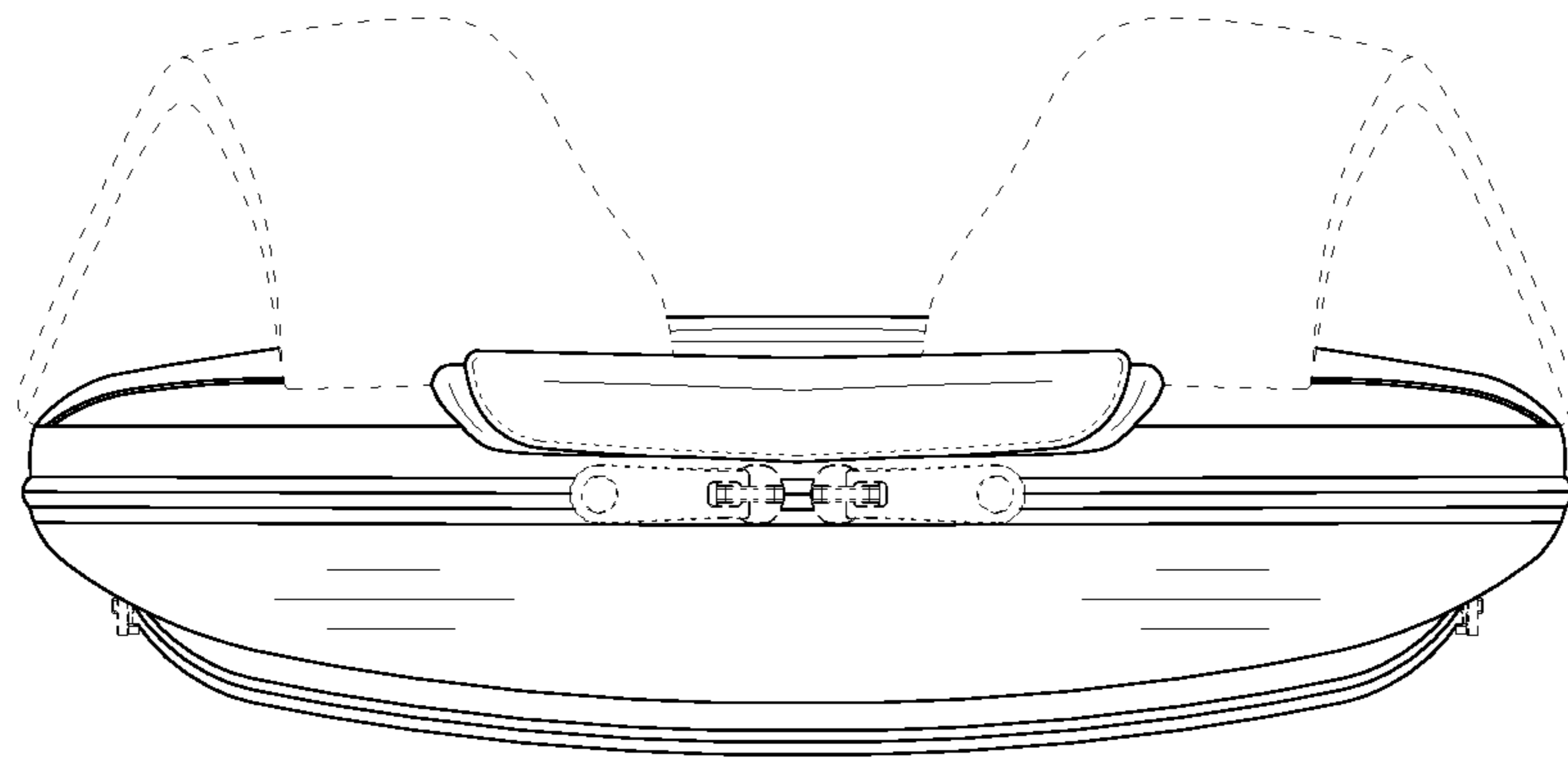

FIG. 4

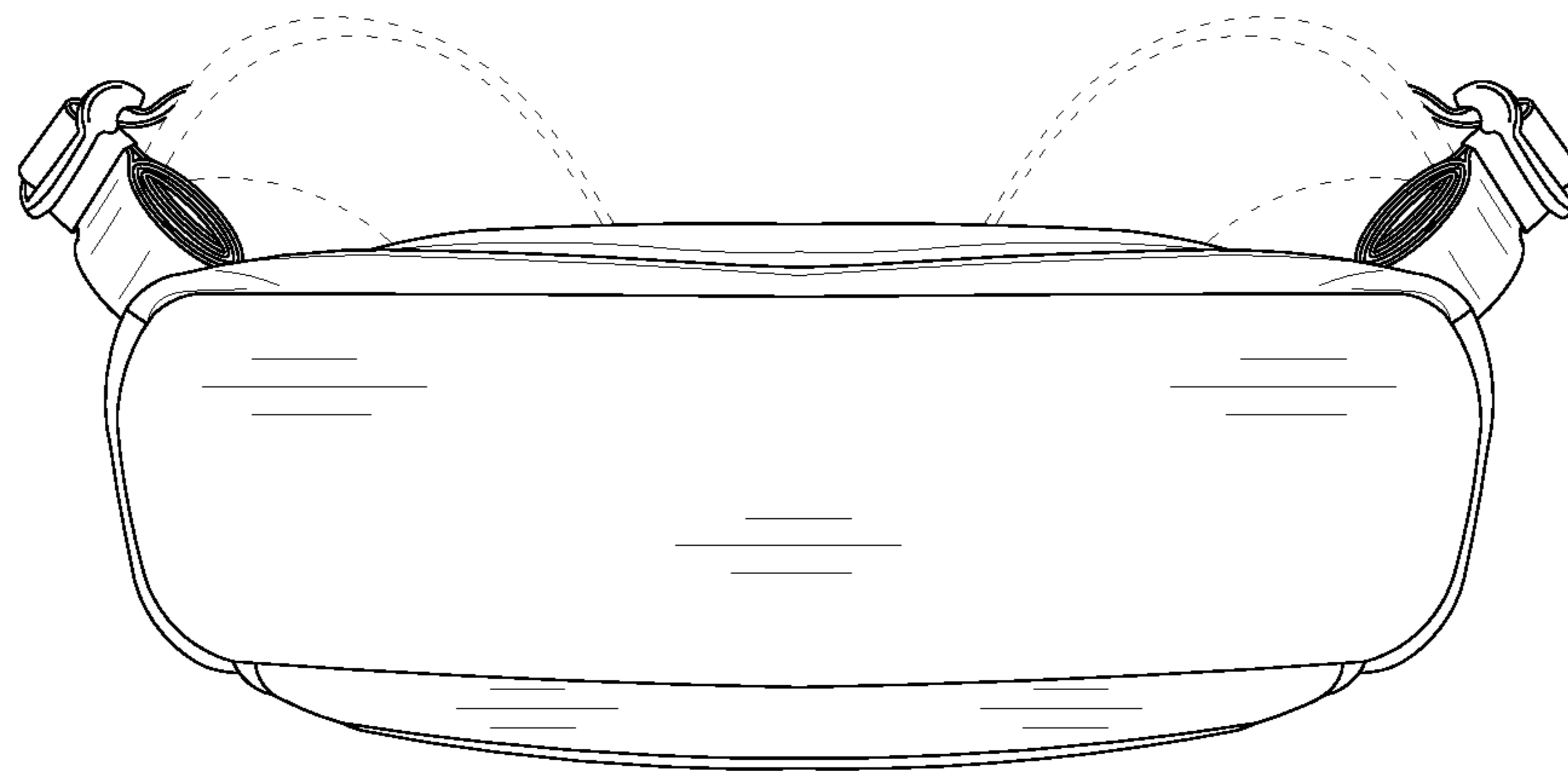

FIG. 5

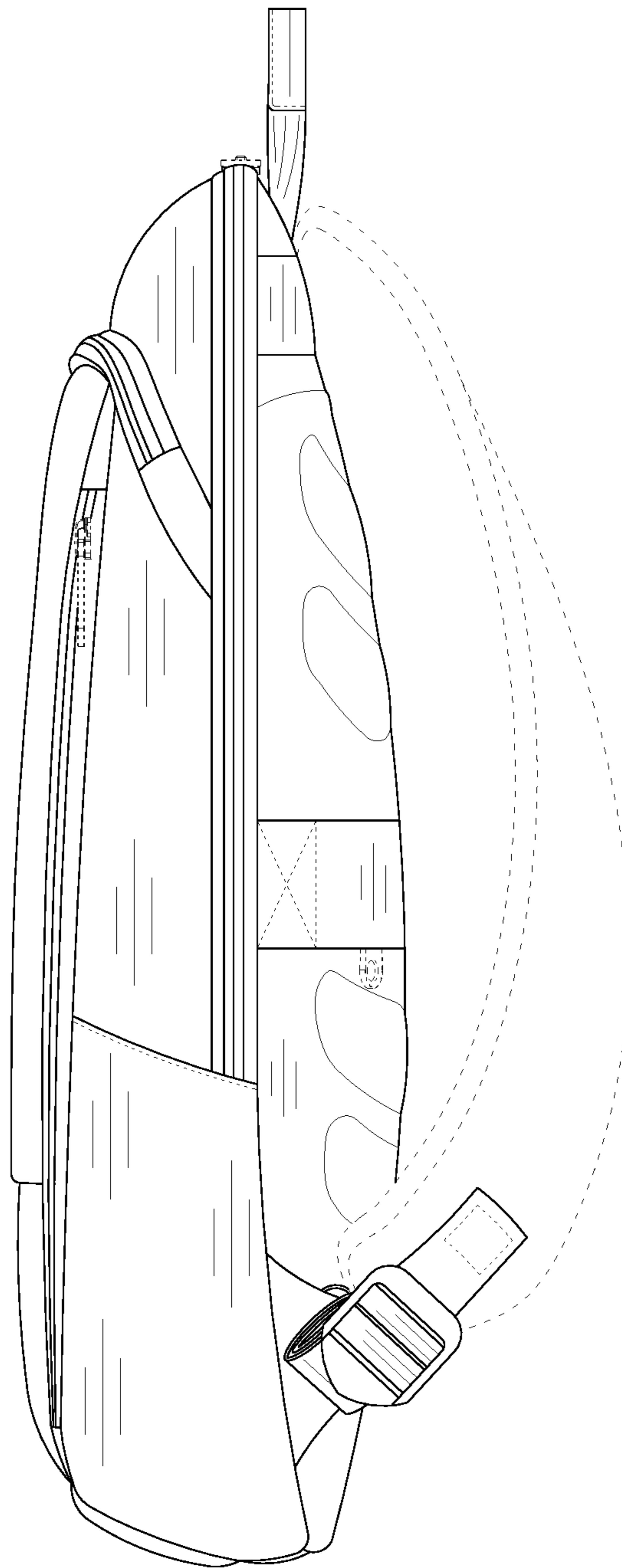

FIG. 6

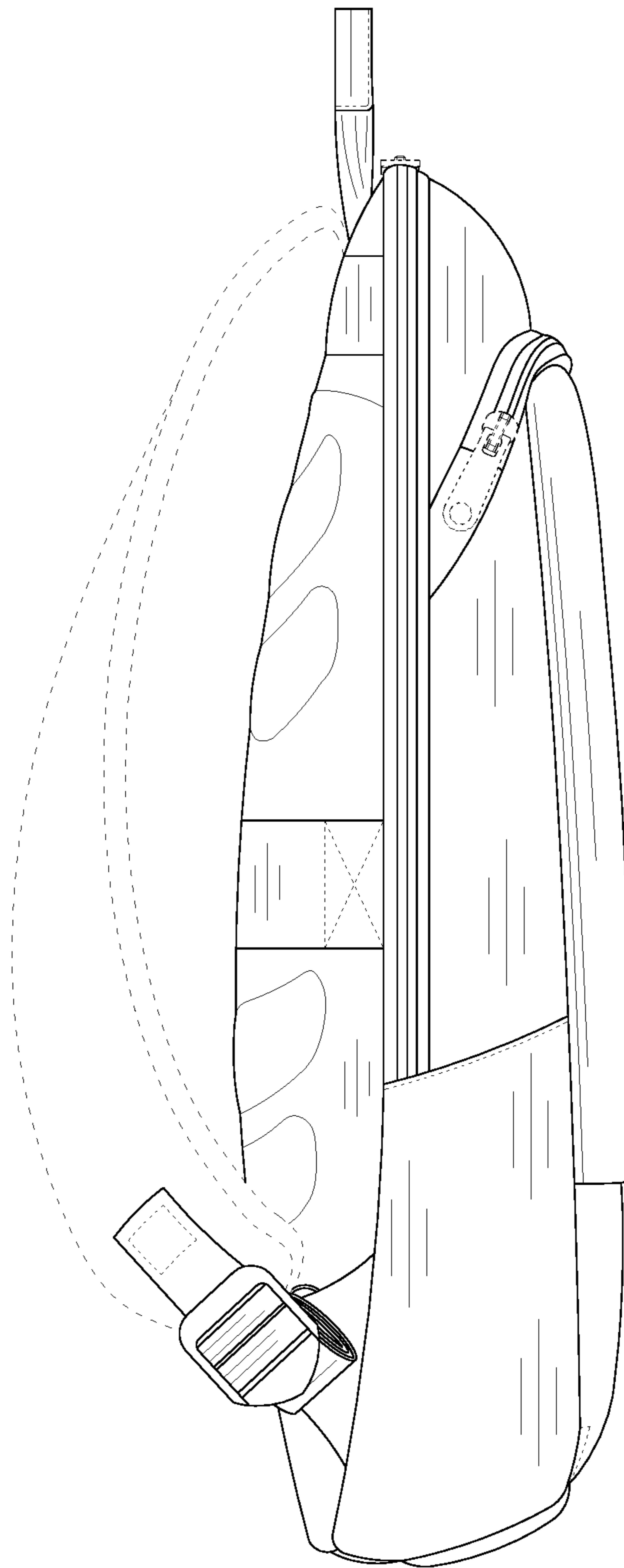

FIG. 7