



US00D946263S

(12) **United States Design Patent** (10) **Patent No.:** **US D946,263 S**
Albay et al. (45) **Date of Patent:** **** Mar. 22, 2022**

(54) **TRAVEL CASE FOR ELECTRIC TOOTHBRUSH**
(71) Applicant: **Braun GmbH**, Kronberg (DE)
(72) Inventors: **Devran Albay**, Frankfurt (DE); **Moritz Carlo Honisch**, Frankfurt (DE); **Fritz Schubert**, Bad Camberg (DE)
(73) Assignee: **Braun GmbH**, Kronberg (DE)
(**) Term: **15 Years**
(21) Appl. No.: **29/731,658**
(22) Filed: **Apr. 16, 2020**
(51) **LOC (13) Cl.** **03-01**
(52) **U.S. Cl.**
USPC **D3/205**
(58) **Field of Classification Search**
USPC ... D3/203.1–203.8, 205–206, 215, 219, 226, D3/247, 250–252, 263–266, 273, D3/293–294, 298–299, 301, 303, 315, D3/901; D6/515, 517, 534, 536; D7/600.1, 600.4, 637; D9/734, 759–760; D19/101–103, 106, 194–195; D27/172, D27/180, 183, 186, 189–191; D28/73, D28/76, 85–86, 91
CPC .. A24F 9/16; A24F 13/14; A24F 15/00; A24F 15/12; A24F 15/14; A24F 15/18; A24F 15/20; A24F 23/00; A24F 23/04; A24F 47/002; A24F 47/008; A45C 3/00; A45C 5/00; A45C 5/005; A45C 5/04; A45C 7/00; A45C 9/00; A45C 11/00; A45C 11/008; A45C 11/04; A45C 11/16; A45C 11/24; A45C 11/26; A45C 11/34; A45C 11/36; A45C 13/002; A45C 2011/007; A45D 33/12; A45D 33/14; A45D 33/22; A45D 33/24; A45D 33/26; A45D 33/28; A45D 34/00; A45D 34/04; A45D 34/041; A45D 34/06; A45D 40/00; A45D 40/18; A45D 40/26; A45D 40/261; A45D 40/262;

(Continued)

(56) **References Cited**
U.S. PATENT DOCUMENTS
D481,532 S * 11/2003 Sayers D3/203.1
D499,653 S * 12/2004 Karim D19/901
(Continued)

FOREIGN PATENT DOCUMENTS
CN 30492453 * 4/2017
CN 304237918 * 8/2017
(Continued)

OTHER PUBLICATIONS
CM 2Pcs Plastic Travel Case, unknown first available date, amazon.com [online] [site visited Apr. 23, 2021], Available at internet URL: https://www.amazon.com/CM-Electric-Toothbrush-Container-Compatible/dp/B083J31WJV/ref=sr_1_13?dchild=1&keywords=oral%2Bb%2Btravel%2Bcase&qid=1619196608&sr=8-13&th=1 (Year: 2021).*

(Continued)

Primary Examiner — Jeffrey D Asch
Assistant Examiner — Caitlin A Laverty
(74) *Attorney, Agent, or Firm* — Vladimir Vitenberg

(57) **CLAIM**
The ornamental design for a travel case for electric toothbrush, as shown and described.

DESCRIPTION

FIG. 1 is a perspective view of a travel case for electric toothbrush in opened position;
FIG. 2 is a front view thereof;
FIG. 3 is a right side view thereof;
FIG. 4 is a rear view thereof;
FIG. 5 is a left side view thereof;
FIG. 6 is a top plan view thereof; and,
FIG. 7 is a bottom view thereof.

1 Claim, 3 Drawing Sheets

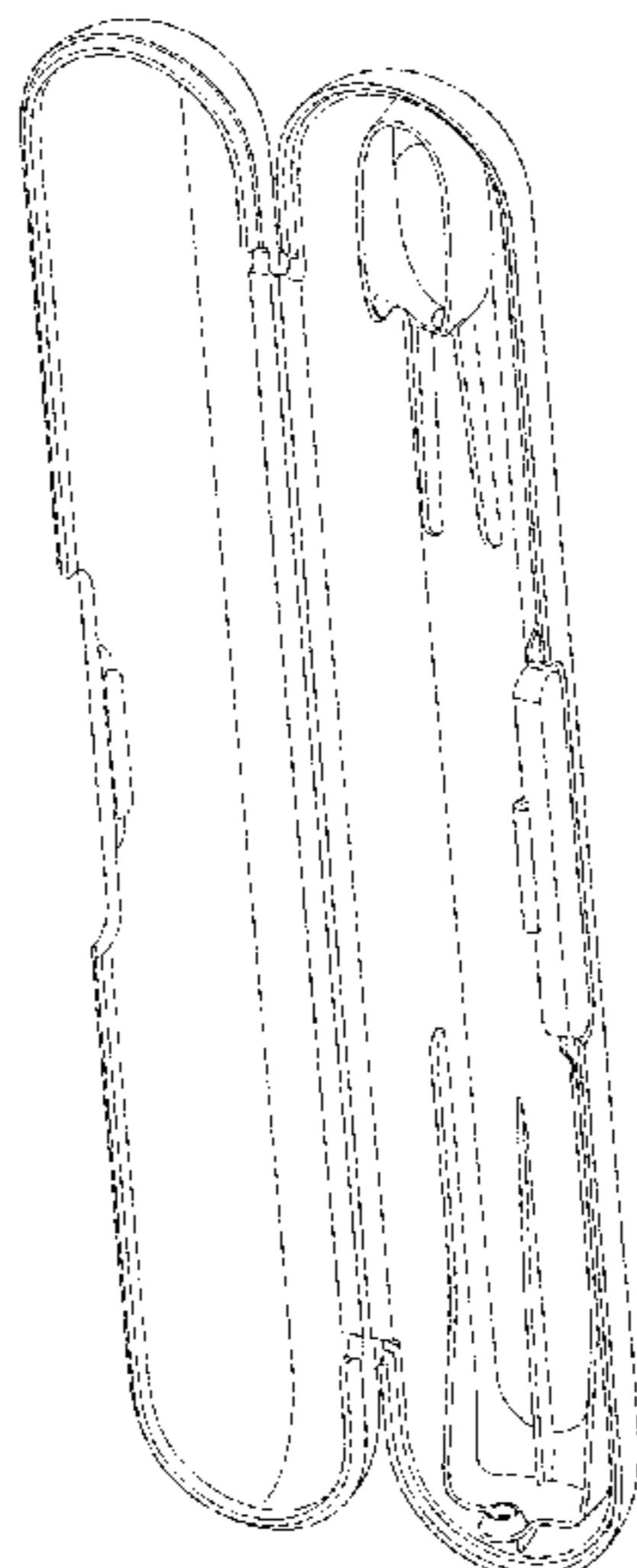

(58) **Field of Classification Search**

CPC . A45D 44/11; A45D 44/18; A47F 7/02; A47F 7/021; A61J 1/00; A61J 1/03; A61J 7/04; A61J 7/0084; B65D 1/36; B65D 43/16; B65D 50/04; B65D 83/04; B65D 83/0445; B65D 83/0481; B65D 85/00; B65D 85/02; B65D 85/10

See application file for complete search history.

D897,831 S * 10/2020 Hawry D9/414
 D901,167 S * 11/2020 Li D3/205
 D909,746 S * 2/2021 Albay D3/205
 D927,180 S * 8/2021 Lopez D3/265
 2011/0303569 A1* 12/2011 Johnson A45D 44/18
 206/361
 2016/0317268 A1* 11/2016 Dietzel A46B 17/065

(56)

References Cited

U.S. PATENT DOCUMENTS

D665,571 S * 8/2012 Tello B42D 25/22
 D3/203.2
 D682,538 S * 5/2013 Rollo D3/205
 D731,178 S * 6/2015 Gorouvein D3/265
 D731,784 S * 6/2015 McGarry D3/205
 D786,563 S * 5/2017 Triato D4/104
 D838,480 S * 1/2019 Son D3/294
 D866,164 S * 11/2019 Chen D3/205
 D873,217 S * 1/2020 Zhang D13/108
 D887,127 S * 6/2020 Kauffman D3/201
 D895,960 S * 9/2020 Goeder D3/205

FOREIGN PATENT DOCUMENTS

CN 304263200 * 9/2017
 CN 304645006 * 5/2018
 CN 304686356 * 6/2018
 JP D1395735 * 8/2010

OTHER PUBLICATIONS

Nincha Portable Replacement Plastic Electric Toothbrush Travel Case, first available May 8, 2019 based on customer photo review, amazon.com [online], [site visited Apr. 23, 2021], Available at internet URL: <https://www.amazon.com/Nincha-Portable-Replacement-Toothbrush-Transparent/dp/B06XJKZ759?th=1> (Year: 2019).*

* cited by examiner

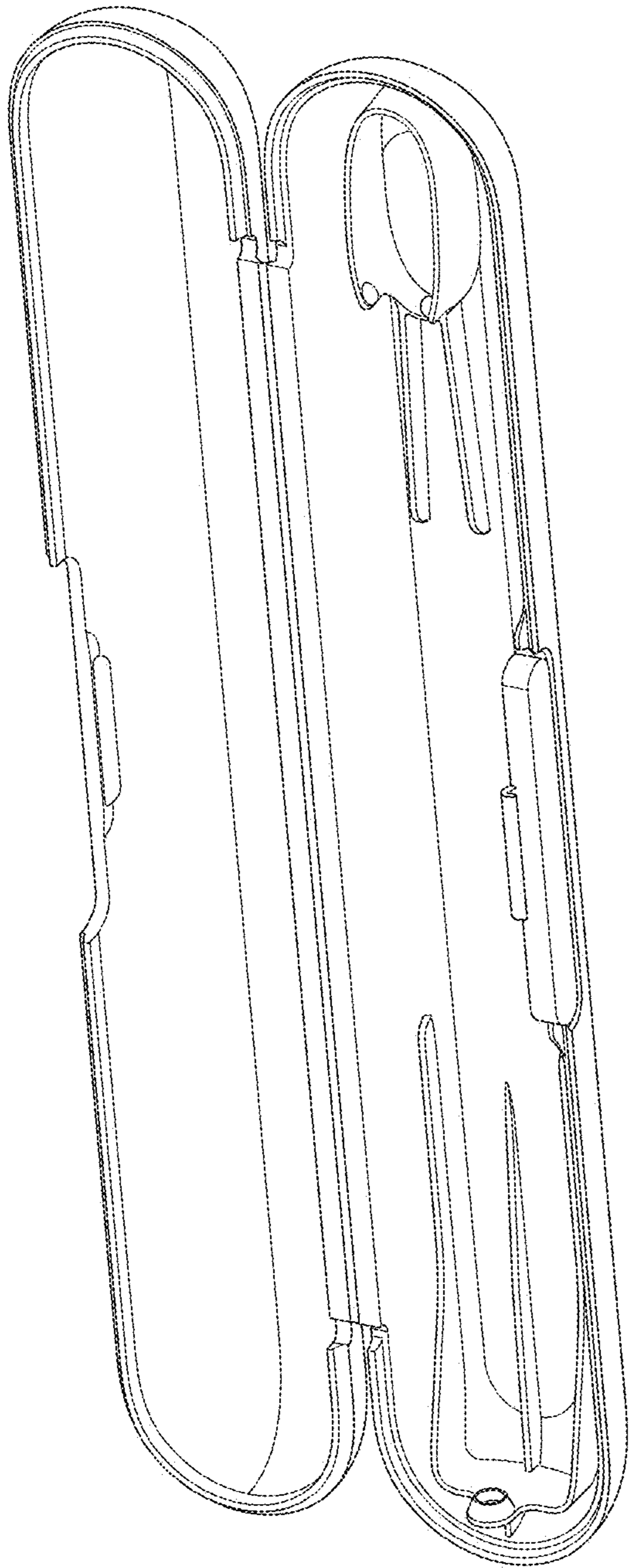

FIG. 1

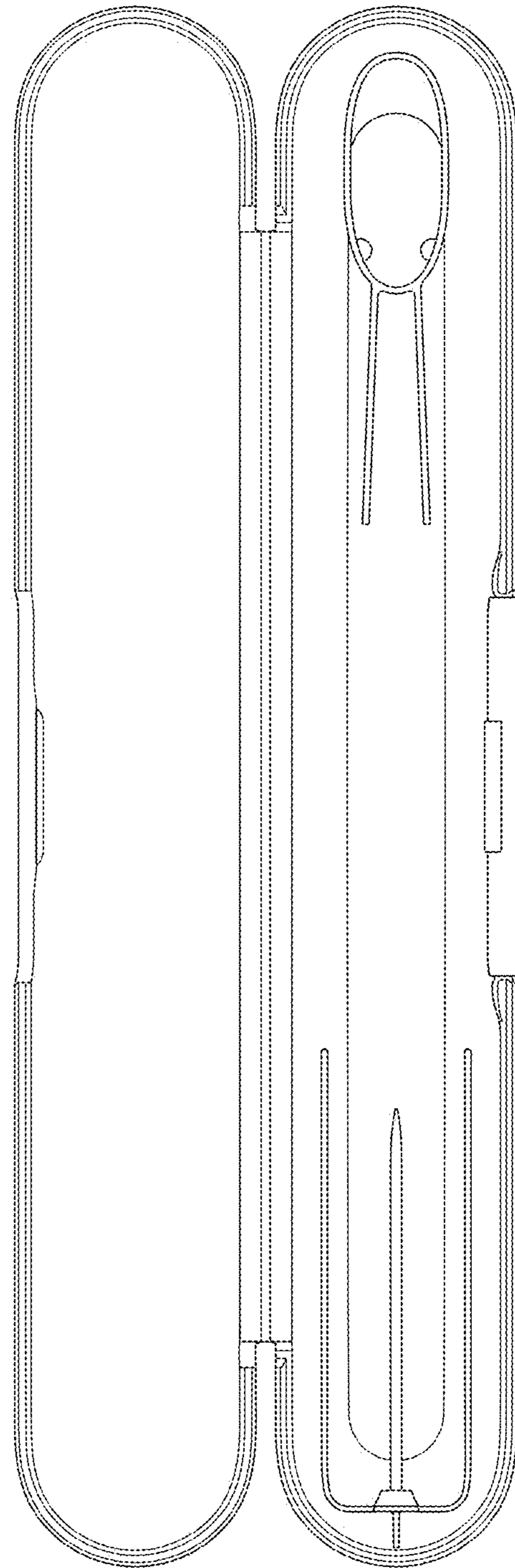

FIG. 2

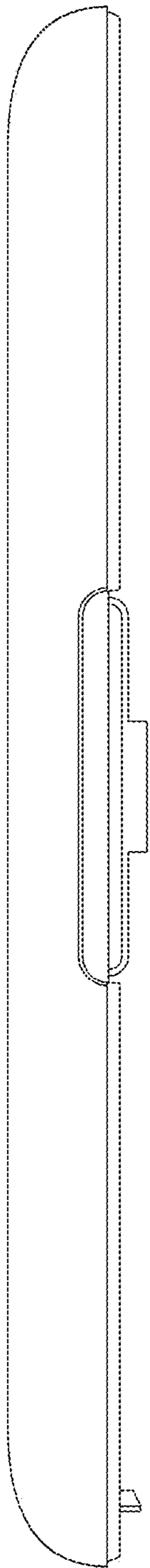

FIG. 3

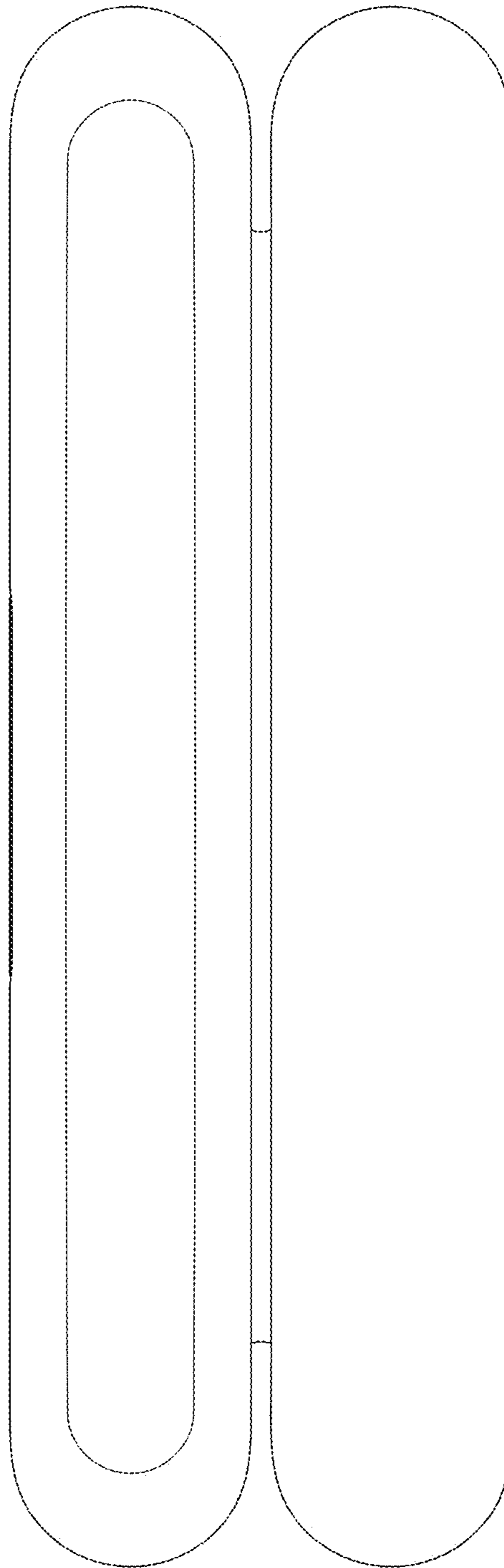

FIG. 4

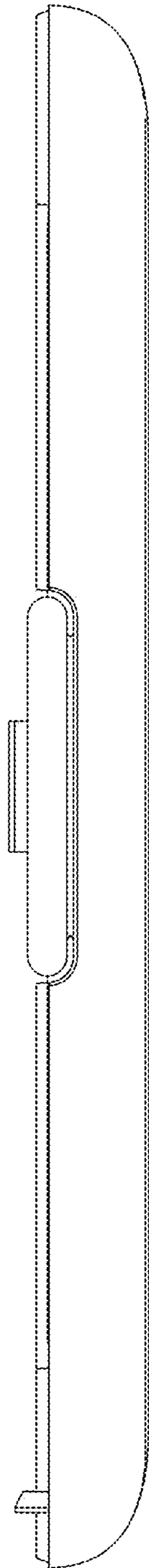

FIG. 5

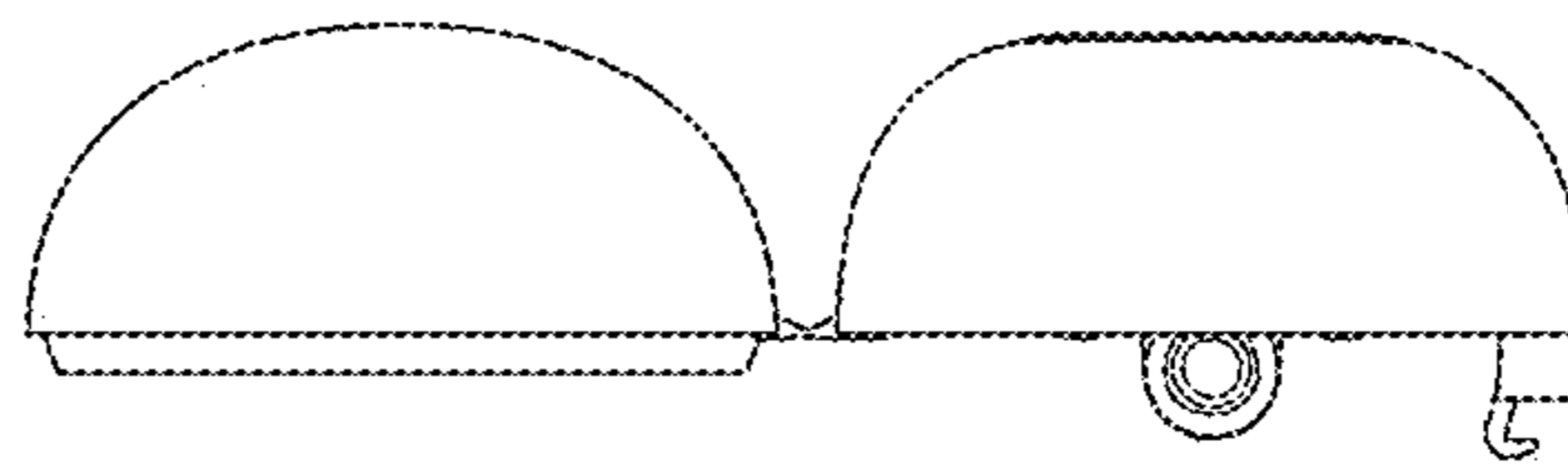

FIG. 6

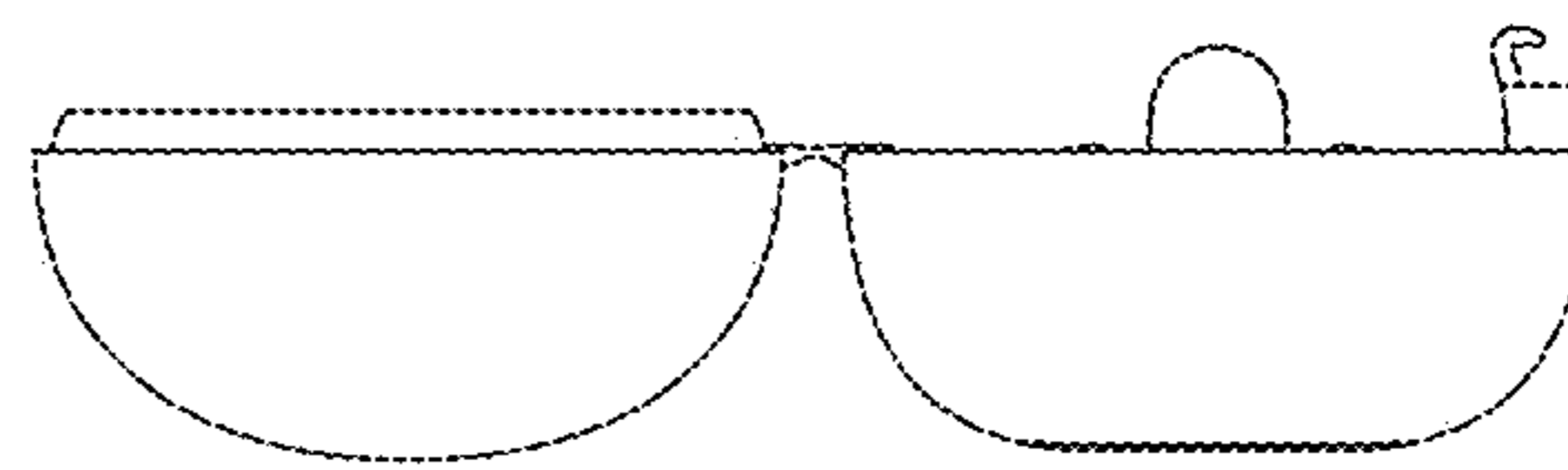

FIG. 7