



US00D946252S

(12) **United States Design Patent** (10) **Patent No.:** **US D946,252 S**  
**Klemetsrud** (45) **Date of Patent:** **\*\* Mar. 22, 2022**

(54) **SHOE**

(71) Applicant: **PUMA SE**, Herzogenaurach (DE)

(72) Inventor: **Kyle Klemetsrud**, Somerville, MA (US)

(73) Assignee: **PUMA SE**, Herzogenaurach (DE)

(\*\*) Term: **15 Years**

(21) Appl. No.: **29/770,379**

(22) Filed: **Feb. 11, 2021**

**Related U.S. Application Data**

(63) Continuation of application No. 29/708,769, filed on Oct. 9, 2019, now Pat. No. Des. 913,661.

(51) **LOC (13) Cl.** ..... **02-04**

(52) **U.S. Cl.**  
USPC ..... **D2/947**; D2/960

(58) **Field of Classification Search**  
USPC ..... D2/902, 906, 908, 916, 918, 925, D2/946-962, 977; 36/1, 1.5, 3 B, 22 R, 36/24.5, 25 R, 28, 32 R, 34 R, 59 C, 36/67 A, 101-107, 114-116, 117.3, 117.4, 36/124-136  
CPC ..... A43B 13/00; A43B 13/02; A43B 13/023; A43B 13/026; A43B 13/04; A43B 13/08; A43B 13/10; A43B 13/12; A43B 13/14; A43B 13/141; A43B 13/143; A43B 13/16; A43B 13/18; A43B 13/181; A43B 13/187; A43B 13/189; A43B 13/20; A43B 13/22; A43B 13/223; A43B 13/24; A43B 13/28; A43B 13/30; A43B 13/32; A43B 13/34; A43B 13/36

See application file for complete search history.

(56) **References Cited**

U.S. PATENT DOCUMENTS

D324,762 S	3/1992	Hatfield	
D330,110 S	10/1992	Worthington	
D330,972 S	11/1992	Hatfield et al.	
D331,831 S	12/1992	Byrne et al.	
D333,551 S	3/1993	Bailey	
D334,279 S	3/1993	Teague	
D334,650 S	4/1993	Teague	
D496,148 S *	9/2004	Kayano .....	D2/953
D543,686 S	6/2007	Andersen et al.	

(Continued)

OTHER PUBLICATIONS

Fusion Nitro Basketball Shoes, Puma.com, [online], [site visited Nov. 17, 2021]. <URL: [https://us.puma.com/us/en/pd/fusion-nitro-basketball-shoes/195514.html?dwvar\\_195514\\_color=01](https://us.puma.com/us/en/pd/fusion-nitro-basketball-shoes/195514.html?dwvar_195514_color=01)> (Year: 2021).\*

(Continued)

*Primary Examiner* — Jonathan J Han

(74) *Attorney, Agent, or Firm* — Quarles & Brady LLP

(57) **CLAIM**

The ornamental design for a shoe, as shown and described.

**DESCRIPTION**

FIG. 1 is a top, left, and front perspective view of an ornamental design for a shoe;  
FIG. 2 is a front elevational view of the shoe of FIG. 1;  
FIG. 3 is a rear elevational view of the shoe of FIG. 1;  
FIG. 4 is a left side elevational view of the shoe of FIG. 1;  
FIG. 5 is a right side elevational view of the shoe of FIG. 1;  
FIG. 6 is a top plan view of the shoe of FIG. 1;  
FIG. 7 is a bottom plan view of the shoe of FIG. 1; and,  
FIG. 8 is a bottom, left, and front perspective view of the shoe of FIG. 1.

The broken lines illustrate portions of the shoe that form no part of the claimed design.

**1 Claim, 7 Drawing Sheets**

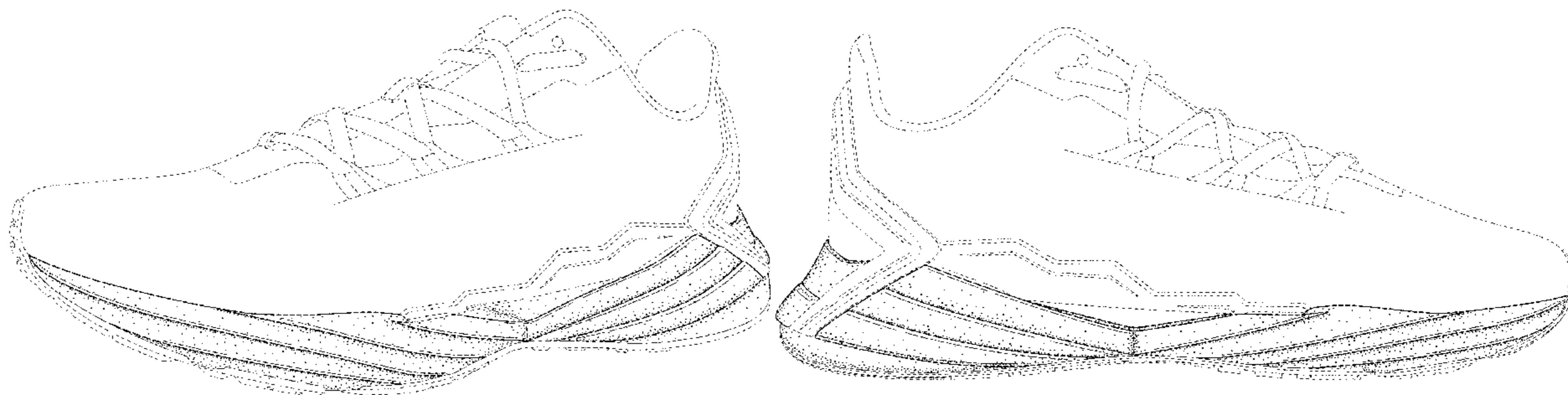

(56)

References Cited

U.S. PATENT DOCUMENTS

D714,035 S \* 9/2014 O'Connor ..... D2/947  
 D725,878 S \* 4/2015 Teng-Lee ..... D2/947  
 D741,584 S \* 10/2015 Christopherson ..... D2/947  
 D745,772 S 12/2015 Woodman  
 D765,365 S 9/2016 Chang  
 D784,667 S \* 4/2017 Wright ..... D2/947  
 D788,415 S 6/2017 Caron et al.  
 D790,174 S 6/2017 Pulli  
 D799,189 S 10/2017 Odinot  
 D807,632 S 1/2018 Sullivan  
 D812,362 S 3/2018 Gibson  
 D820,567 S \* 6/2018 Pulli ..... D2/947  
 D821,714 S \* 7/2018 Chang ..... D2/947  
 D822,964 S 7/2018 Hui  
 D828,985 S 9/2018 Gibson  
 D831,311 S \* 10/2018 Pulli ..... D2/902  
 D834,291 S \* 11/2018 Chang ..... D2/947  
 10,188,174 B2 \* 1/2019 Dojan ..... A43B 7/144  
 D841,950 S 3/2019 Ikeda et al.  
 D848,127 S 5/2019 Nethongkome  
 D853,099 S 7/2019 Parrett  
 D858,054 S 9/2019 McMillan  
 D875,371 S 2/2020 Seamarks  
 D876,761 S \* 3/2020 Zhu ..... D2/947  
 D877,467 S 3/2020 Taylor  
 D882,223 S 4/2020 Chipman  
 D882,914 S 5/2020 Devito  
 D885,721 S 6/2020 Williams  
 D885,725 S \* 6/2020 de Montgolfier ..... D2/947  
 D889,790 S \* 7/2020 O'Connor ..... D2/947  
 D894,576 S 9/2020 Devito

D896,485 S 9/2020 Williams  
 D897,646 S 10/2020 Rasmussen  
 D903,252 S 12/2020 Vella  
 D903,253 S 12/2020 Vella  
 D910,985 S \* 2/2021 Head ..... D2/947  
 D913,661 S \* 3/2021 Klemetsrud ..... D2/947  
 D917,138 S \* 4/2021 Head ..... D2/947  
 2014/0259782 A1 \* 9/2014 Dojan ..... A43B 7/144  
 36/102  
 2014/0259788 A1 \* 9/2014 Dojan ..... A43B 1/0018  
 36/103  
 2014/0259789 A1 \* 9/2014 Dojan ..... A43B 13/181  
 36/103  
 2020/0113273 A1 \* 4/2020 Aubonnet ..... A43B 13/146

OTHER PUBLICATIONS

Puma UltraRide Performance Review, WearTesters.com, Drew Whitcomb, Aug. 14, 2020, [online], [site visited Nov. 17, 2021]. <URL: <https://weartesters.com/puma-ultraride-performance-review/>> (Year: 2020).  
 RS-2K NYC Men's Sneakers, Puma.com, [online], [site visited Jan. 28, 2021]. <URL: [https://us.puma.com/en/us/pd/rs-2k-nyc-mens-sneakers/375544.html?dwvar\\_375544\\_color=01](https://us.puma.com/en/us/pd/rs-2k-nyc-mens-sneakers/375544.html?dwvar_375544_color=01)> (Year: 2021).  
 UltraRide Runner ID Men's Running Shoes, Puma.com, [online], [site visited Jan. 28, 2021]. <URL: [https://us.puma.com/en/us/pd/ultraride-runner-id-mens-running-shoes/193755.html?dwvar\\_193755\\_color=02](https://us.puma.com/en/us/pd/ultraride-runner-id-mens-running-shoes/193755.html?dwvar_193755_color=02)> (Year: 2021).  
 Review: Puma Ultraride, RunningMagazine.ca, Madeleine Kelly, Sep. 21, 2020, [online], [site visited Jan. 28, 2021]. <URL: <https://runningmagazine.ca/sections/gear/review-puma-ultraride/>> (Year: 2020).

\* cited by examiner

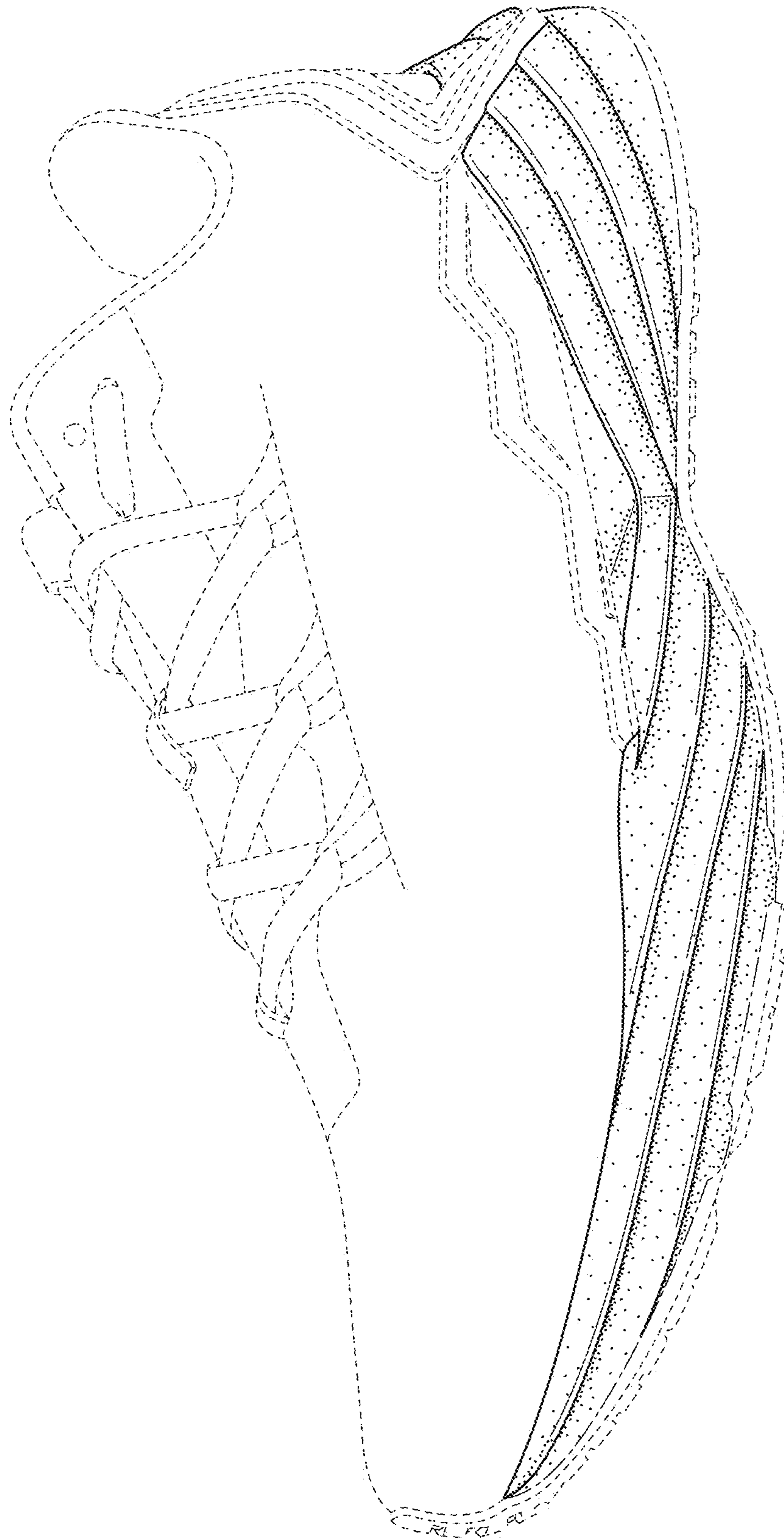

FIG. 1

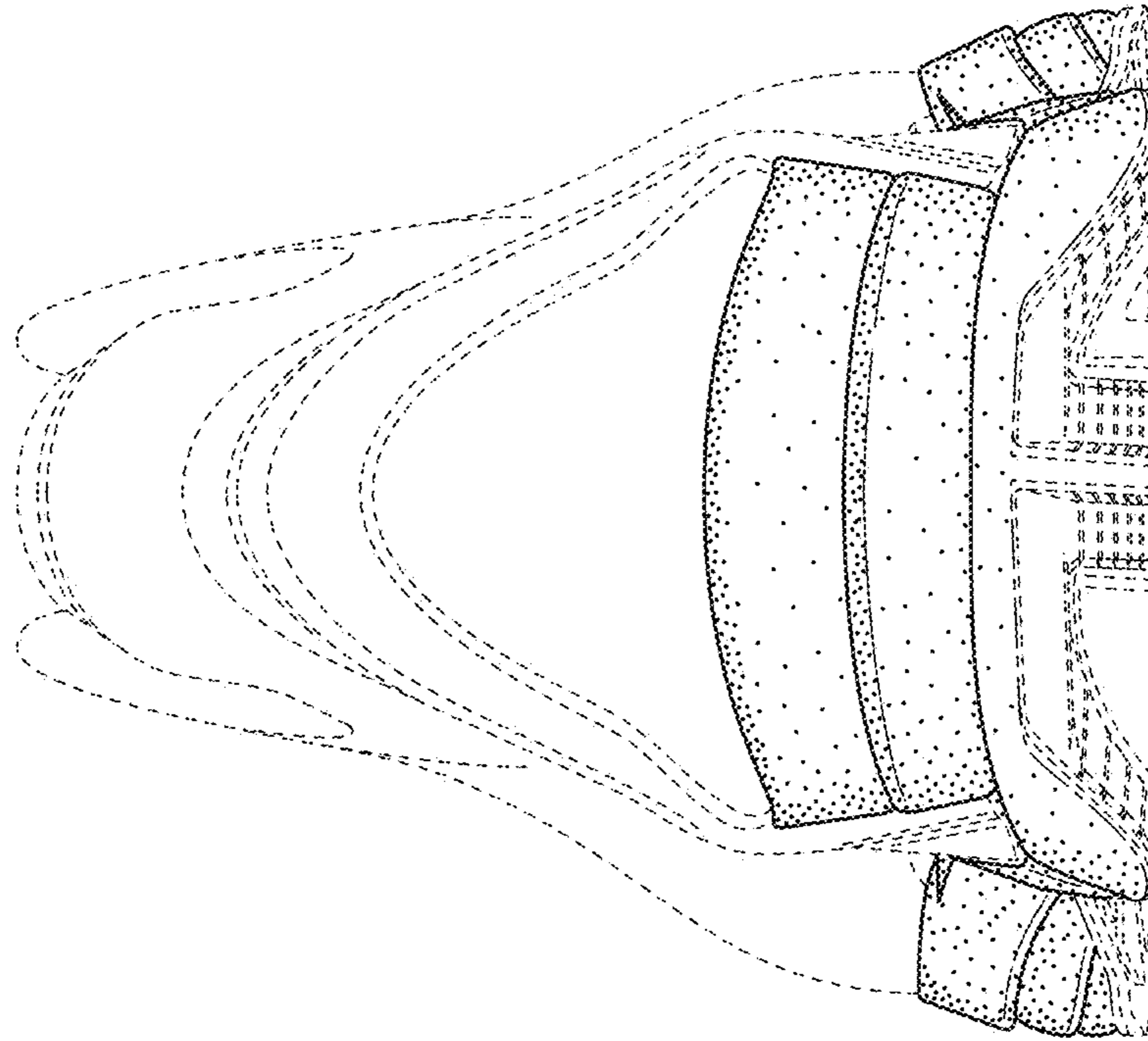

FIG. 3

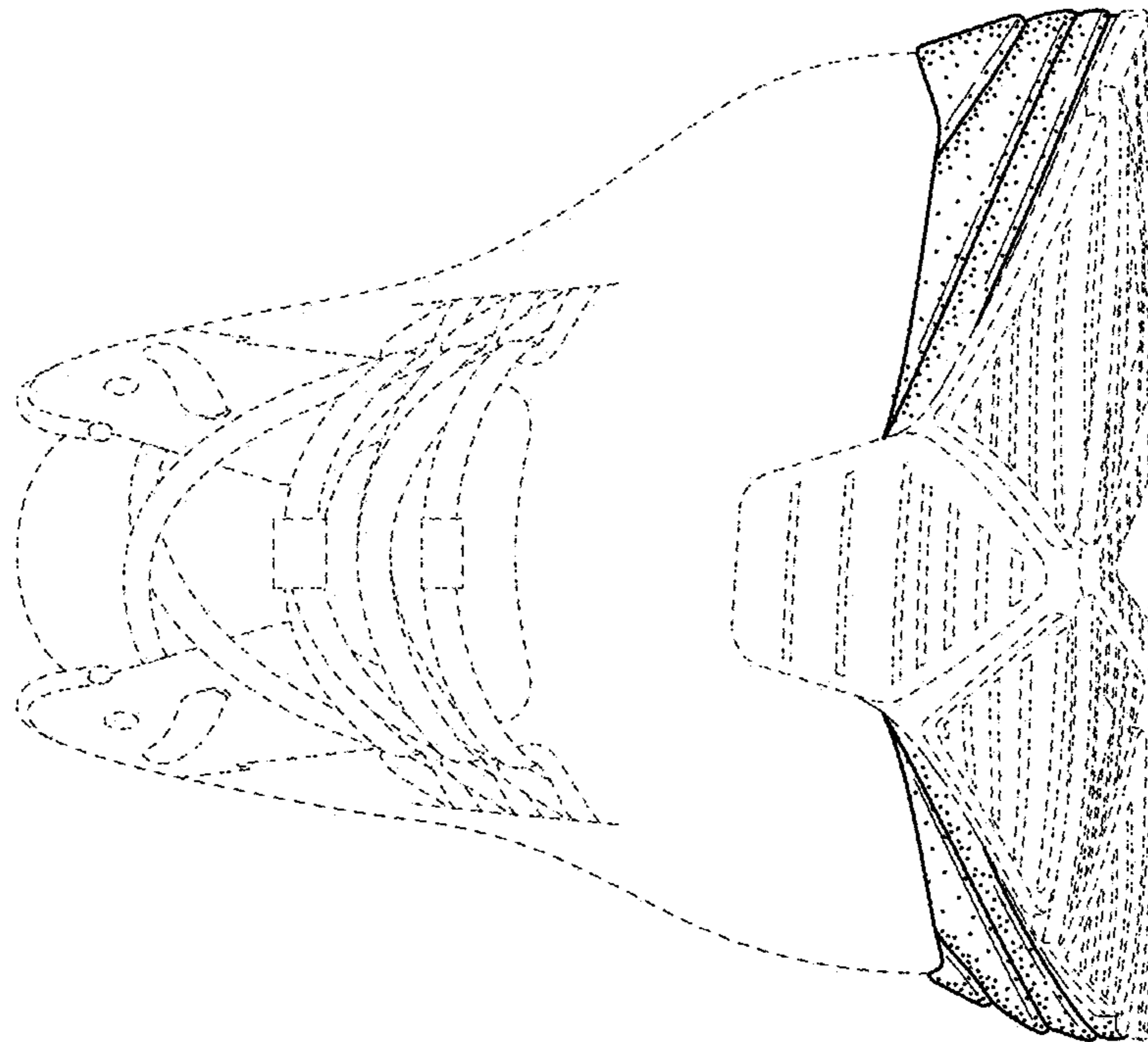

FIG. 2

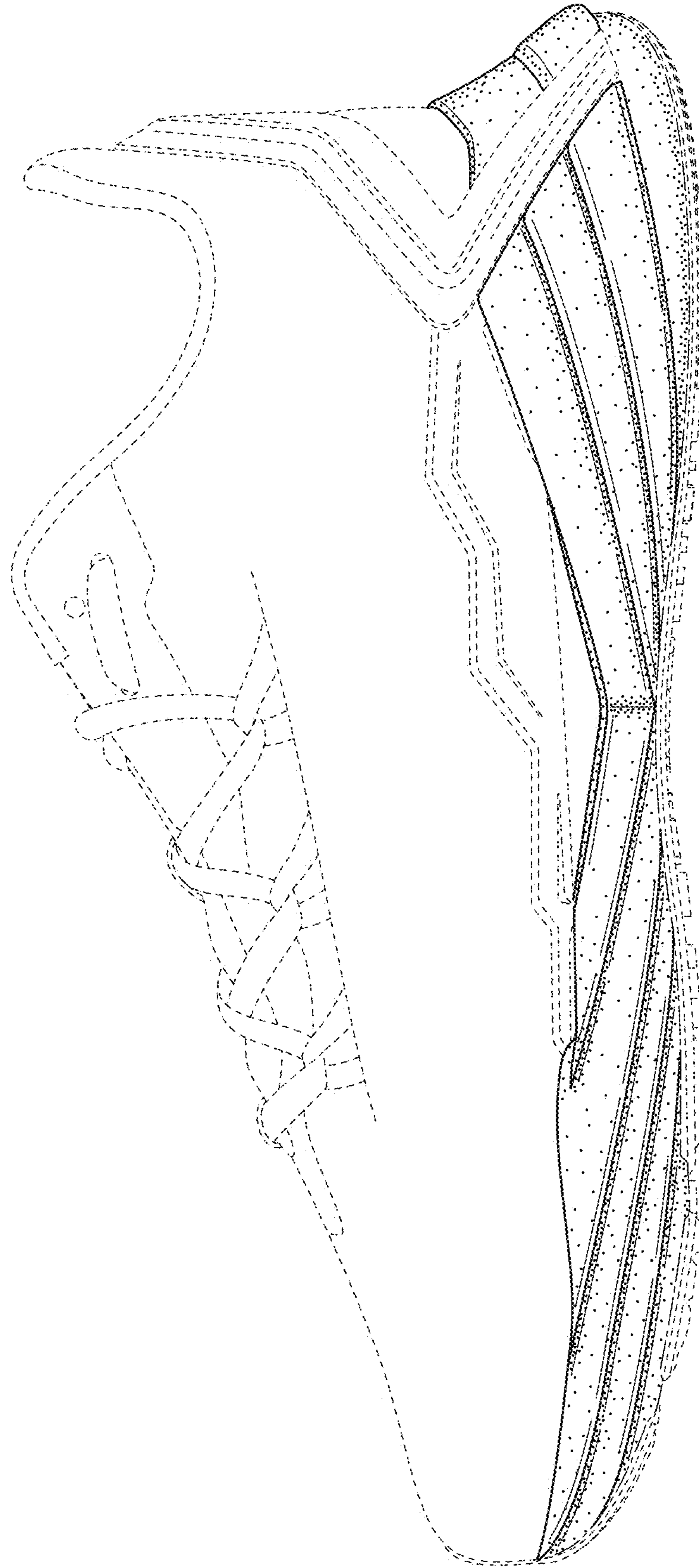

FIG. 4

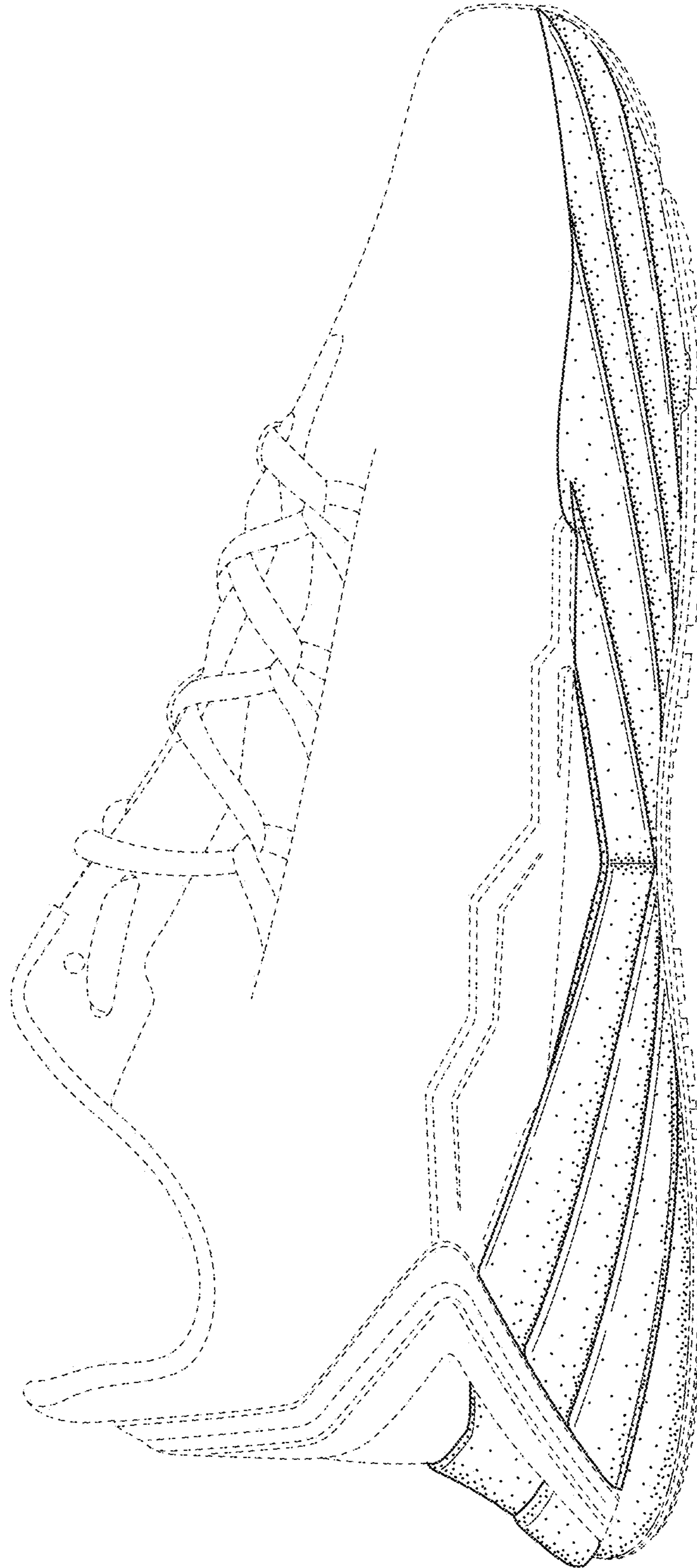

FIG. 5

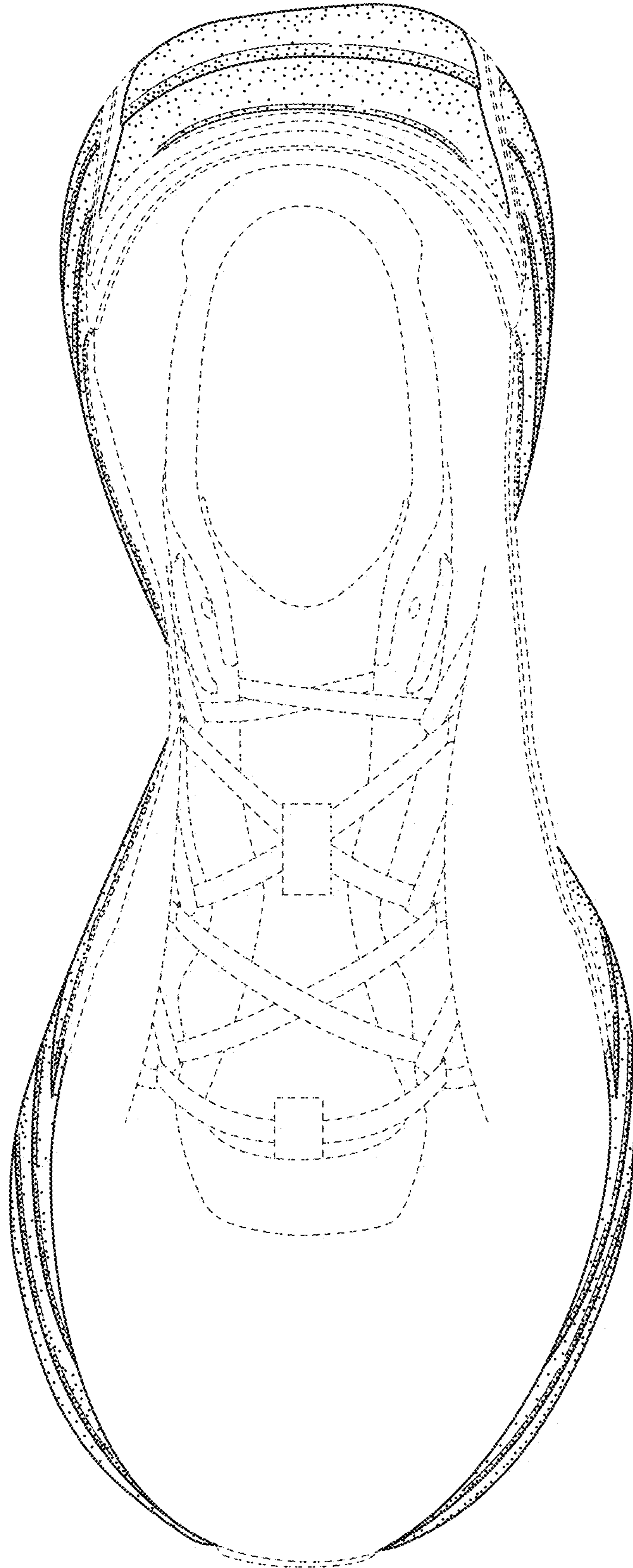

FIG. 6

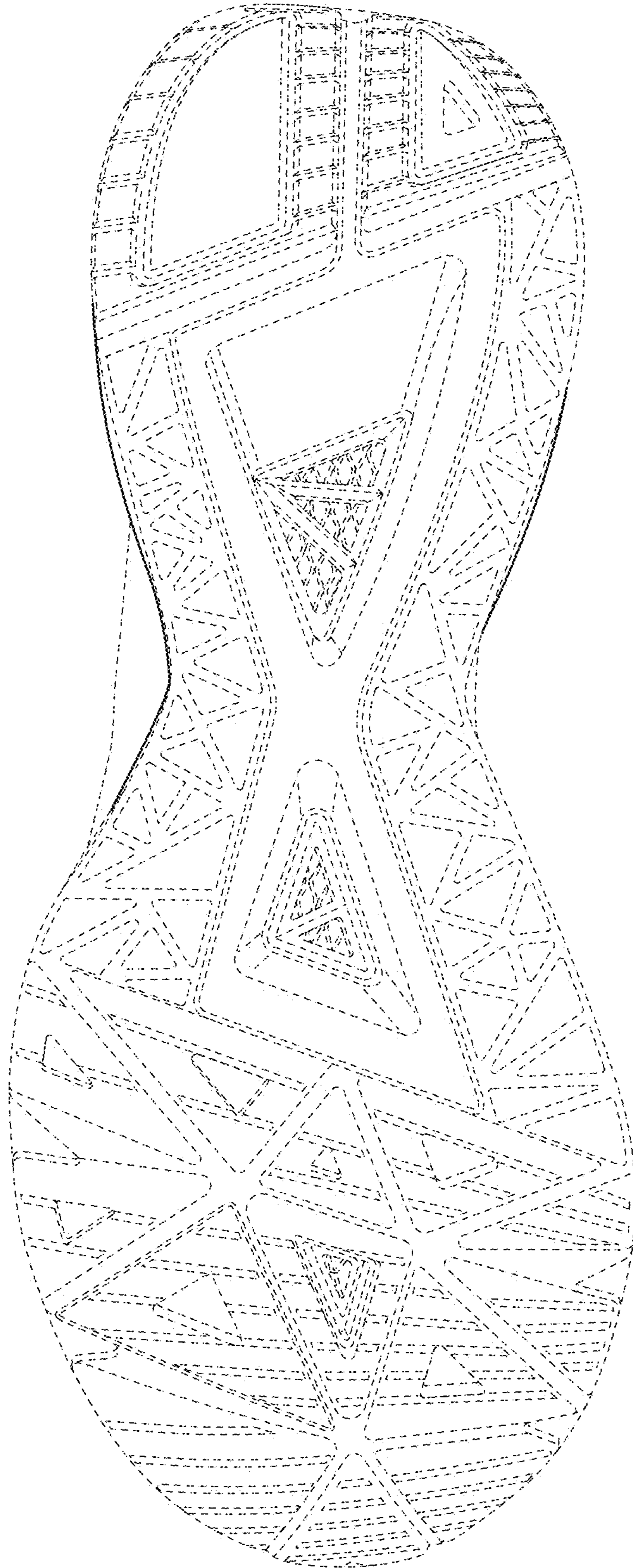

FIG. 7



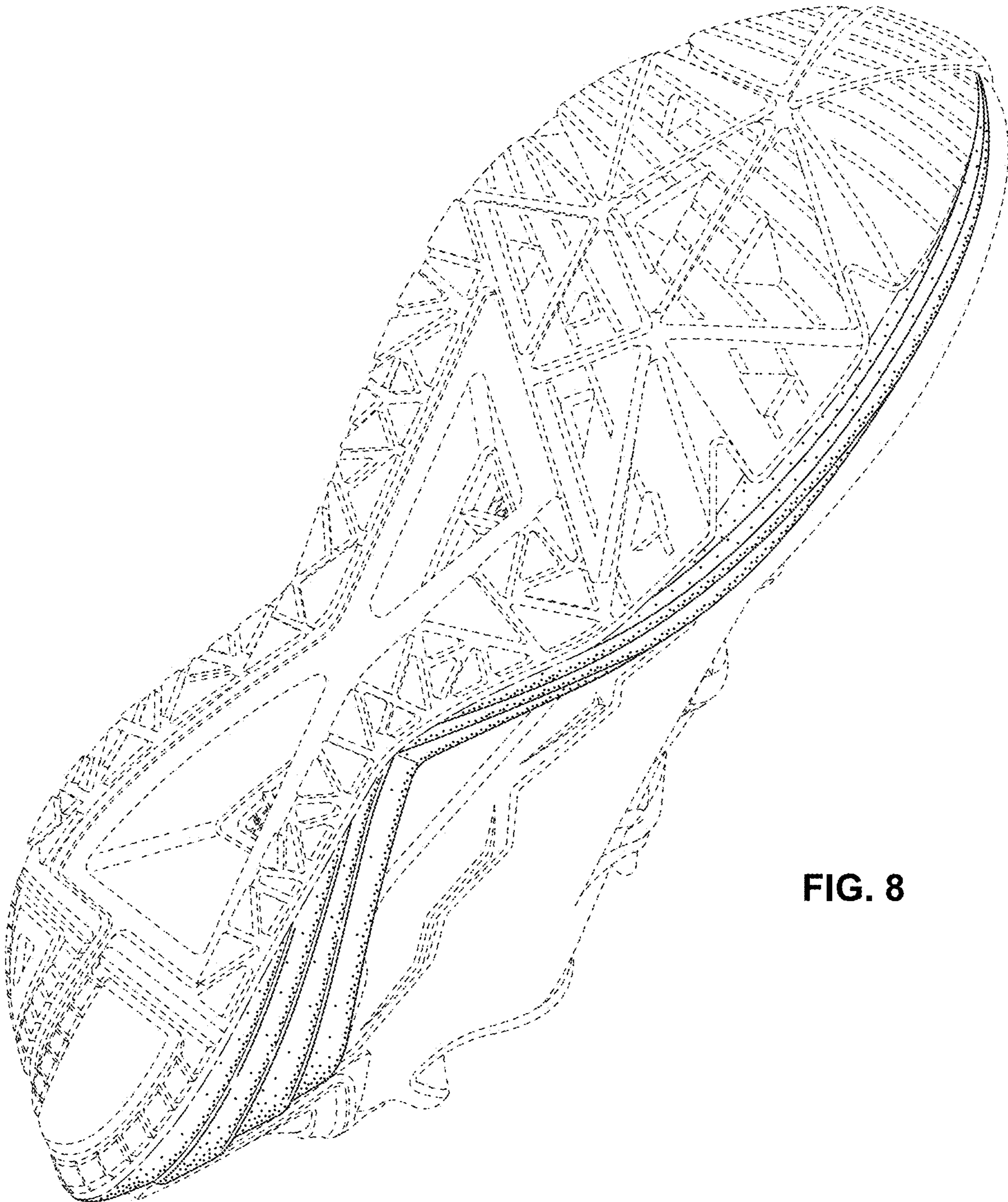

FIG. 8