



US00D946251S

(12) **United States Design Patent**  
**Ellington**

(10) **Patent No.:** **US D946,251 S**

(45) **Date of Patent:** **\*\* \*Mar. 22, 2022**

- (54) **COVER FOR A CLEATED SHOE**
- (71) Applicant: **Randall Ellington**, Laurel, MD (US)
- (72) Inventor: **Randall Ellington**, Laurel, MD (US)
- (\*) Notice: This patent is subject to a terminal disclaimer.
- (\*\*) Term: **15 Years**

D402,796 S *	12/1998	Garcia .....	D2/943
D494,746 S *	8/2004	Gomez-Tagle-Mendez .....	D2/916
D509,586 S *	9/2005	Lee .....	D24/128
D577,441 S *	9/2008	Burnett .....	D21/685
D718,024 S *	11/2014	Wells .....	D2/943
D722,424 S *	2/2015	Schoenhaus .....	D2/919
D838,446 S *	1/2019	Mantey .....	A43B 3/106
			D2/914
D901,138 S *	11/2020	Delong .....	A43B 3/106
			D2/914

- (21) Appl. No.: **29/703,700**
- (22) Filed: **Aug. 29, 2019**
- (51) **LOC (13) Cl.** ..... **02-04**
- (52) **U.S. Cl.**  
USPC ..... **D2/946**
- (58) **Field of Classification Search**  
USPC ..... D2/902, 907, 908, 944-946, 969,  
D2/972-974, 976, 977  
CPC .. A43B 23/24; A43B 5/00; A43B 5/06; A43B  
5/10; A43C 19/00; A43C 7/00; A43C  
7/005; A43C 7/04; A43C 7/06; A43C  
7/08; F16G 11/105  
See application file for complete search history.

\* cited by examiner

*Primary Examiner* — Kevin K Rudzinski  
*Assistant Examiner* — Clare Ann Gannon  
 (74) *Attorney, Agent, or Firm* — Sanchelima &  
 Associates, P.A.; Christian Sanchelima; Jesus Sanchelima

(57) **CLAIM**

The ornamental design for a cover for a cleated shoe, as shown and described.

**DESCRIPTION**

FIG. 1 is a perspective view of a cover for a cleated shoe showing my new design, shown in a position of use with a shoe;  
 FIG. 2 is a left side elevational view thereof;  
 FIG. 3 is a right side elevational view thereof;  
 FIG. 4 is a front elevational view thereof;  
 FIG. 5 is a rear elevational view thereof;  
 FIG. 6 is a top planar view thereof; and,  
 FIG. 7 is a bottom planar view thereof showing my design.  
 The broken lines depicting a shoe represent environment that forms no part of the claimed design.

**1 Claim, 4 Drawing Sheets**

- (56) **References Cited**  
U.S. PATENT DOCUMENTS  
D163,903 S \* 7/1951 Singer ..... D2/919  
3,775,873 A \* 12/1973 Small ..... A43B 3/106  
36/11.5  
4,751,784 A \* 6/1988 Petker ..... A43B 3/106  
36/11.5  
D361,424 S \* 8/1995 Medina ..... D2/914

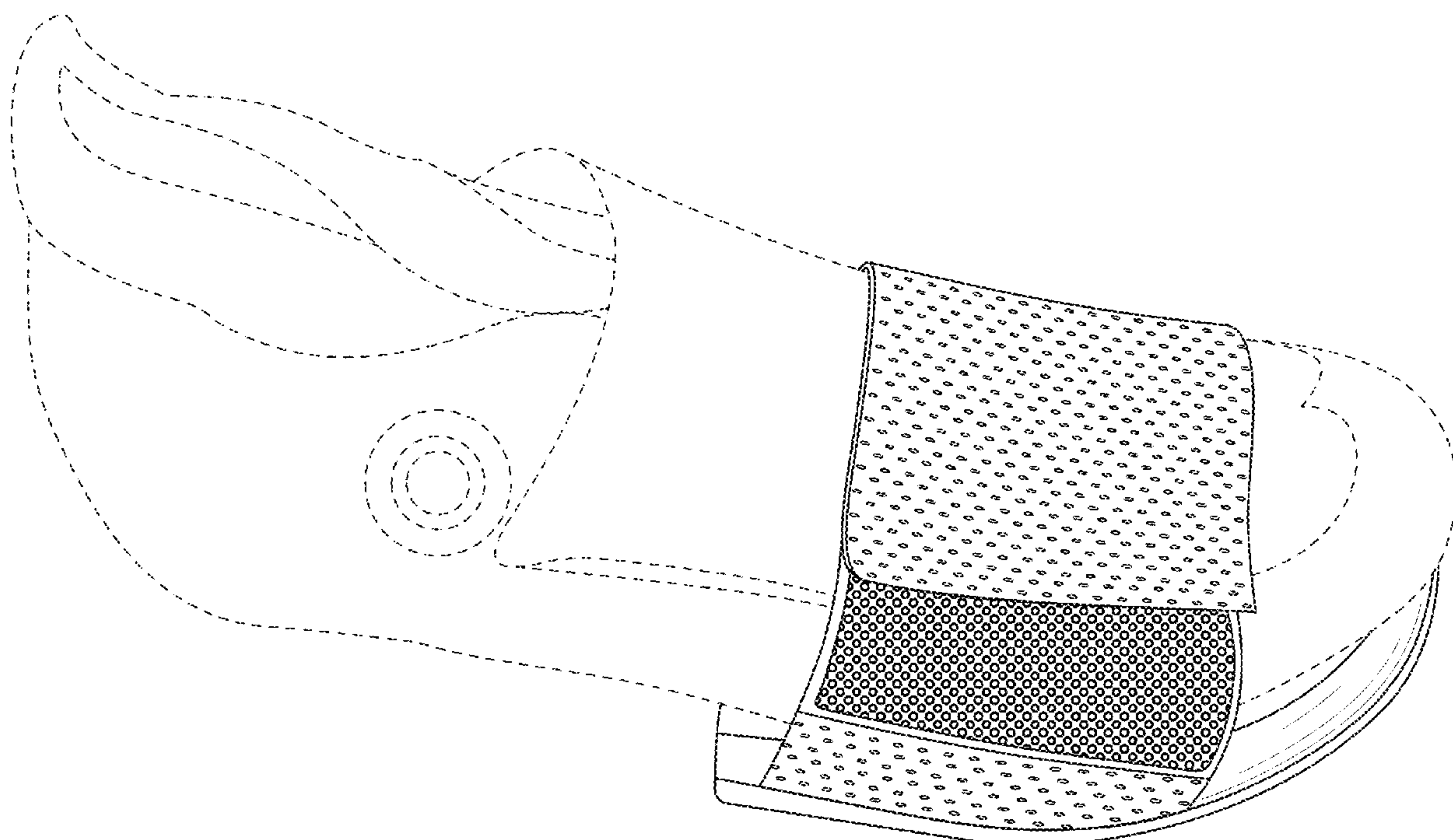

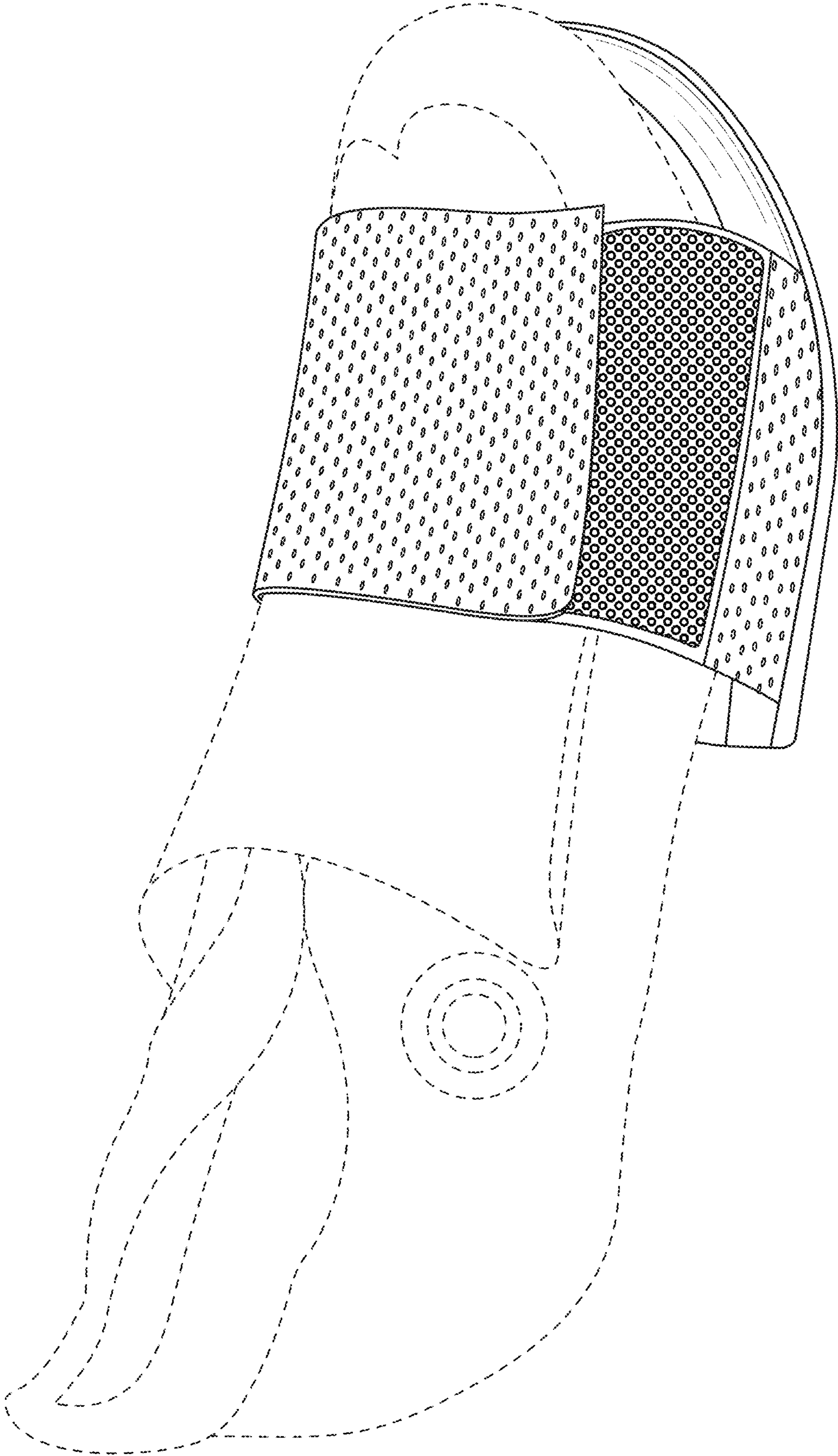

FIG. 1

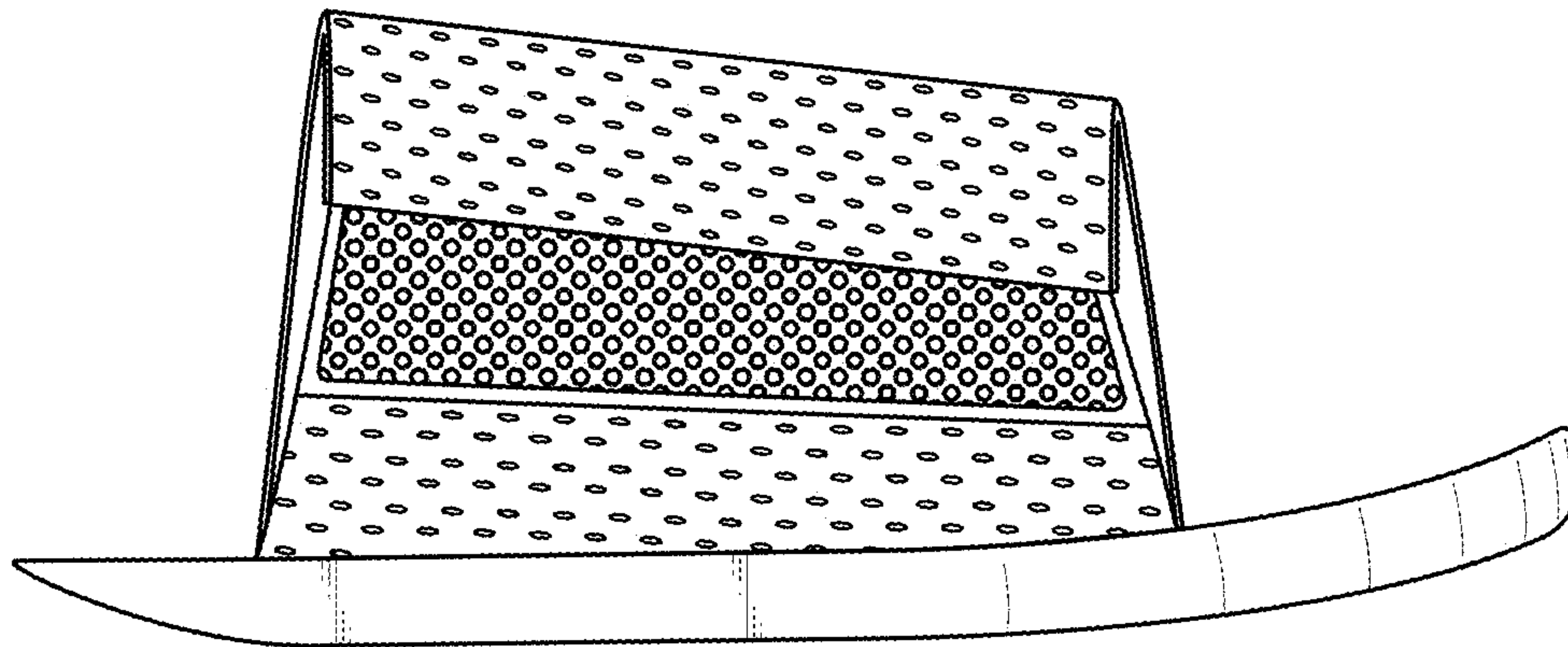

FIG. 2

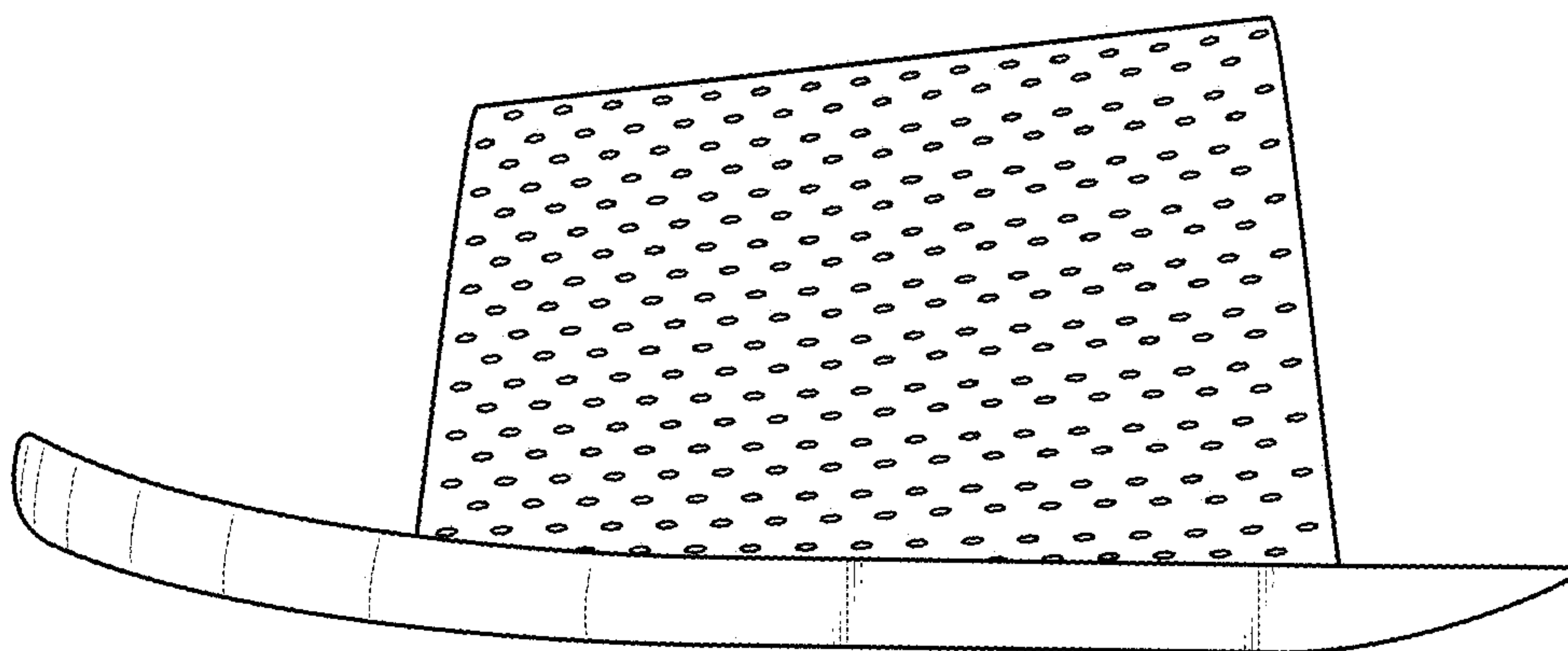

FIG. 3



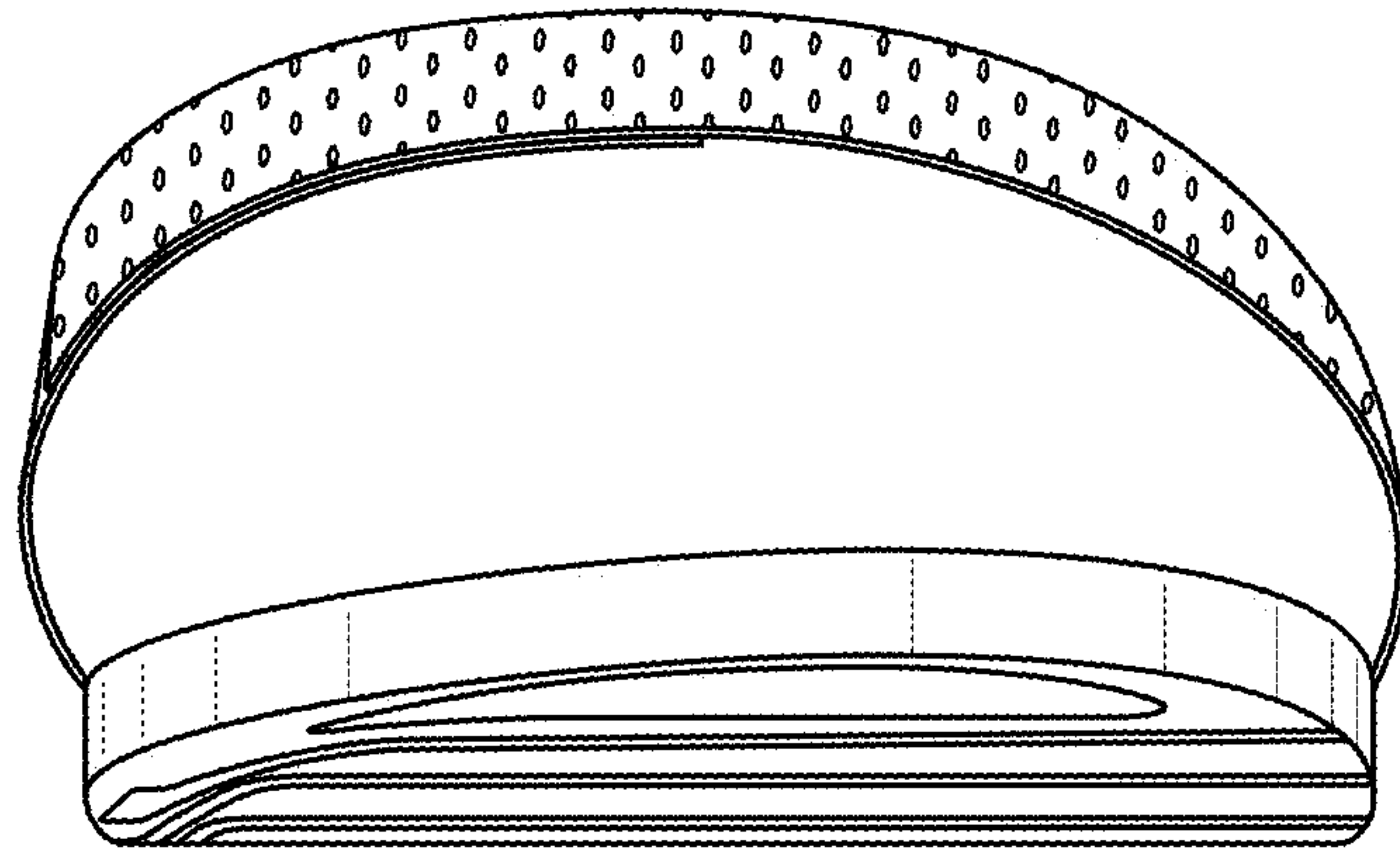

FIG. 4

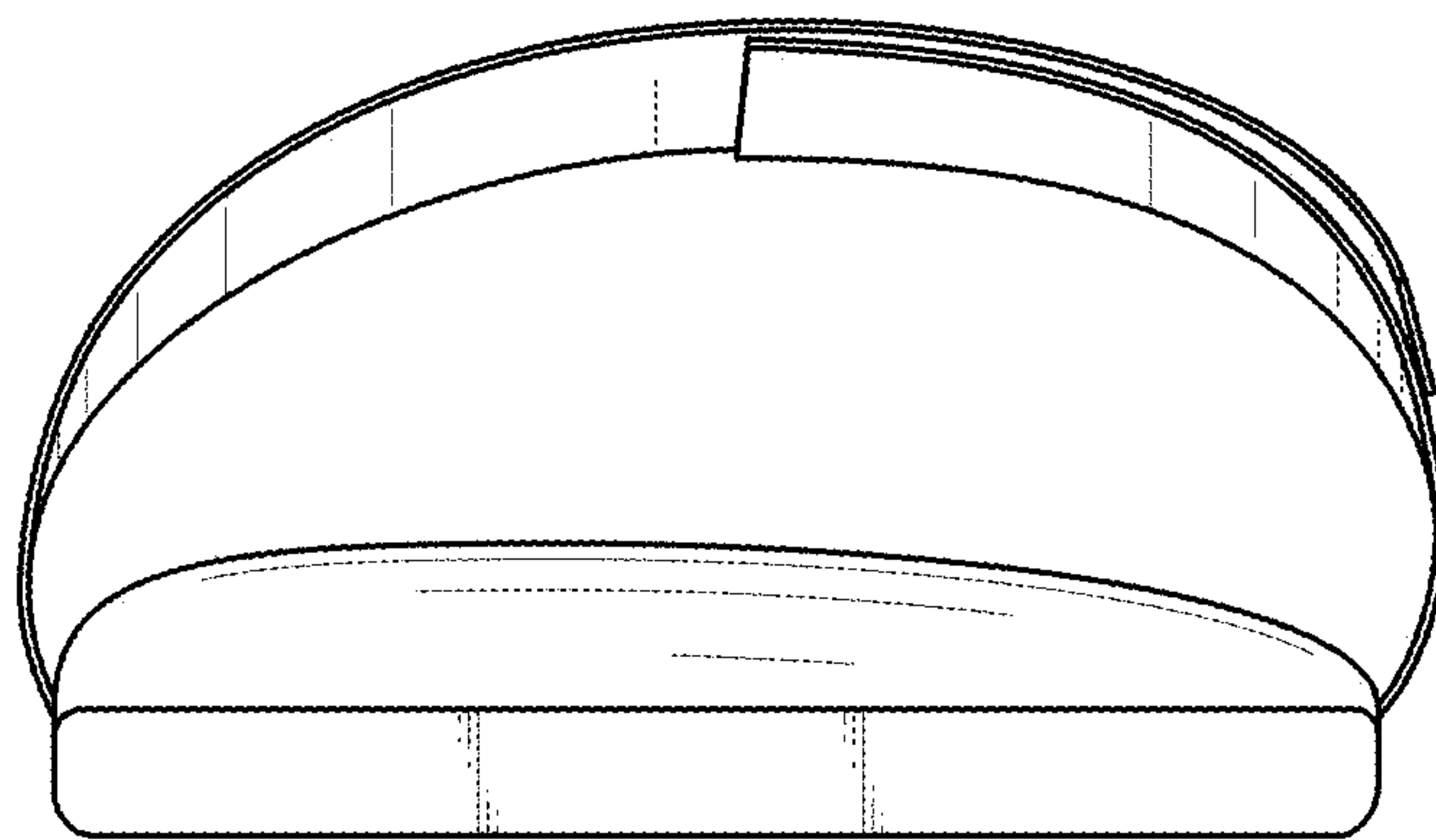

FIG. 5

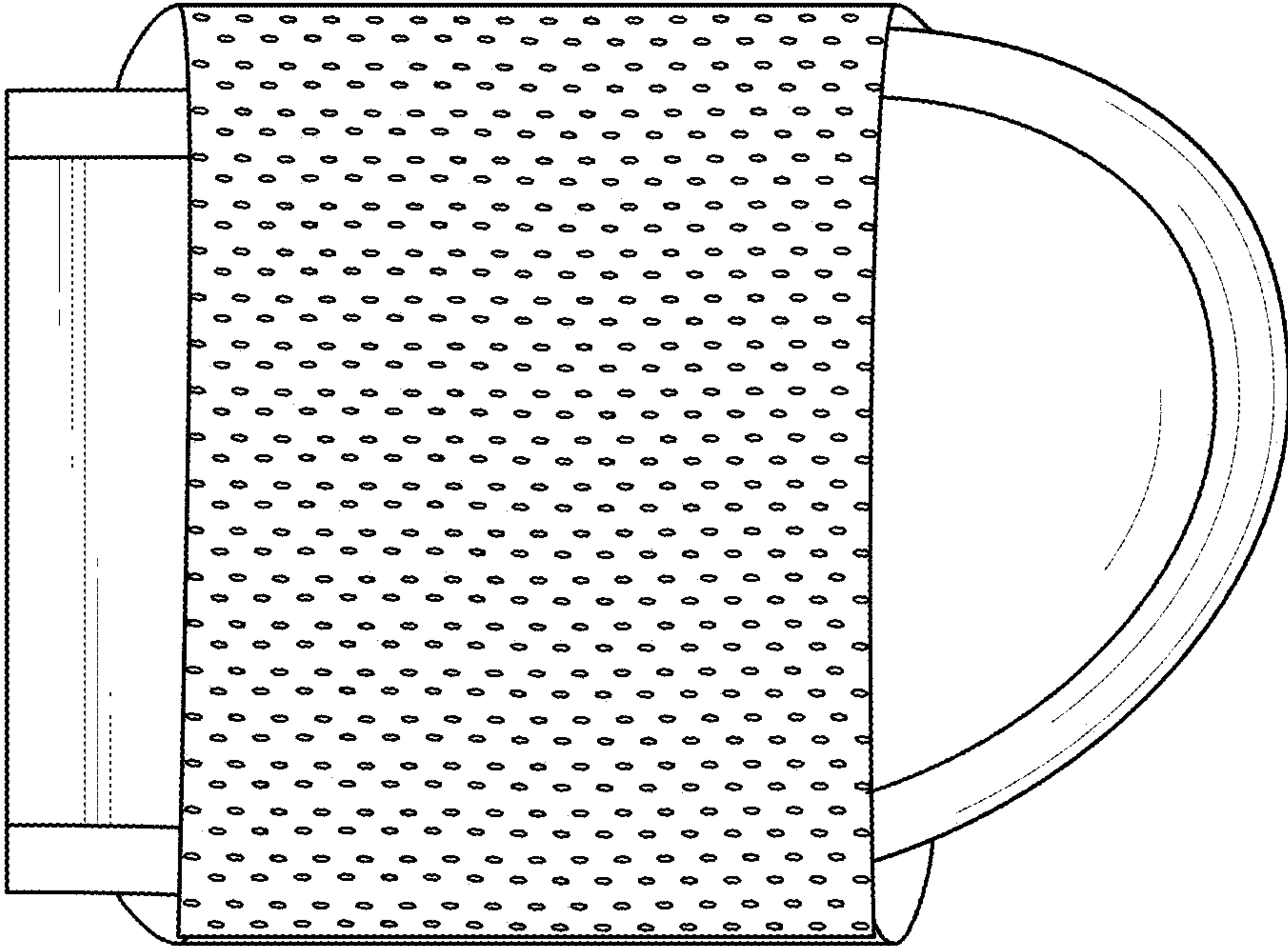

FIG. 6

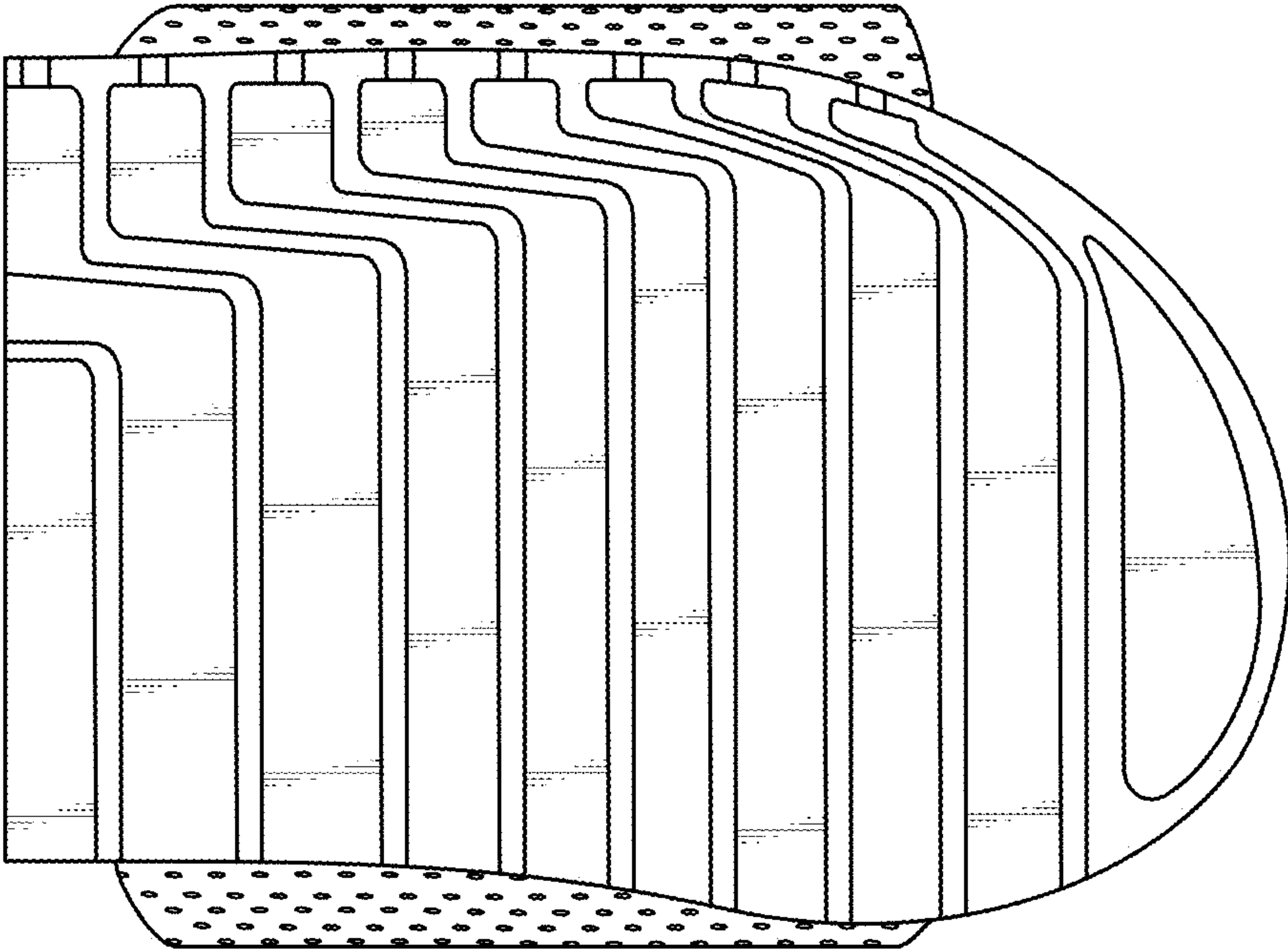

FIG. 7