

US00D946224S

(12) **United States Design Patent**  
**Cran**

(10) **Patent No.:** **US D946,224 S**

(45) **Date of Patent:** **\*\* Mar. 15, 2022**

- (54) **LAUNDRY MASHER**
- (71) Applicant: **MAKE GREAT SALES LIMITED,**  
Wan Chai (HK)
- (72) Inventor: **Bruce Peter Cran,** Ho Chi Minh (VN)
- (73) Assignee: **Make Great Sales Limited,** Hong  
Kong (HK)

- 8,136,437 B2 3/2012 Van Stratum et al.
- D663,399 S \* 7/2012 Browder ..... D23/366
- D663,405 S \* 7/2012 Browder ..... D23/366
- D685,073 S \* 6/2013 Gordon ..... D23/366
- 8,485,101 B2 7/2013 Frank
- D696,763 S \* 12/2013 Li ..... D23/366
- D727,742 S \* 4/2015 Jacobs ..... D9/662
- D739,764 S \* 9/2015 Blair ..... D9/629
- D752,731 S \* 3/2016 Ansley ..... D23/366
- 9,423,228 B2 8/2016 Moan et al.

(Continued)

(\*\*) Term: **15 Years**

(21) Appl. No.: **29/733,715**

(22) Filed: **May 6, 2020**

(51) **LOC (13) Cl.** ..... **15-05**

(52) **U.S. Cl.**  
USPC ..... **D32/29.1**

(58) **Field of Classification Search**  
USPC ..... D7/693; D9/504, 435, 626, 629, 662,  
D9/668; D22/122; D23/366; D30/121,  
D30/160; D32/1, 29.1  
CPC ..... B65D 51/248; B65D 45/04; A61L 9/12  
See application file for complete search history.

(56) **References Cited**

**U.S. PATENT DOCUMENTS**

- 5,240,450 A 8/1993 Graham
- D341,321 S 11/1993 De Silva
- 5,931,351 A \* 8/1999 Renualt ..... B65D 45/04  
222/182
- 5,975,983 A 11/1999 Panec
- D419,437 S \* 1/2000 Straeten ..... D9/668
- D423,360 S \* 4/2000 Hirato ..... D9/504
- 6,237,788 B1 \* 5/2001 Shuen ..... A61L 9/12  
206/457
- D574,234 S \* 8/2008 Lobo ..... D9/435
- 7,481,727 B2 1/2009 Chia
- D621,494 S \* 8/2010 Li ..... D23/366
- D630,912 S \* 1/2011 Wong ..... D7/693
- D650,056 S \* 12/2011 Li ..... D23/366

**OTHER PUBLICATIONS**

Dryer Masher <https://mepinetwork.org/laundry-masher-reviews/> (Year: 2021).\*

(Continued)

*Primary Examiner* — Michelle E. Wilson  
*Assistant Examiner* — Richard E Yenchesky  
(74) *Attorney, Agent, or Firm* — Onello & Mello, LLP

(57) **CLAIM**

The ornamental design for a laundry masher, as shown and described.

**DESCRIPTION**

FIG. 1 is an isometric view of a laundry masher, in accordance with the design;  
FIG. 2 is a left-side view of the laundry masher of FIG. 1;  
FIG. 3 is a right-side view of the laundry masher of FIG. 1;  
FIG. 4 is a front view of the laundry masher of FIG. 1;  
FIG. 5 is a rear of the laundry masher of FIG. 1;  
FIG. 6 is a top view of the laundry masher of FIG. 1; and,  
FIG. 7 is a bottom view of the laundry masher of FIG. 1.  
In the drawings, broken line areas illustrate environmental subject matter or boundaries that form no part of the claimed design.

**1 Claim, 6 Drawing Sheets**

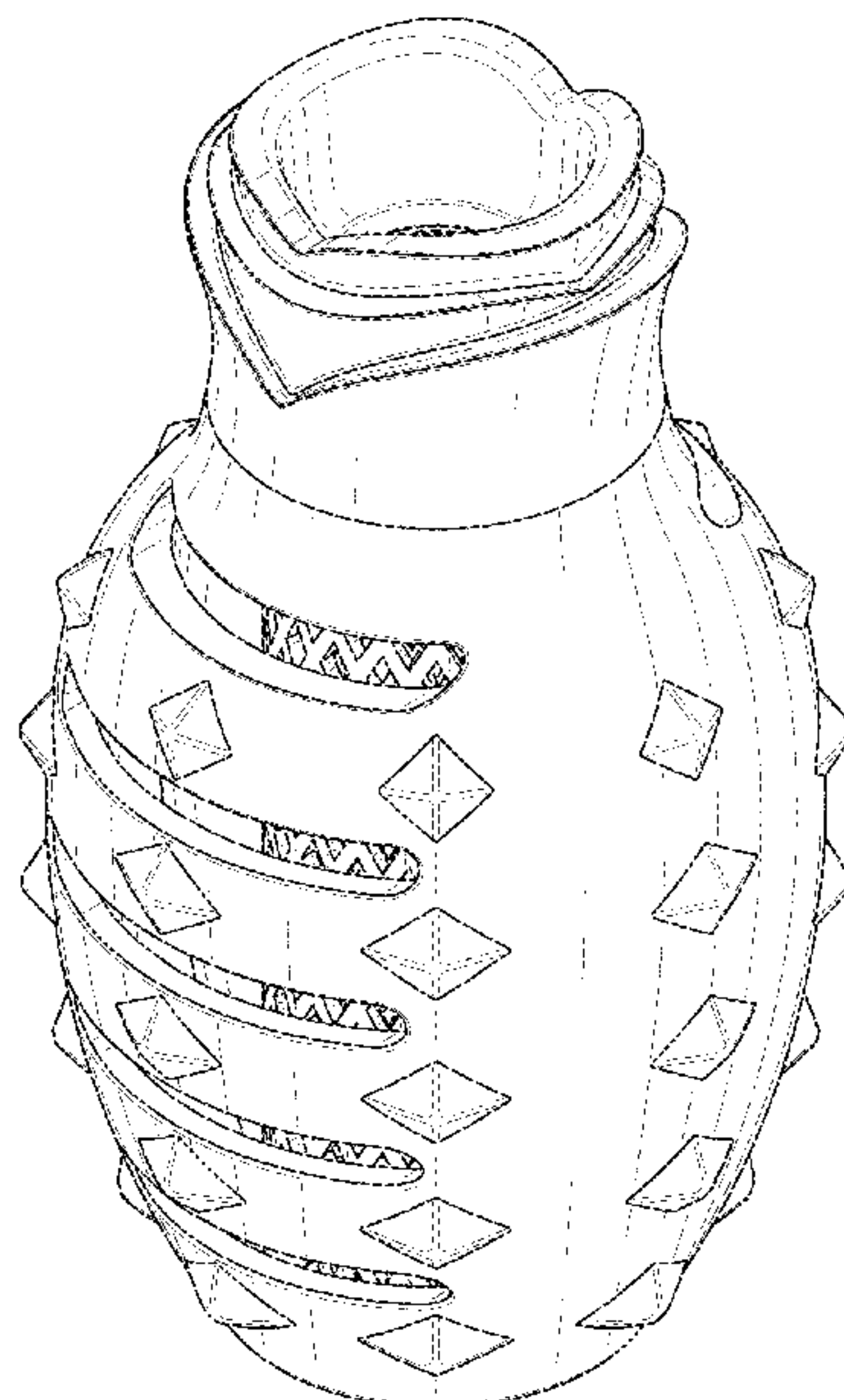

(56)

**References Cited**

U.S. PATENT DOCUMENTS

9,470,495 B2 10/2016 Kravel  
 9,482,503 B2 11/2016 Tippmann, Jr. et al.  
 9,500,458 B2 11/2016 Wigg et al.  
 D787,842 S 5/2017 Lenton  
 9,738,947 B1 8/2017 Deshpande et al.  
 D829,562 S \* 10/2018 Von Drachenberg ..... D9/626  
 D848,096 S \* 5/2019 Loebach ..... D32/29.1  
 D850,016 S \* 5/2019 Bolter ..... D30/121  
 D871,603 S 12/2019 Spratt  
 D881,481 S \* 4/2020 Baker ..... D30/160  
 D887,522 S \* 6/2020 Swietoslowski ..... D22/122  
 D887,523 S \* 6/2020 Swietoslowski ..... D22/122  
 D888,186 S \* 6/2020 Swietoslowski ..... D22/122  
 D901,106 S \* 11/2020 Zhao ..... D32/1  
 D904,553 S \* 12/2020 Swietoslowski ..... D22/122  
 10,996,034 B2 5/2021 Wustlich et al.  
 11,054,231 B2 7/2021 Habel et al.  
 2008/0242457 A1 10/2008 Chia  
 2011/0232466 A1 9/2011 Stratum et al.  
 2011/0306446 A1 12/2011 Frank  
 2013/0255525 A1 10/2013 Silva

2015/0198428 A1 7/2015 Tippmann, Jr. et al.  
 2015/0292848 A1 10/2015 Wigg et al.  
 2016/0047641 A1 2/2016 Moan et al.  
 2016/0273898 A1 9/2016 Kravel  
 2016/0367846 A1 12/2016 Haines  
 2017/0007865 A1 1/2017 Dor-El et al.  
 2017/0240986 A1 8/2017 Deshpande et al.  
 2017/0367460 A1 \* 12/2017 Martines ..... B65D 51/248  
 2018/0259308 A1 9/2018 Salmon  
 2018/0306561 A1 10/2018 Fernandez De Castro  
 2020/0056869 A1 2/2020 Habel et al.  
 2020/0149851 A1 5/2020 Wustlich et al.  
 2020/0309493 A1 10/2020 Wustlich et al.  
 2021/0018306 A1 1/2021 Helge

OTHER PUBLICATIONS

Laundry masher <https://inc500conference.com/laundry-masher-reviews/> (Year: 2021).  
 “Laundry Masher—Grenade” product information, accessed on the Internet. <https://www.laundrymasher.com/laundry-masher-grenade-5ff4fd805f0f4941682486d8.html>.

\* cited by examiner

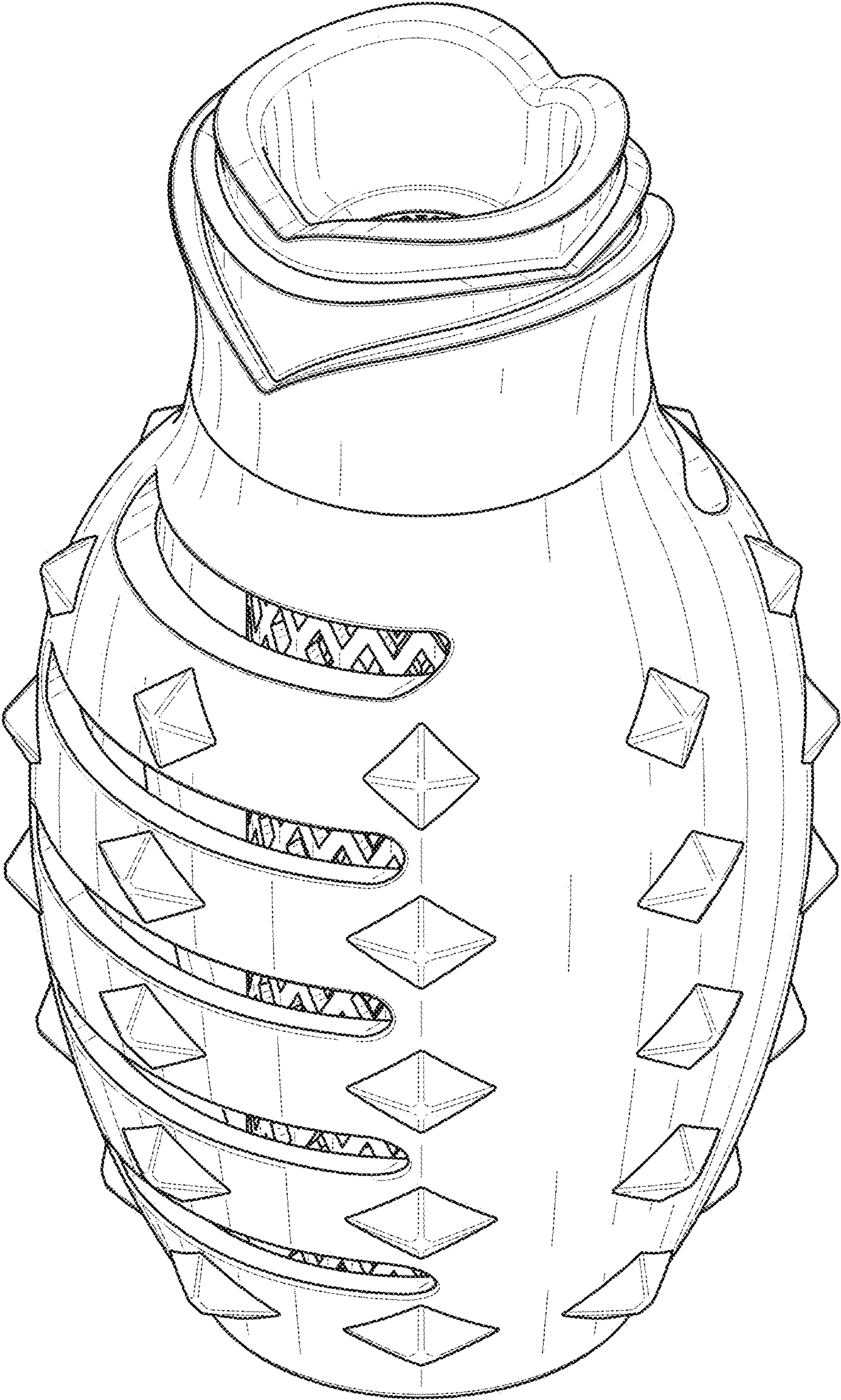

FIG. 1



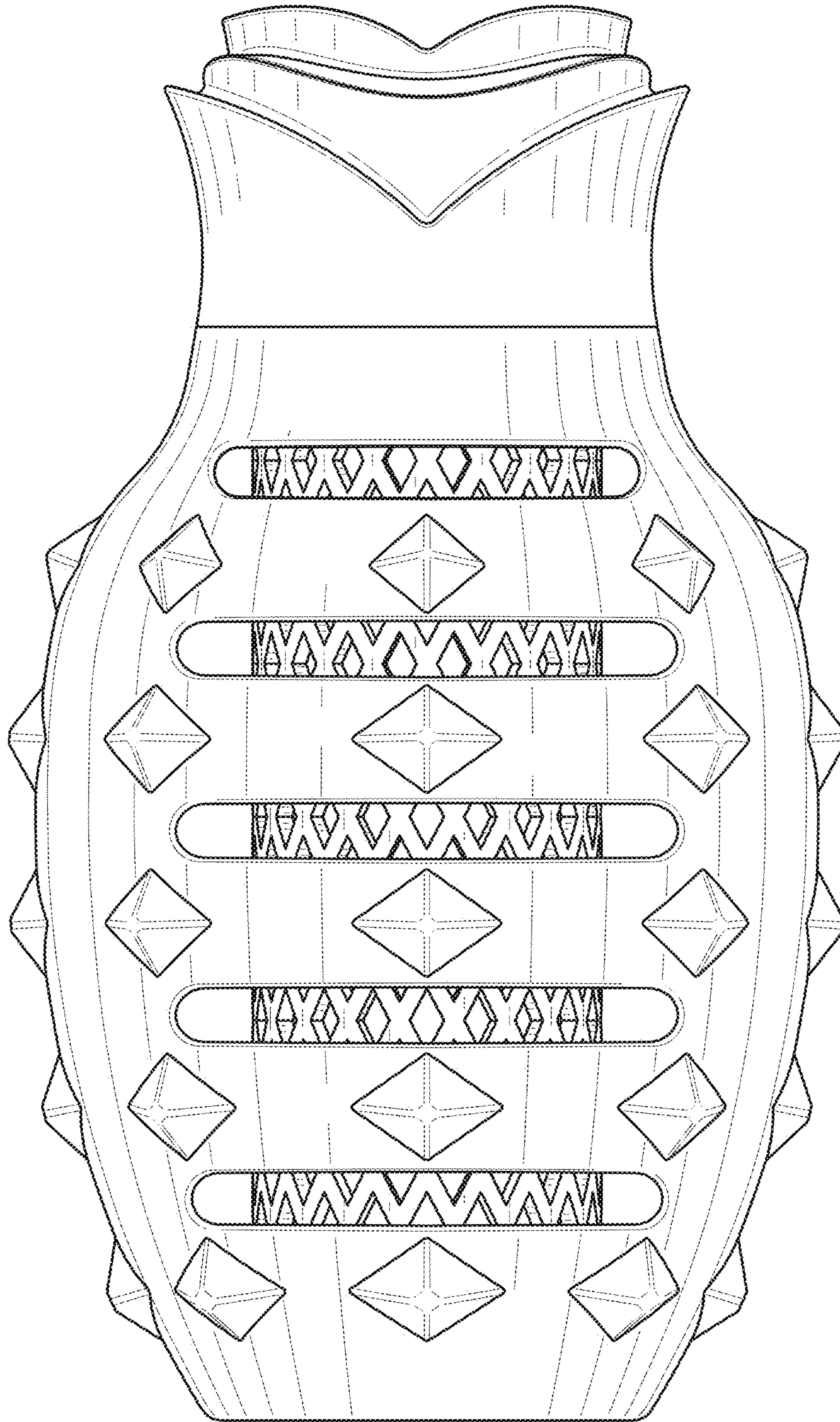

FIG. 2

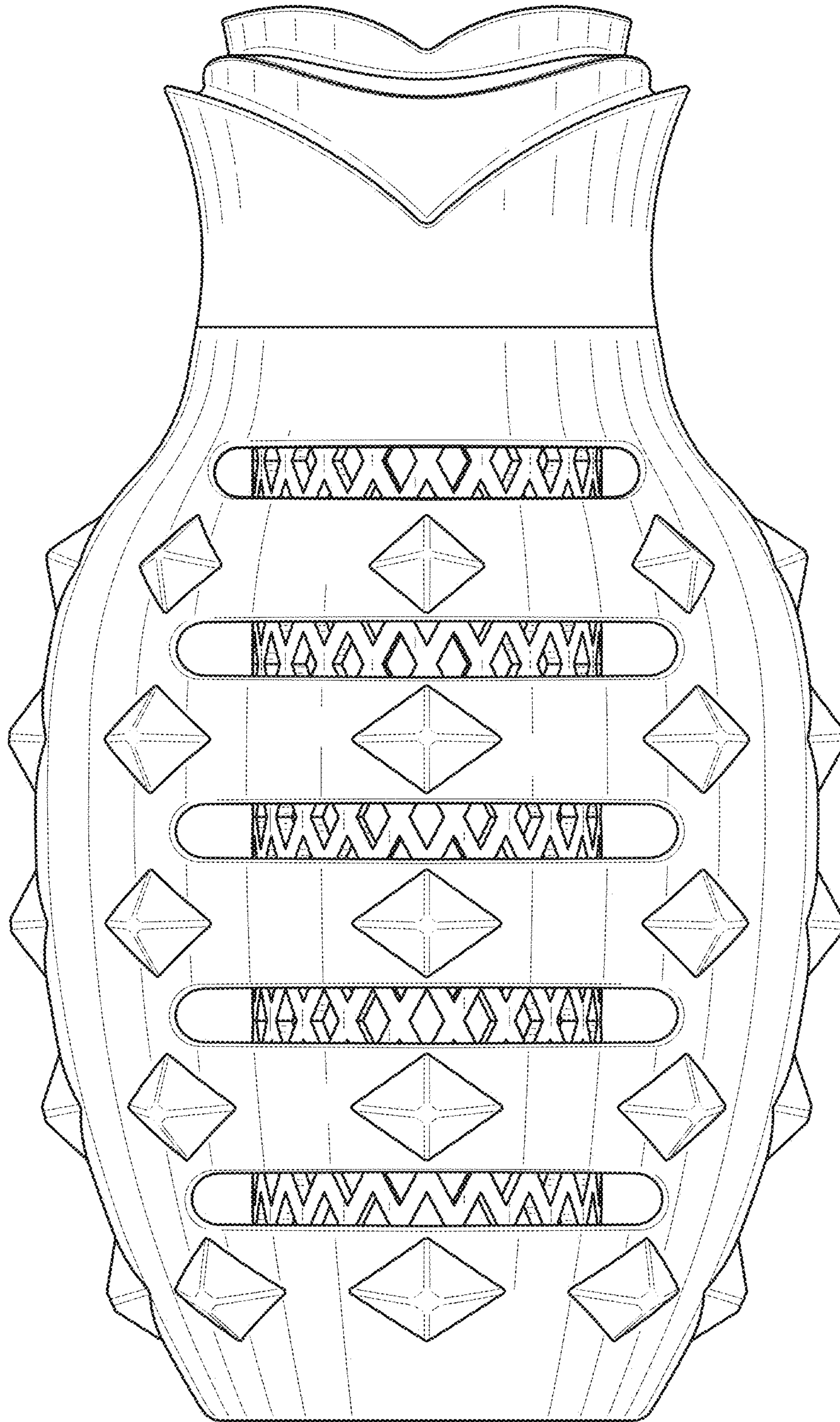

FIG. 3

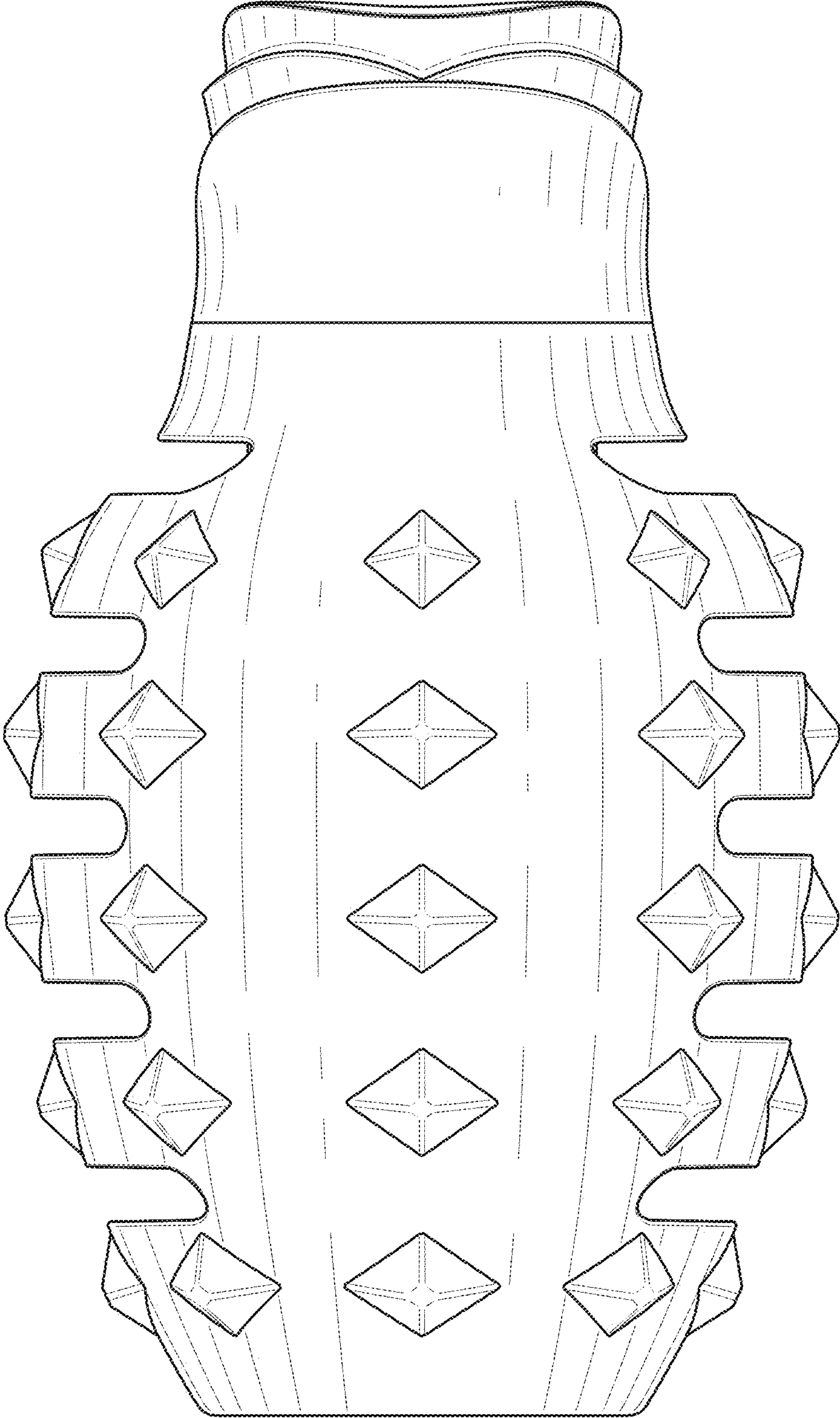

FIG. 4



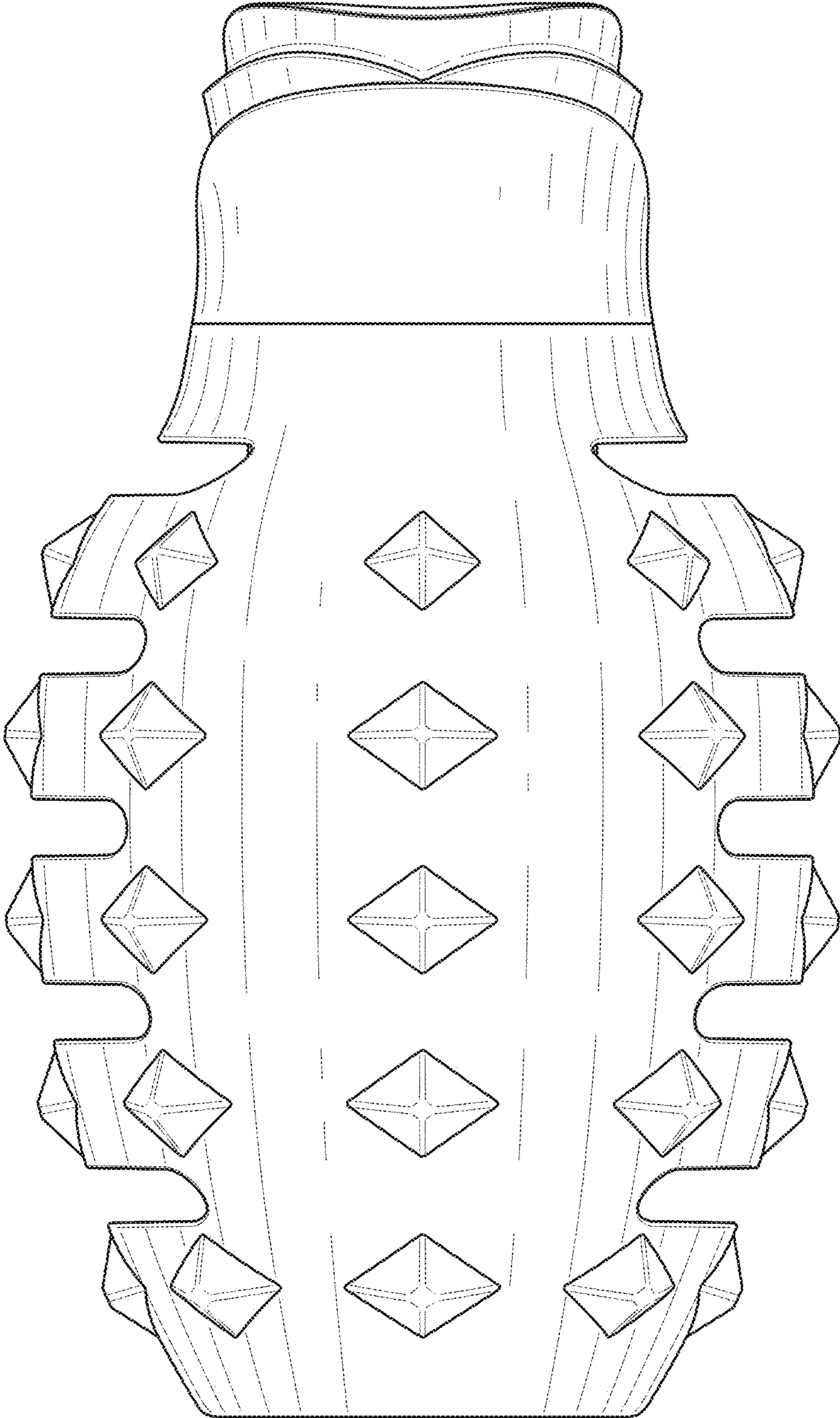

FIG. 5

FIG. 6

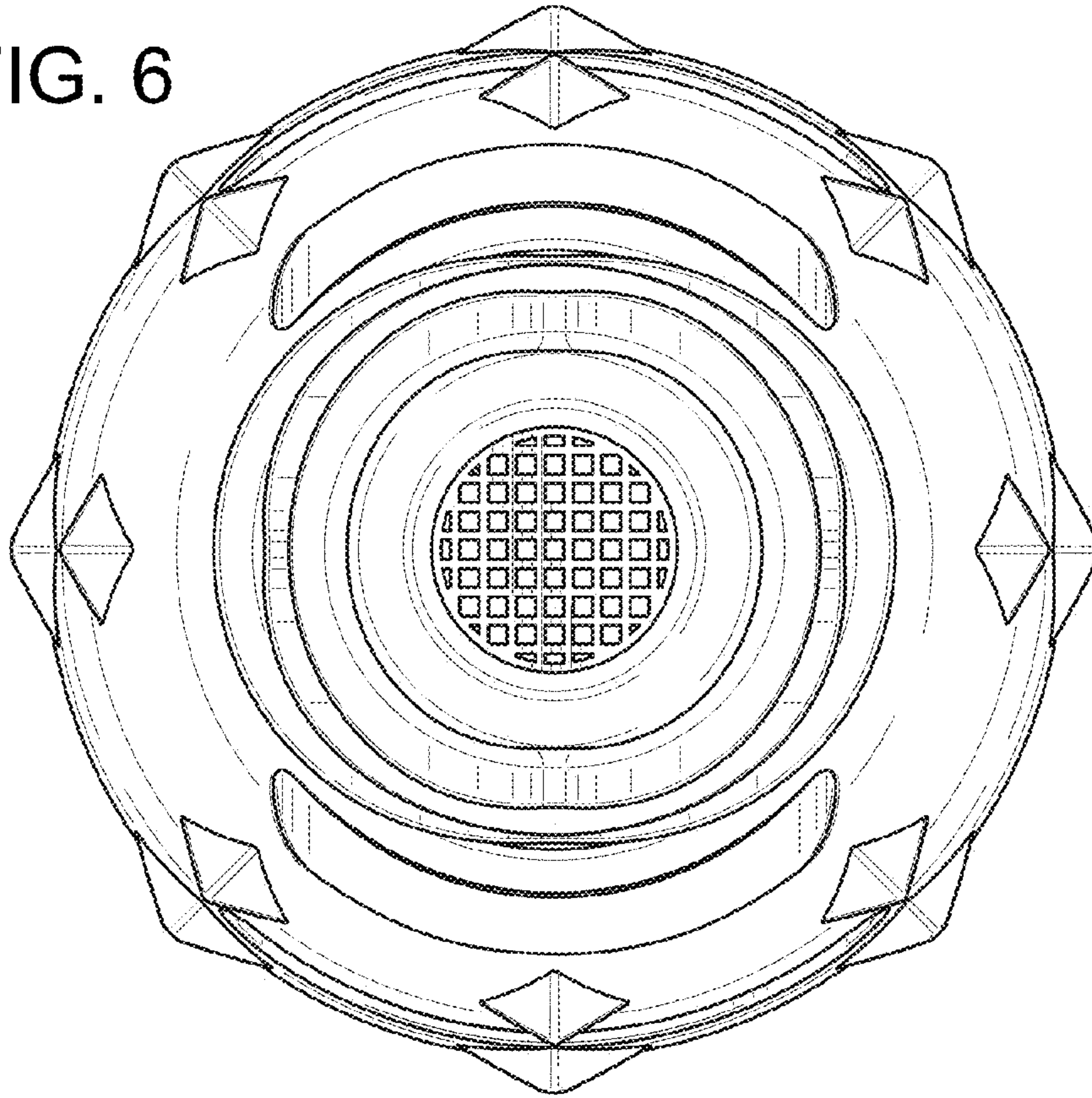

FIG. 7

