

US00D946198S

(12) **United States Design Patent**
Zhong

(10) **Patent No.:** **US D946,198 S**
(45) **Date of Patent:** **** Mar. 15, 2022**

(54) **PROJECTION LAMP**

(71) Applicant: **Jinger Zhong**, Shenzhen (CN)

(72) Inventor: **Jinger Zhong**, Shenzhen (CN)

(**) Term: **15 Years**

(21) Appl. No.: **29/779,309**

(22) Filed: **Apr. 19, 2021**

(51) **LOC (13) Cl.** **26-05**

(52) **U.S. Cl.**
USPC **D26/93**

(58) **Field of Classification Search**
USPC D26/21, 60-61, 63-68, 85-86, 93,
D26/104-105, 138

CPC ... A61N 5/06; F21S 6/00; G03B 15/02; F21V
21/08

See application file for complete search history.

(56) **References Cited**

U.S. PATENT DOCUMENTS

D282,106 S *	1/1986	Freytag	D26/24
D284,109 S *	6/1986	Seal, Jr.	D26/24
D346,230 S *	4/1994	Ueda	D26/28
D498,550 S *	11/2004	Chen	D26/28
D511,586 S *	11/2005	Yeh	D26/37
D541,447 S *	4/2007	Ueda	D26/28
D569,023 S *	5/2008	Lee	D26/60
D604,887 S *	11/2009	Sanoner	D26/105
D609,379 S *	2/2010	Lee	D26/60
D617,931 S *	6/2010	Chen	D26/63
D629,131 S *	12/2010	Seal	D26/60
D662,636 S *	6/2012	Katsaros	D26/60

D754,900 S *	4/2016	Mumma	D26/60
D846,781 S *	4/2019	Lee	D26/38
D865,252 S *	10/2019	Peters	D26/60
D891,682 S	7/2020	Wei	
D911,561 S *	2/2021	Heggland	D26/28
D914,940 S *	3/2021	Hamasaki	D26/60
D914,957 S	3/2021	Zeng	
D919,148 S *	5/2021	Shirota	D26/60
D927,035 S *	8/2021	Pavitt	D26/65
2019/0151674 A1 *	5/2019	Yoon	A61N 1/36

FOREIGN PATENT DOCUMENTS

GB 6114214 * 1/2021

* cited by examiner

Primary Examiner — John R Yeh

(57) **CLAIM**

The ornamental design for a projection lamp, as shown and described.

DESCRIPTION

FIG. 1 is a perspective view of a projection lamp showing my new design;

FIG. 2 is another perspective view thereof;

FIG. 3 is a front elevational view thereof;

FIG. 4 is a rear elevational view thereof;

FIG. 5 is a left side elevational view thereof;

FIG. 6 is a right side elevational view thereof;

FIG. 7 is a top plan view thereof; and,

FIG. 8 is a bottom plan view thereof.

The broken lines in the drawings depict portions of the projection lamp that form no part of the claimed design.

1 Claim, 8 Drawing Sheets

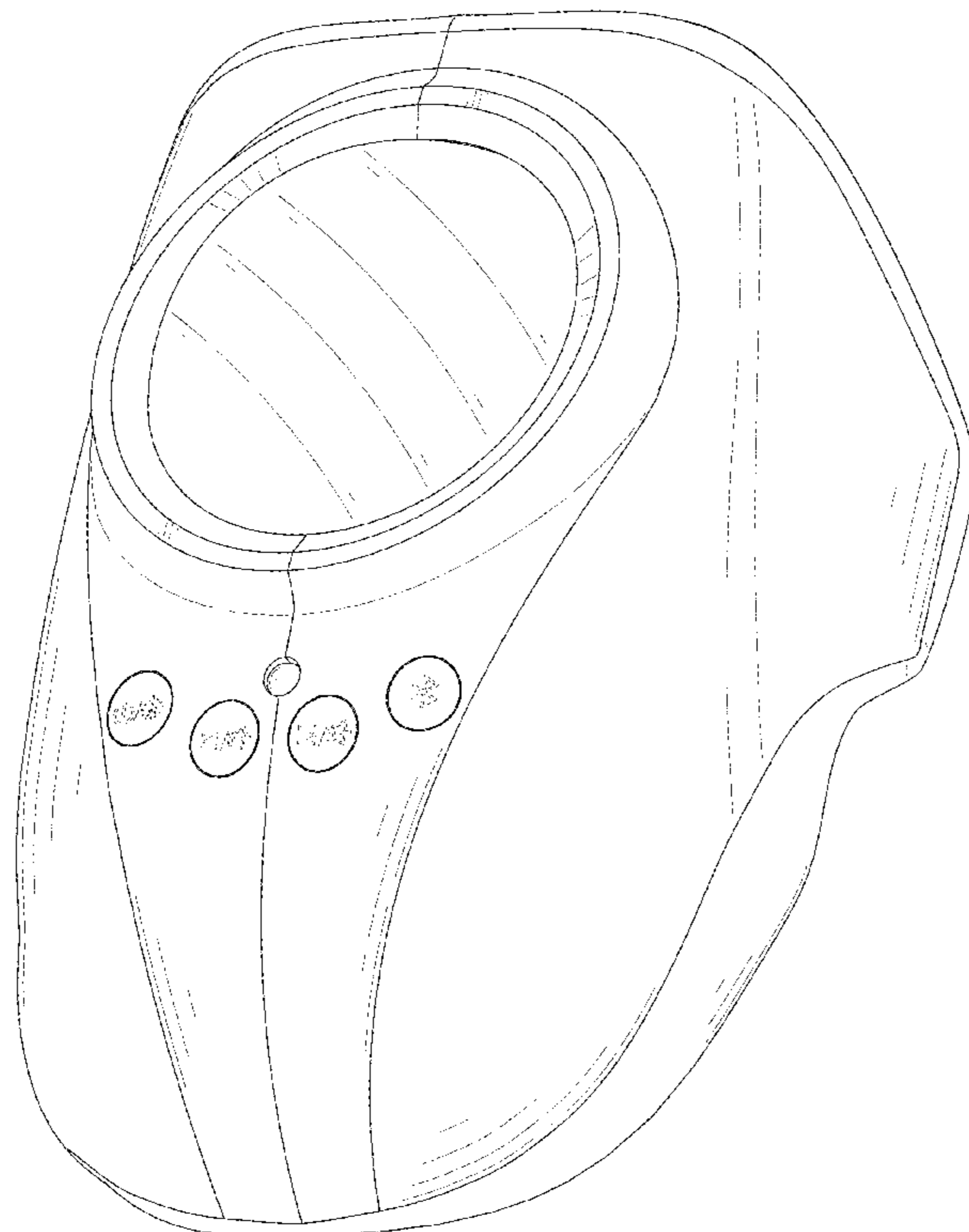

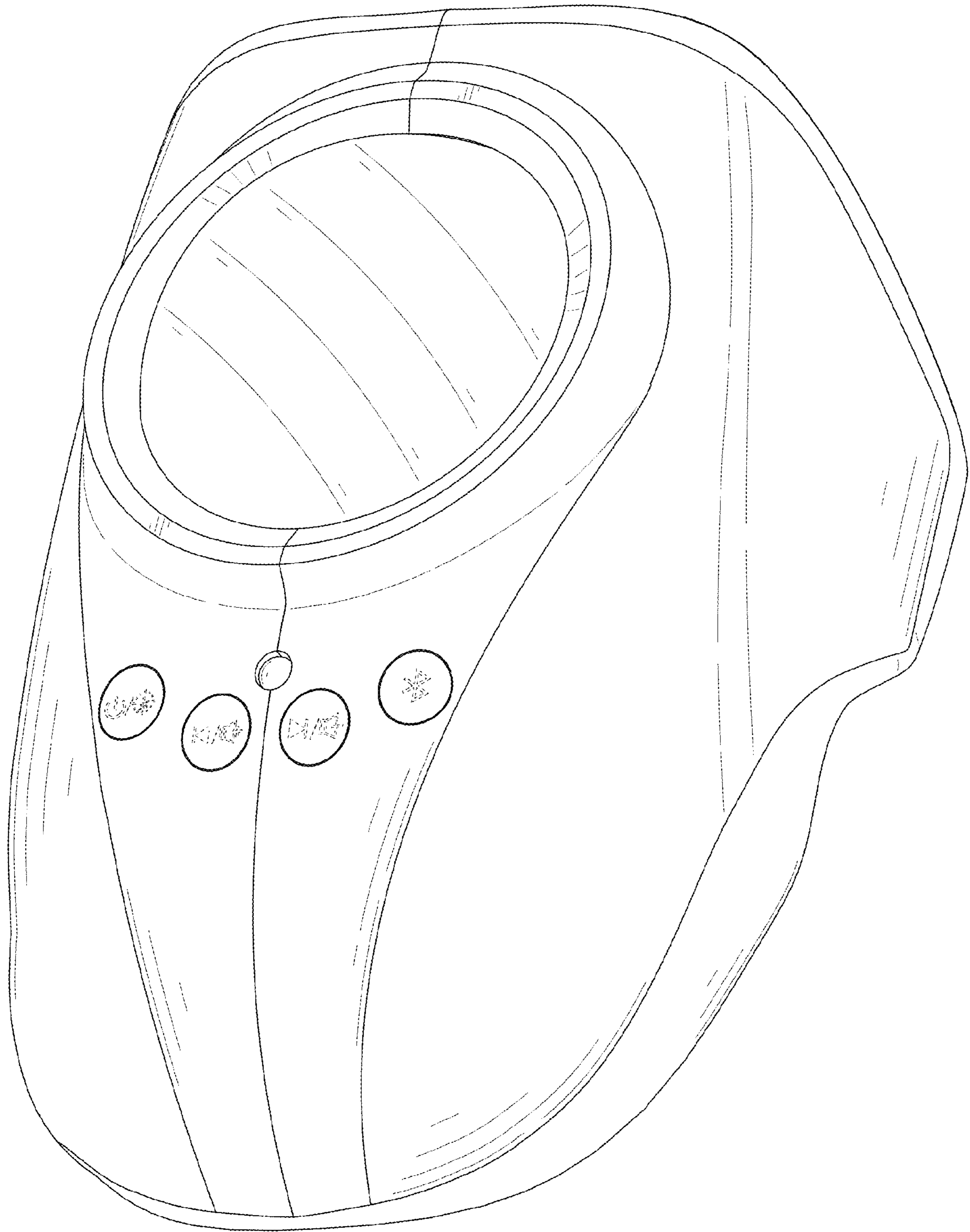

FIG. 1

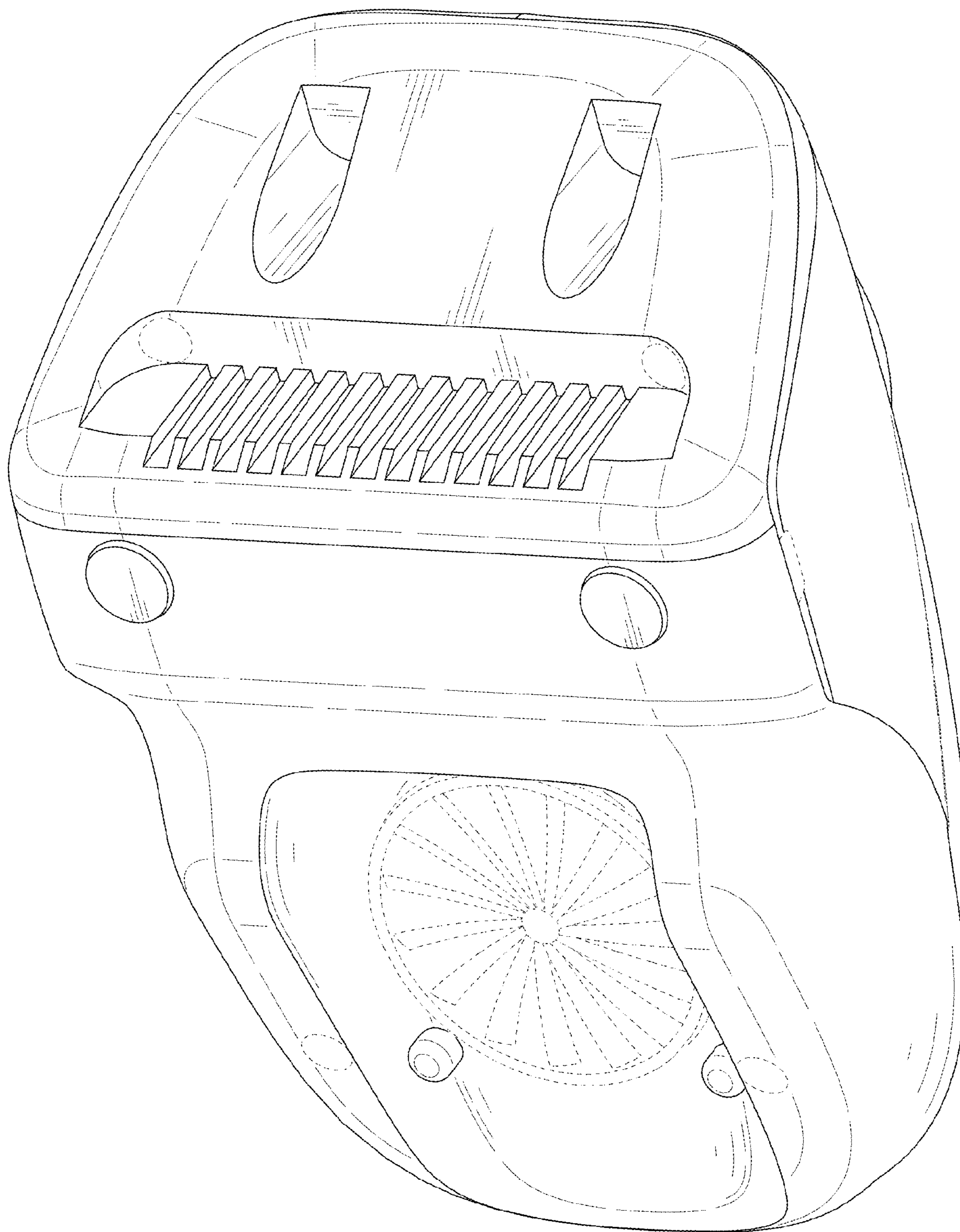

FIG. 2

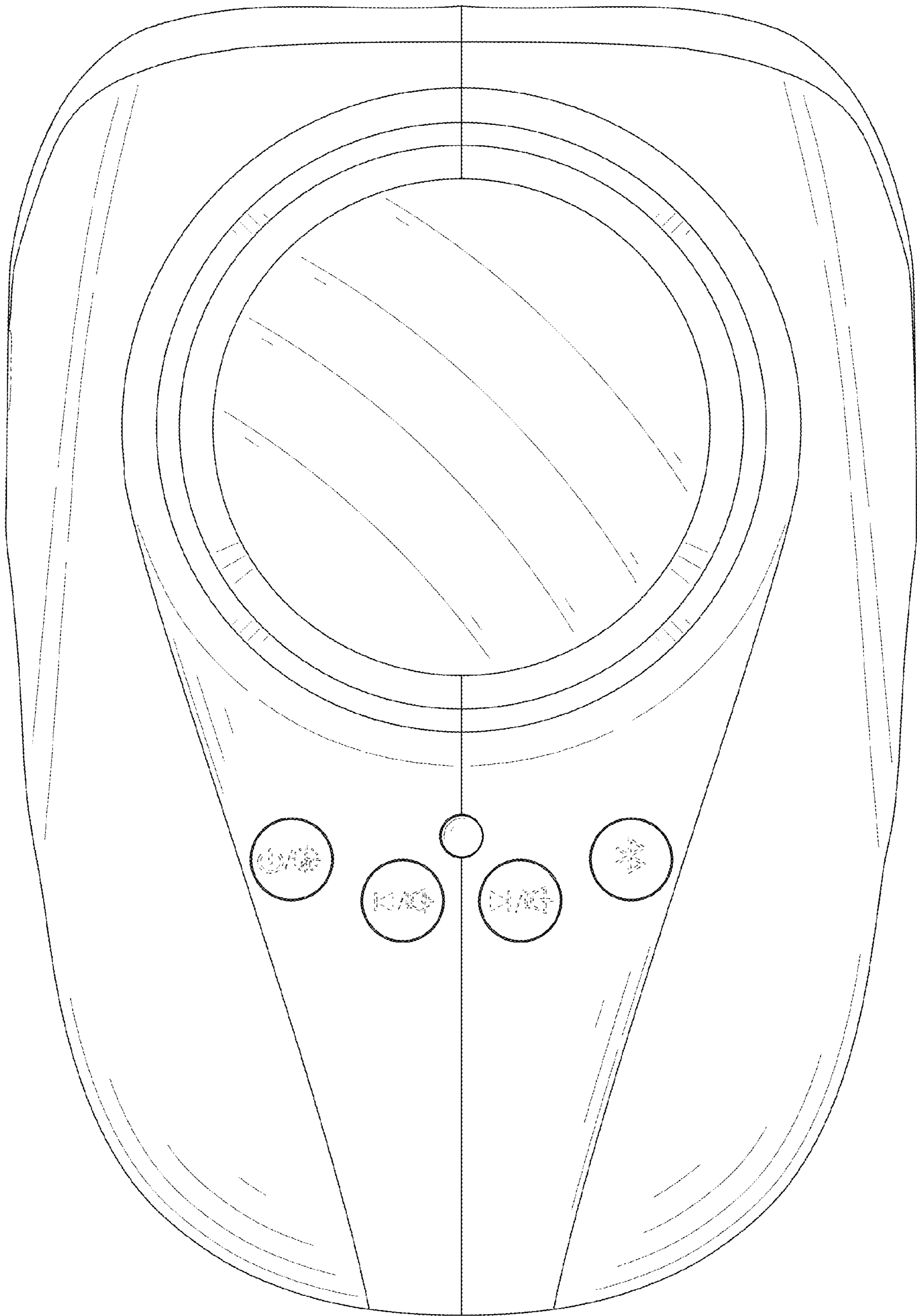

FIG. 3

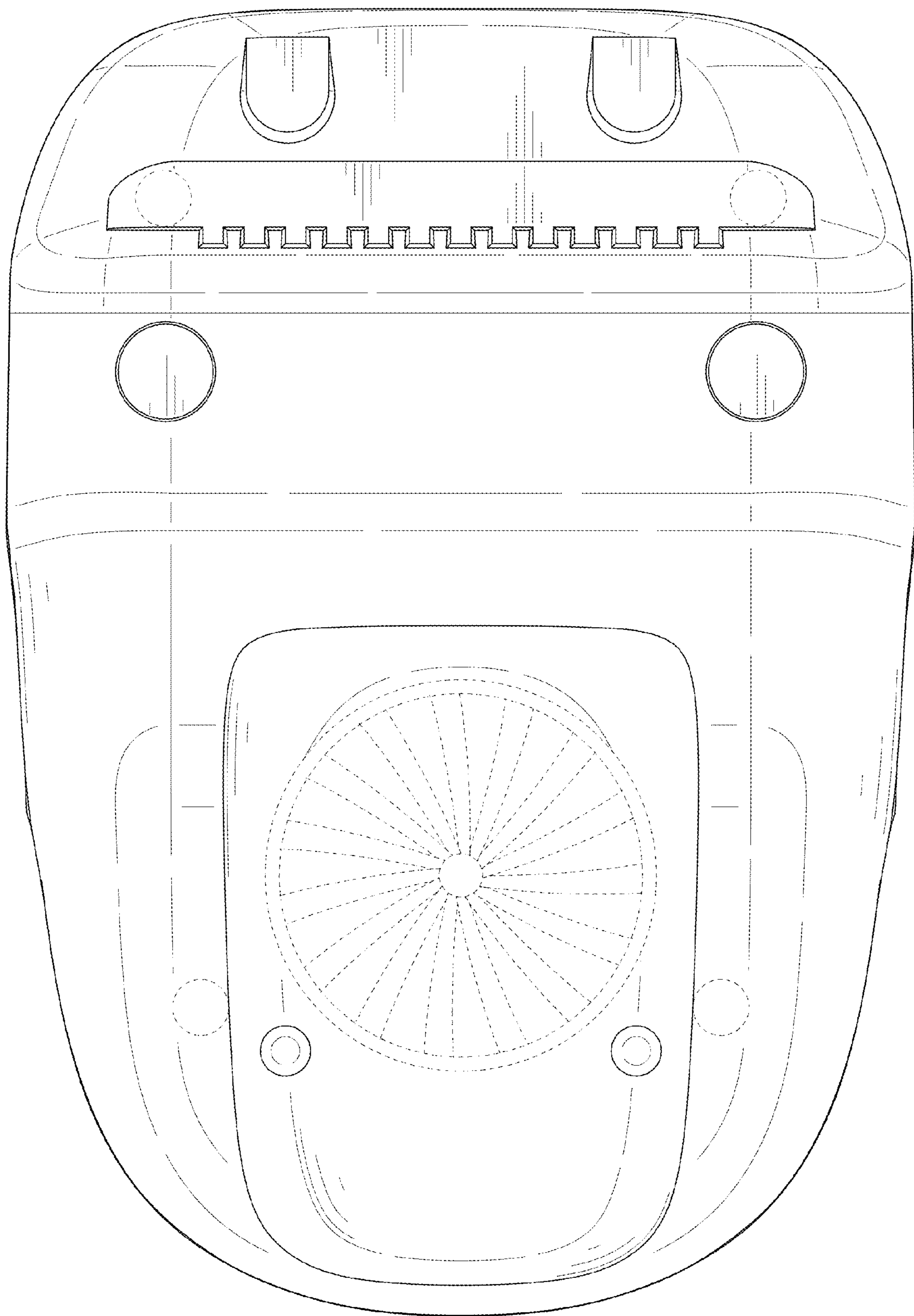

FIG. 4

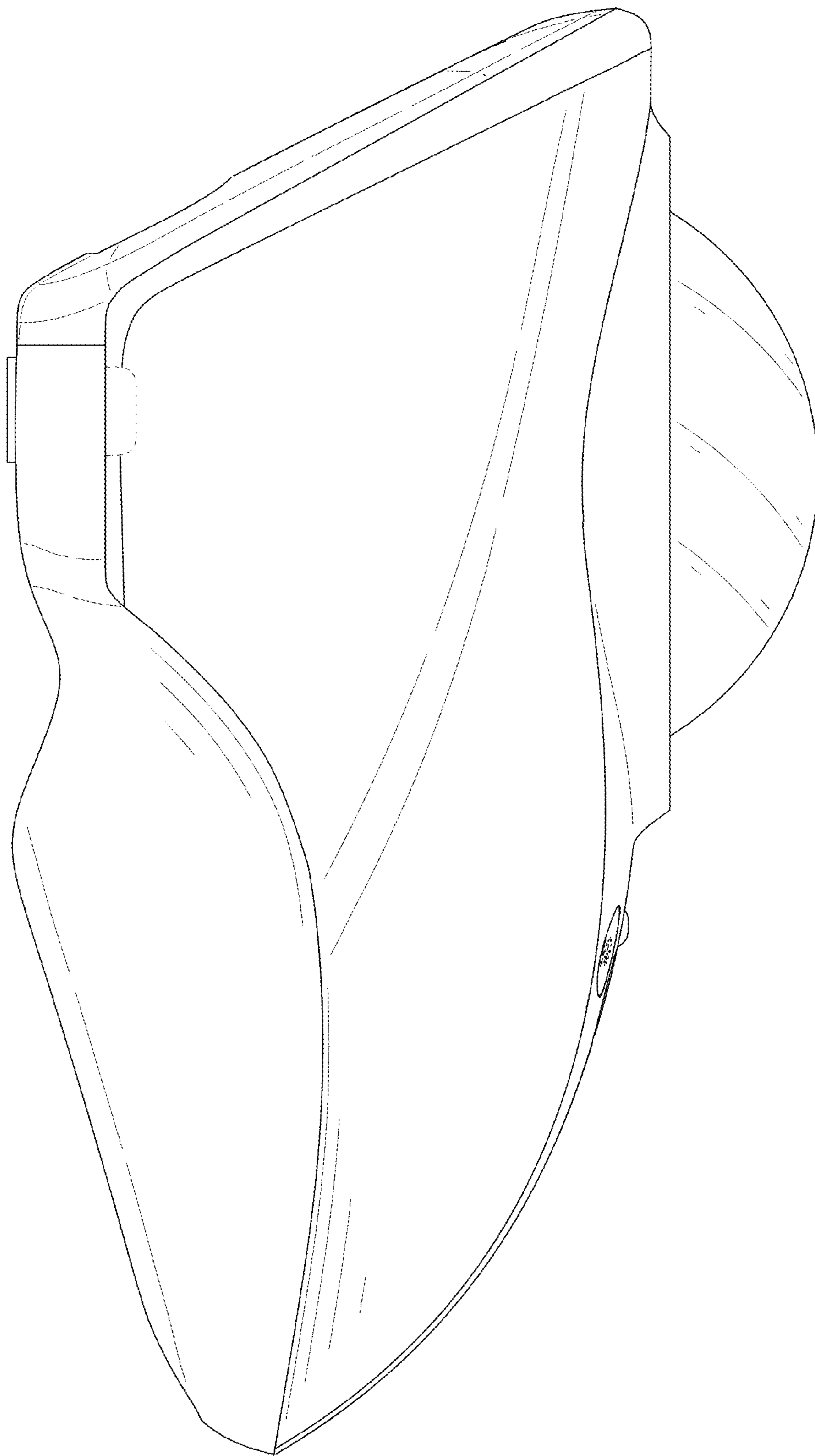

FIG. 5



FIG. 6

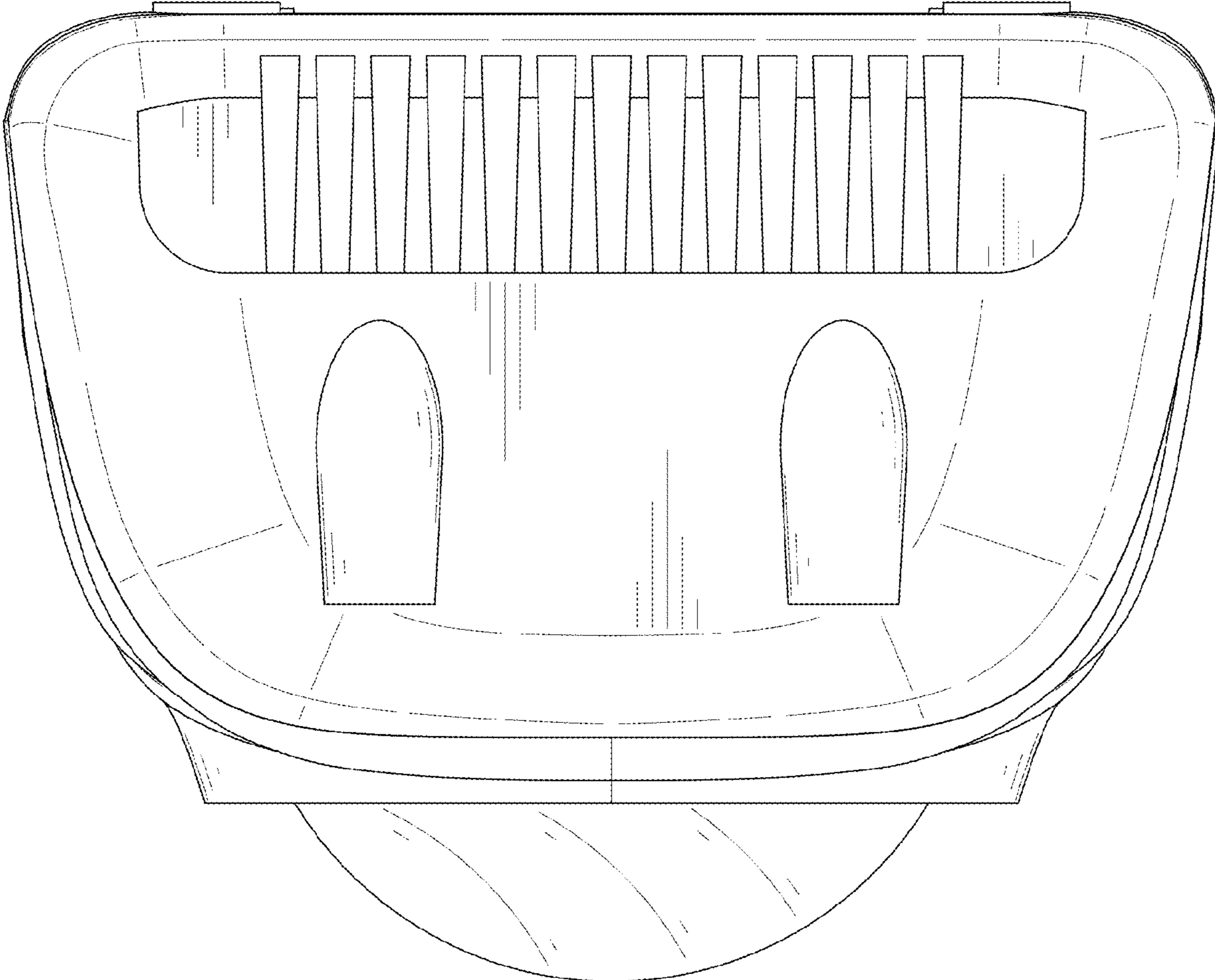

FIG. 7

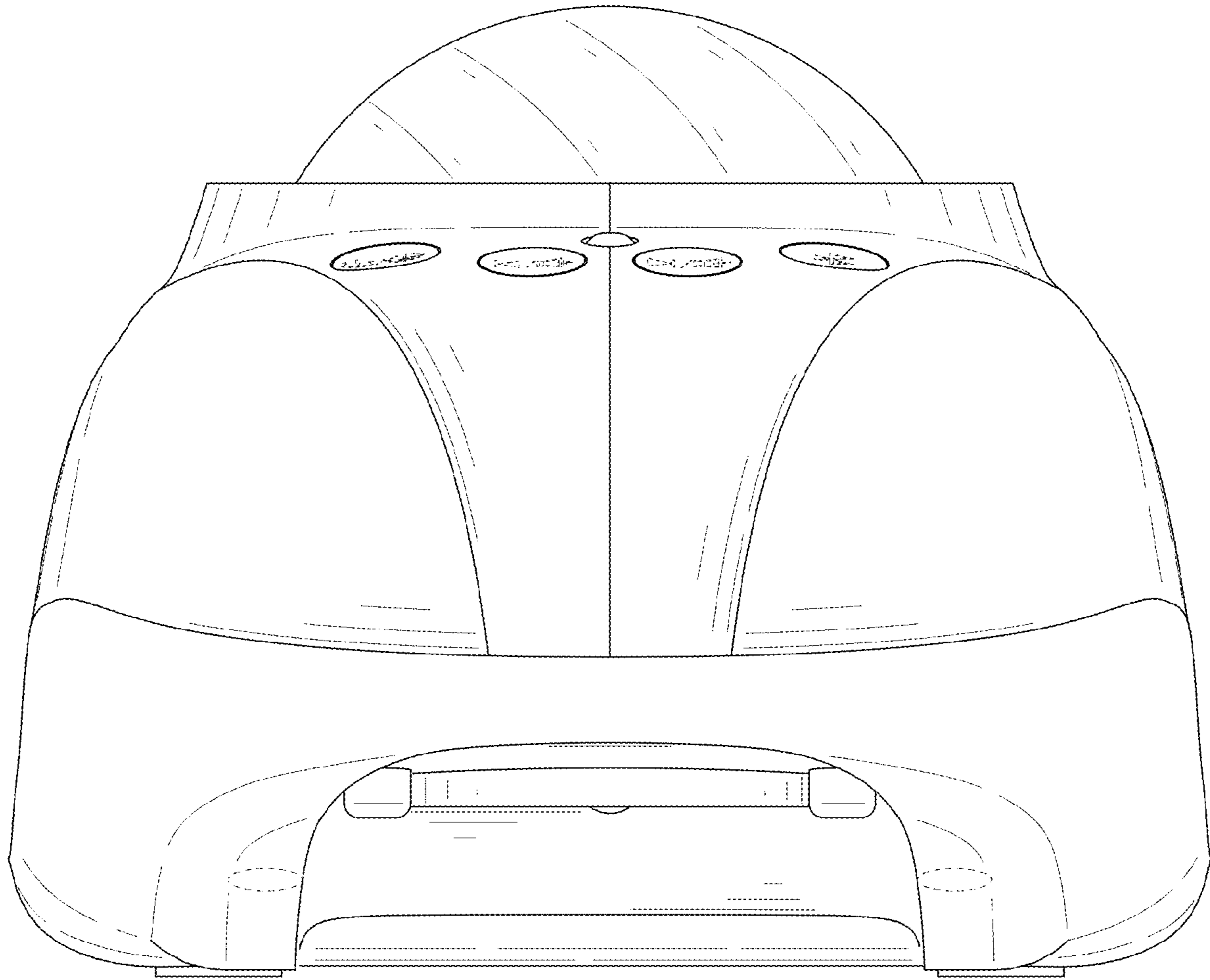

FIG. 8