



US00D946137S

(12) **United States Design Patent**
Puffer et al.

(10) **Patent No.:** **US D946,137 S**
(45) **Date of Patent:** **** Mar. 15, 2022**

- (54) **VENTILATION GRILLE**
- (71) Applicant: **Broan-NuTone LLC**, Hartford, WI (US)
- (72) Inventors: **Benjamin Puffer**, Hartford, WI (US);
Anup Nikam, Hartford, WI (US);
Kwame Appiahene-Agyei, Austin, TX (US);
David Jennings Lucas, Austin, TX (US)
- (73) Assignee: **Broan-NuTone LLC**, Hartford, WI (US)
- (**) Term: **15 Years**
- (21) Appl. No.: **29/689,759**
- (22) Filed: **May 1, 2019**
- (51) **LOC (13) Cl.** **23-04**
- (52) **U.S. Cl.**
USPC **D23/385**; D23/412
- (58) **Field of Classification Search**
USPC D23/314, 351, 353, 354, 364, 366,
D23/370-376, 378, 381, 383, 385, 388,
D23/393, 395, 411, 412; D26/59
CPC F24F 13/082; H04R 1/028
See application file for complete search history.

2,182,690 A 12/1939 Cole
D118,359 S 1/1940 Arenberg
D120,266 S 4/1940 Fischer
D120,772 S 5/1940 Arenberg
(Continued)

OTHER PUBLICATIONS

Broan QTX110SL Media Gallery, Broan QTX110SL Combination Fan, Light, Night-Light, 110 CFM, 0.9 Sones, Humidity Sensing, Ventingdirect.com, 1 page.

(Continued)

Primary Examiner — Sharon S Oum

(74) *Attorney, Agent, or Firm* — Barnes & Thornburg LLP

(57) **CLAIM**

The ornamental design for a ventilation grille, as shown and described.

DESCRIPTION

FIG. 1 is a bottom perspective view of a ventilation grille of the instant invention;
 FIG. 2 is a bottom view of the grille of FIG. 1;
 FIG. 3 is a top view of the grille of FIG. 1;
 FIG. 4 is a left side view of the grille of FIG. 1;
 FIG. 5 is a right side view of the grille of FIG. 1;
 FIG. 6 is a front side view of the grille of FIG. 1;
 FIG. 7 is a rear side view of the grille of FIG. 1;
 FIG. 8 is a bottom perspective view of another ventilation grille of the instant invention;
 FIG. 9 is a bottom view of the grille of FIG. 8;
 FIG. 10 is a top view of the grille of FIG. 8;
 FIG. 11 is a left side view of the grille of FIG. 8;
 FIG. 12 is a right side view of the grille of FIG. 8;
 FIG. 13 is a front side view of the grille of FIG. 8; and,
 FIG. 14 is a rear side view of the grille of FIG. 8.
 The broken lines illustrate portions of the ventilation grille that form no part of the claimed design.

- (56) **References Cited**
U.S. PATENT DOCUMENTS
- 1,030,028 A 6/1912 Stampahar et al.
- 1,395,833 A 11/1921 Kling et al.
- 1,532,635 A 4/1925 Osburn
- 1,713,101 A 5/1929 Starrett
- 1,886,841 A 11/1932 Searles
- 1,895,642 A 1/1933 Preble
- 1,941,450 A 1/1934 Sylvan
- 2,019,867 A 11/1935 Nelson
- 2,021,086 A 11/1935 Oskamp
- D107,399 S 12/1937 Broadwin
- 2,108,283 A 2/1938 Drew et al.
- D109,887 S 5/1938 Fordyce

1 Claim, 10 Drawing Sheets

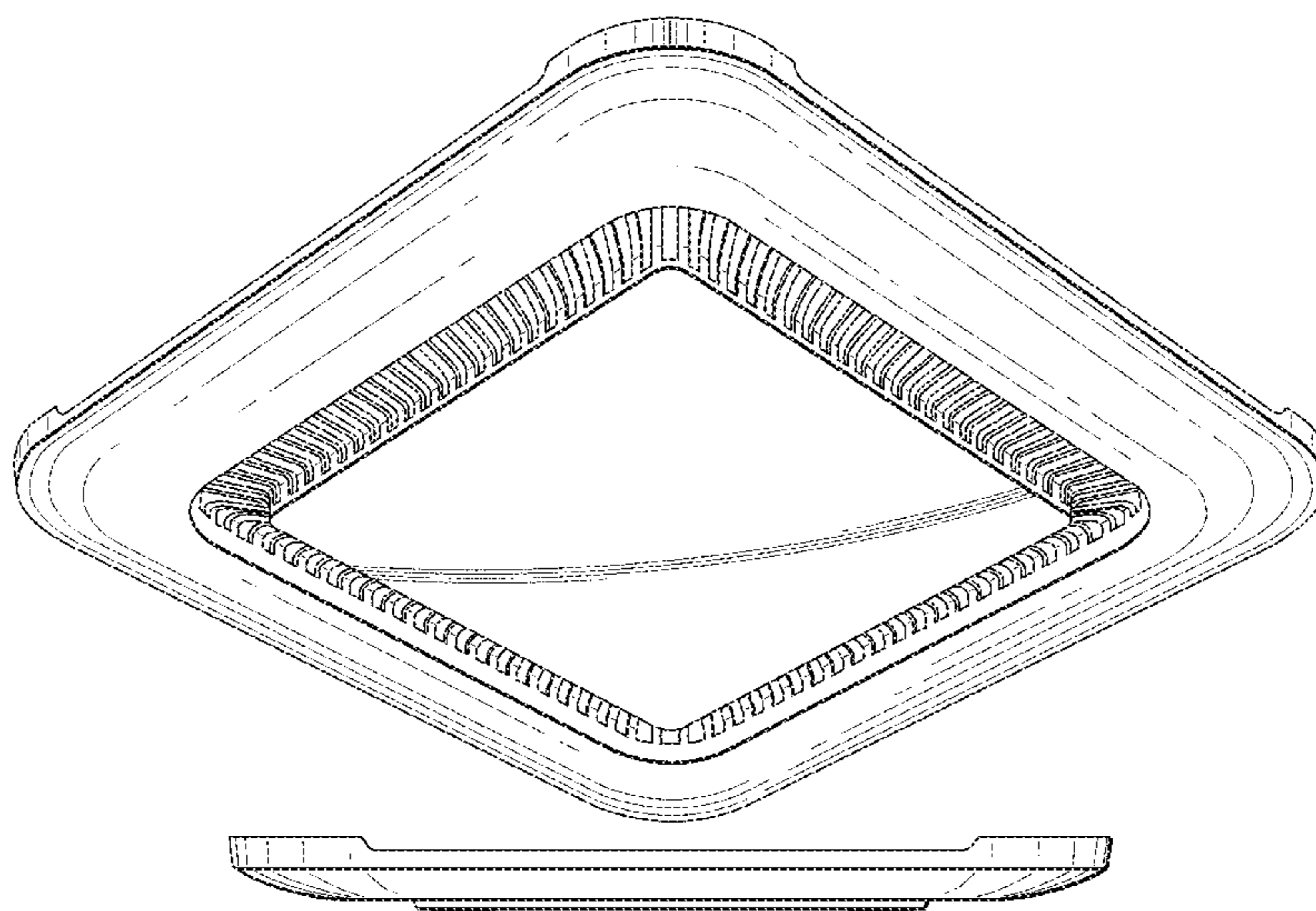

(56)

References Cited

U.S. PATENT DOCUMENTS

| | | | | | |
|-------------|---------|------------------|--------------|---------|---------------------|
| D120,773 S | 5/1940 | Arenberg | 3,788,207 A | 1/1974 | Doherty |
| 2,220,127 A | 11/1940 | Slyater | 3,861,894 A | 1/1975 | Marsh |
| 2,222,081 A | 11/1940 | Leigh | 3,875,678 A | 4/1975 | Vits |
| D126,128 S | 3/1941 | Eallman | 3,926,537 A | 12/1975 | Piper |
| 2,240,617 A | 5/1941 | Harrigan | 3,952,638 A | 4/1976 | Felter et al. |
| 2,278,581 A | 4/1942 | Dexter | D244,764 S | 6/1977 | Grubauer |
| D132,865 S | 6/1942 | Drollinger | D244,854 S | 6/1977 | Salamone |
| 2,325,657 A | 8/1943 | Burkness | 4,073,597 A | 2/1978 | Barnhart et al. |
| D153,313 S | 4/1949 | Phillips | 4,115,082 A | 9/1978 | Newell |
| 2,472,748 A | 6/1949 | Labus | 4,141,703 A | 2/1979 | Mulchi |
| 2,483,377 A | 9/1949 | Young | 4,203,332 A | 5/1980 | Corsetti |
| D157,014 S | 1/1950 | Walker | D256,047 S | 7/1980 | Wormington |
| 2,576,860 A | 11/1951 | Shapiro | D257,060 S | 9/1980 | Mann |
| D165,982 S | 2/1952 | Kennedy | D258,083 S | 1/1981 | Gammell |
| D166,324 S | 4/1952 | Kurth | 4,252,547 A | 2/1981 | Johnson |
| D171,505 S | 2/1954 | Krueger | D261,803 S | 11/1981 | Bohanon |
| 2,668,491 A | 2/1954 | Gerlitz | D262,457 S | 12/1981 | Swales |
| 2,673,514 A | 3/1954 | Hanks | 4,319,898 A | 3/1982 | Maierhofer |
| D173,120 S | 9/1954 | Levenhagen | 4,335,647 A | 6/1982 | Timmons |
| 2,689,906 A | 9/1954 | Corbett | 4,336,749 A | 6/1982 | Barnhart et al. |
| 2,697,163 A | 12/1954 | Spear | D267,828 S | 2/1983 | Cohen |
| 2,710,573 A | 6/1955 | Marker | D268,952 S | 5/1983 | Anderson |
| 2,780,981 A | 2/1957 | Miller | 4,382,440 A | 5/1983 | Kapp et al. |
| 2,790,375 A | 4/1957 | Broberg | 4,385,550 A | 5/1983 | Steiner et al. |
| 2,799,213 A | 7/1957 | Hansen | 4,385,911 A | 5/1983 | Popeil et al. |
| 2,800,069 A | 7/1957 | Smith | 4,406,216 A | 9/1983 | Hott et al. |
| D180,727 S | 8/1957 | Bourner | D271,984 S | 12/1983 | Nelson et al. |
| 2,811,094 A | 10/1957 | Auer | D275,988 S | 10/1984 | Walker |
| 2,824,429 A | 2/1958 | Zucker | D276,282 S | 11/1984 | Burg |
| 2,831,550 A | 4/1958 | Bub | D277,298 S | 1/1985 | Nelson |
| D183,117 S | 7/1958 | Coleman | D277,299 S | 1/1985 | Nelson |
| 2,875,678 A | 3/1959 | Shepherd | 4,510,851 A | 4/1985 | Sarnosky et al. |
| 2,911,900 A | 11/1959 | Rudy | D282,275 S | 1/1986 | Price |
| 2,939,377 A | 6/1960 | Stach | D282,972 S * | 3/1986 | Castor D26/59 |
| 2,963,956 A | 12/1960 | Hill | 4,594,940 A | 6/1986 | Wolbrink et al. |
| 2,987,258 A | 6/1961 | North | 4,610,705 A | 9/1986 | Sarnosky et al. |
| 2,996,972 A | 8/1961 | Johansson | D286,446 S | 10/1986 | Caroli et al. |
| 3,001,056 A | 9/1961 | Spear | 4,628,802 A | 12/1986 | Steiner et al. |
| 3,002,676 A | 10/1961 | Papsdorf | D287,888 S | 1/1987 | Castor et al. |
| D192,312 S | 2/1962 | Hart | D288,007 S | 1/1987 | Jonas et al. |
| 3,028,475 A | 4/1962 | Nash | D288,396 S | 2/1987 | Ritman |
| 3,045,579 A | 7/1962 | Jenn et al. | 4,681,024 A | 7/1987 | Ivey |
| D193,868 S | 10/1962 | Bloomfield | 4,722,266 A | 2/1988 | Deckert |
| 3,064,548 A | 11/1962 | Field | D295,675 S | 5/1988 | Demarest |
| 3,068,341 A | 12/1962 | Ortiz et al. | 4,754,697 A | 7/1988 | Asselbergs |
| 3,075,335 A | 1/1963 | Bandlow | 4,776,798 A | 10/1988 | Crawford |
| 3,097,287 A | 7/1963 | Knoll et al. | D300,777 S | 4/1989 | Bales et al. |
| 3,101,662 A | 8/1963 | Alldritt | D300,847 S | 4/1989 | Lin |
| D196,618 S | 10/1963 | Hammes | 4,862,334 A | 8/1989 | Ivey et al. |
| D199,045 S | 9/1964 | Everts | D303,436 S | 9/1989 | Clyde-Mason |
| 3,211,080 A | 10/1965 | Rader | 4,867,640 A | 9/1989 | Penlesky et al. |
| 3,212,425 A | 10/1965 | Hazen et al. | 4,991,496 A | 2/1991 | Kuno et al. |
| 3,215,828 A | 11/1965 | Bonvallet et al. | D315,790 S | 3/1991 | Koessler |
| 3,249,037 A | 5/1966 | Stalker | D322,667 S | 12/1991 | Fukuda et al. |
| 3,250,063 A | 5/1966 | Andrews | D323,209 S | 1/1992 | Fukumoto et al. |
| 3,276,597 A | 10/1966 | Mesek et al. | D323,554 S | 1/1992 | Hoyt et al. |
| 3,326,112 A | 6/1967 | Sadlow et al. | D325,434 S | 4/1992 | Dosmann |
| 3,332,334 A | 7/1967 | Melzer | D325,651 S | 4/1992 | Sonneman |
| 3,347,025 A | 10/1967 | Wiley | D328,650 S | 8/1992 | Jones |
| 3,391,689 A | 7/1968 | Roger | D330,585 S | 10/1992 | Saito et al. |
| 3,438,180 A | 4/1969 | Klouda | D331,458 S | 12/1992 | Saito et al. |
| 3,460,322 A | 8/1969 | Rivers et al. | D331,638 S | 12/1992 | Vamberszky et al. |
| 3,572,234 A | 3/1971 | Schoenthaler | D334,053 S | 3/1993 | Cook |
| 3,577,710 A | 5/1971 | Feldman | 5,197,920 A | 3/1993 | Ganse |
| 3,606,593 A | 9/1971 | Steiner | D334,977 S | 4/1993 | Avari |
| 3,630,007 A | 12/1971 | Neumann | D336,895 S | 6/1993 | Rogov |
| 3,636,306 A | 1/1972 | Bumpus | D338,954 S | 8/1993 | Brock |
| 3,665,838 A | 5/1972 | Shepherd | D340,109 S | 10/1993 | Julien |
| 3,692,977 A | 9/1972 | Duhamel et al. | D341,442 S | 11/1993 | Shapiro |
| 3,698,833 A | 10/1972 | Cann et al. | 5,319,942 A | 6/1994 | Paustian et al. |
| 3,732,030 A | 5/1973 | Mullings | D349,778 S | 8/1994 | Johnson et al. |
| 3,743,439 A | 7/1973 | Cann | D350,191 S | 8/1994 | Tsuji |
| D229,181 S | 11/1973 | Bledsoe | 5,333,830 A | 8/1994 | Millen |
| 3,777,650 A | 12/1973 | Wenig | D350,409 S | 9/1994 | Johnson et al. |
| 3,785,271 A | 1/1974 | Joy | D352,564 S | 11/1994 | Marischen |
| | | | D357,732 S | 4/1995 | Spechts et al. |
| | | | D361,375 S | 8/1995 | Gallagher et al. |
| | | | D362,059 S | 9/1995 | Wojcik |
| | | | D366,521 S | 1/1996 | Wijaranakula |

(56)

References Cited

U.S. PATENT DOCUMENTS

D366,522 S 1/1996 Lagace et al.
 D367,924 S 3/1996 Patel et al.
 D372,767 S 8/1996 Borges
 D372,775 S 8/1996 Schuler
 D374,927 S 10/1996 Chabot
 D375,350 S 11/1996 Patel et al.
 D376,214 S 12/1996 Pinchuk
 D376,639 S 12/1996 Moore
 D376,842 S 12/1996 Franklin et al.
 D377,535 S 1/1997 Shulman
 5,601,485 A 2/1997 Gigola
 D378,698 S 4/1997 Ukai et al.
 5,632,334 A 5/1997 Grinbergs et al.
 D382,549 S 8/1997 Yoshimoto
 D386,186 S 11/1997 Schnetzer et al.
 D386,209 S 11/1997 Firestone et al.
 D387,859 S 12/1997 Ukai et al.
 D388,353 S 12/1997 Desborough et al.
 D393,708 S 4/1998 Assadi
 D395,494 S 6/1998 Becker
 D396,275 S 7/1998 Pearson
 D398,417 S 9/1998 Fritzsche et al.
 5,820,247 A 10/1998 Schuler
 D401,682 S 11/1998 Galeazzi et al.
 D403,442 S 12/1998 Joss
 D403,787 S 1/1999 Van Belle
 D404,508 S 1/1999 Marischen
 D405,207 S 2/1999 Mora
 D407,473 S 3/1999 Wimbock
 D407,521 S 3/1999 Crosby
 5,879,232 A 3/1999 Luter et al.
 D409,449 S 5/1999 Cornelissen
 5,918,972 A 7/1999 Van Belle
 D412,566 S 8/1999 Taras et al.
 D414,253 S 9/1999 Kobayashi et al.
 5,971,847 A 10/1999 Webb
 D416,315 S 11/1999 Nanjo
 D416,349 S 11/1999 Pahl
 D417,307 S 11/1999 Pahl
 D418,909 S 1/2000 Mockett
 D420,121 S 2/2000 Felix-Flender
 6,027,406 A 2/2000 Yazici
 D424,672 S 5/2000 Nanjo
 D425,974 S 5/2000 Esty et al.
 D426,124 S 6/2000 Kassalen et al.
 D426,292 S 6/2000 Nanjo
 D426,657 S 6/2000 Joss
 D427,009 S 6/2000 Iyengar et al.
 D427,303 S 6/2000 Brown
 D428,645 S 7/2000 Rossman et al.
 6,227,962 B1 5/2001 Orendorff
 6,261,175 B1 7/2001 Larson et al.
 6,464,579 B1 10/2002 Salazar
 6,488,579 B2 12/2002 Larson et al.
 6,503,060 B1 1/2003 Kamada et al.
 6,537,146 B1 3/2003 Haynes
 6,651,454 B1 11/2003 Spiegel
 6,653,566 B2 11/2003 Petak et al.
 6,723,428 B1 4/2004 Foss et al.
 6,750,760 B2 6/2004 Albritton et al.
 6,889,948 B2 5/2005 Melancon et al.
 6,979,169 B2 12/2005 Penlesky et al.
 D535,431 S * 1/2007 Roland D26/118
 7,203,416 B2 4/2007 Craw et al.
 D557,781 S * 12/2007 Kim D23/351
 7,328,478 B2 2/2008 Jenkins
 D570,983 S * 6/2008 Deng D23/372
 D575,386 S * 8/2008 Jacak D23/371
 D586,456 S * 2/2009 Guthrie D23/412
 7,537,647 B2 5/2009 Adair et al.
 7,581,717 B1 9/2009 Thurlkill
 7,596,960 B2 10/2009 Bae
 D618,782 S 6/2010 Zakula et al.
 D626,644 S 11/2010 Jacak et al.
 7,850,513 B1 12/2010 Parker et al.

D635,238 S 3/2011 Zakula et al.
 D653,323 S 1/2012 Jacak et al.
 D654,998 S 2/2012 Zakula et al.
 D655,403 S 3/2012 Zakula et al.
 D665,225 S 8/2012 Zakula et al.
 8,256,241 B2 9/2012 Ikeda et al.
 D678,995 S 3/2013 Hoshino et al.
 D701,952 S 4/2014 Hoshino et al.
 D706,916 S 6/2014 Penlesky et al.
 8,864,447 B1 10/2014 Humphrey
 9,022,846 B1 5/2015 Tom
 9,028,212 B1 5/2015 Tom
 9,103,104 B1 8/2015 Tom
 9,131,814 B2 9/2015 Nakamura et al.
 9,182,138 B2 11/2015 Foreman et al.
 9,188,132 B1 11/2015 Tom
 9,212,668 B2 12/2015 Deng et al.
 9,303,859 B2 4/2016 Horng et al.
 9,303,888 B2 4/2016 Karst et al.
 D759,800 S 6/2016 Adrian et al.
 D778,424 S 2/2017 Jonas et al.
 D778,425 S 2/2017 Jonas et al.
 D779,050 S 2/2017 Jonas et al.
 D784,511 S 4/2017 Jonas et al.
 D784,512 S 4/2017 Jonas et al.
 D799,677 S 10/2017 Jonas et al.
 D799,678 S 10/2017 Jonas et al.
 D799,679 S 10/2017 Jonas et al.
 D800,294 S 10/2017 Jonas et al.
 D800,295 S 10/2017 Jonas et al.
 D800,892 S 10/2017 Jonas et al.
 D815,724 S 4/2018 Jonas et al.
 D816,206 S 4/2018 Jonas et al.
 D822,821 S 7/2018 Jonas et al.
 D837,966 S 1/2019 Adrian et al.
 D842,449 S 3/2019 Chang et al.
 D844,765 S * 4/2019 Zhang D23/364
 D857,872 S * 8/2019 Shimada D23/371
 D879,284 S * 3/2020 Puffer D23/385
 D892,296 S * 8/2020 Puffer D23/385
 2013/0088855 A1 4/2013 Ye
 2015/0117034 A1 4/2015 Horng
 2015/0125292 A1 5/2015 Karst
 2016/0069561 A1 3/2016 Jonas

OTHER PUBLICATIONS

Emerson Environment Products, Whole House Fan and Shutter System Owners Manual, Dec. 1982.
 Photographs of Panasonic Ventilating Fan, Model FV-11, VHL1, available prior to Jan. 2, 2008, 3 pages.
 Spartan Electric Company, Direct Drive Whole House Fans Publication, available prior to Jan. 2, 2008.
 “Whirlpool 30 and 36 Range Hood Models UXT3030AY/UXT3036AY.” Installation Instructions and Use & Care Guide, [online], Retrieved from the Internet: <http://www.whirlpool.ca/digitalassests/UXT3030AYB/US%20and%20Care_EN.pdf>, 2011. 28 pages.
 “Maytag 30 in. Non-Vented Range Hood in Stainless Steel,” Model# UXT4030AYS, Home Depot, [online], Retrieved From the Internet on Sep. 23, 2013: <http://www.homedepot.com/p/Maytag-30-in-Non-Vented-Range-Hood-in-Stainless-Steel-UXT_4030AYS/202832999#customer_reviews>, 5 pages.
 “Finnleo Steam Sauna Ventilation Wood Grill,” online, Retrieved from the Internet: <<https://www.tineye.com/search/8ff8db465e46f58bcad482160583c-b539dc23fa4/>>, Jun. 6, 2012.
 Napoleon Prestige Pro 450-Natural Gas, image post date Apr. 5, 2014, site visited May 15, 2016, [online], <<http://web.archive.org/web/20140405111728/http://www.bbqworld.co.uk/n- napoleon/napoleon-prestige-pro-450-natural-gas.asp>>.
 “Ultra Green Series,” [online], Retrieved from Internet: <<http://web.archive.org/web/20140416053348/http://www.boran.com/products/filter/ultra-406c-abf1-ed72241eb706>>, Apr. 16, 2014.
 “Airvent 435103 Kitchen Extractor Fan,” [online], Retrieved from Internet: <<https://www.amazon.co.uk/Airvent-435103-Kitchen->

(56)

References Cited

OTHER PUBLICATIONS

Extractor-1- 50mm/dp/B0085TQ75U/ref=pd.sub.--cp.sub.--107.sub.-
3?ie=UTF8&refRID=1MXRP1-Q1QR5H6NZ1MR7C., May 14, 2014.
Air Vent Grille Cover, image post date Nov. 9, 2014, site visited
May 14, 2016, [online], <[https://www.tineye.com/search/
232b8f674998285163e7a3de47a03ed0ef9b1dc- 6/](https://www.tineye.com/search/232b8f674998285163e7a3de47a03ed0ef9b1dc-6/)>.
“Manrose FF100P Bathroom Fan,” [online], Retrieved from Inter-
net: <[https://www.tineye.com/
search63988ff8b950dad9cb1aaec51119050bdd00cf2- 1/?plug-
inver=>](https://www.tineye.com/search63988ff8b950dad9cb1aaec51119050bdd00cf2-1/?pluginver=>)>, Dec. 12, 2014.
NuTone 791LEDNT Fan/Light.

* cited by examiner

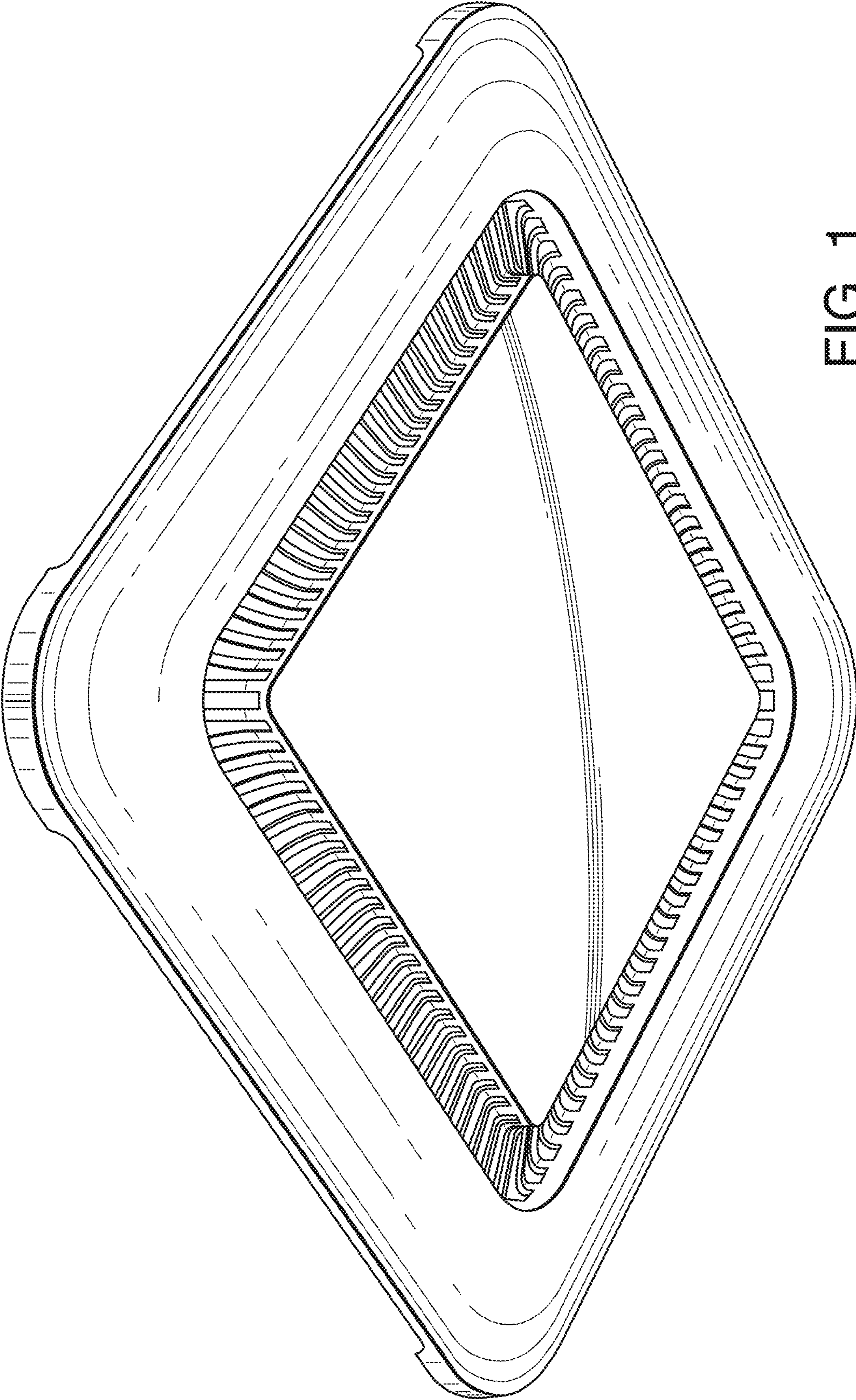

FIG. 1

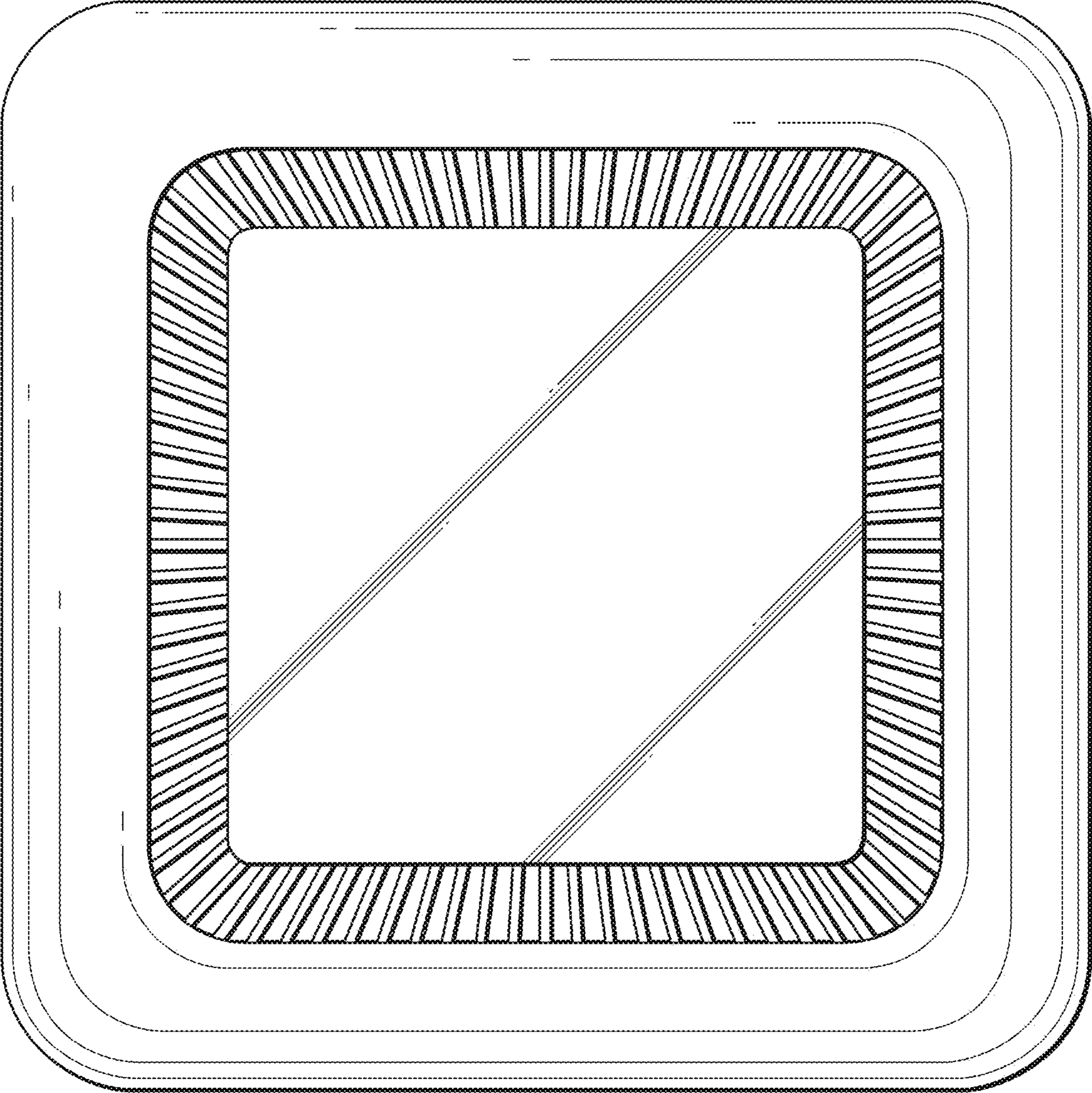

FIG. 2

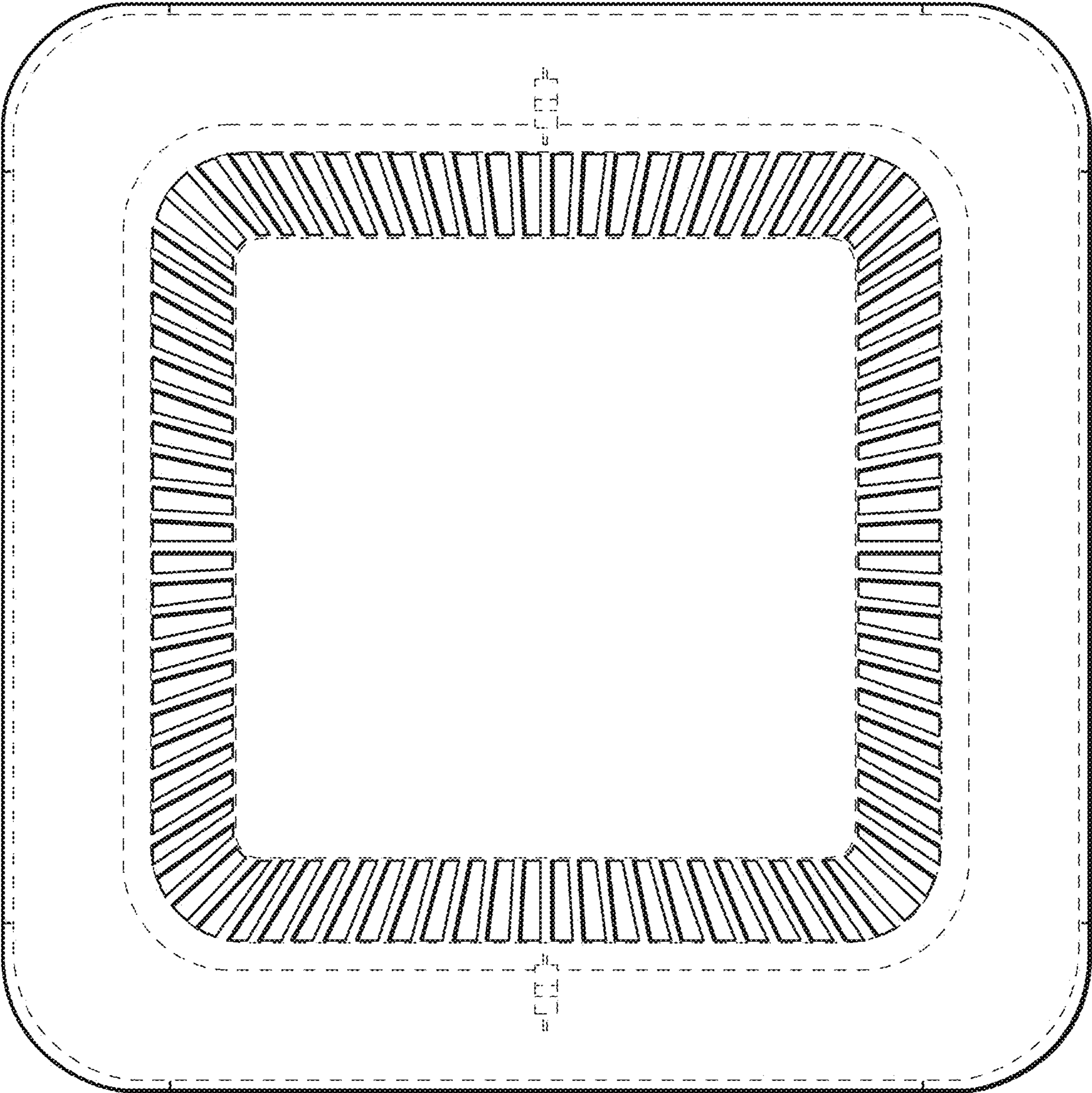

FIG. 3

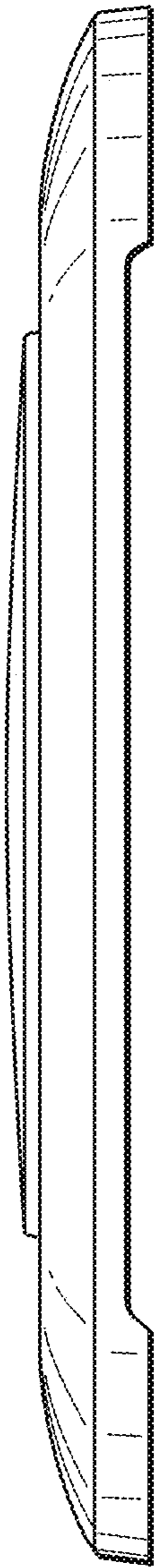

FIG. 4

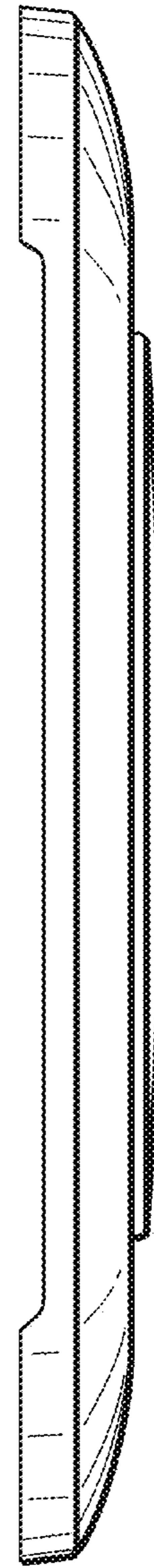

FIG. 5

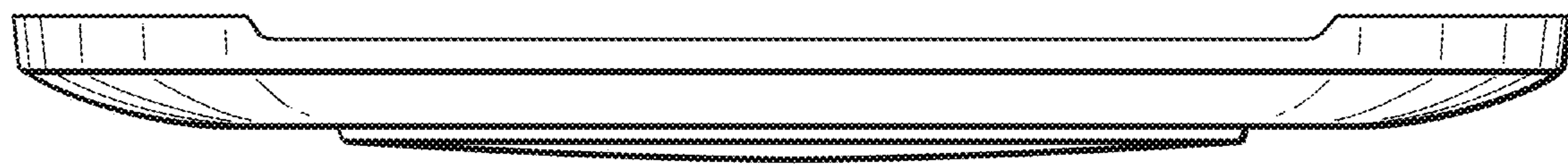

FIG. 6

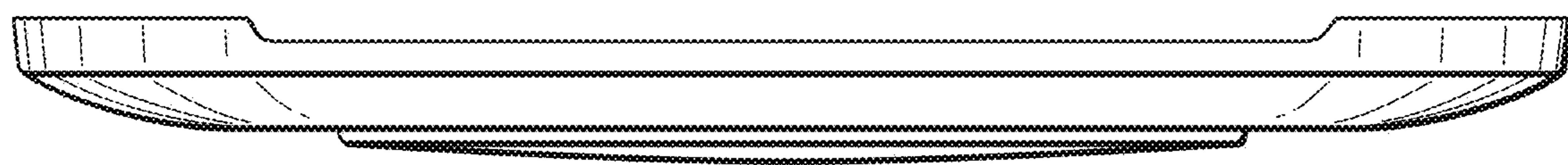

FIG. 7

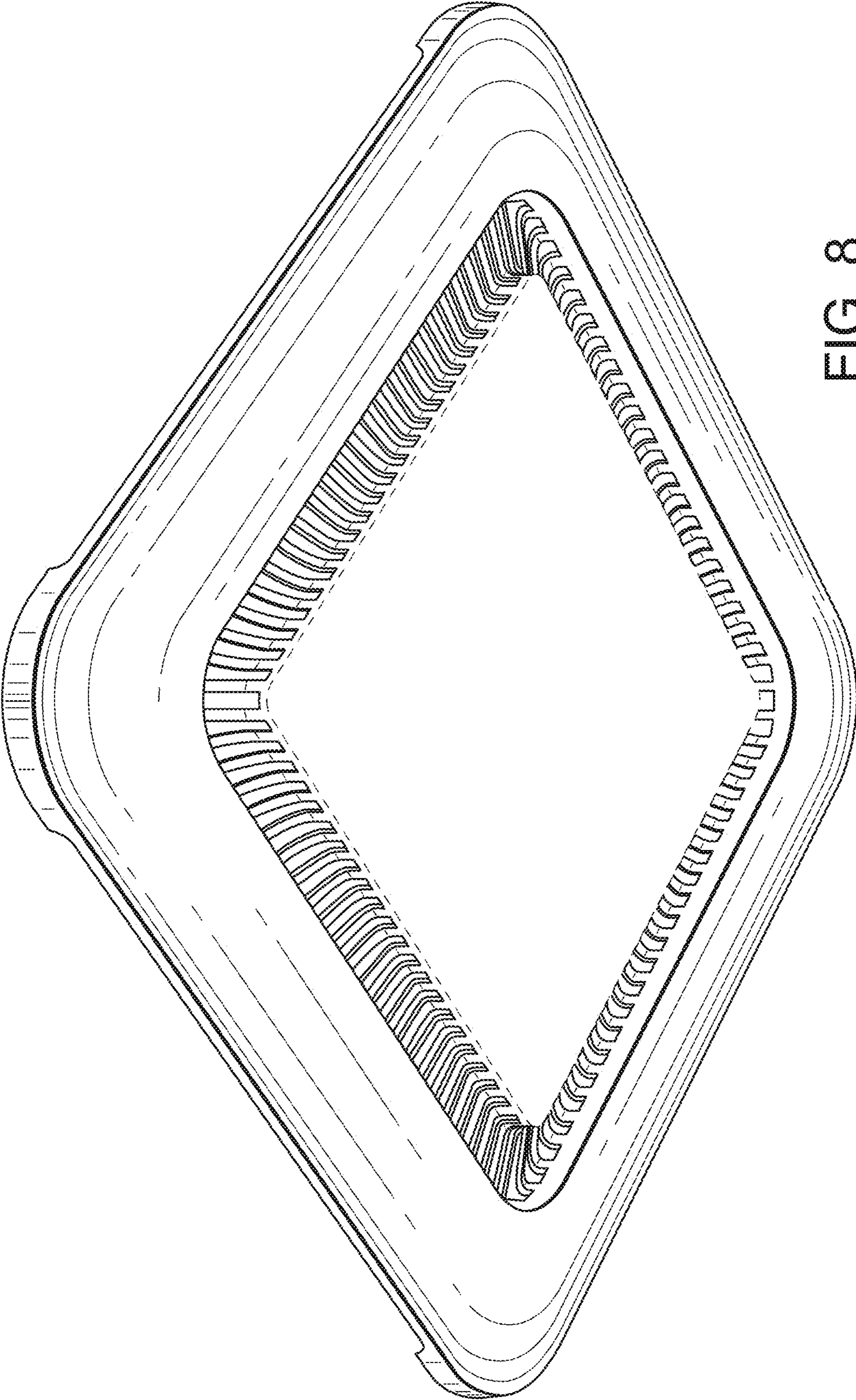

FIG. 8

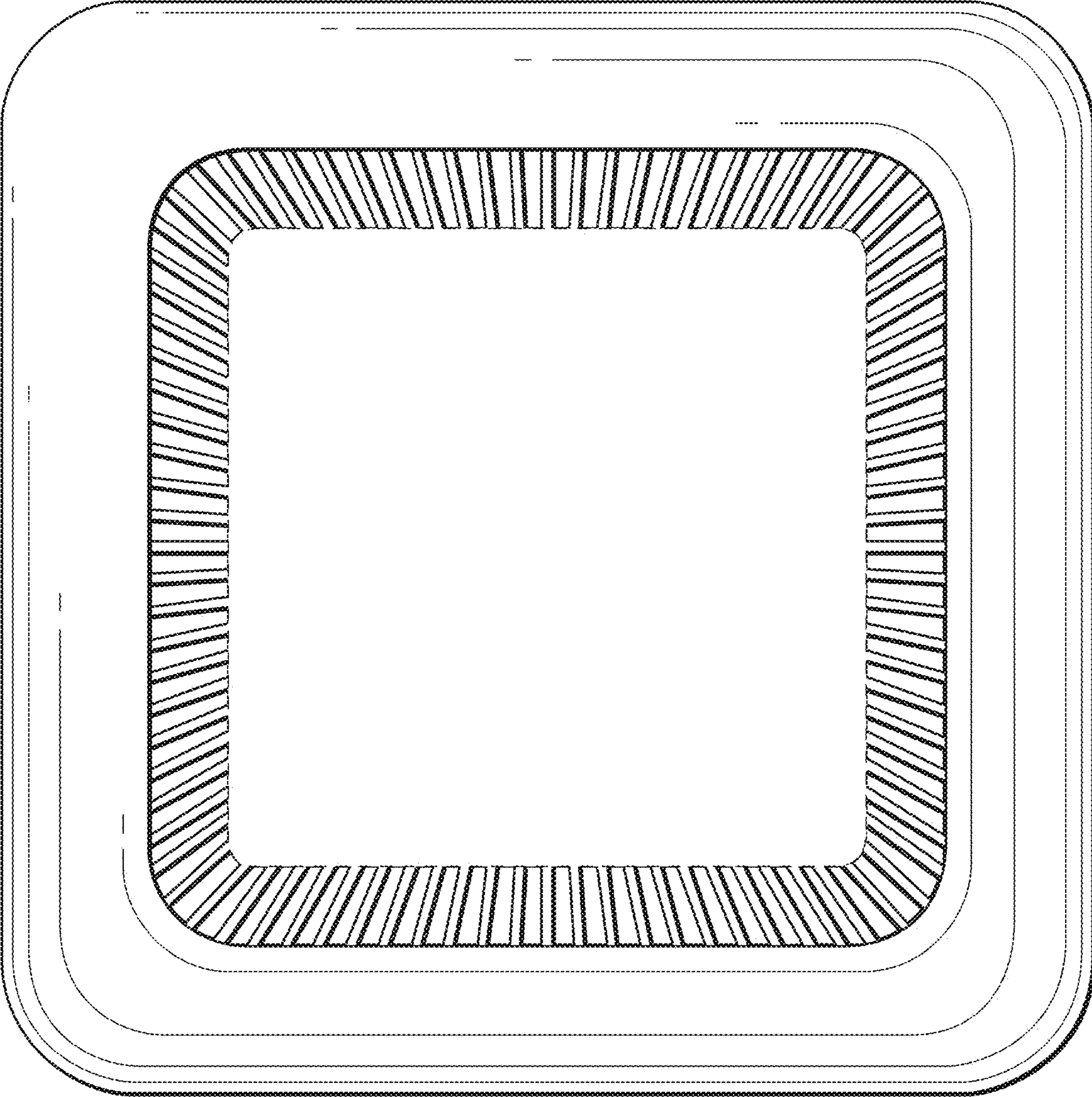

FIG. 9

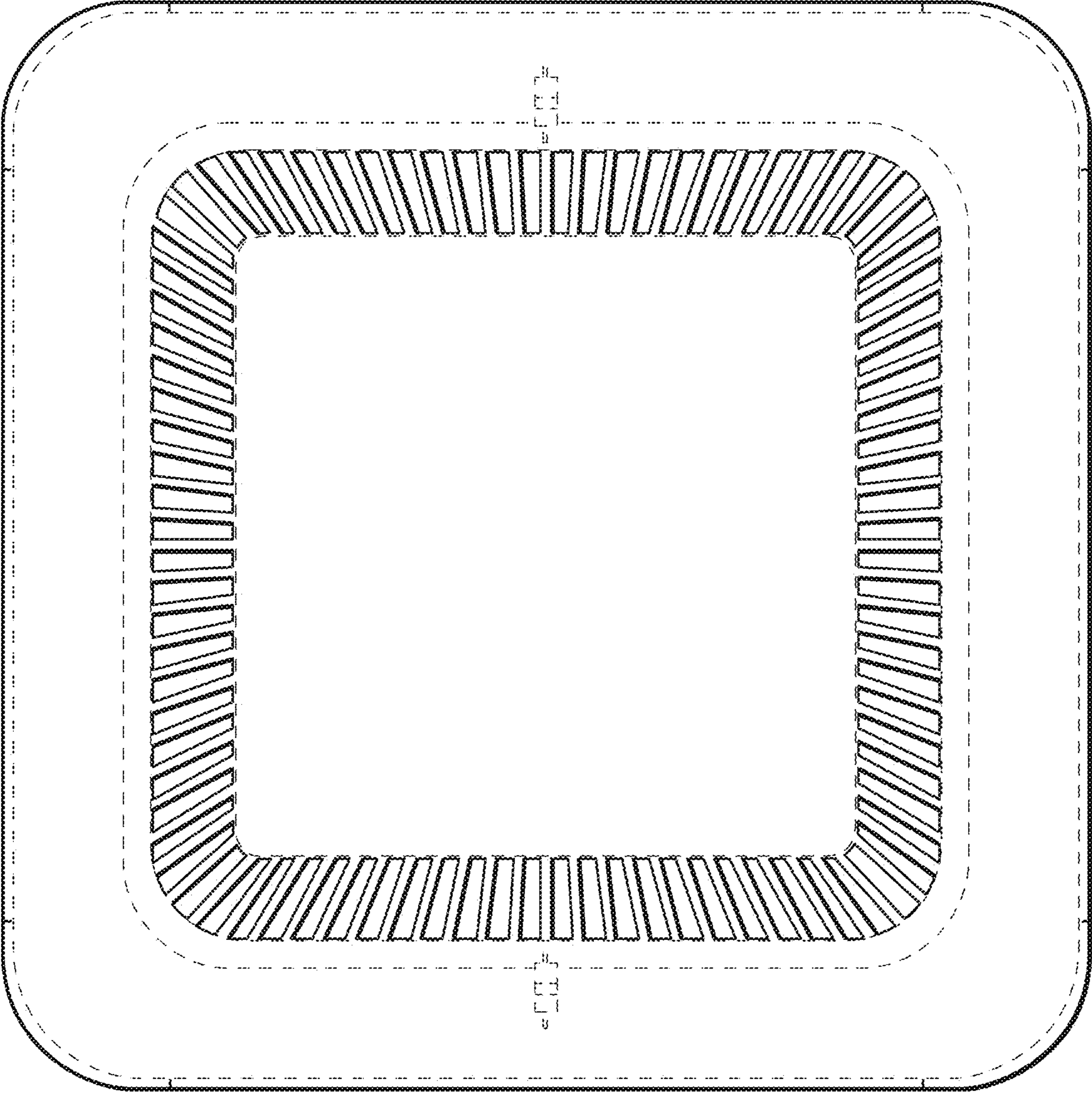

FIG. 10

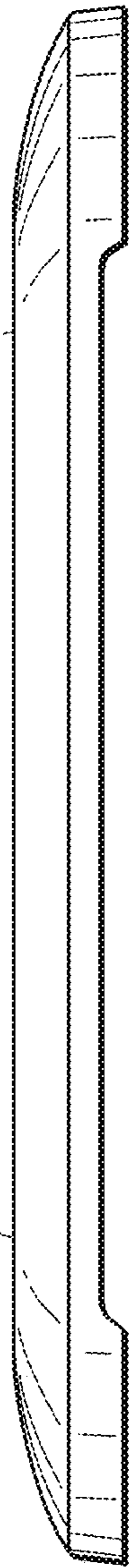

FIG. 11

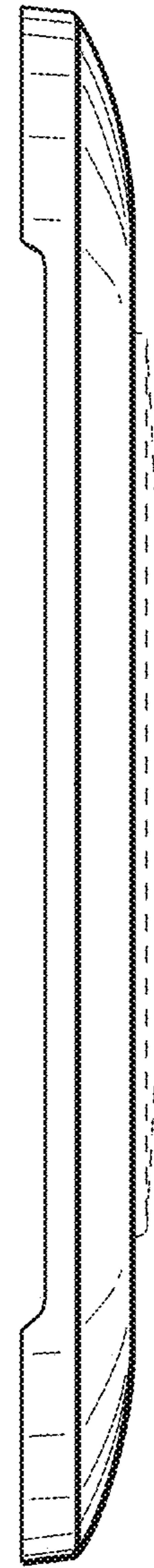

FIG. 12

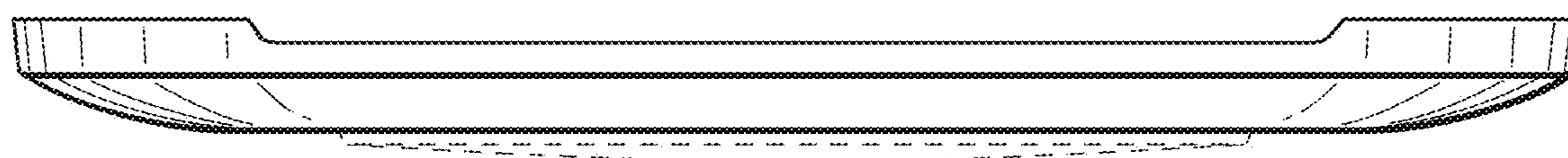

FIG. 13

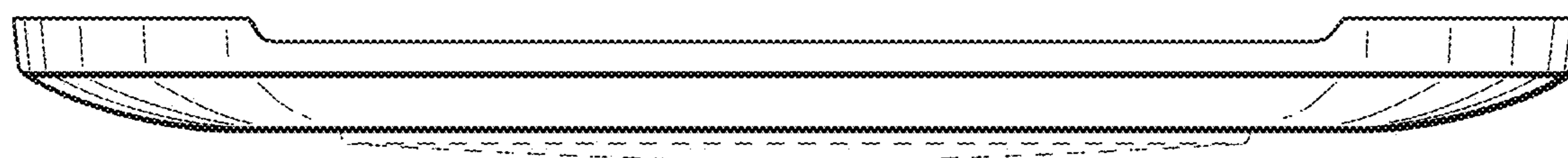

FIG. 14