



US00D946095S

(12) **United States Design Patent**  
**Hunt et al.**

(10) **Patent No.:** **US D946,095 S**  
(45) **Date of Patent:** **\*\* Mar. 15, 2022**

(54) **NATURAL SURFACE BALANCE AND MOVEMENT STANDING MAT**

(71) Applicant: **The Wild Gym Company LLC**,  
Niwot, CO (US)

(72) Inventors: **David Hunt**, Coram, MT (US); **Daniel Vinson**, Lafayette, CO (US)

(73) Assignee: **THE WILD GYM COMPANY LLC**,  
Louisville, CO (US)

(\*\*) Term: **15 Years**

(21) Appl. No.: **29/757,565**

(22) Filed: **Nov. 6, 2020**

(51) **LOC (13) Cl.** ..... **21-02**

(52) **U.S. Cl.**  
USPC ..... **D21/686**

(58) **Field of Classification Search**  
USPC ..... D21/662, 690, 686, 685, 671, 688, 668,  
D21/673, 682, 677, 665, 796, 791, 334;  
D24/192, 212, 213, 214  
See application file for complete search history.

(56) **References Cited**

**U.S. PATENT DOCUMENTS**

D411,304 S *	6/1999	Yang	.....	D24/212
D414,874 S *	10/1999	Edens	.....	D24/212
D888,852 S *	6/2020	Fu	.....	D21/686
D890,868 S *	7/2020	Zhao	.....	D21/686
D910,125 S *	2/2021	Liu	.....	D21/688
D916,218 S *	4/2021	Lu	.....	D21/688
D925,667 S *	7/2021	Jones	.....	D21/680
11,097,152 B2 *	8/2021	Lu	.....	A63B 21/0004
11,172,867 B2 *	11/2021	Chang	.....	A61B 5/1077
11,173,344 B2 *	11/2021	Stehlik	.....	A63B 21/00178

**OTHER PUBLICATIONS**

Licloud, announced 2018[online], [site visited Nov. 19, 2021]. Available on internet, URL:<https://www.amazon.com/Licloud-Anti-fatigue-Balance-Standing-Accessory/dp/B07DWSKLMY/ref> (Year: 2018).\*

StrongTek, announced 2020[online], [site visited Nov. 19, 2021]. Available on internet, URL:<https://www.amazon.com/StrongTek-Standing-Accessories-Balancing-Strength/dp/B08KTVYXD5/ref> (Year: 2020).\*

\* cited by examiner

*Primary Examiner* — Khawaja Anwar

*Assistant Examiner* — Julice Seung Eun Oum

(74) *Attorney, Agent, or Firm* — Martensen IP; Michael C. Martensen

(57) **CLAIM**

The ornamental design for a natural surface balance and movement standing mat, as shown and described.

**DESCRIPTION**

FIG. 1 is a front, top perspective view of one embodiment of a natural surface balance and movement standing mat showing our new design;

FIG. 2 is a bottom perspective view thereof;

FIG. 3 is top view thereof;

FIG. 4 is a bottom view thereof;

FIG. 5 is a right side view thereof;

FIG. 6 is a left side view thereof;

FIG. 7 is a front view thereof;

FIG. 8 is a back view thereof;

FIG. 9 is a front, top perspective exploded view of components thereof;

FIG. 10 is a bottom perspective exploded view of components thereof;

FIG. 11 is a right side exploded view of components thereof;

FIG. 12 is a left side exploded view of components thereof;

FIG. 13 is a front exploded view of components thereof; and,

FIG. 14 is a back exploded view of components thereof.

The broken lines shown in the drawings depict portions of the natural surface balance and movement standing mat that form no part of the claimed design.

**1 Claim, 11 Drawing Sheets**

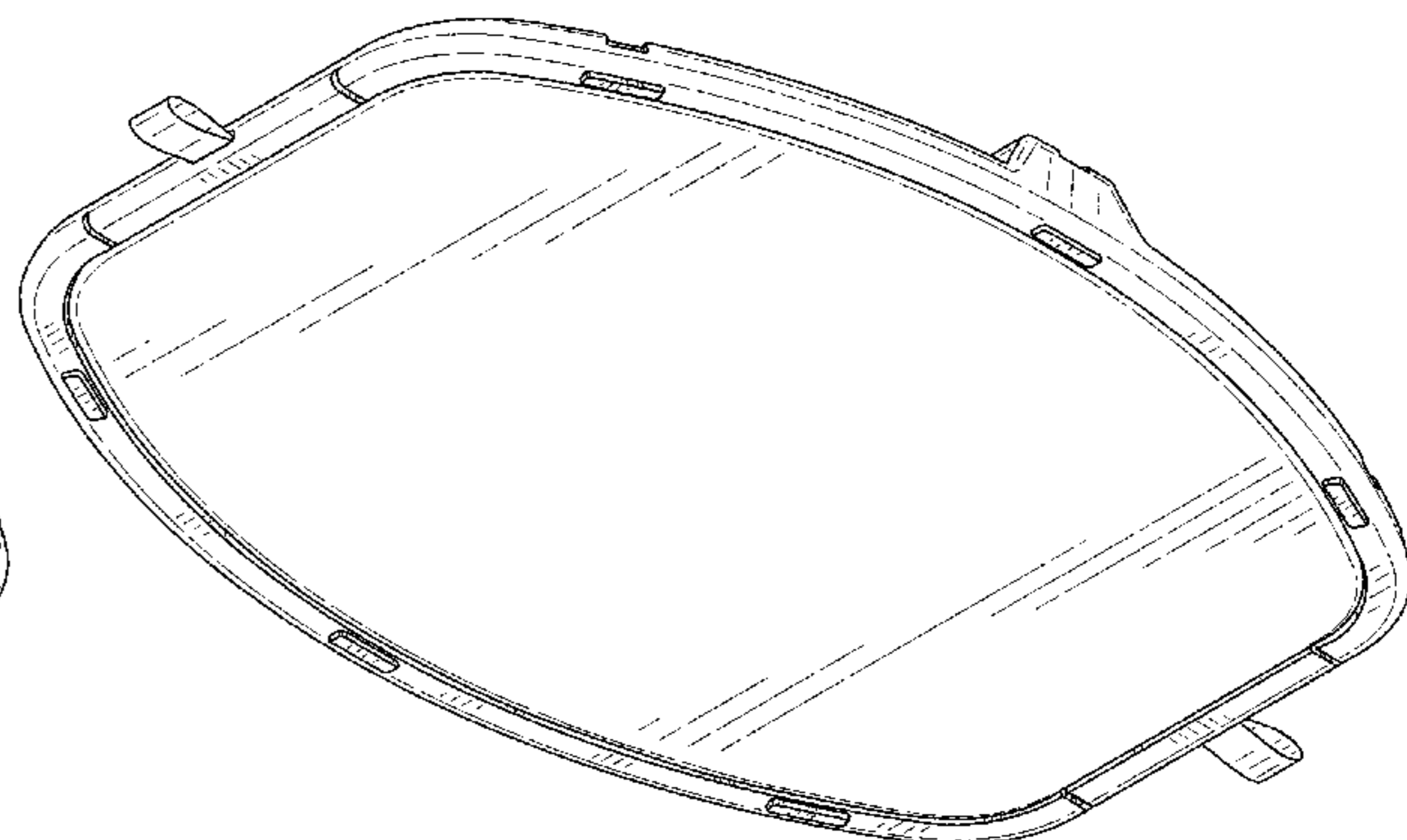
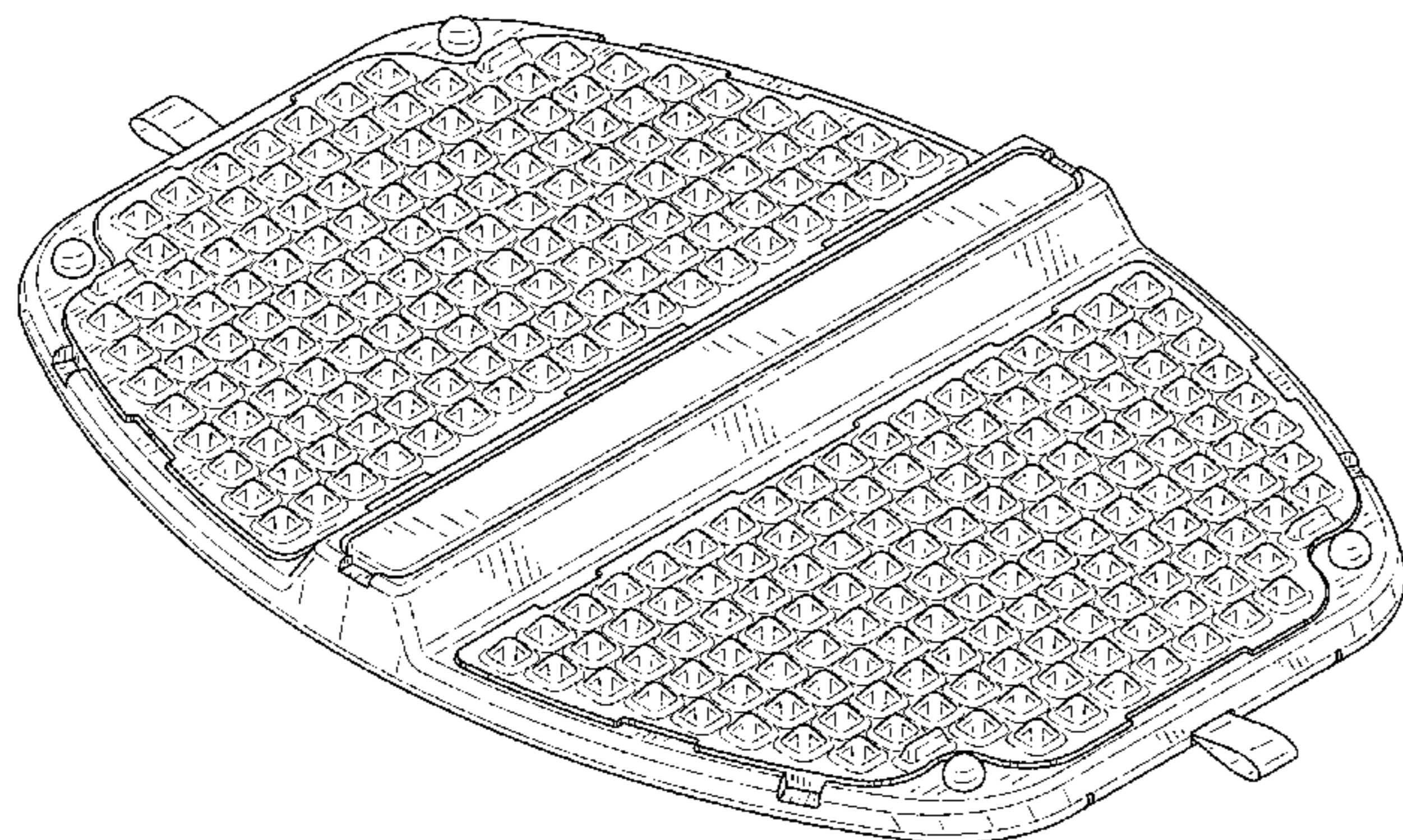





FIG.1

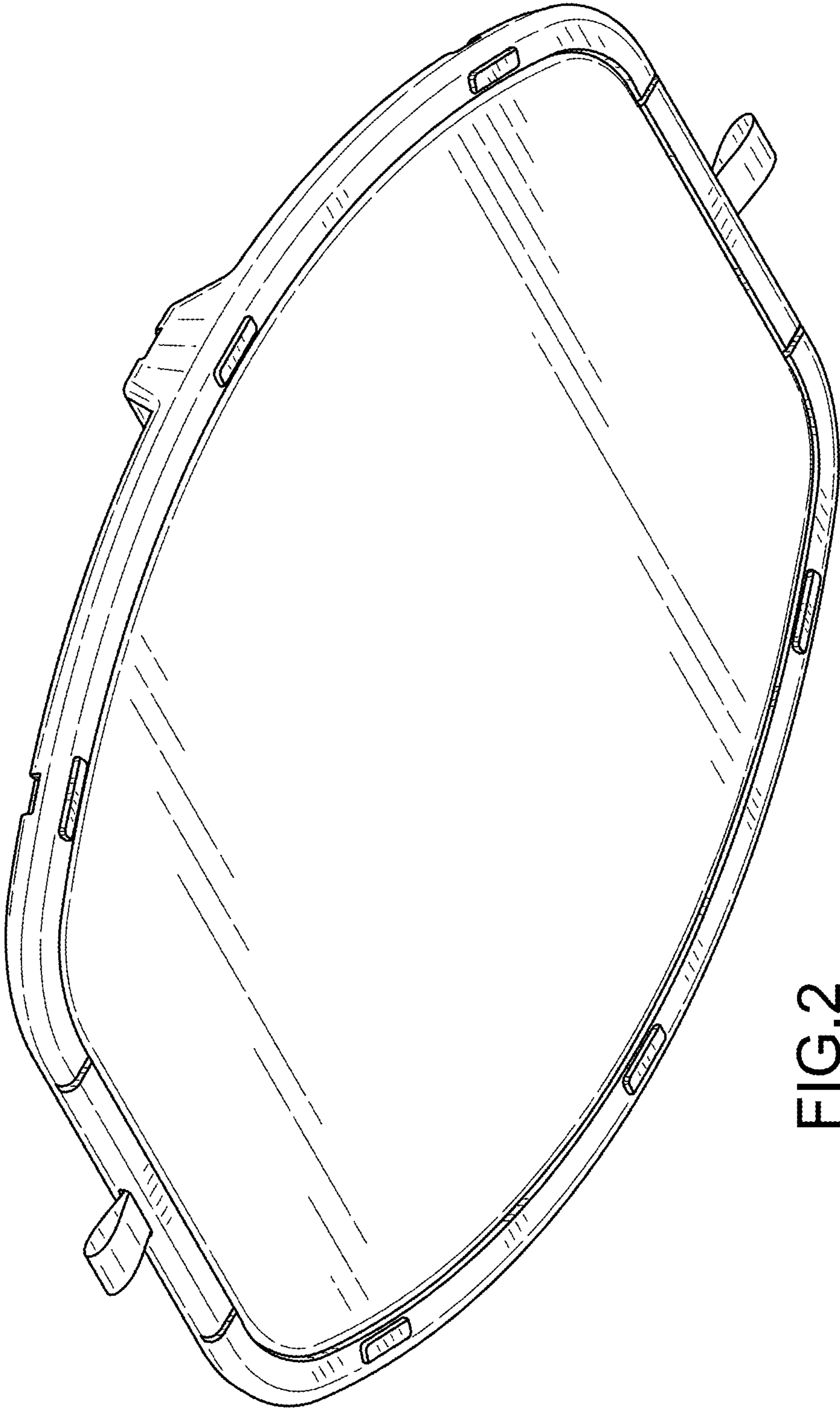

FIG. 2



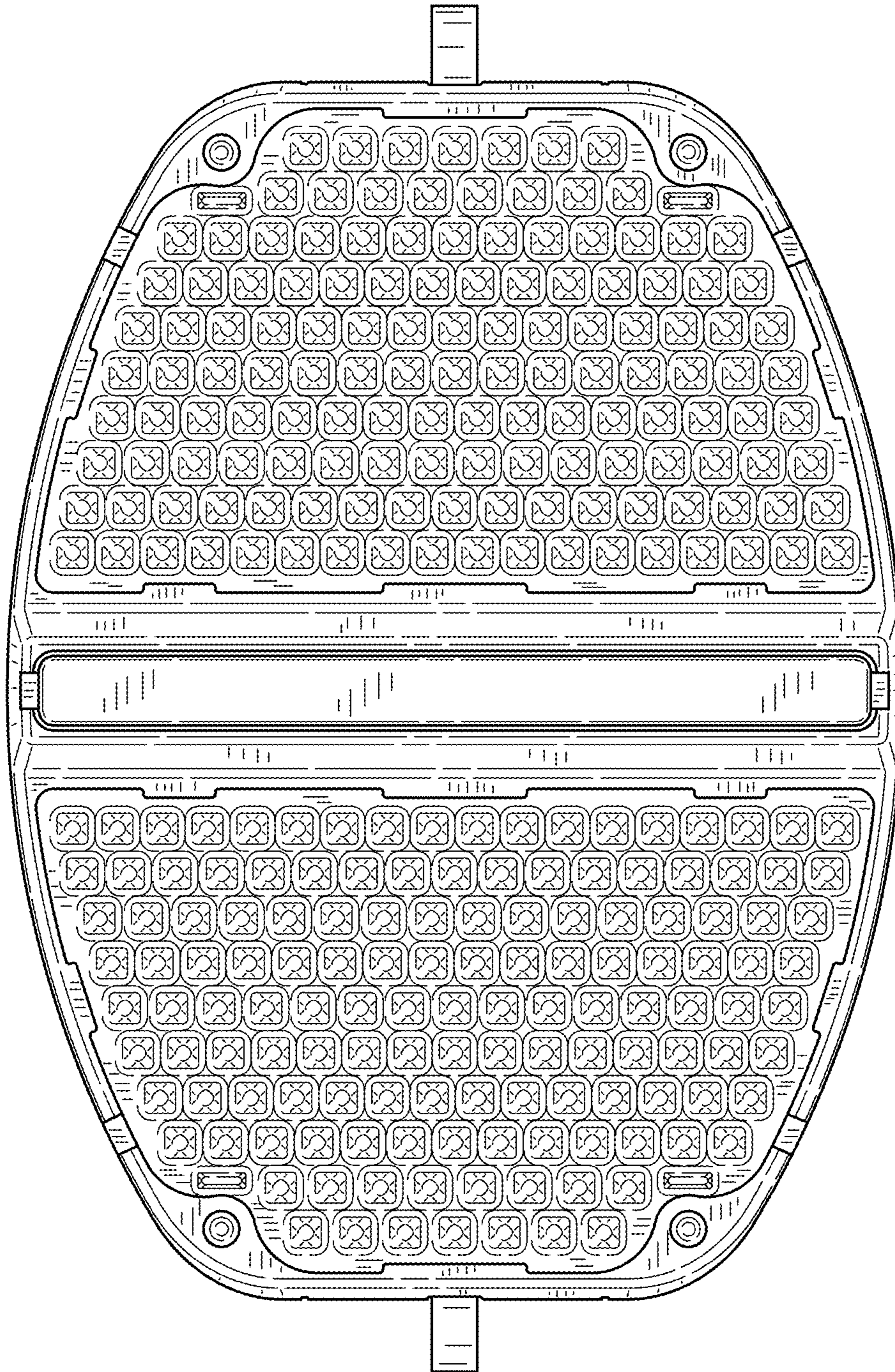

FIG. 3

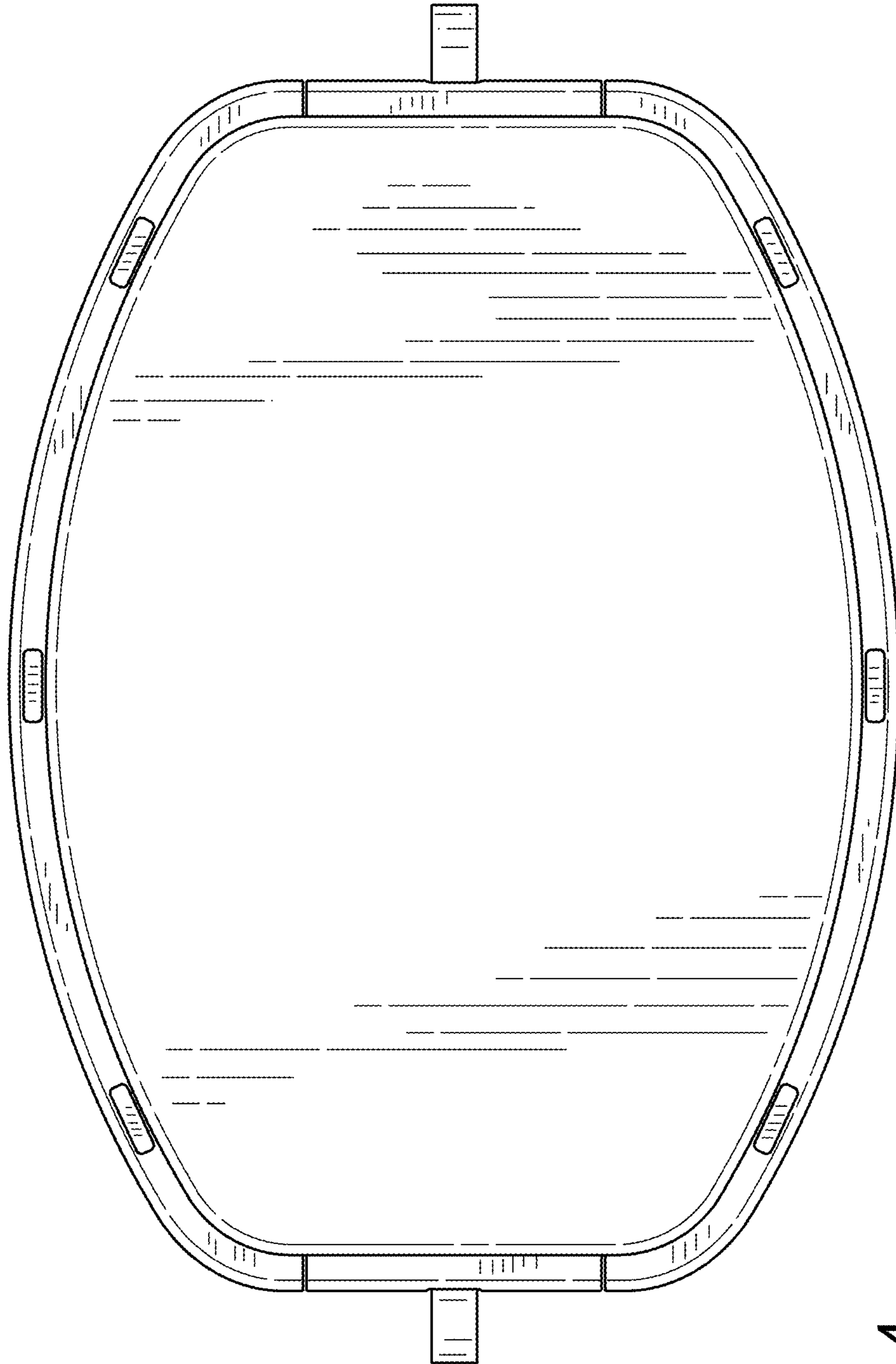

FIG.4

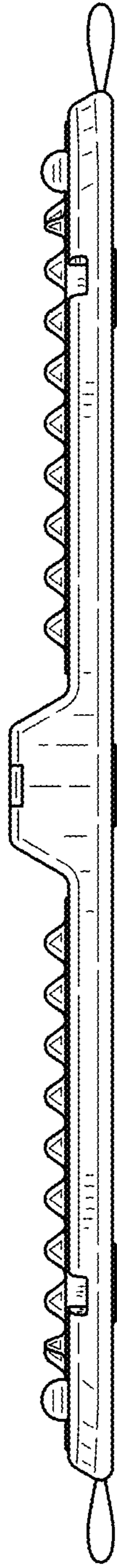

FIG. 5

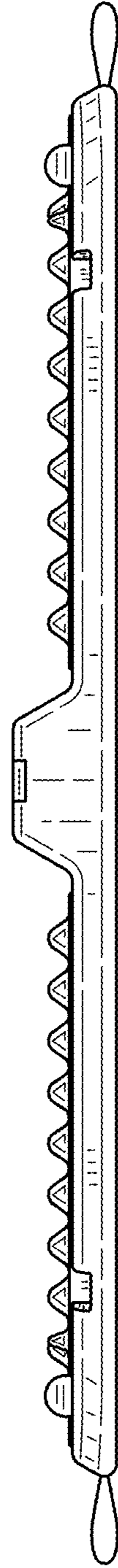

FIG. 6



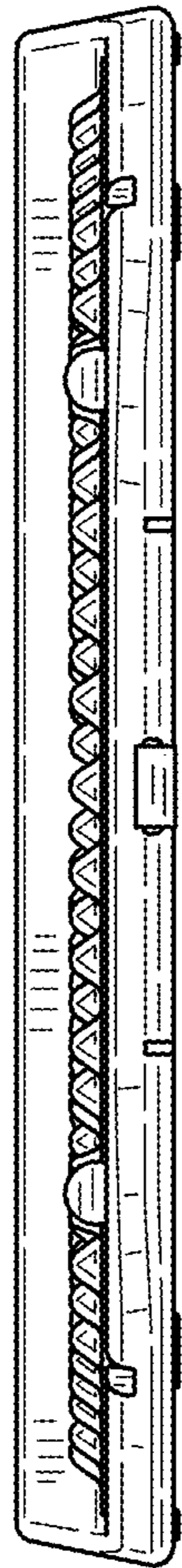

FIG. 7



FIG. 8

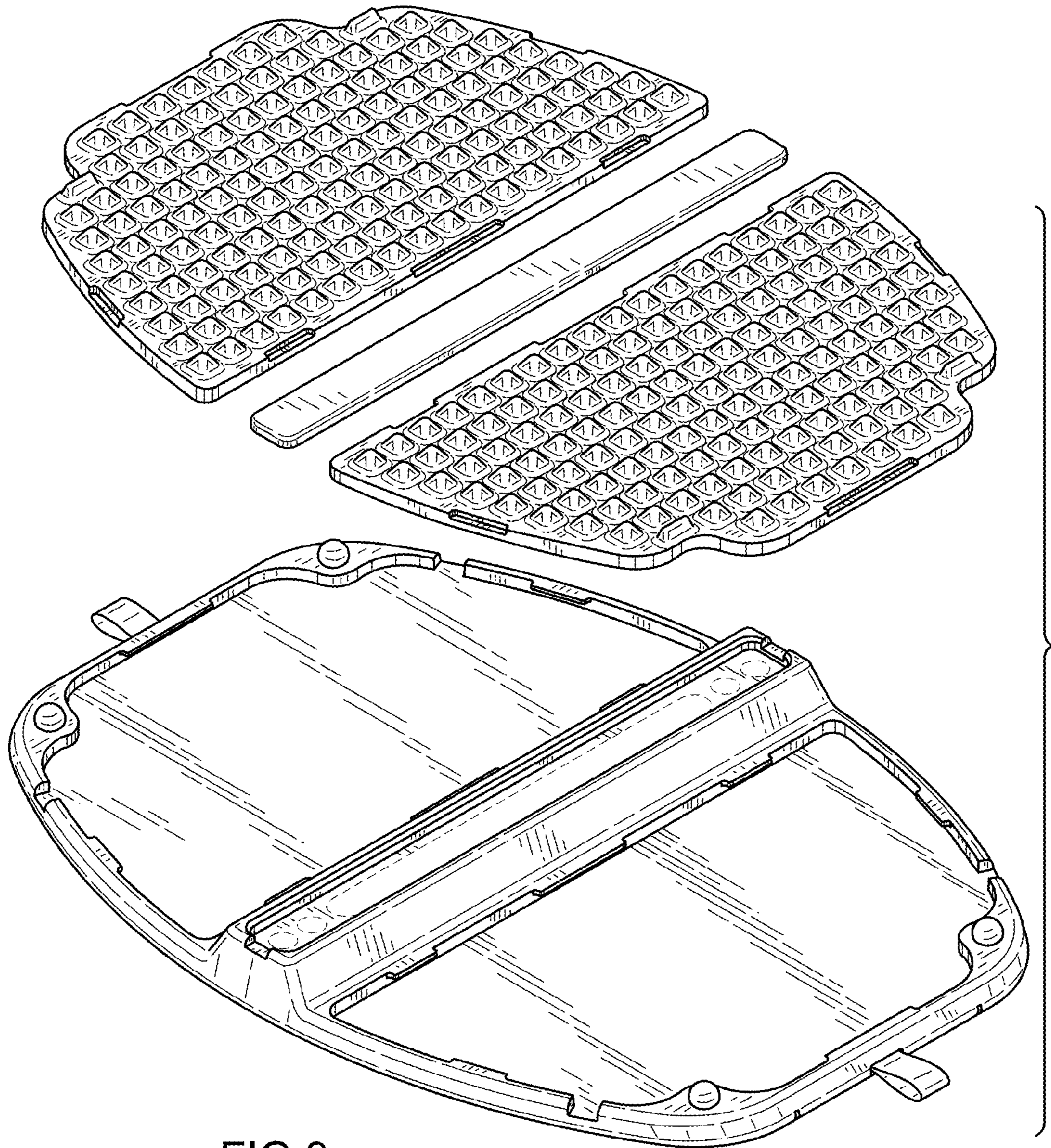

FIG.9



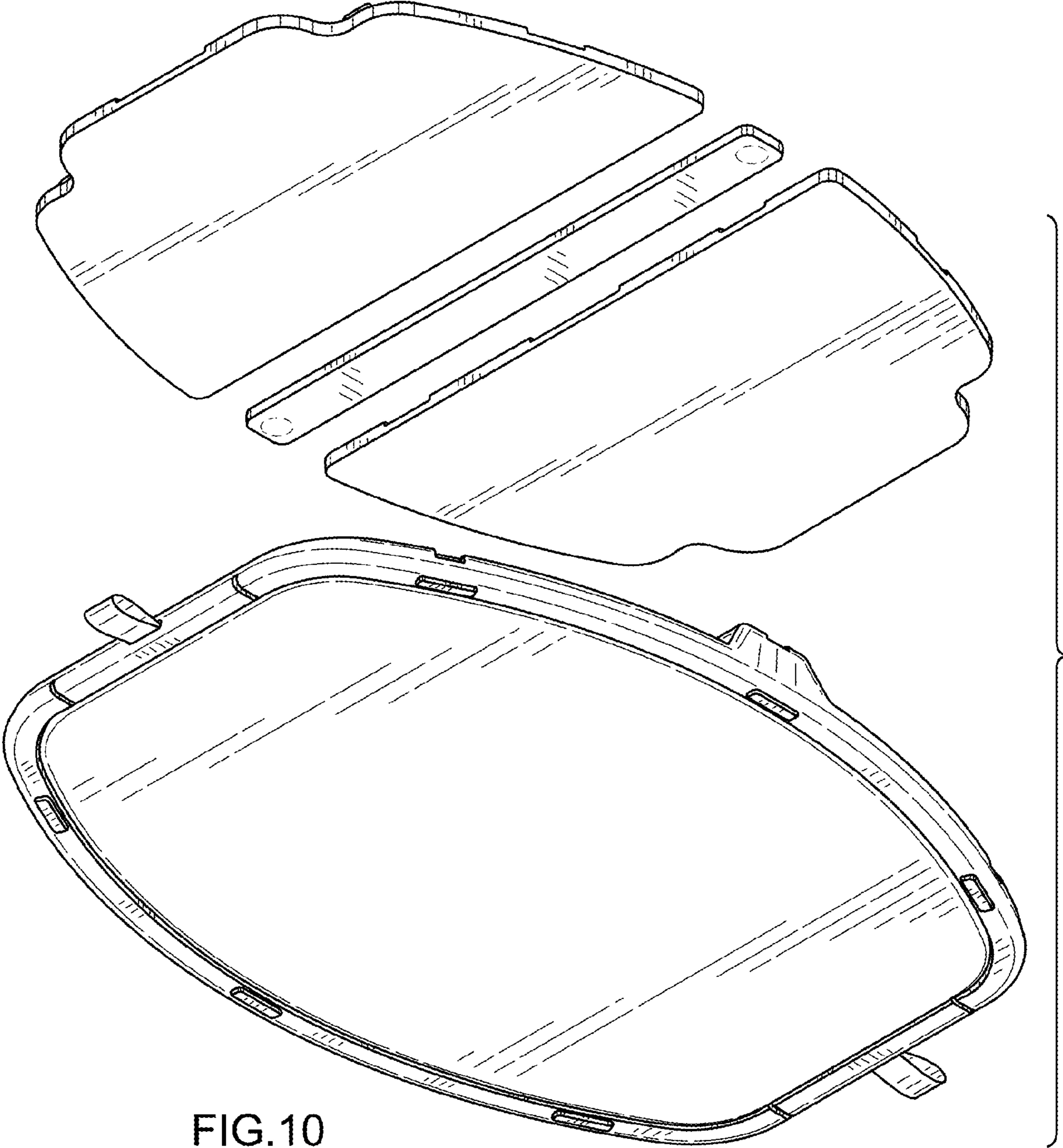

FIG.10

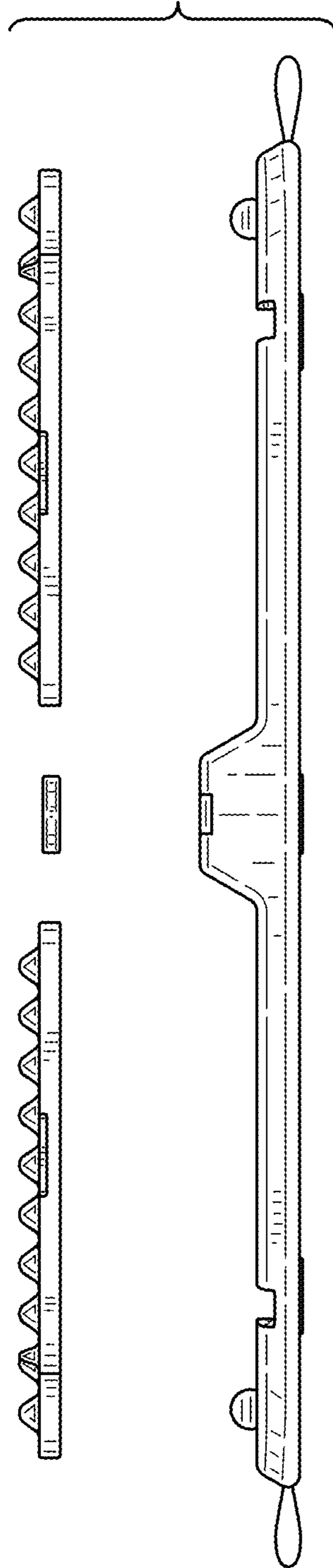

FIG.11



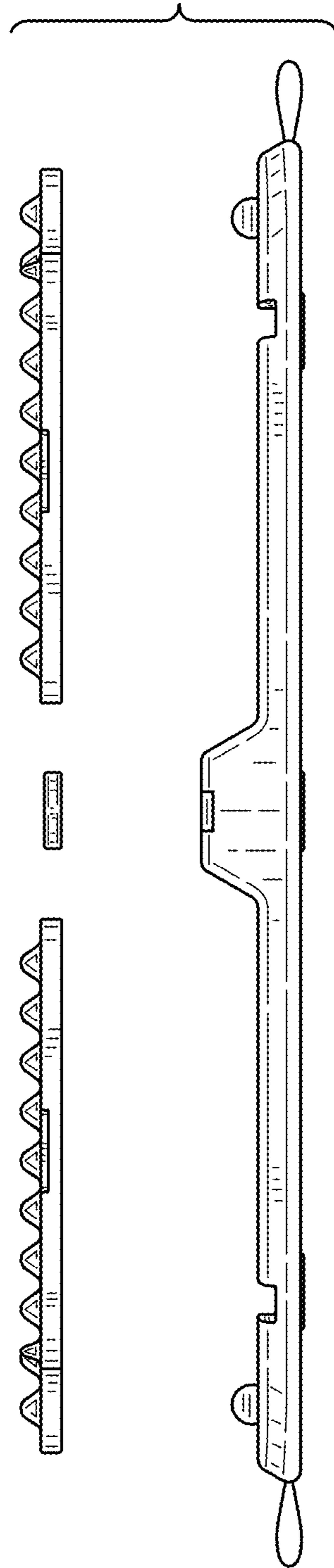

FIG. 12

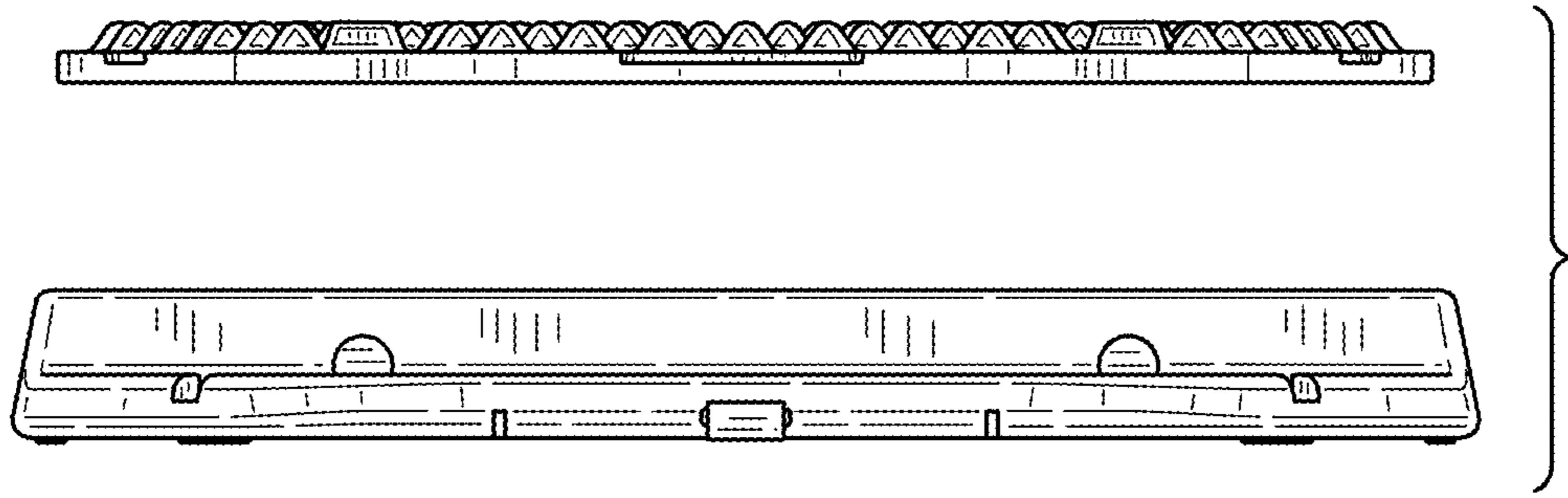

FIG.13

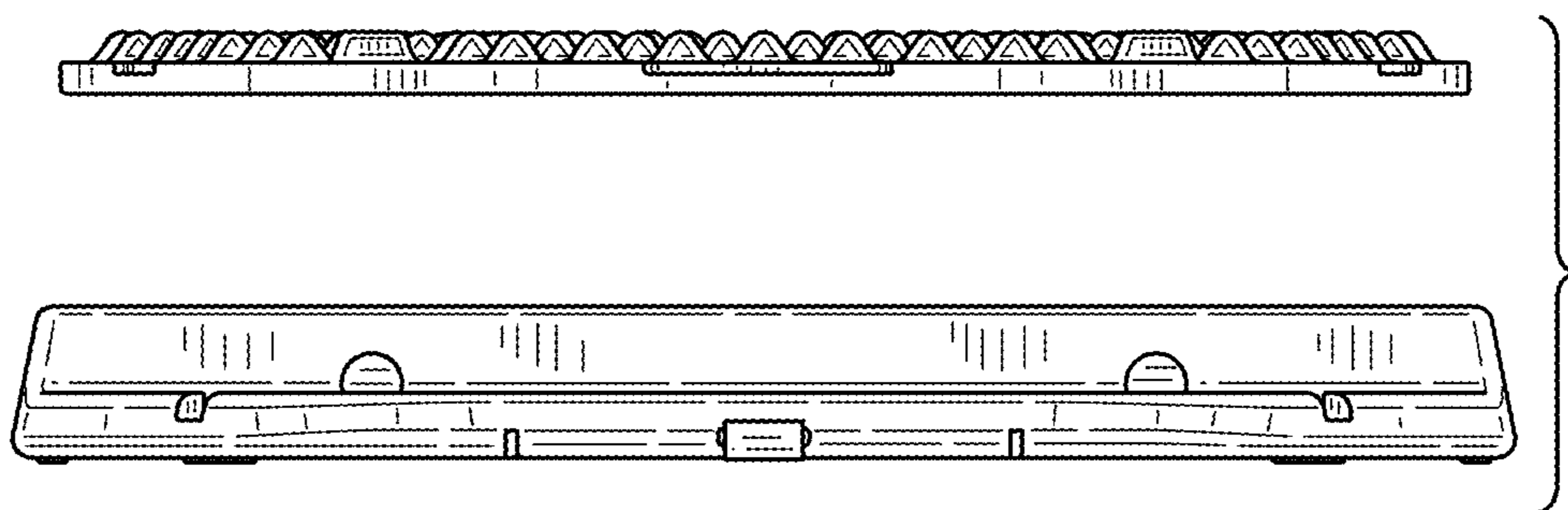

FIG.14