



US00D945812S

(12) **United States Design Patent** (10) **Patent No.:** **US D945,812 S**
McVey et al. (45) **Date of Patent:** **** Mar. 15, 2022**

(54) **COOKING POT**
(71) Applicant: **Weber-Stephen Products LLC**,
Palatine, IL (US)
(72) Inventors: **Cassandra A. S. McVey**, Wheeling, IL
(US); **Romualdo Sonny Siazon**,
Woodstock, IL (US)
(73) Assignee: **WEBER-STEPHEN PRODUCTS**
LLC, Palatine, IL (US)

D373,285 S 9/1996 Coroama et al.
D472,759 S 4/2003 Teisen-Simony et al.
D507,718 S 7/2005 Kellermann et al.
D558,513 S 1/2008 Scholze et al.
D579,713 S * 11/2008 Dodane D7/360
(Continued)

FOREIGN PATENT DOCUMENTS

CN 102697400 10/2012
CN 208808168 5/2019
(Continued)

(**) Term: **15 Years**

OTHER PUBLICATIONS

(21) Appl. No.: **29/743,060**
(22) Filed: **Jul. 17, 2020**
(51) **LOC (13) Cl.** **07-02**
(52) **U.S. Cl.**
USPC **D7/354**; D7/360
(58) **Field of Classification Search**
USPC D7/323, 354-361; D9/428
CPC .. A47J 27/00; A47J 27/04; A47J 27/05; A47J
27/08; A47J 27/09; A47J 27/092; A47J
36/025; A47J 36/06; A47J 36/08; A47J
36/10; A47J 36/12; A47J 37/10; A47J
37/12; A47J 37/1204; A47J 37/1209;
H05B 6/02; H05B 6/06; H05B 6/12
See application file for complete search history.

IP Australia, "Certificate of Registration," issued in connection with
Australian Patent Application No. 202014608, dated Nov. 9, 2020,
8 pages.

(Continued)

Primary Examiner — Ricky Pham
(74) *Attorney, Agent, or Firm* — Hanley, Flight &
Zimmerman, LLC

(57) **CLAIM**

The ornamental design for a "cooking pot," as shown and
described in FIGS. 1-7.

DESCRIPTION

FIG. 1 is a perspective view of a cooking pot.
FIG. 2 is a front view of the cooking pot of FIG. 1.
FIG. 3 is a rear view of the cooking pot of FIG. 1.
FIG. 4 is a right side view of the cooking pot of FIG. 1.
FIG. 5 is a left side view of the cooking pot of FIG. 1.
FIG. 6 is a top view of the cooking pot of FIG. 1; and,
FIG. 7 is a bottom view of the cooking pot of FIG. 1.
The features shown in broken lines form no part of the
claimed design.
The lighter solid lines denote surfaces and contours. Line
shading is not surface ornamentation.

(56) **References Cited**
U.S. PATENT DOCUMENTS

2,199,687 A 5/1940 Blankenship
D176,063 S * 11/1955 Collura D7/360
D221,096 S * 7/1971 Tevolitz D7/360
D232,148 S * 7/1974 Yarrington D7/360
D241,601 S * 9/1976 Cook D7/356
D248,363 S * 7/1978 Rinaldi D7/354
D278,403 S * 4/1985 Cesaroni D7/354
4,666,727 A * 5/1987 Wang A47J 37/10
126/390.1
5,490,452 A 2/1996 Schlosser et al.

1 Claim, 5 Drawing Sheets

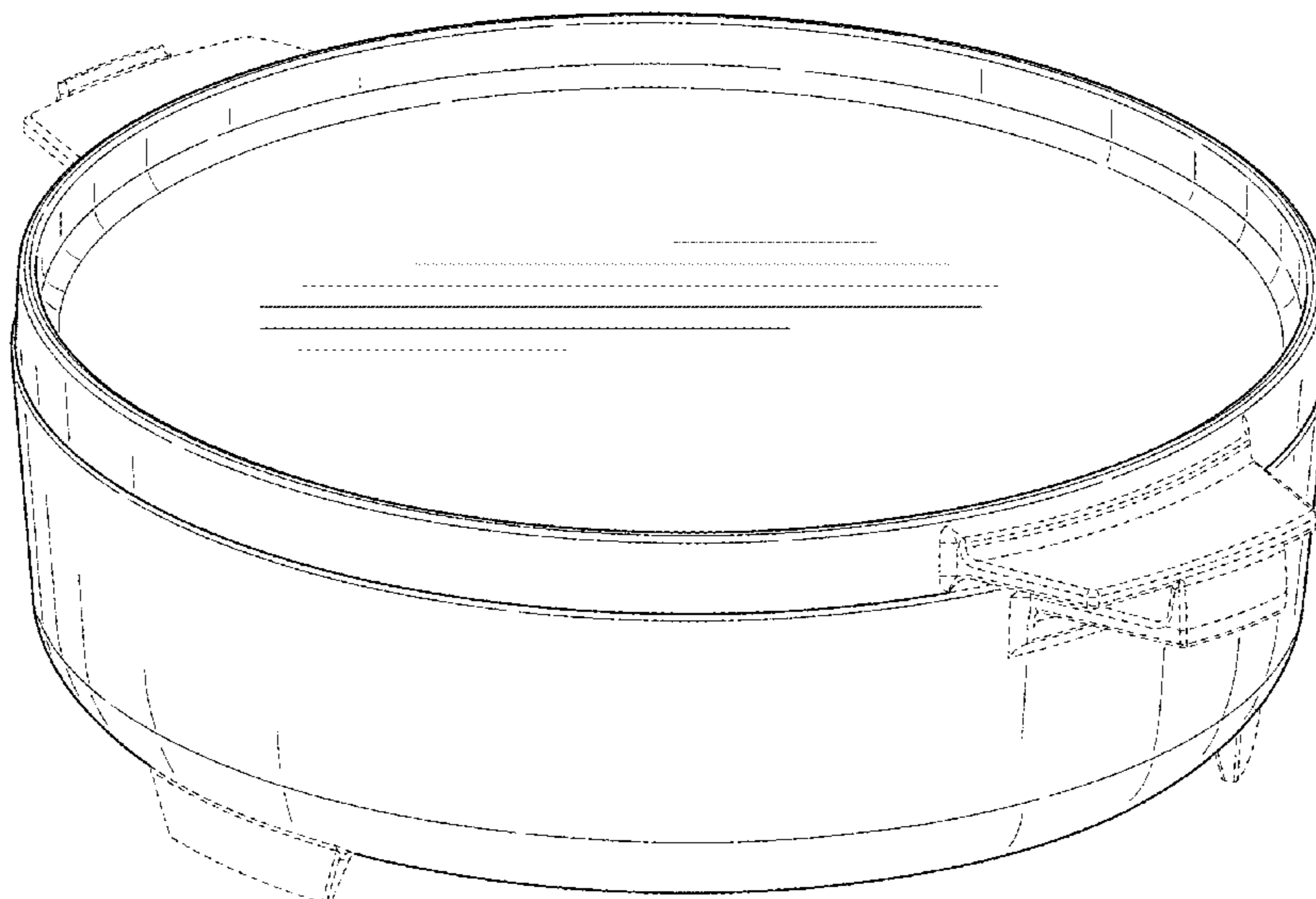

(56)

References Cited

OTHER PUBLICATIONS

U.S. PATENT DOCUMENTS

| | | | |
|--------------|---------|-------------------|--------|
| D584,918 S | 1/2009 | Loring | |
| D587,066 S | 2/2009 | Loring | |
| D618,497 S | 6/2010 | Malaspino et al. | |
| D658,425 S | 5/2012 | Difante | |
| D686,450 S | 7/2013 | Yessin et al. | |
| D687,256 S | 8/2013 | Difante | |
| D708,470 S | 7/2014 | Heiberg et al. | |
| D716,603 S | 11/2014 | Yessin et al. | |
| D719,398 S | 12/2014 | Deters | |
| D722,814 S | 2/2015 | Heiberg et al. | |
| 8,978,547 B2 | 3/2015 | Salvino | |
| D730,112 S | 5/2015 | Yessin et al. | |
| D731,241 S | 6/2015 | Yessin et al. | |
| D732,886 S | 6/2015 | Heiberg et al. | |
| D738,161 S | 9/2015 | Yessin et al. | |
| D739,173 S | 9/2015 | Jalet et al. | |
| D754,469 S | 4/2016 | Deters | |
| D797,492 S * | 9/2017 | Shieh | D7/356 |
| D798,145 S * | 9/2017 | Komai | D9/428 |
| D805,835 S | 12/2017 | Yessin et al. | |
| D805,836 S | 12/2017 | Yessin et al. | |
| D807,116 S | 1/2018 | Fariello | |
| D871,129 S | 12/2019 | Peterson | |
| D871,139 S | 12/2019 | Peterson | |
| D877,556 S | 3/2020 | Saad | |
| D880,934 S | 4/2020 | Kellermann et al. | |
| D907,953 S * | 1/2021 | Vallee | D7/354 |
| D915,124 S * | 4/2021 | Vallee | D7/354 |
| D916,547 S * | 4/2021 | Tehrani | D7/361 |

FOREIGN PATENT DOCUMENTS

| | | |
|----|---------------|---------|
| CN | 209058911 | 7/2019 |
| DE | 102007054154 | 5/2009 |
| JP | 2000166773 | 6/2000 |
| JP | 1146792 | 7/2002 |
| JP | 3179050 | 10/2012 |
| JP | 1480096 | 9/2013 |
| JP | 1480099 | 9/2013 |
| JP | 1505664 | 8/2014 |
| JP | 1601796 | 4/2018 |
| KR | 3009831140000 | 11/2018 |
| KR | 101945253 | 2/2019 |
| KR | 3010022660000 | 4/2019 |
| KR | 3010088390000 | 5/2019 |
| KR | 3010598770000 | 5/2020 |
| TW | 254609 | 8/1995 |
| TW | 440160 | 6/2001 |
| TW | D174838 | 8/2015 |
| TW | D185889 | 10/2017 |
| TW | D201171 | 6/2018 |

China National Intellectual Property Administration, "Notice of Decision of Grant of Patent," issued in connection with Chinese Patent Application No. 202030531343.7, dated Jan. 6, 2021, 4 pages.

European Union Intellectual Property Office, "Certificate of Registration No. 008166938-0001," issued on Sep. 12, 2020, 4 pages.

IP Australia, "Certificate of Examination," issued in connection with Australian Patent Application No. 202014608, dated Mar. 8, 2021, 2 pages.

International Searching Authority, "International Search Report and Written Opinion," issued in connection with International Patent Application No. PCT/US2020/047205, dated Apr. 2, 2021, 10 pages.

Allbeli Multi-Dutch Oven, "Online Data Sheet," dated Apr. 1, 2014, Retrieved from the Internet [URL:https://cafe.naver.com/wecampstory/15267] on Mar. 18, 2021, 5 pages. (Translation not available).

Taiwan Patent Office, "Allowance Decision of Examination," issued in connection with Taiwan Patent Application No. 110300041, dated May 11, 2021, 5 pages.

China National Intellectual Property Administration, "Design Certificate," issued in connection with Chinese Design Patent No. ZL 202030531347.5, dated Jan. 29, 2021, 3 pages.

IP Australia, "Certificate of Examination," issued in connection with Australian Patent Application No. 202014609, dated Mar. 8, 2021, 2 pages.

IP Australia, "Certificate of Registration," issued in connection with Australian Patent Application No. 202014609, dated Nov. 9, 2020, 8 pages.

China National Intellectual Property Administration, "Notice of Completion of Formalities for Patent Register," issued in connection with Chinese Patent Application No. 202030531347.5, dated Jan. 5, 2021, 4 pages.

China National Intellectual Property Administration, "Design Certificate," issued in connection with Chinese Design Patent No. ZL 202030531343.7, dated Feb. 5, 2021, 3 pages.

Taiwan Patent Office, "Office Action," issued in connection with Taiwan Patent Application No. 110300040, dated May 26, 2021, 6 pages.

Taiwan Patent Office, "Allowance Decision of Examination," issued in connection with Taiwan Patent Application No. 110300040, dated Aug. 3, 2021, 3 pages.

Taiwan Patent Office, "Office Action and Search Report," issued in connection with Taiwan Patent Application No. 110100623, dated Sep. 22, 2021, 13 pages. (Translation provided).

Taiwan Patent Office, "Allowance Decision of Examination," issued in connection with Taiwan Patent Application No. 110100623, dated Nov. 9, 2021, 3 pages.(Translation provided).

* cited by examiner

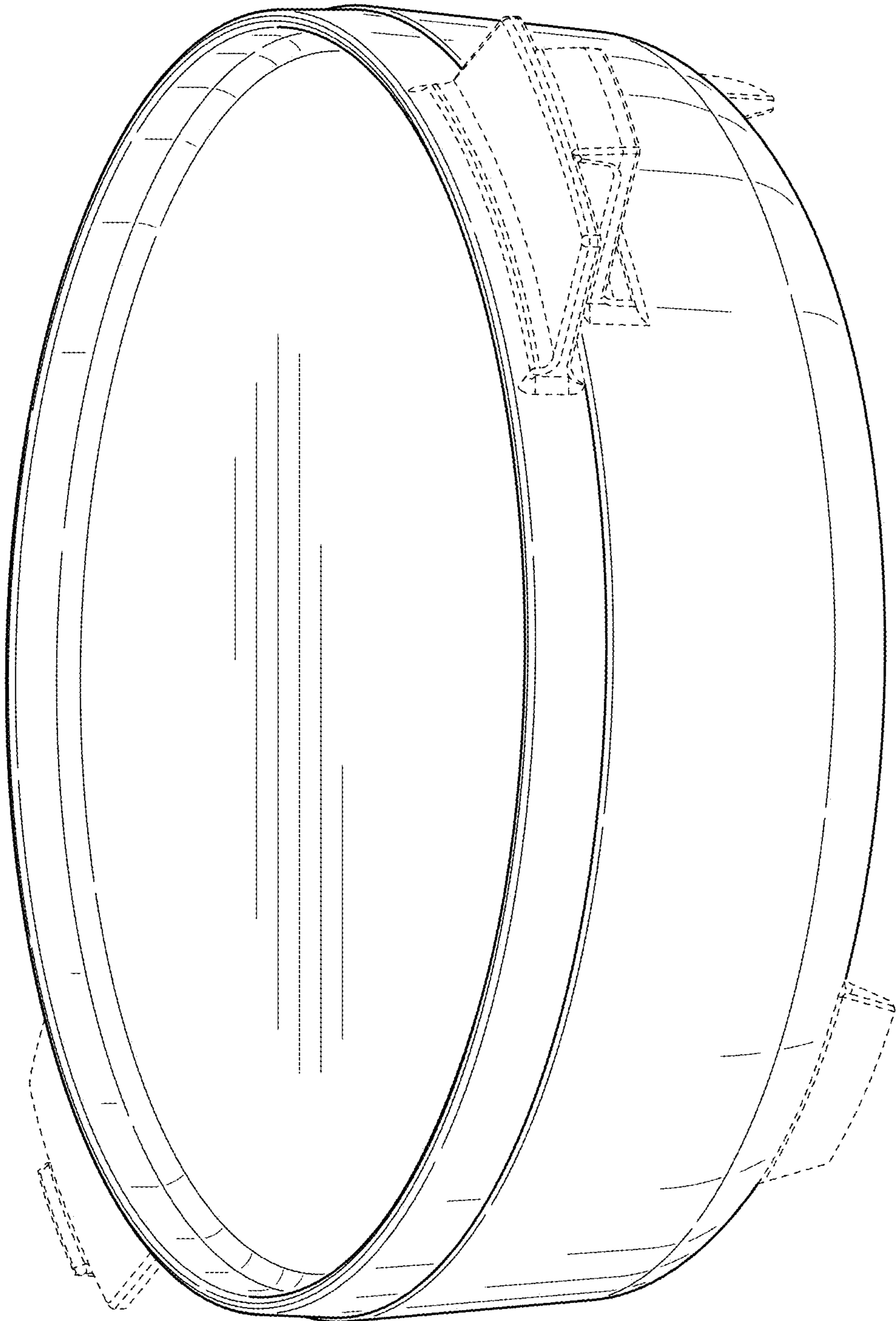

FIG. 1

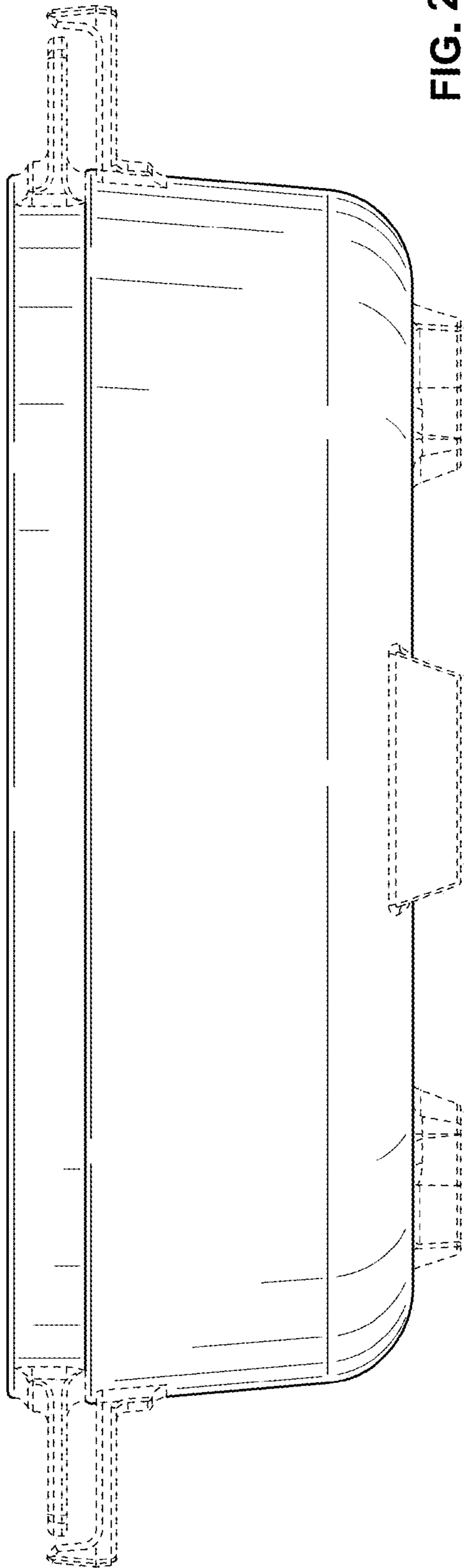

FIG. 2

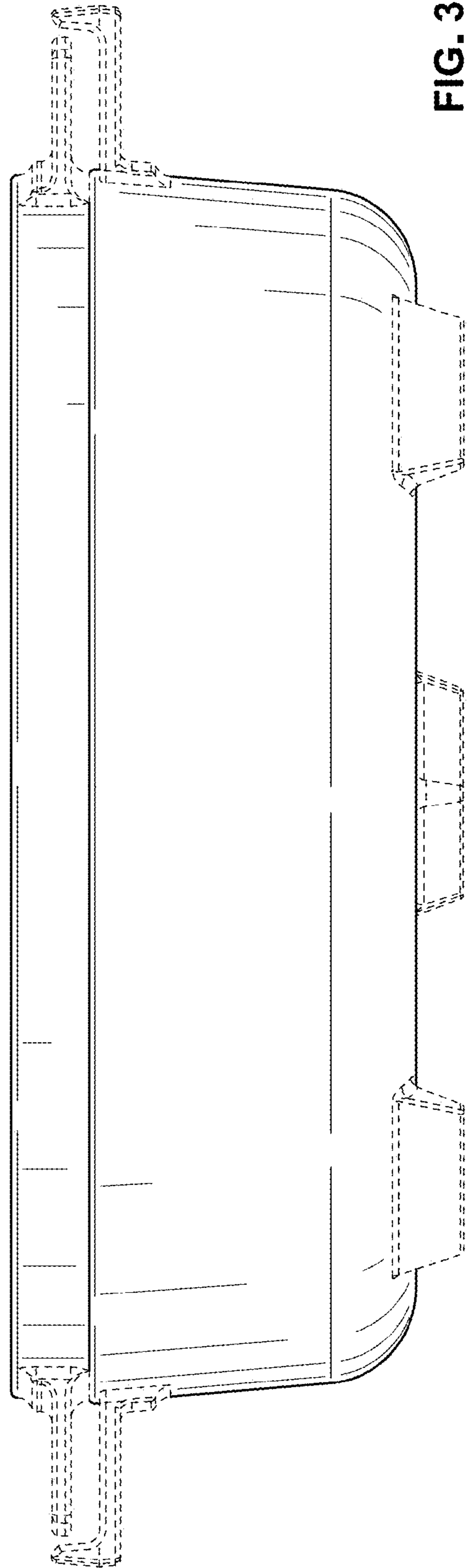

FIG. 3

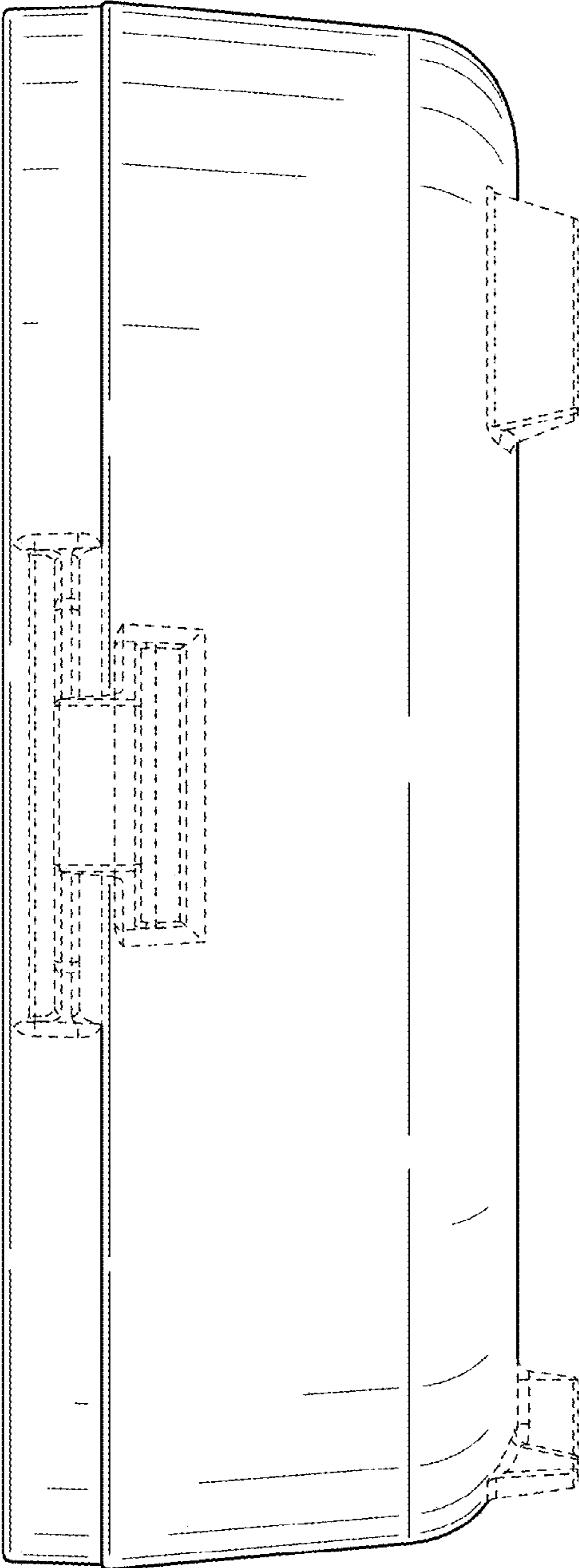

FIG. 4

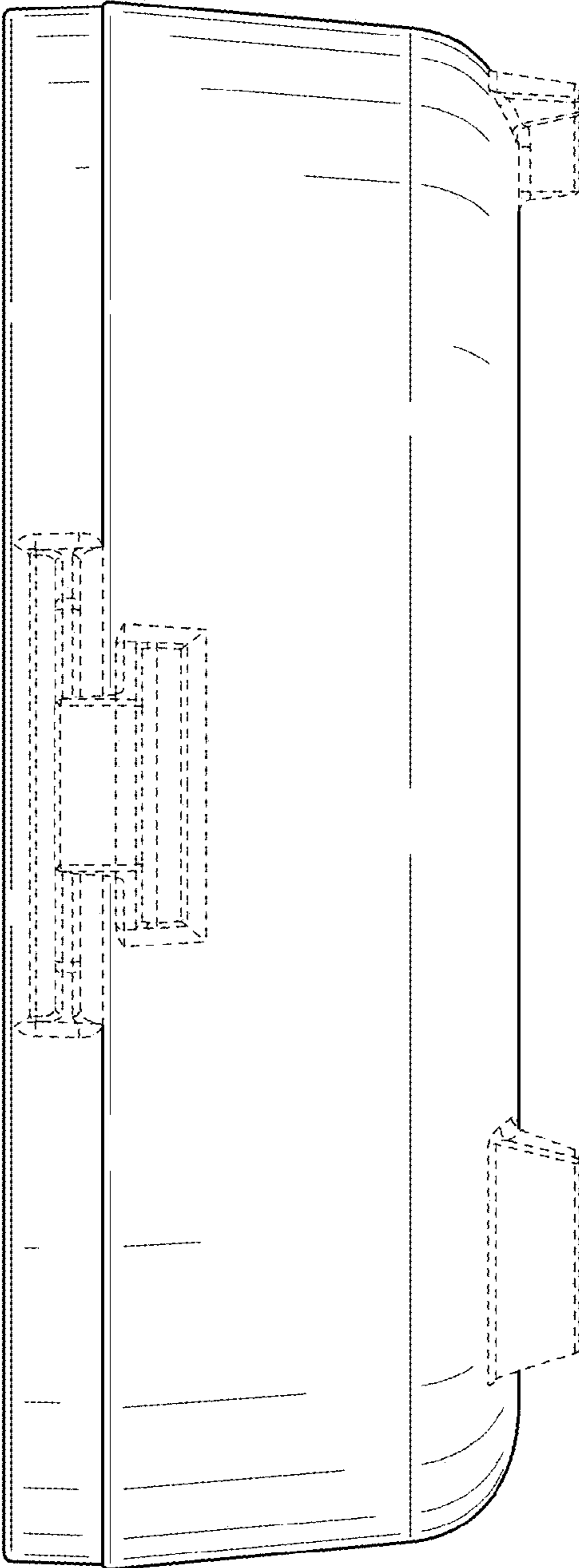

FIG. 5

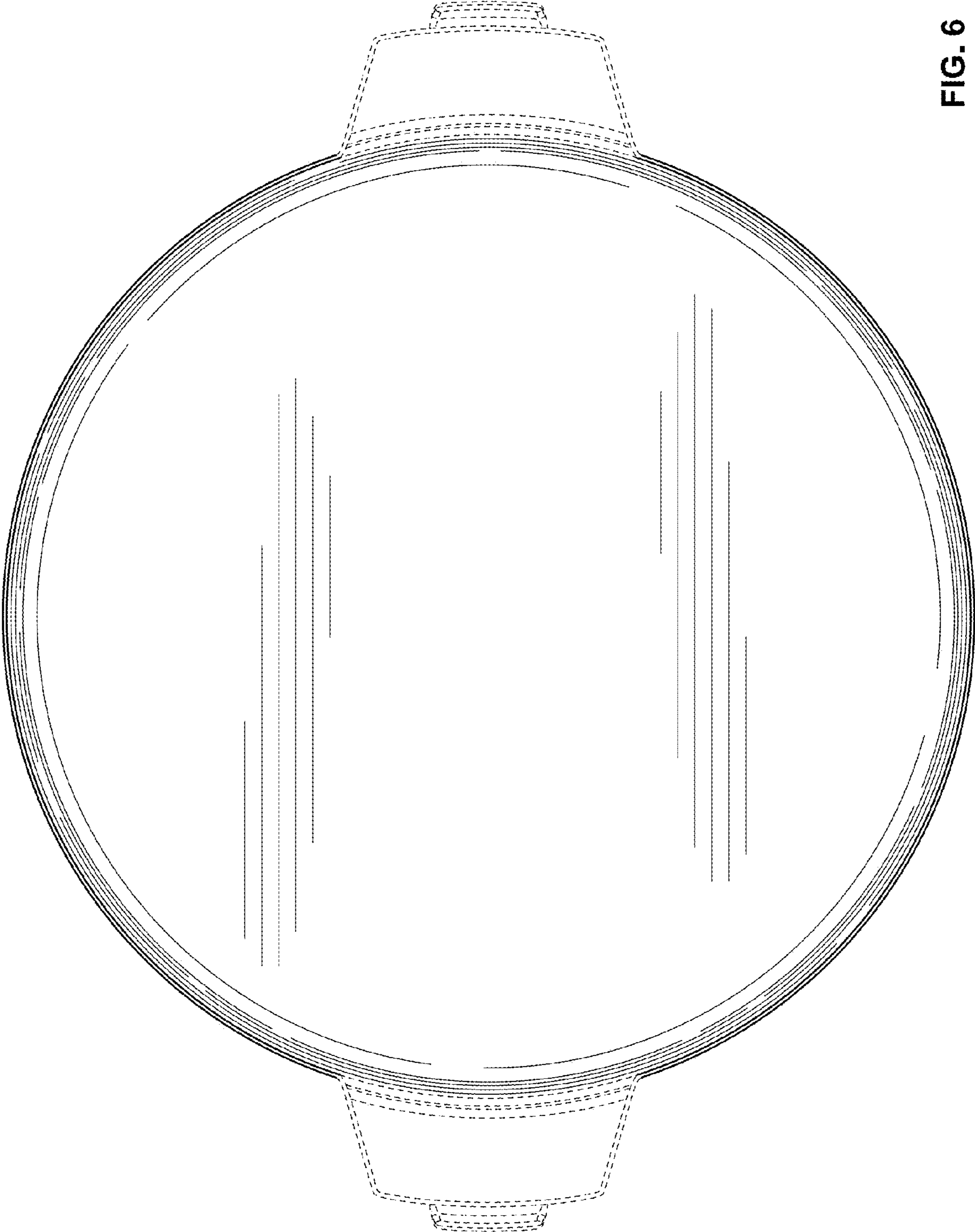

FIG. 6

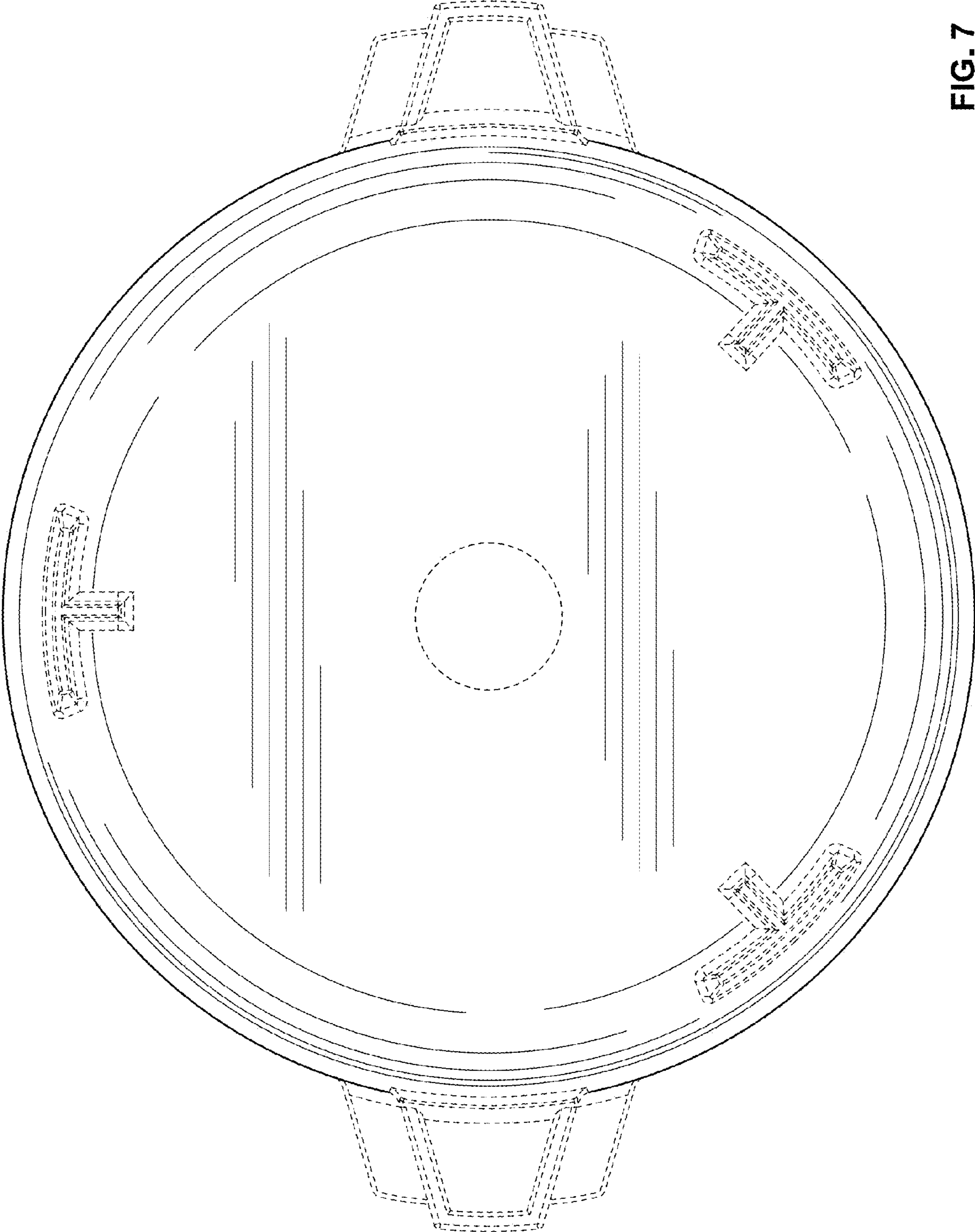

FIG. 7