



US00D945807S

(12) **United States Design Patent**
Mezzera

(10) **Patent No.:** **US D945,807 S**
(45) **Date of Patent:** **** Mar. 15, 2022**

- (54) **BACK AND SEAT FOR A CHAIR**
- (71) Applicant: **Marcelo Mezzera**, Rancho Santa Margarita, CA (US)
- (72) Inventor: **Marcelo Mezzera**, Rancho Santa Margarita, CA (US)
- (**) Term: **15 Years**
- (21) Appl. No.: **29/745,756**
- (22) Filed: **Aug. 7, 2020**
- (51) **LOC (13) Cl.** **06-01**
- (52) **U.S. Cl.**
USPC **D6/716.1**
- (58) **Field of Classification Search**
USPC D6/334, 364, 365, 366, 370, 371, 373, D6/374, 379, 380, 716.1, 716.4
CPC A47C 3/00; A47C 3/04; A47C 3/12; A47C 3/18; A47C 3/20; A47C 1/143; A47C 1/12; A47C 1/121; A47C 1/124; A47C 7/24; A47C 7/36; A47C 7/46; A47C 7/18; A47C 7/40; A47C 7/54
See application file for complete search history.

(56) **References Cited**

U.S. PATENT DOCUMENTS

D254,278 S *	2/1980	Wilson	D6/366
D262,244 S *	12/1981	Wilson	D6/379
D270,117 S *	8/1983	Iurcovich	D6/379
D288,870 S *	3/1987	Biscarini	D6/368
D384,827 S *	10/1997	Hutton	D6/334
D596,413 S *	7/2009	Cagani	D6/334
D766,637 S *	9/2016	Kirar	D6/716
D905,996 S *	12/2020	Li	D6/374
D912,415 S *	3/2021	Tsai	D6/364

D918,611 S *	5/2021	Wang	D6/366
D919,988 S *	5/2021	Li	D6/366
2011/0304183 A1 *	12/2011	van Hekken	A47C 3/12 297/313

OTHER PUBLICATIONS

Restaurant Furniture 4 Less. <https://www.restaurantfurniture4less.com/GO-1691-1-PUR-A-GG.html>. "Mid-Back Purple Quilted Vinyl Swivel Task Office Chair with Arms". Date Unknown: Viewed Jul. 2021 (Year: 2021).*

* cited by examiner

Primary Examiner — R. Johnson

(74) *Attorney, Agent, or Firm* — Morland C. Fischer

(57) **CLAIM**

The ornamental design for a back and seat for a chair, as shown and described.

DESCRIPTION

FIG. 1 is a front, top, right perspective view of a back and seat for a chair showing my new design; FIG. 2 is a rear, top, left perspective view thereof; FIG. 3 is a front devotional view thereof; FIG. 4 is a right side devotional view thereof; FIG. 5 is a rear elevational view thereof; FIG. 6 is a left side elevational view thereof; FIG. 7 is a top plan view thereof; and, FIG. 8 is a bottom plan view thereof. The broken lines represent environment, which forms no part of the claim design.

1 Claim, 7 Drawing Sheets

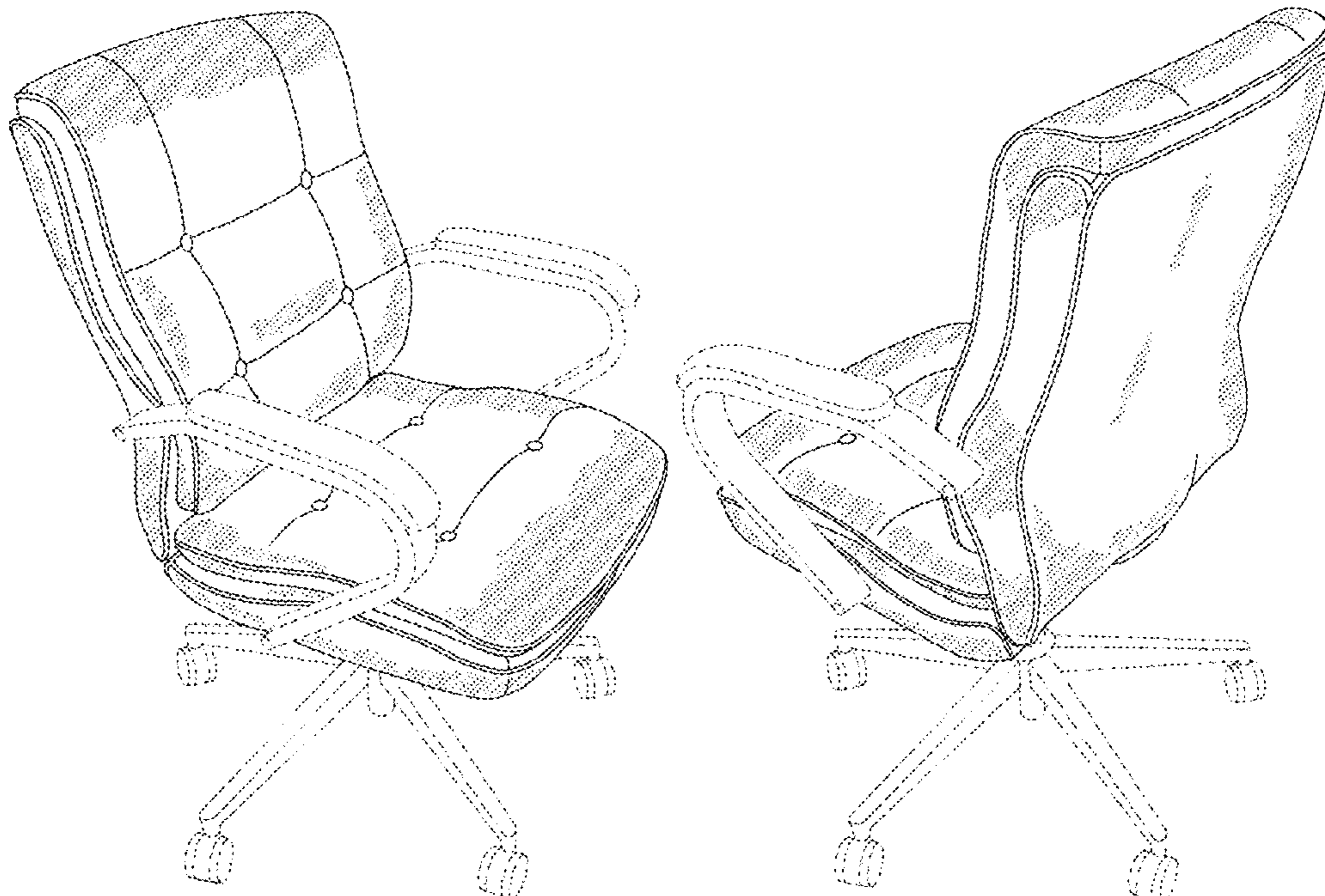

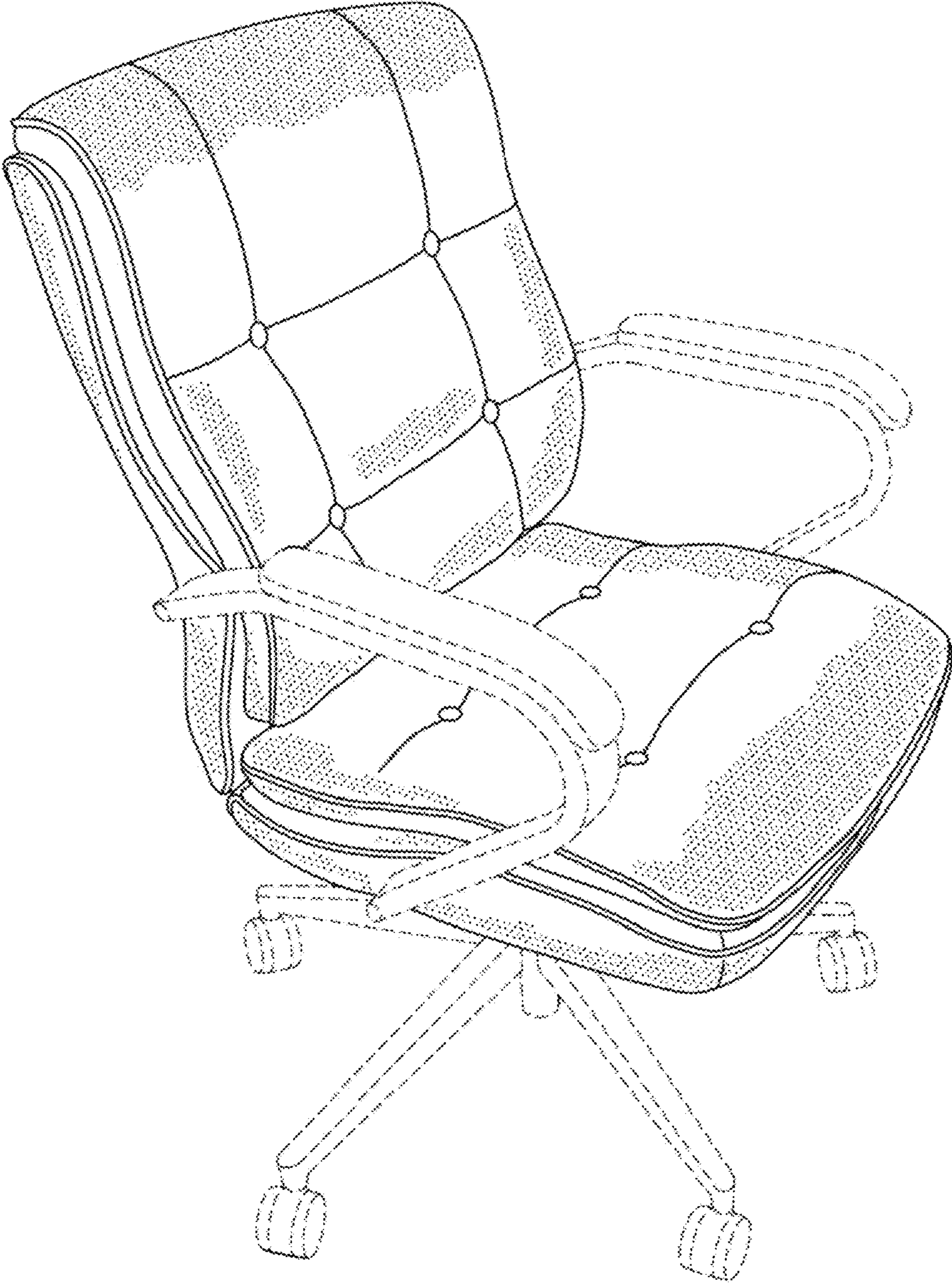

FIG. 1

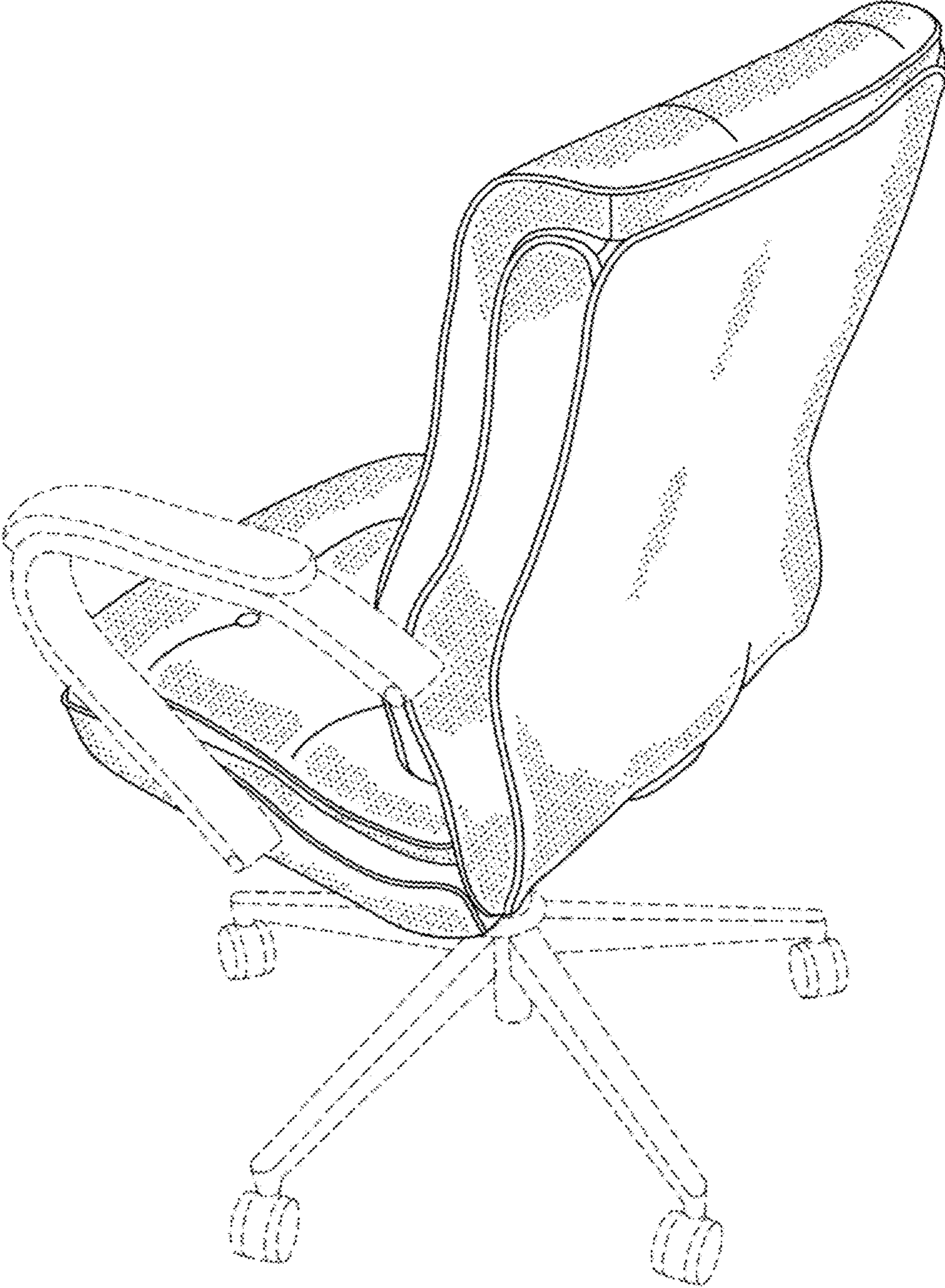

FIG. 2

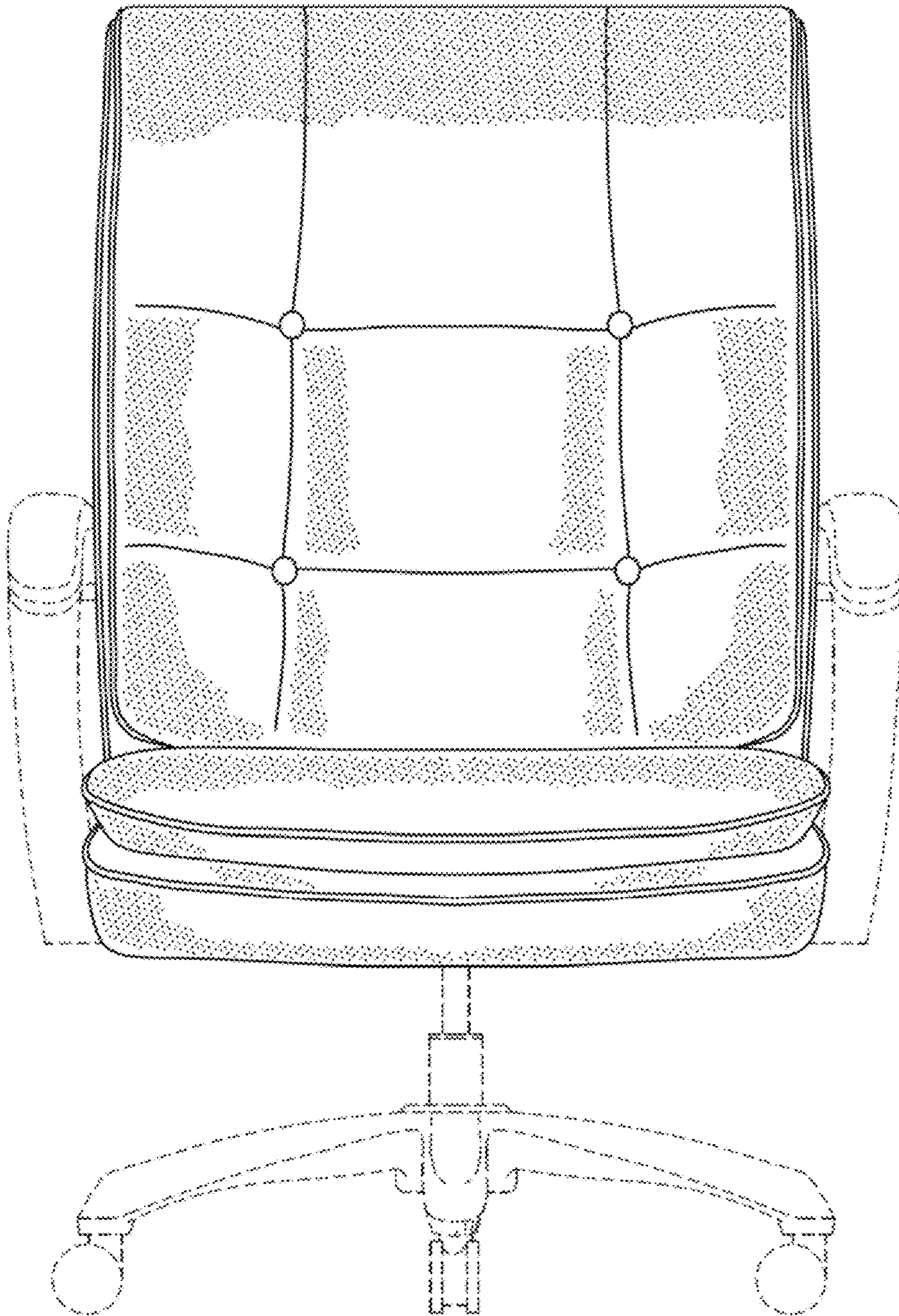

FIG. 3

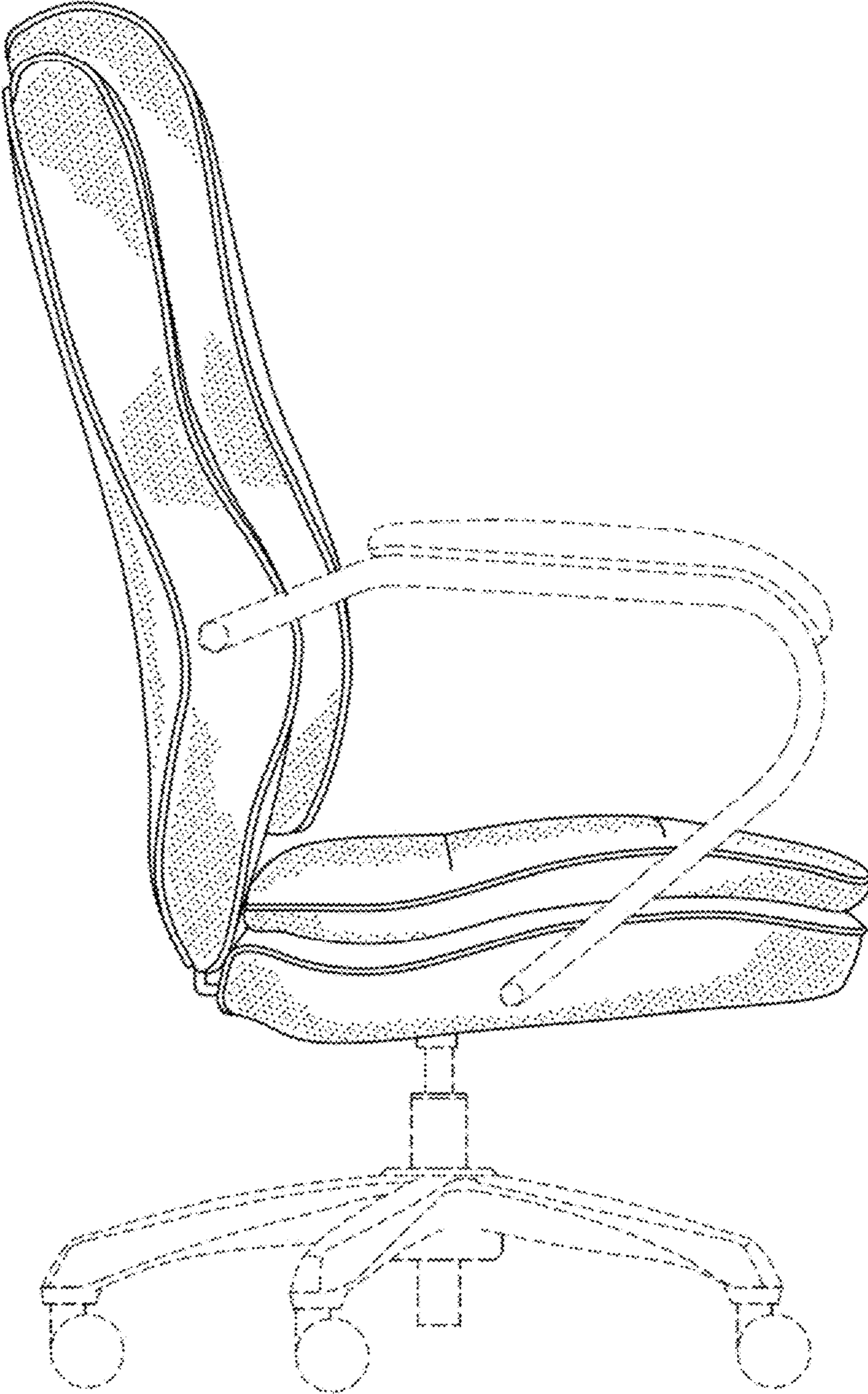

FIG. 4

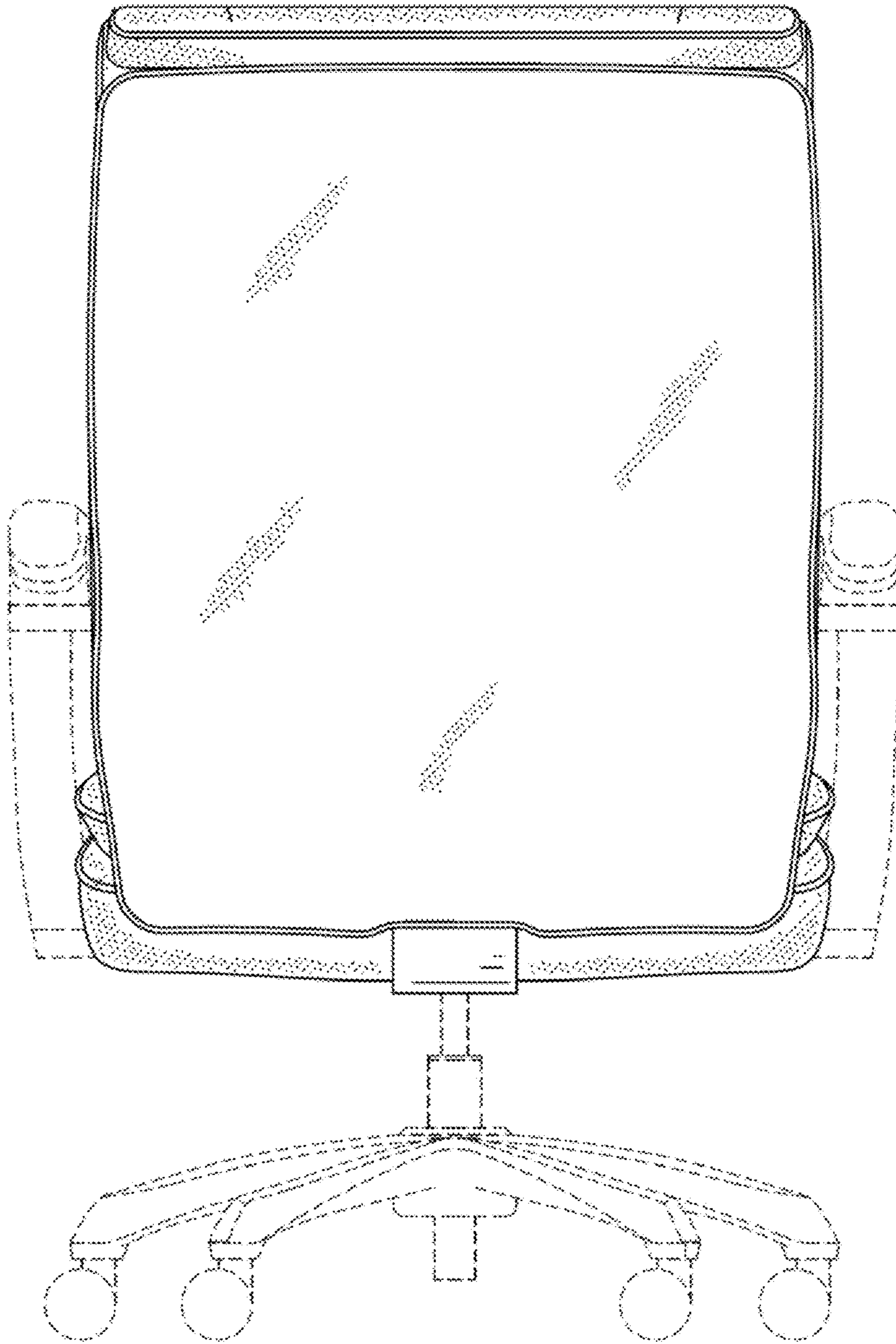

FIG. 5

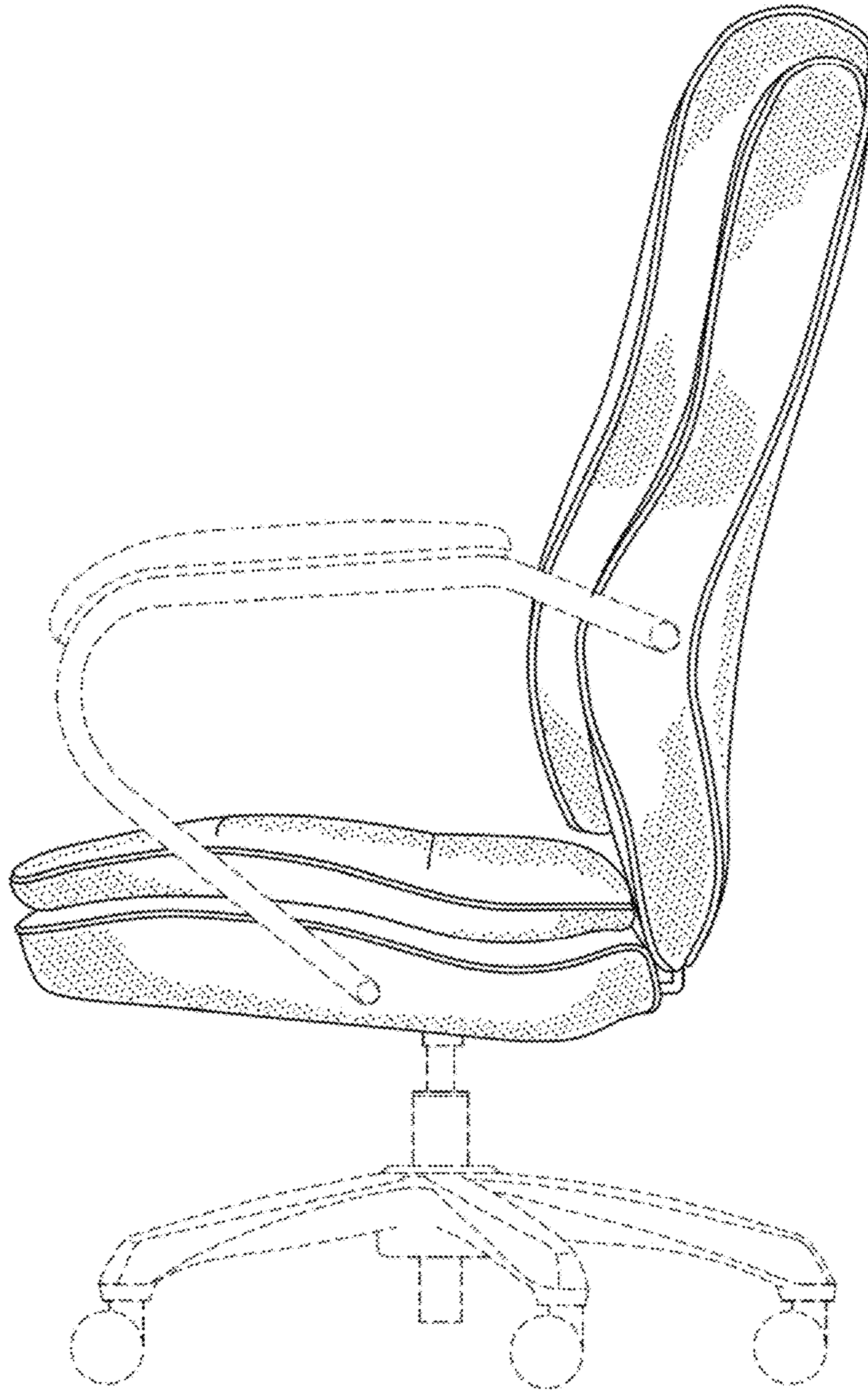

FIG. 6

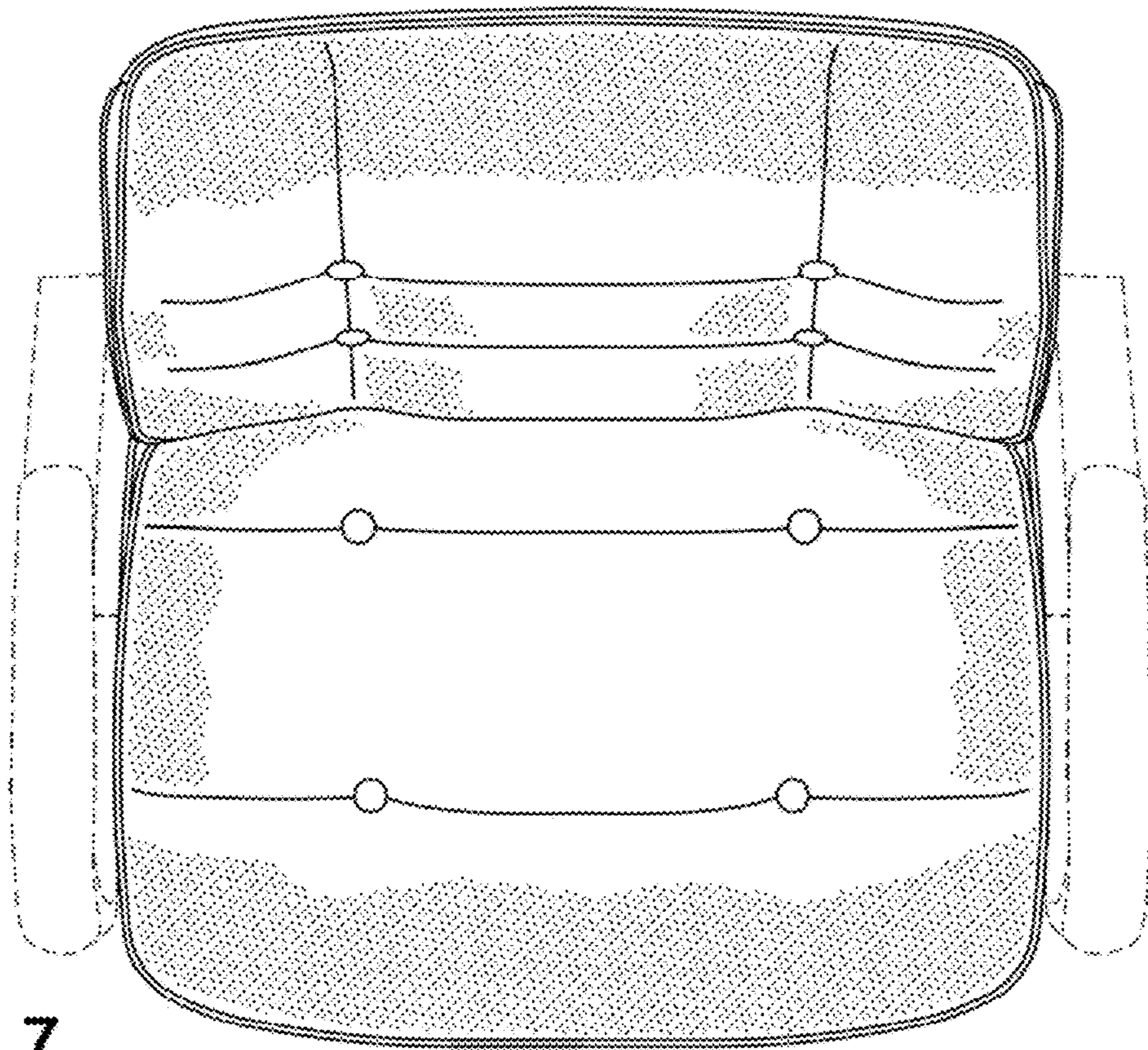

FIG. 7

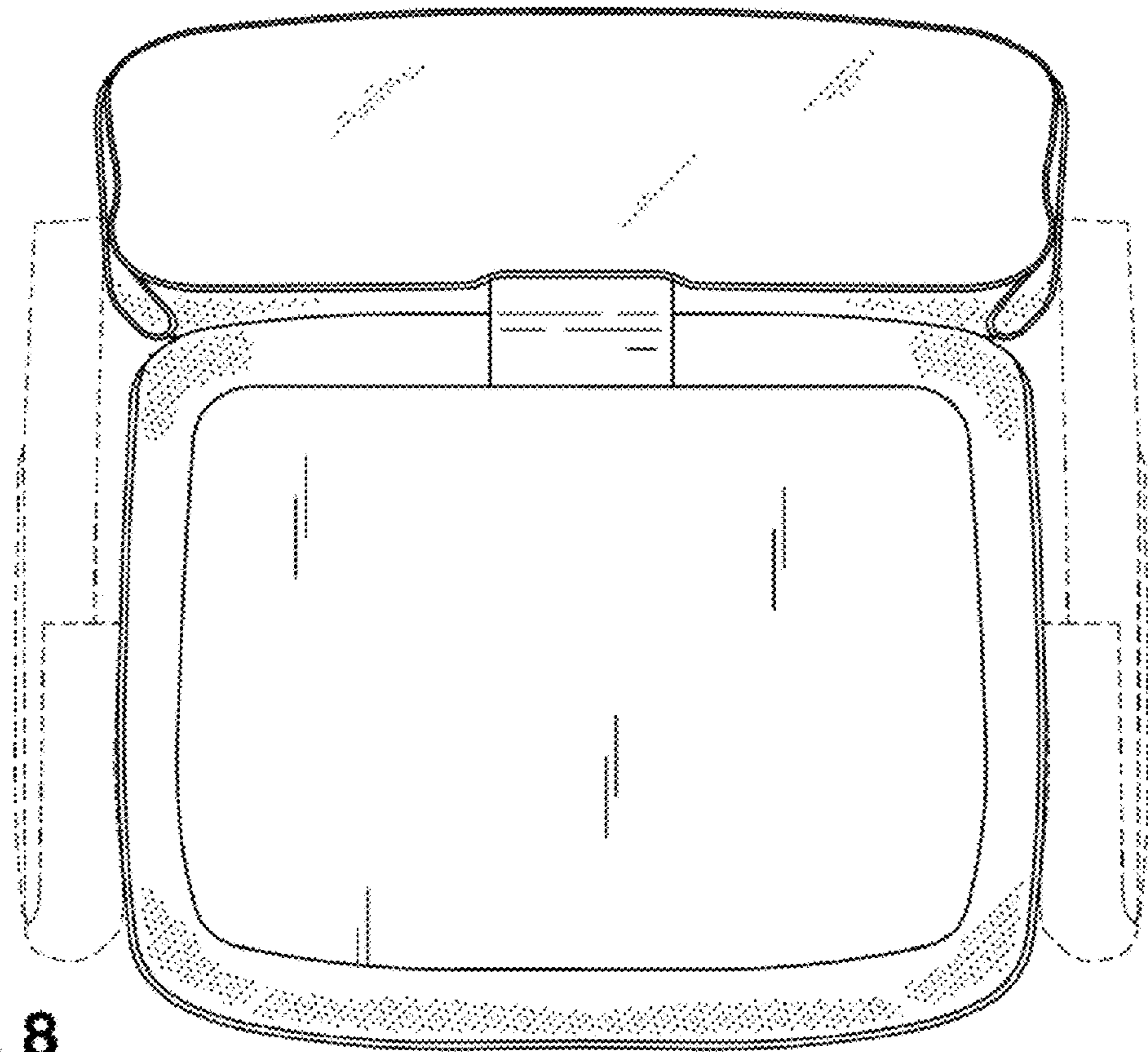

FIG. 8