



US00D945805S

(12) **United States Design Patent**  
**Cooper**

(10) **Patent No.:** **US D945,805 S**

(45) **Date of Patent:** **\*\* Mar. 15, 2022**

(54) **CROSS TABLE**

(71) Applicant: **Christine R. Cooper**, Spout Spring, VA  
(US)

(72) Inventor: **Christine R. Cooper**, Spout Spring, VA  
(US)

(\*\*) Term: **15 Years**

(21) Appl. No.: **29/705,004**

(22) Filed: **Sep. 9, 2019**

(51) **LOC (13) Cl.** ..... **06-03**

(52) **U.S. Cl.**  
USPC ..... **D6/688**

(58) **Field of Classification Search**  
USPC ..... D6/329, 382, 383, 384, 388, 641, 642,  
D6/644, 645, 649, 656, 656.1, 658, 665,  
D6/674, 678, 685, 688, 690, 695, 695.1,  
D6/707.1  
CPC ..... A47G 33/02; A47G 33/00; A47B 13/04;  
A47B 13/08; A47B 19/02

See application file for complete search history.

(56) **References Cited**

**U.S. PATENT DOCUMENTS**

1,286,911	A *	12/1918	Bakula	.....	A44C 1/00 63/1.14
2,030,356	A *	2/1936	Dibb	.....	A45C 1/12 206/0.815
2,246,122	A *	6/1941	Brennan	.....	B44C 1/26 428/3
D144,565	S *	4/1946	Hollis	.....	D6/695
2,712,191	A *	7/1955	Hillenbrand	.....	A61G 17/04 428/3
D242,406	S *	11/1976	Romanoff	.....	D6/559
4,058,929	A *	11/1977	O'Connell	.....	A01G 5/04 47/41.12
D314,293	S *	2/1991	Prendergast	.....	D6/674
D540,817	S *	4/2007	Milstein	.....	D14/203.2
D578,275	S *	10/2008	Shantz	.....	D99/17

D639,701	S *	6/2011	Ditty	.....	D11/96
D653,160	S *	1/2012	Ford	.....	D11/149
D663,095	S *	7/2012	Naimi	.....	D99/27
D671,770	S *	12/2012	Kroll	.....	D6/674
D688,591	S *	8/2013	Merrell	.....	D11/149
D706,515	S *	6/2014	Zabarsky	.....	D99/25
D730,085	S *	5/2015	Liu	.....	D6/642
RE45,843	E *	1/2016	Kroll	.....	D6/674

(Continued)

**OTHER PUBLICATIONS**

“Seating Arrangement For Your Next Event.” Found online Dec. 3, 2021 at [www.jilliannicoleevents.com](http://www.jilliannicoleevents.com). Page dated Apr. 28, 2021. Retrieved from URL: <https://jilliannicoleevents.com/seating-arrangement-for-your-next-event/> (Year: 2021).\*

(Continued)

*Primary Examiner* — Mary Ann Calabrese  
*Assistant Examiner* — Katelin G Kloberg  
(74) *Attorney, Agent, or Firm* — Staas & Halsey LLP

(57) **CLAIM**

The ornamental design for a cross table, as shown and described.

**DESCRIPTION**

FIG. 1 is a top, front, right side perspective view of a cross table, showing my new design;  
FIG. 2 is a top, rear, left side perspective view thereof;  
FIG. 3 is a rear elevation view thereof;  
FIG. 4 is front elevation view thereof;  
FIG. 5 a left side elevation view thereof;  
FIG. 6 is a right side elevation view thereof;  
FIG. 7 is a top plan view thereof; and,  
FIG. 8 is a bottom plan view thereof.  
The broken lines shown in the drawings are for the purpose of illustrating portions of the supporting structure of the cross table that form no part of the claimed design.

**1 Claim, 8 Drawing Sheets**

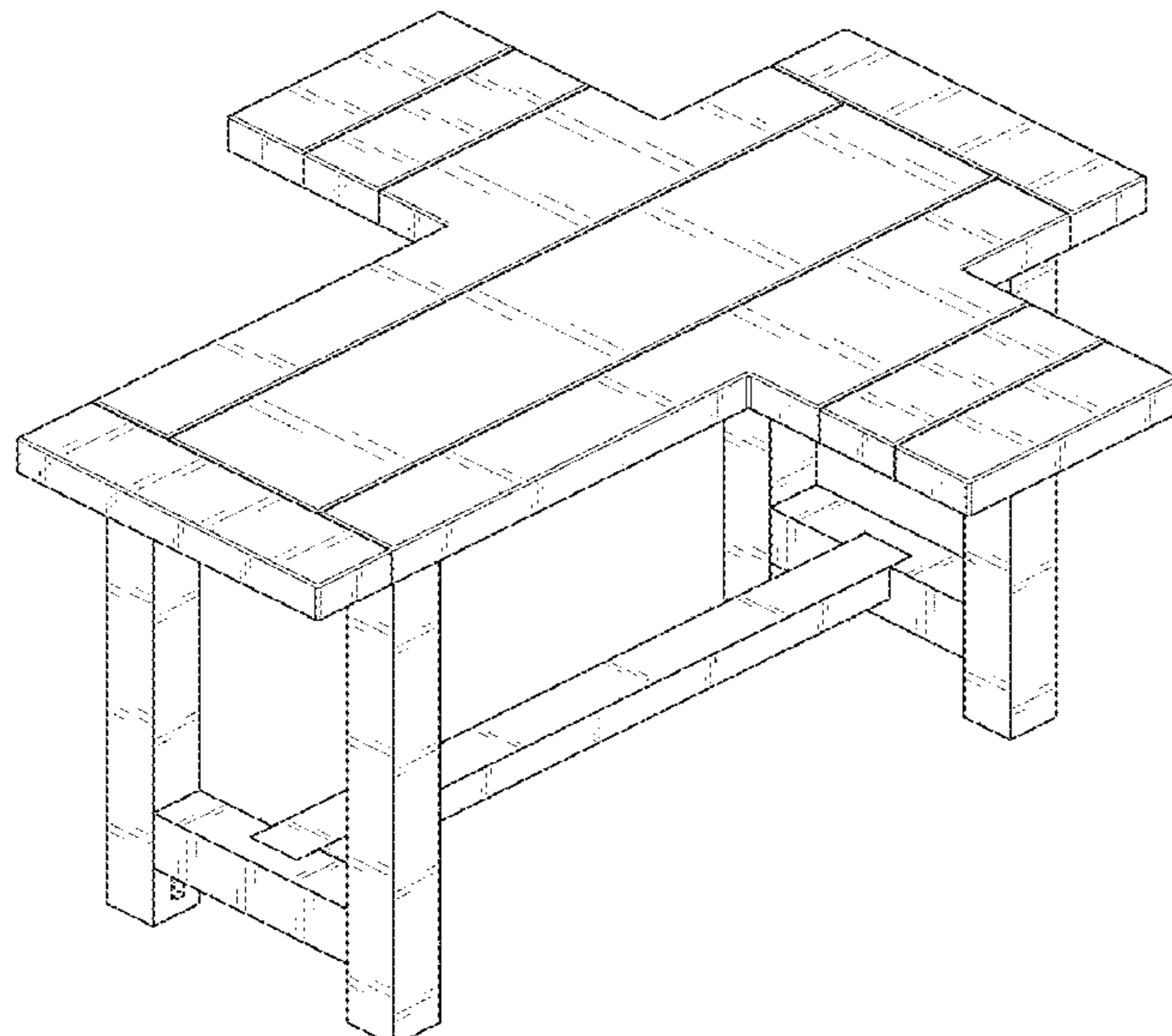

(56)

**References Cited**

U.S. PATENT DOCUMENTS

D757,464 S \* 5/2016 Chiang ..... D6/642  
D826,513 S \* 8/2018 Ditty ..... D99/27  
D916,424 S \* 4/2021 Hoag ..... D99/5

OTHER PUBLICATIONS

“Three Easy, Yet Memorable Table Layout Ideas to Dazzle Your Guests.” Found online Dec. 3, 2021 at [www.weven.co](http://www.weven.co). Page dated Jun. 12, 2020. Retrieved from URL: <https://weven.co/blog/wedding-floor-plans/> (Year: 2020).\*

“Making Your Wedding Reception Tables POP.” Found online Dec. 3, 2021 at [www.weddingvenuemap.com](http://www.weddingvenuemap.com). Page dated Jun. 5, 2018. Retrieved from URL: <https://weddingvenuemap.com/making-your-wedding-reception-tables-pop/>(Year: 2018).\*

“Antique Spanish Carved Church Table or Altar with Wood Stretchers.” Found online Dec. 3, 2021 at [www.pamono.com](http://www.pamono.com). Circa 1919. Retrieved from URL: <https://www.pamono.com/antique-spanish-carved-church-table-or-altar-with-wood-stretchers> (Year: 1919).\*

\* cited by examiner

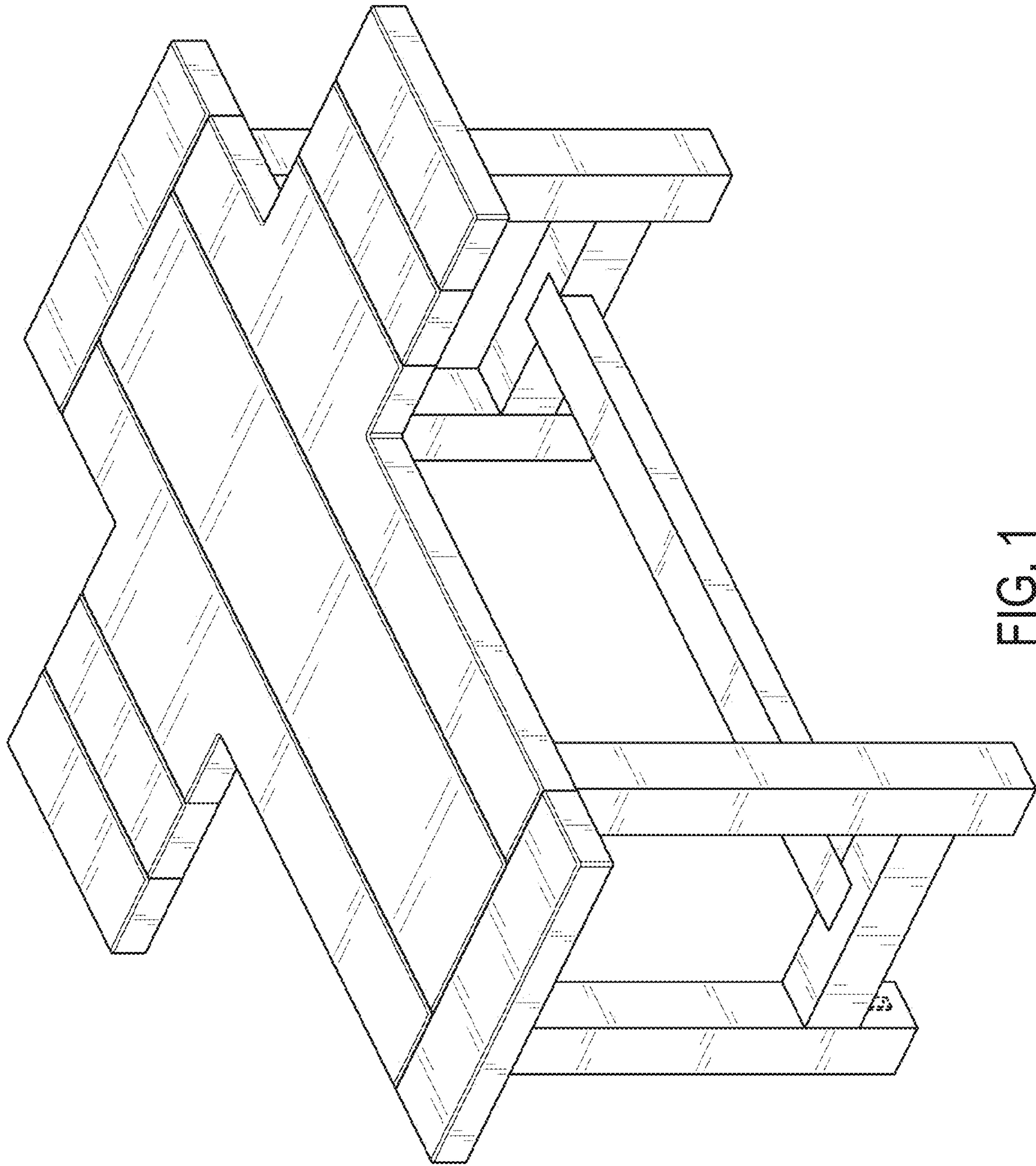

FIG. 1

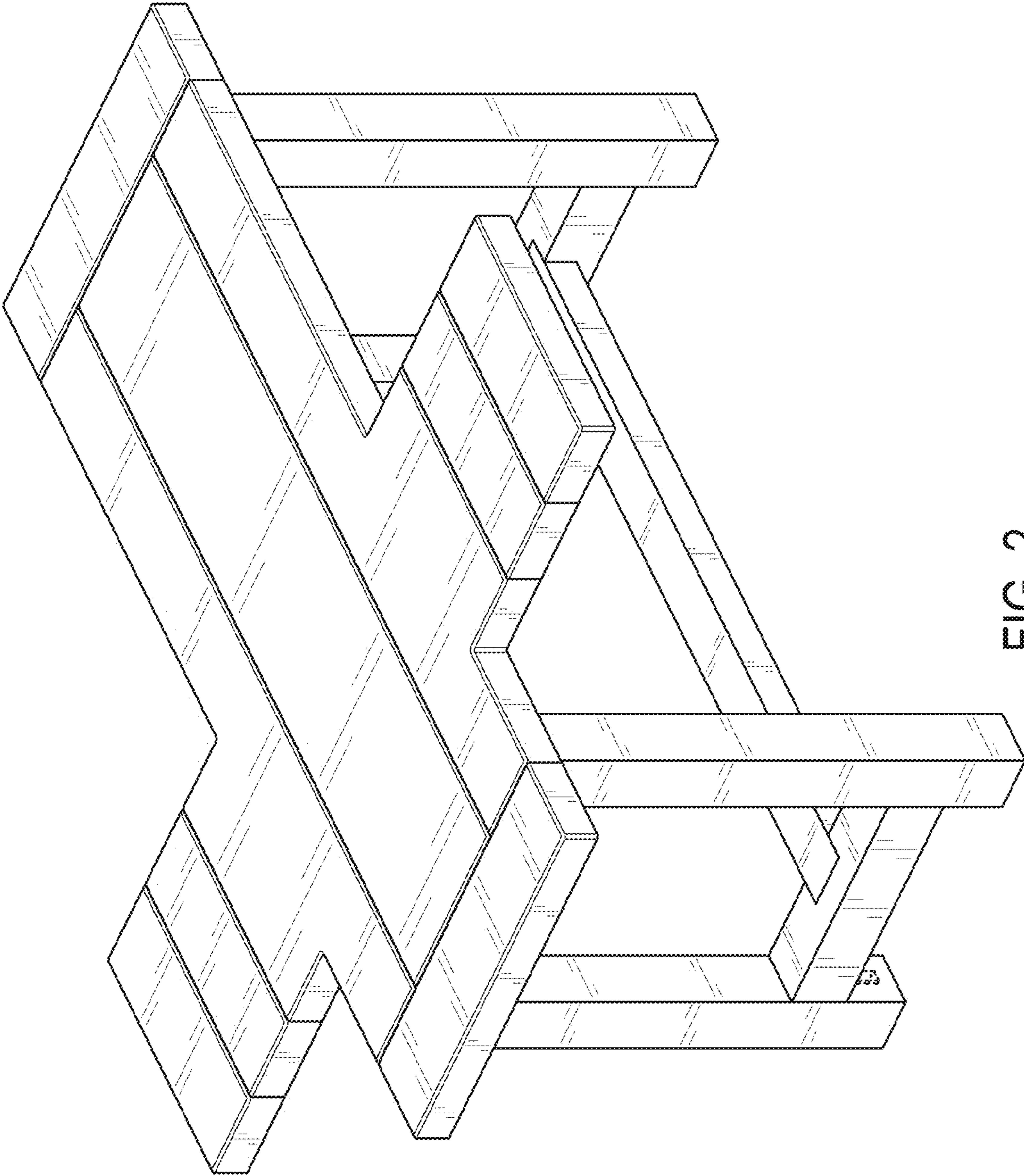

FIG. 2

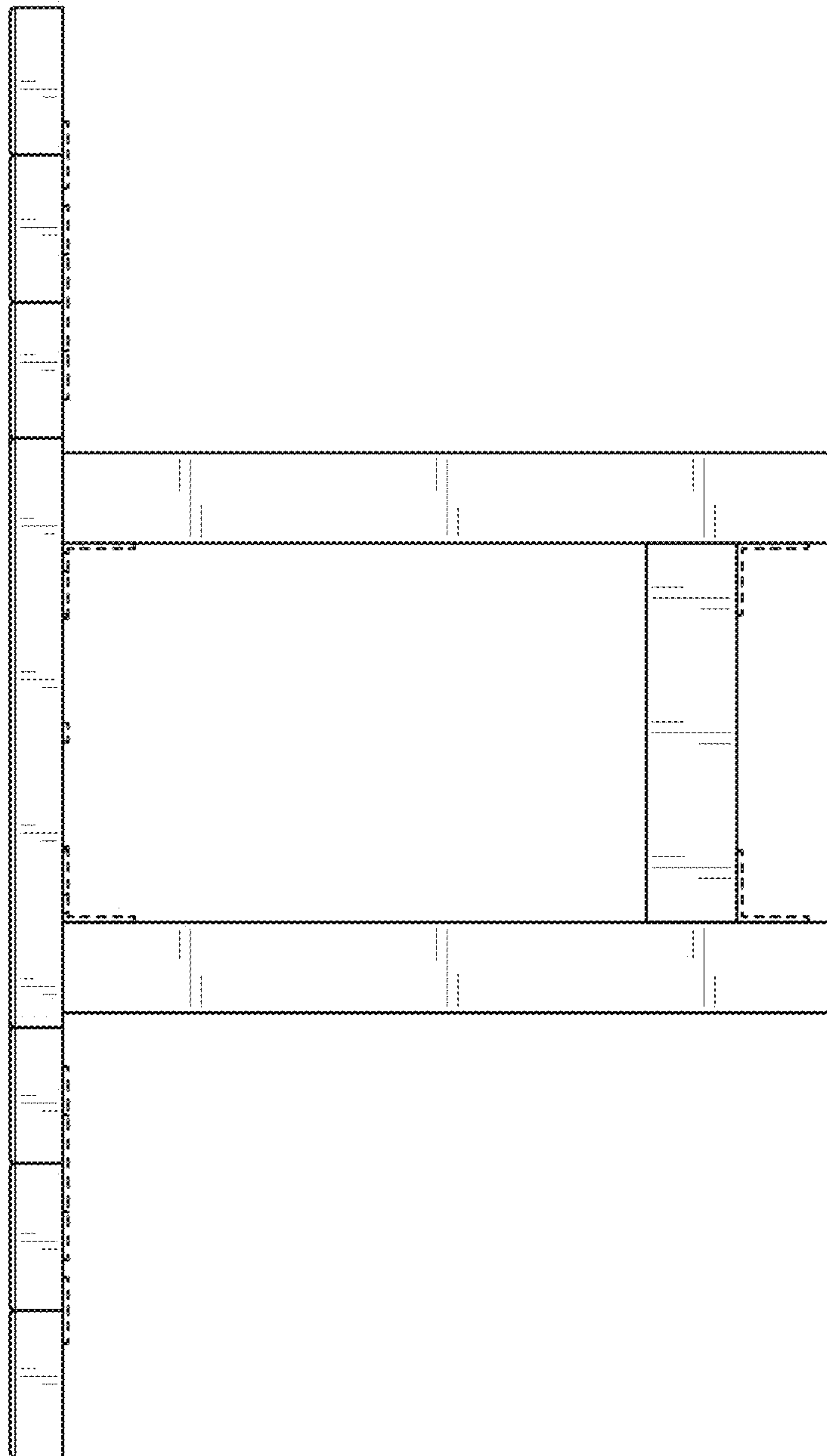

FIG. 3

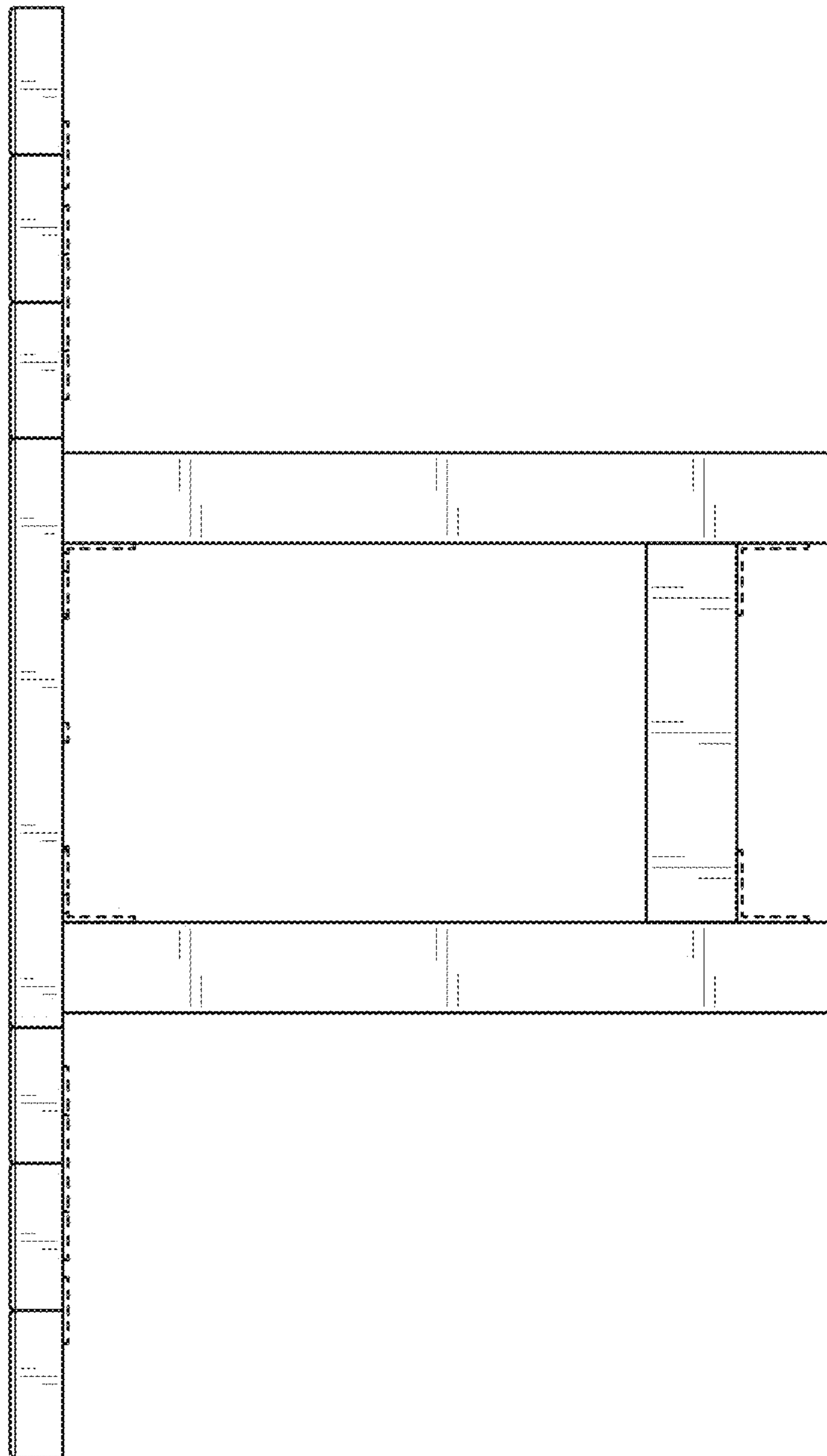

FIG. 4

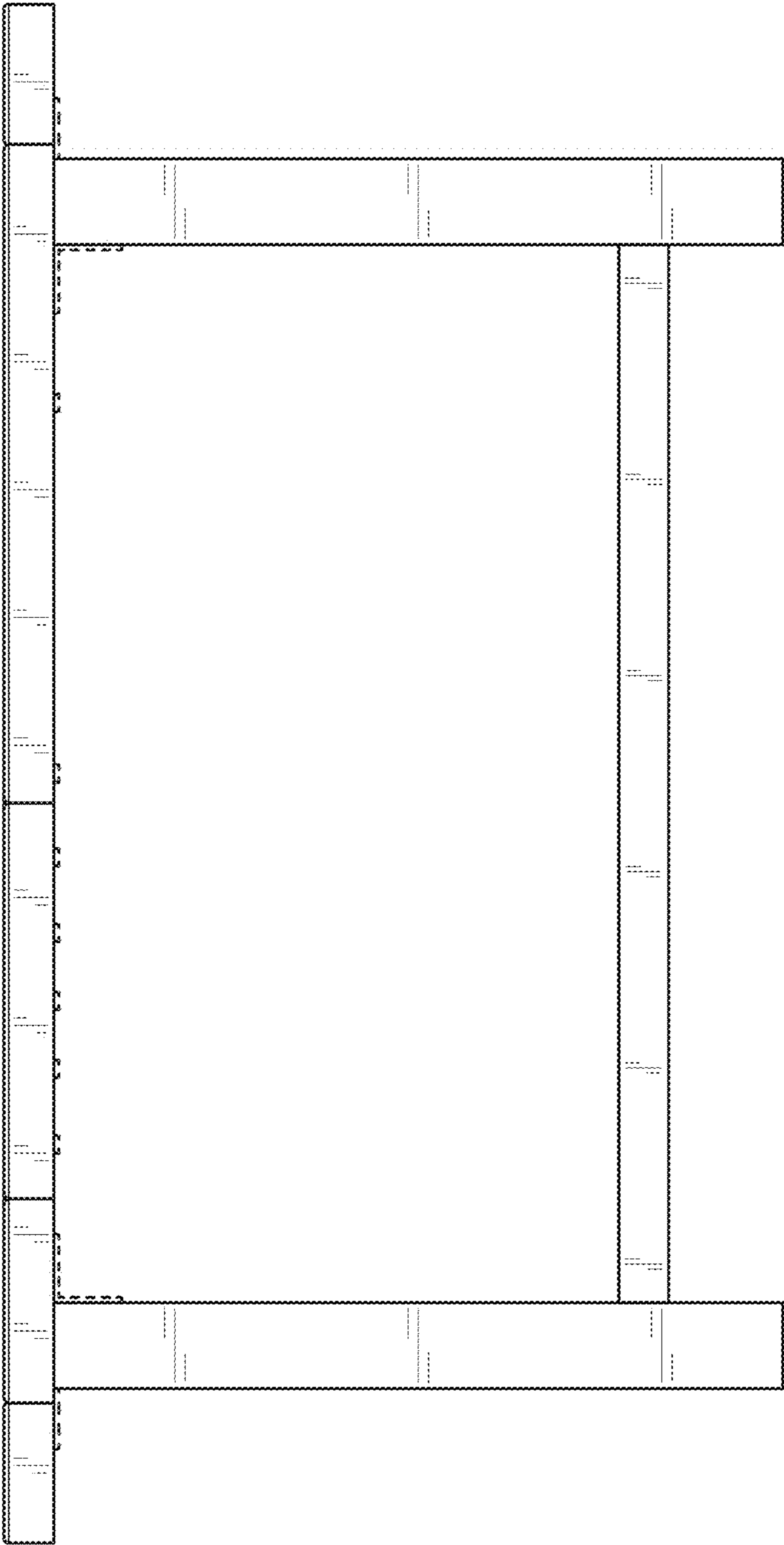

FIG. 5

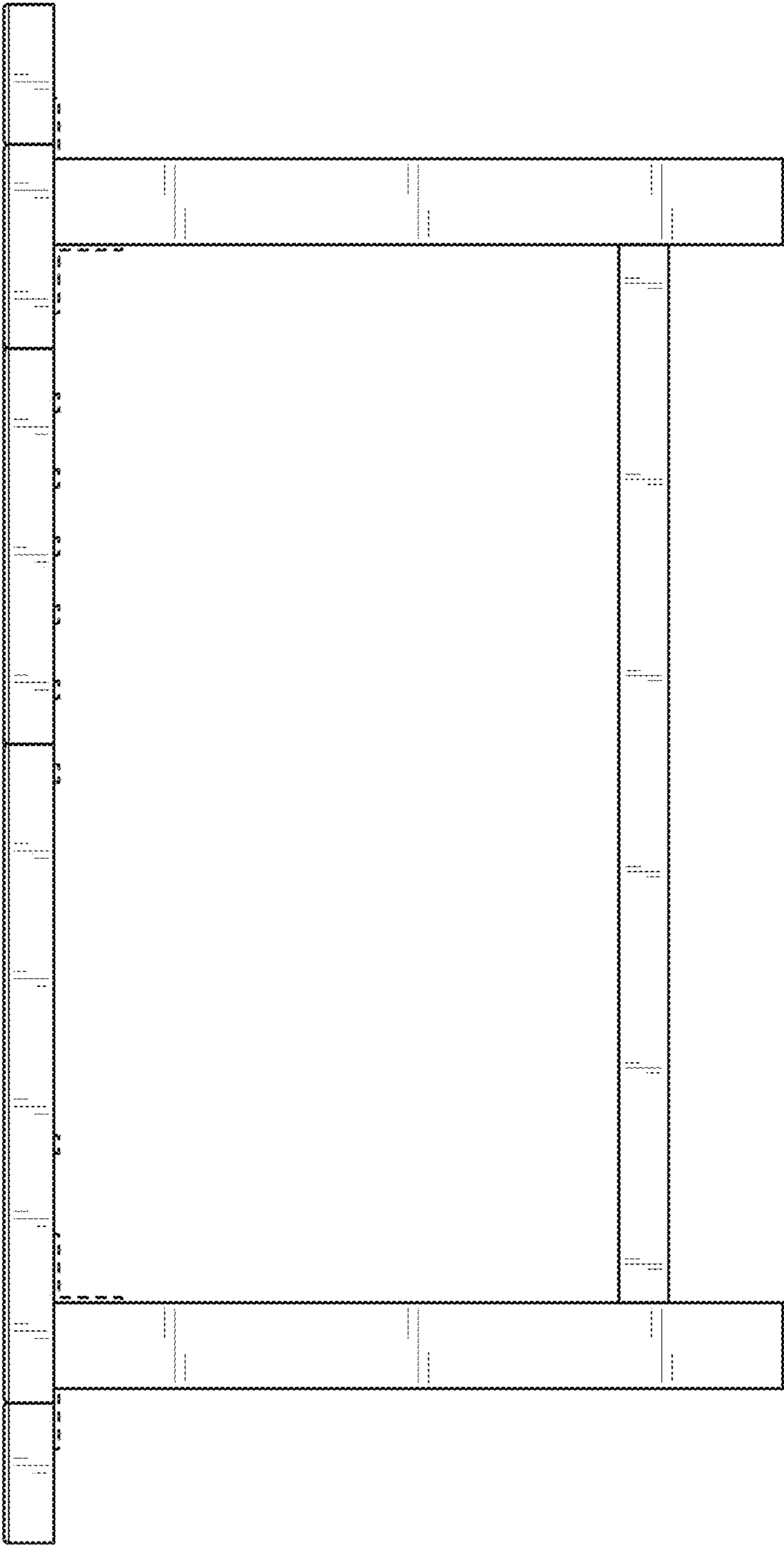

FIG. 6



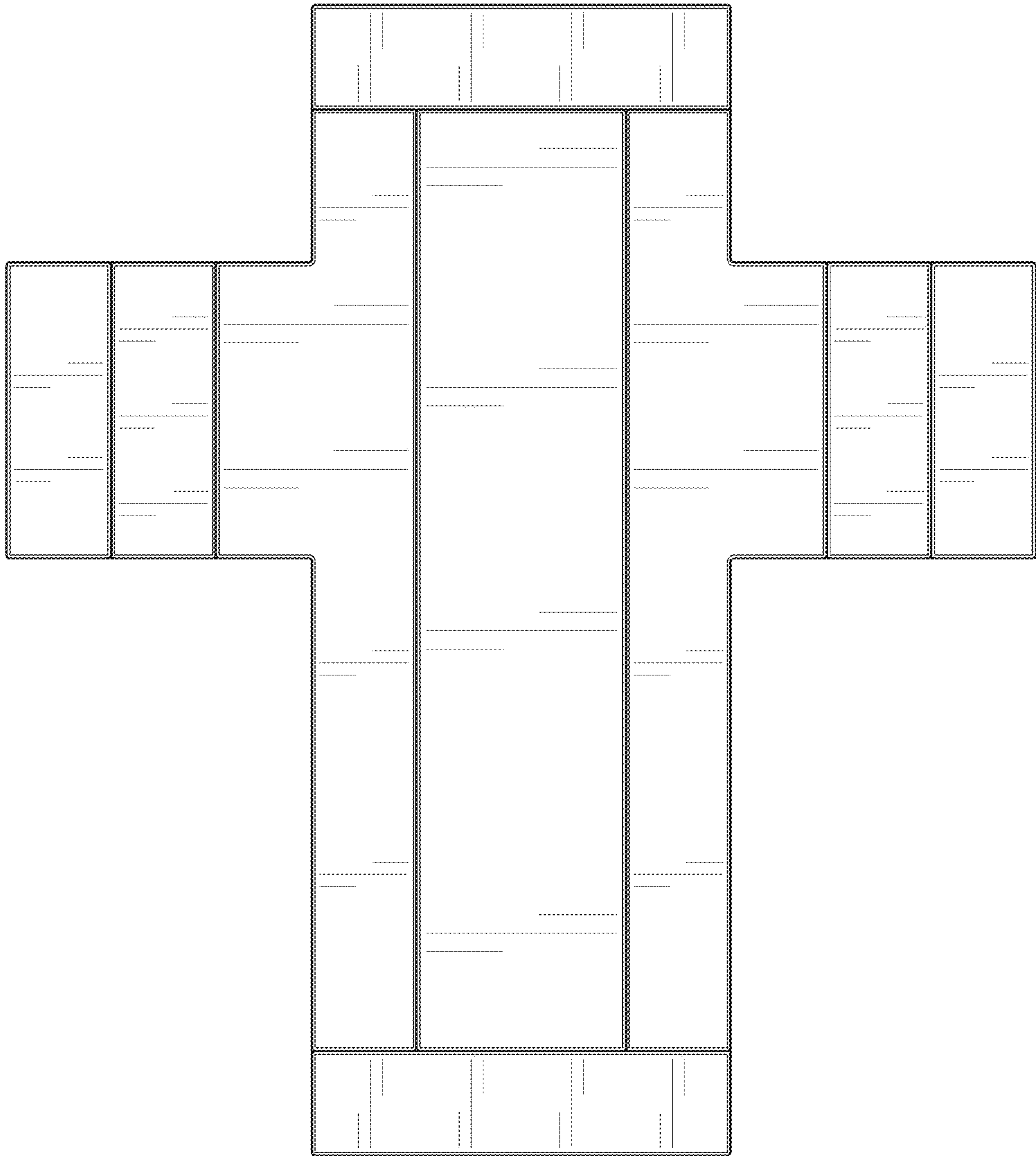

FIG. 7

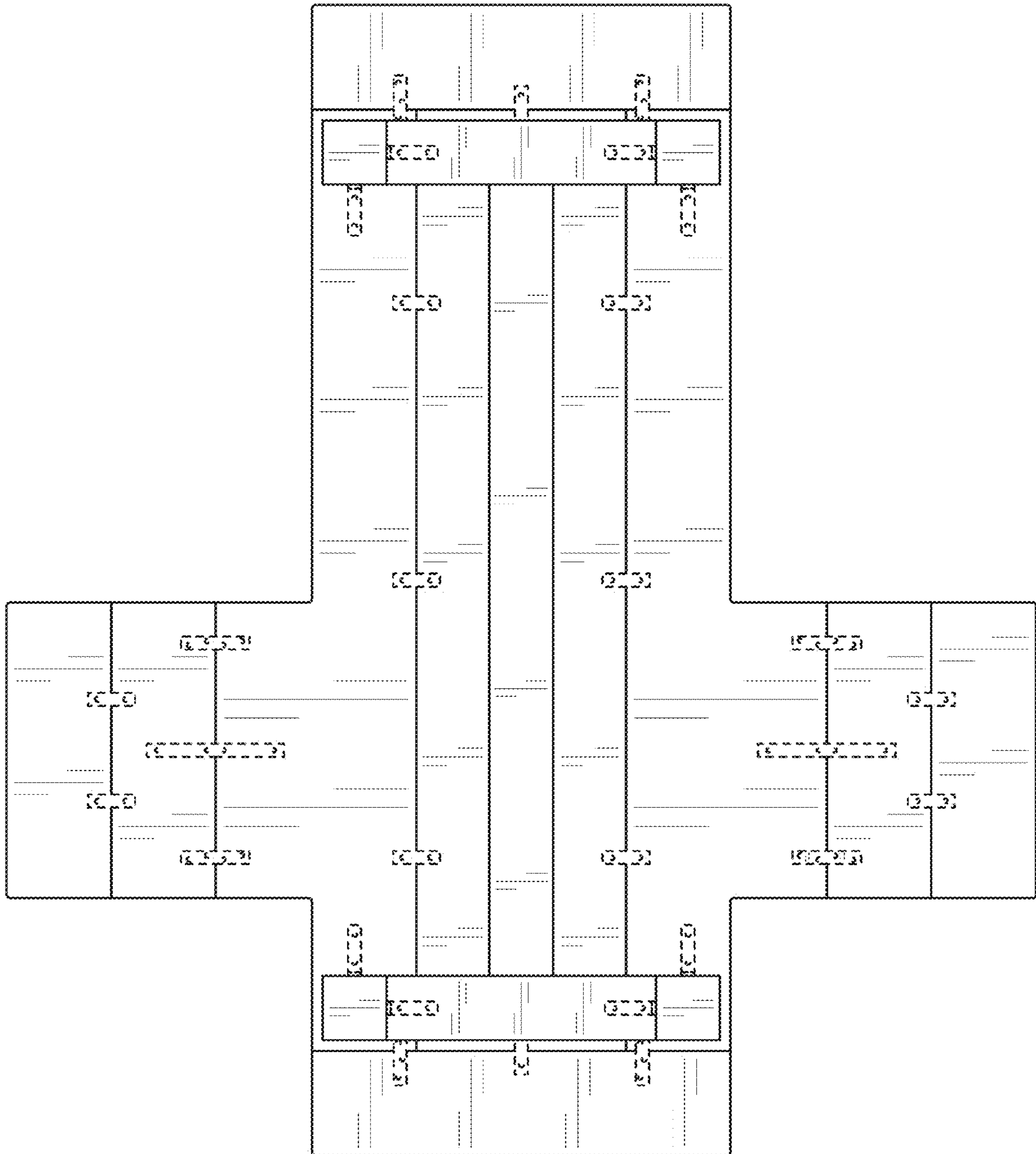

FIG. 8