



US00D945803S

(12) **United States Design Patent**
Yang et al.

(10) **Patent No.:** **US D945,803 S**
(45) **Date of Patent:** **** Mar. 15, 2022**

(54) **DISPLAY STAND**

(71) Applicant: **Apple Inc.**, Cupertino, CA (US)
(72) Inventors: **Sheng Yang**, Mountain View, CA (US);
Olivia M. Ching, Mountain View, CA (US); **Chien Tsun Chen**, Taipei (TW);
Eric Weijia Wang, Newark, CA (US); **Ricardo A. Mariano**, Hayward, CA (US);
Allison Inouye, San Francisco, CA (US); **Kristy Judy Hsu**, San Jose, CA (US);
Po Huang, San Jose, CA (US); **Jean-Marc Gady**, Los Altos, CA (US);
Peter Russell-Clarke, San Francisco, CA (US); **Daniele De Iuliis**, San Francisco, CA (US);
Jeremy Bataillou, San Francisco, CA (US); **Markus Diebel**, San Francisco, CA (US);
Rico Zörkendörfer, San Francisco, CA (US); **Molly Anderson**, San Francisco, CA (US);
Shota Aoyagi, San Francisco, CA (US); **Jody Akana**, San Francisco, CA (US)

(73) Assignee: **Apple Inc.**, Cupertino, CA (US)

(**) Term: **15 Years**

(21) Appl. No.: **29/807,507**

(22) Filed: **Sep. 13, 2021**

Related U.S. Application Data

(63) Continuation of application No. 29/758,623, filed on Nov. 17, 2020, now Pat. No. Des. 930,414, which is (Continued)

(51) **LOC (13) Cl.** **06-06**

(52) **U.S. Cl.**
USPC **D6/682.3**

(58) **Field of Classification Search**
USPC D6/672, 673, 512–513, 553, 682, 682.3;
D14/457; D8/354; D16/200–202, 203,
D16/208, 218, 219

(Continued)

(56) **References Cited**

U.S. PATENT DOCUMENTS

D214,768 S 7/1969 Hillis
D244,857 S 6/1977 Hayes
(Continued)

FOREIGN PATENT DOCUMENTS

JP D1430086 12/2011
KR 30-0337376 11/2003

OTHER PUBLICATIONS

“Freedom Series,” Takachiho Koheki Co., Ltd., cited in Office Action dated Apr. 6, 2016, in Japanese Patent Application No. 2015-009263, Apple Inc., filed Apr. 24, 2015.

Primary Examiner — Kelley A Donnelly
(74) *Attorney, Agent, or Firm* — Sterne, Kessler, Goldstein & Fox P.L.L.C.

(57) **CLAIM**

The ornamental design for a display stand, as shown and described.

DESCRIPTION

FIG. 1 is a top front perspective view of a display stand showing the claimed design;
FIG. 2 is a front view thereof;
FIG. 3 is a rear view thereof;
FIG. 4 is a left side view thereof;
FIG. 5 is a right side view thereof;
FIG. 6 is a top view thereof;
FIG. 7 is a bottom view thereof;
FIG. 8 is a top front perspective view thereof showing the claimed design in an environment in which it may be used; and,
FIG. 9 is a bottom rear perspective view thereof.
The dashed broken lines in the figures show portions of the display stand and environment that form no part of the claimed design.

1 Claim, 7 Drawing Sheets

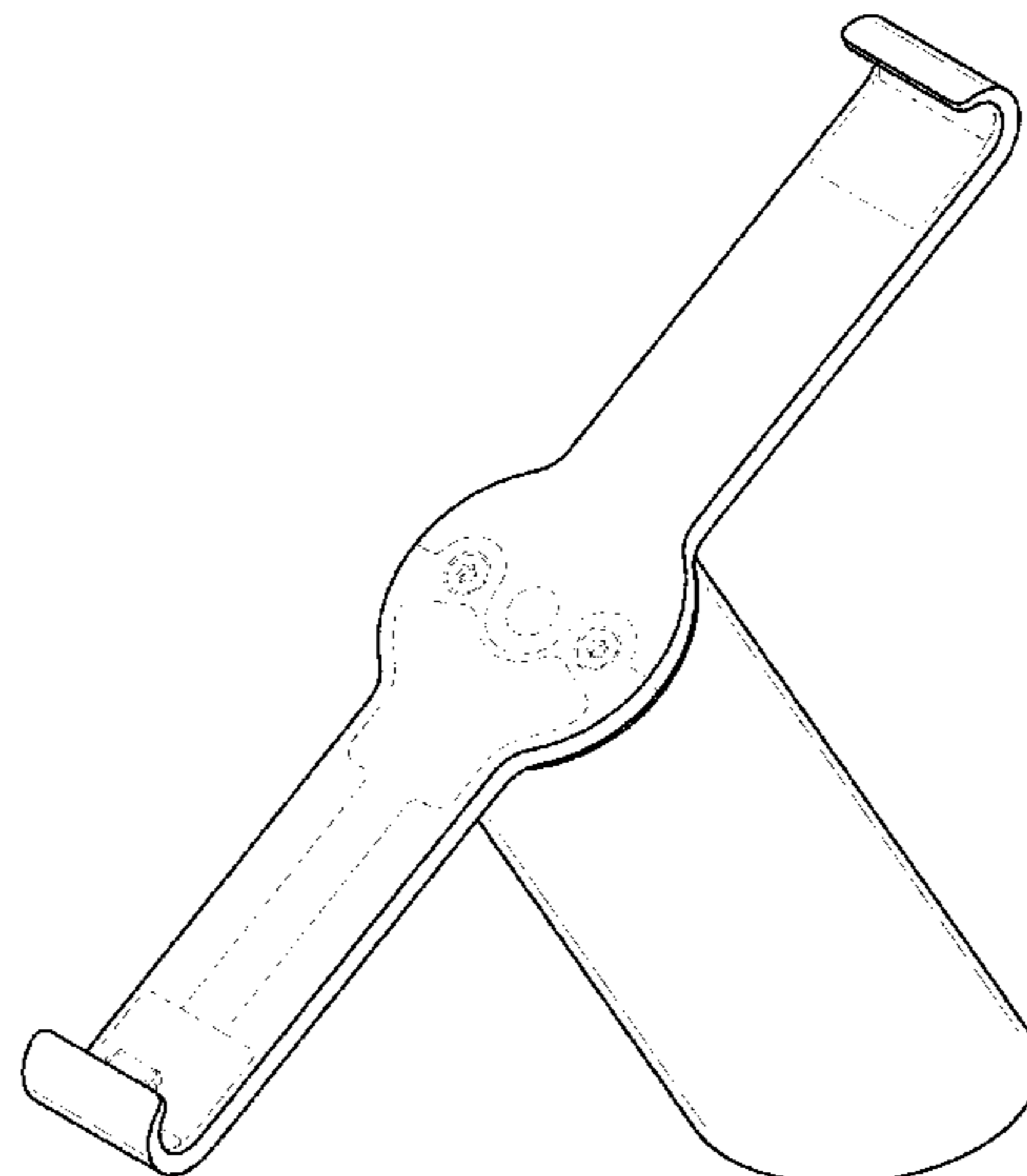

Related U.S. Application Data

a continuation of application No. 29/743,203, filed on Jul. 20, 2020, now Pat. No. Des. 904,091, which is a continuation of application No. 29/695,817, filed on Jun. 21, 2019, now Pat. No. Des. 893,926.

(58) **Field of Classification Search**

CPC A47B 2097/005; A47B 2097/006; A47F 5/0081; A47F 5/04; A47F 5/12

See application file for complete search history.

(56)

References Cited

U.S. PATENT DOCUMENTS

D250,801 S 1/1979 Bergen et al.
 D268,743 S 4/1983 Lubin
 D314,501 S 2/1991 Pagano
 D367,408 S 2/1996 Fordyce
 D393,959 S 5/1998 Geier et al.
 D407,408 S 3/1999 Hoff
 D413,035 S 8/1999 Weterrings et al.
 6,109,569 A 8/2000 Sakaida
 D446,043 S 8/2001 Stoppenhagen et al.
 6,476,717 B1 11/2002 Gross et al.
 D485,710 S 1/2004 Burkhart et al.
 D488,741 S 4/2004 Moya
 D490,559 S 5/2004 Small
 D510,358 S 10/2005 Ezure
 D510,822 S 10/2005 Spiers et al.
 7,209,038 B1 4/2007 Deconinck et al.
 D542,279 S 5/2007 Chan
 D545,826 S 7/2007 Richter
 D588,438 S 3/2009 Keller
 D589,962 S 4/2009 Maruyama et al.
 D590,184 S 4/2009 Barabas et al.
 D592,188 S * 5/2009 Huang D14/217
 D599,241 S 9/2009 Andre et al.
 D608,718 S 1/2010 Nas et al.
 D612,837 S 3/2010 Murray
 7,724,135 B2 5/2010 Rapp et al.
 D617,383 S 6/2010 Yoon
 7,740,214 B2 6/2010 Marsilio et al.
 7,748,669 B2 7/2010 Lu et al.
 D628,203 S 11/2010 Noble
 D629,405 S 12/2010 Crysell
 D633,973 S 3/2011 Ringl
 D641,610 S 7/2011 Sedalo
 D645,047 S 9/2011 Wike
 8,020,816 B2 9/2011 Laitila et al.
 D647,726 S 11/2011 Strauch
 D652,422 S 1/2012 Cheng
 8,087,625 B2 1/2012 Chang
 8,145,821 B2 3/2012 Mead et al.
 D663,972 S 7/2012 Alexander et al.
 D669,481 S * 10/2012 Prescott D14/447
 D673,960 S 1/2013 Lindfield et al.
 D681,974 S 5/2013 Naples et al.
 D682,814 S 5/2013 Kadivar et al.
 D685,253 S 7/2013 Hiebert
 D685,806 S 7/2013 Kim et al.
 D687,440 S 8/2013 Shieh

D695,714 S 12/2013 Lee
 D696,259 S 12/2013 Howarth et al.
 D696,674 S 12/2013 Vogel
 D703,657 S 4/2014 Camevali
 D704,199 S 5/2014 Byun
 D709,066 S 7/2014 Byun
 D709,357 S 7/2014 Bell
 D709,607 S 7/2014 Wang
 D720,752 S 1/2015 Bleads
 D721,510 S 1/2015 Hagerty
 D728,576 S 5/2015 David et al.
 D729,043 S 5/2015 Poppell
 D731,496 S 6/2015 Voorhees
 D733,967 S 7/2015 Schlatter
 D734,746 S 7/2015 Vogel
 D735,162 S 7/2015 Allen
 D737,081 S 8/2015 Schwalbach et al.
 D741,093 S 10/2015 McKinney et al.
 D743,941 S 11/2015 Patsis
 D744,621 S 12/2015 Shavatt et al.
 D756,152 S 5/2016 Schwalbach et al.
 D763,263 S 8/2016 Wierenga
 D764,478 S 8/2016 Radmard
 D769,852 S 10/2016 Godycki et al.
 D771,614 S 11/2016 Chang
 D775,874 S 1/2017 Huang
 D789,373 S 6/2017 King
 D792,133 S * 7/2017 Schwalbach D6/682.3
 D798,636 S 10/2017 Van Landingham, Jr.
 D803,208 S 11/2017 Cai
 D803,840 S 11/2017 Burmester
 D806,455 S 1/2018 Hendren
 D835,440 S 12/2018 Schwalbach et al.
 D837,223 S 1/2019 Wu et al.
 D841,373 S 2/2019 Akana et al.
 D879,519 S 3/2020 Schwalbach et al.
 D893,926 S * 8/2020 Yang D6/682.3
 D904,091 S * 12/2020 Yang D6/682.3
 D920,984 S * 6/2021 Howarth D14/447
 D930,414 S * 9/2021 Yang D6/682.3
 D934,229 S * 10/2021 Chapuis D14/253
 2004/0084579 A1 5/2004 Lee et al.
 2006/0198692 A1 9/2006 Petit
 2007/0145210 A1 * 6/2007 Fawcett F16M 11/00
 248/176.1
 2009/0218240 A1 9/2009 Allen et al.
 2011/0047844 A1 3/2011 Fawcett et al.
 2011/0068919 A1 3/2011 Rapp et al.
 2011/0084838 A1 4/2011 Fawcett
 2011/0187531 A1 8/2011 Oehl et al.
 2012/0188082 A1 7/2012 Berglund et al.
 2012/0280810 A1 11/2012 Wheeler
 2014/0106608 A1 * 4/2014 Howarth A47F 7/0246
 439/531
 2014/0138419 A1 5/2014 Minn et al.
 2015/0021458 A1 1/2015 Zorovich et al.
 2015/0300050 A1 * 10/2015 Van Balen A47F 5/0087
 248/551
 2017/0049251 A1 * 2/2017 Gulick, Jr. A47F 7/0246
 2020/0141159 A1 * 5/2020 Berglund A47F 5/02
 2021/0018137 A1 * 1/2021 Chapuis F16M 13/02

* cited by examiner

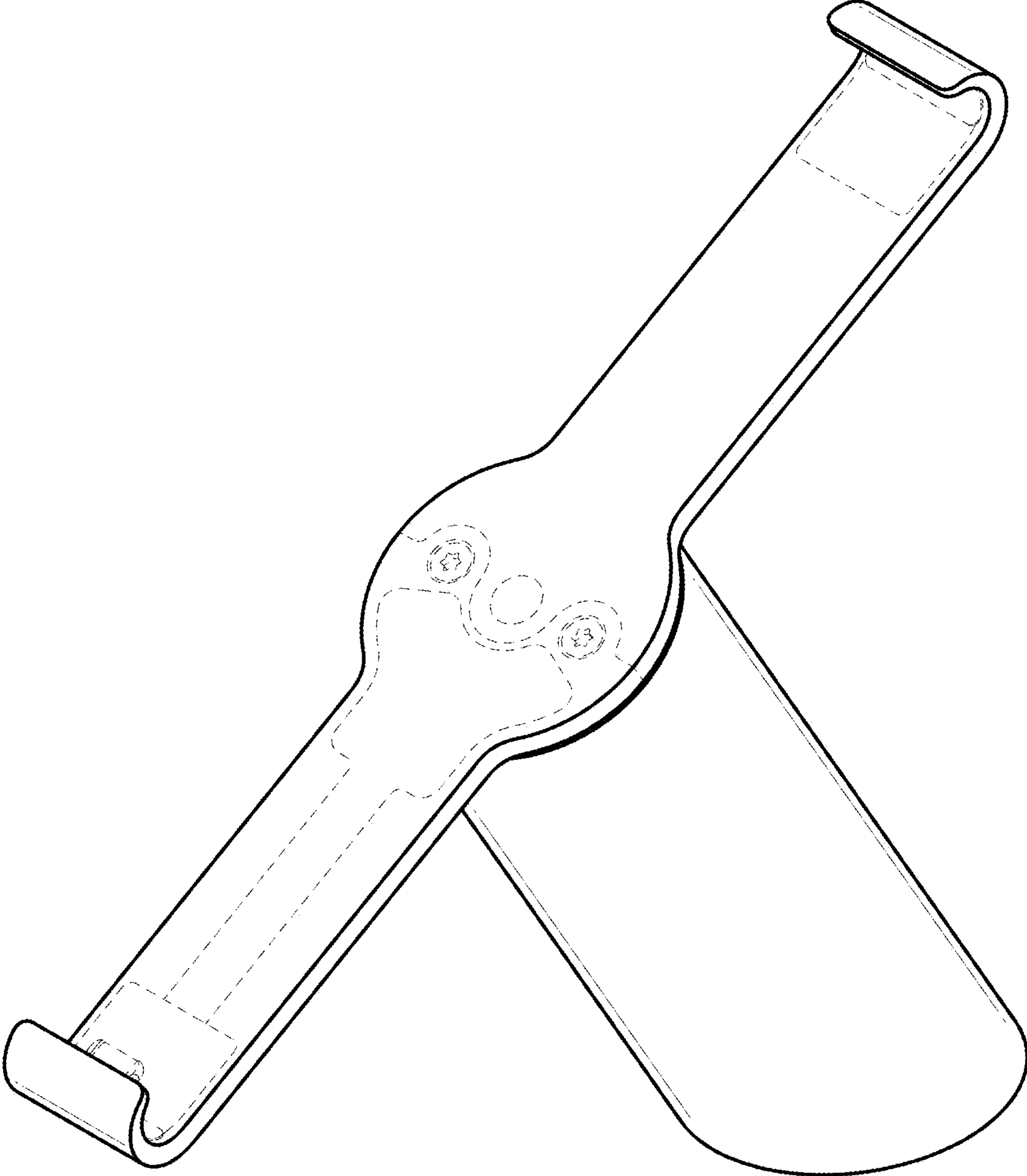

FIG. 1

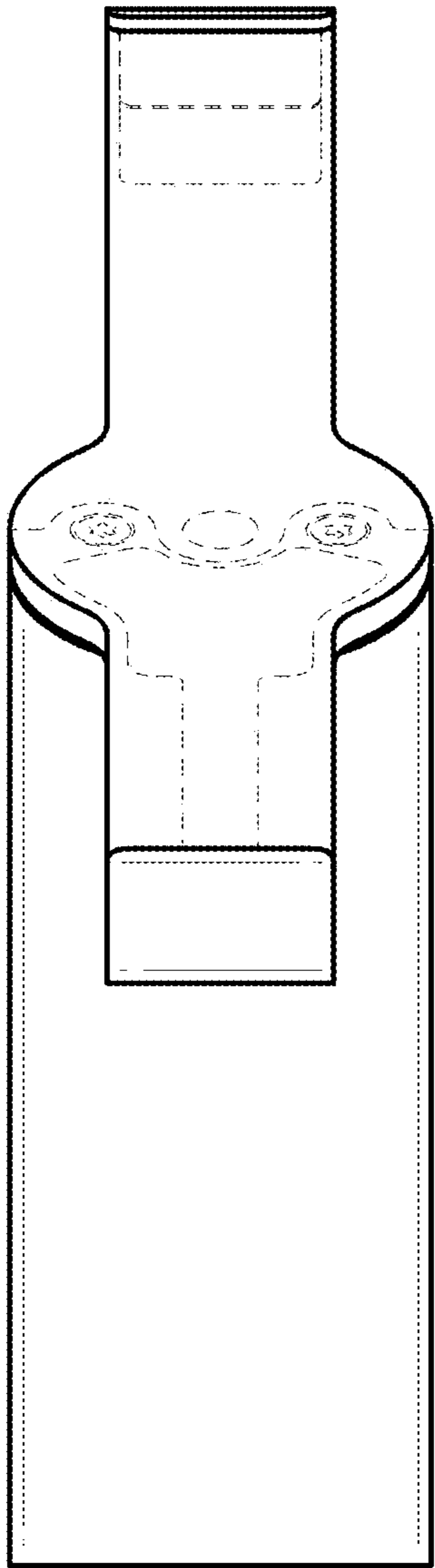

FIG. 2

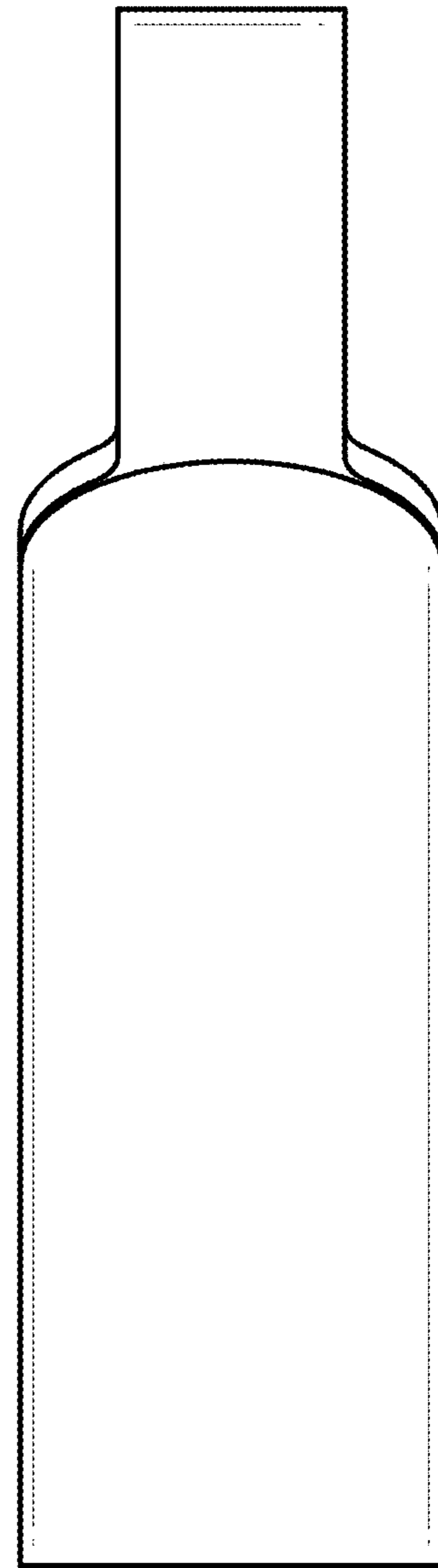

FIG. 3

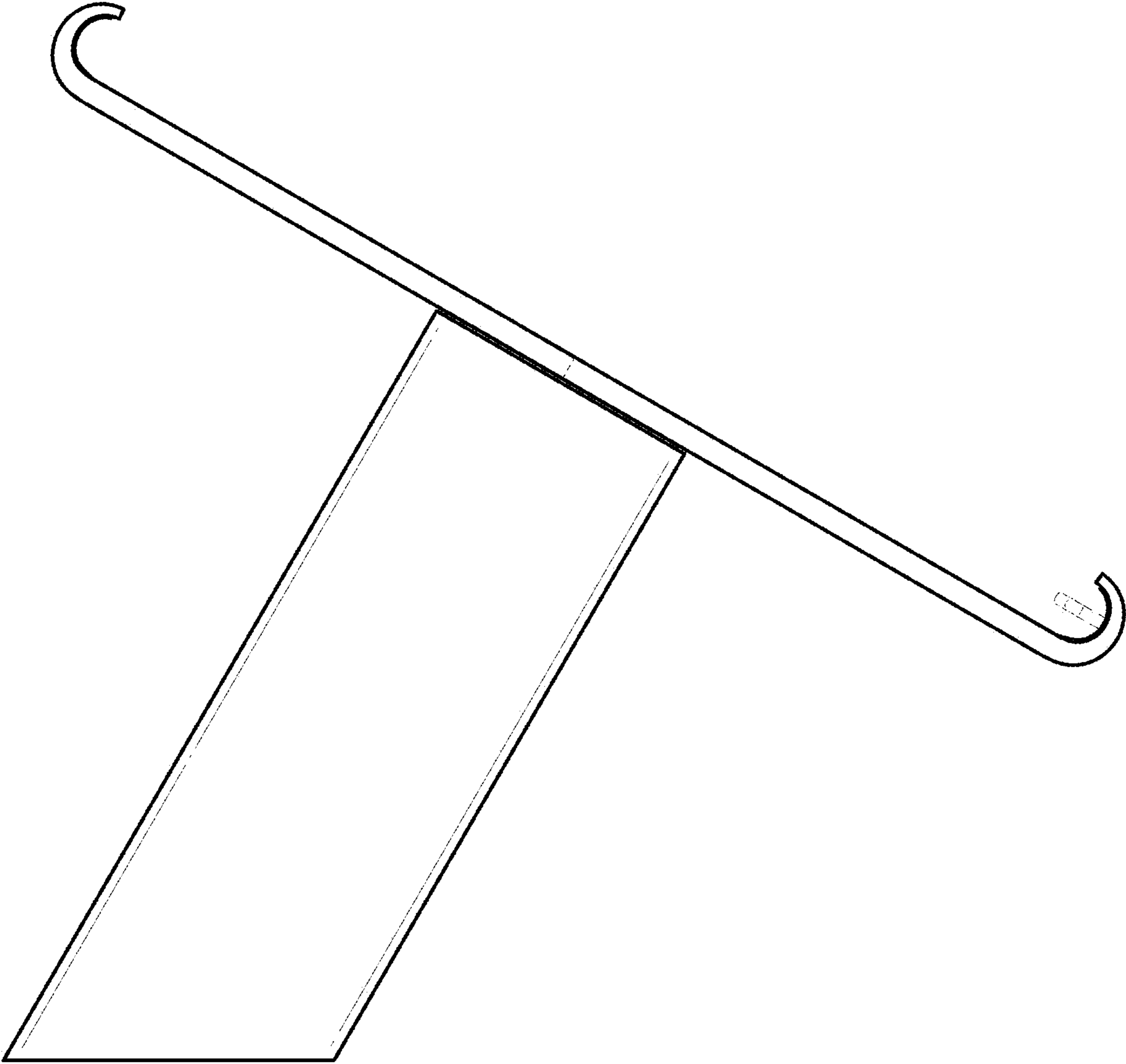

FIG. 4

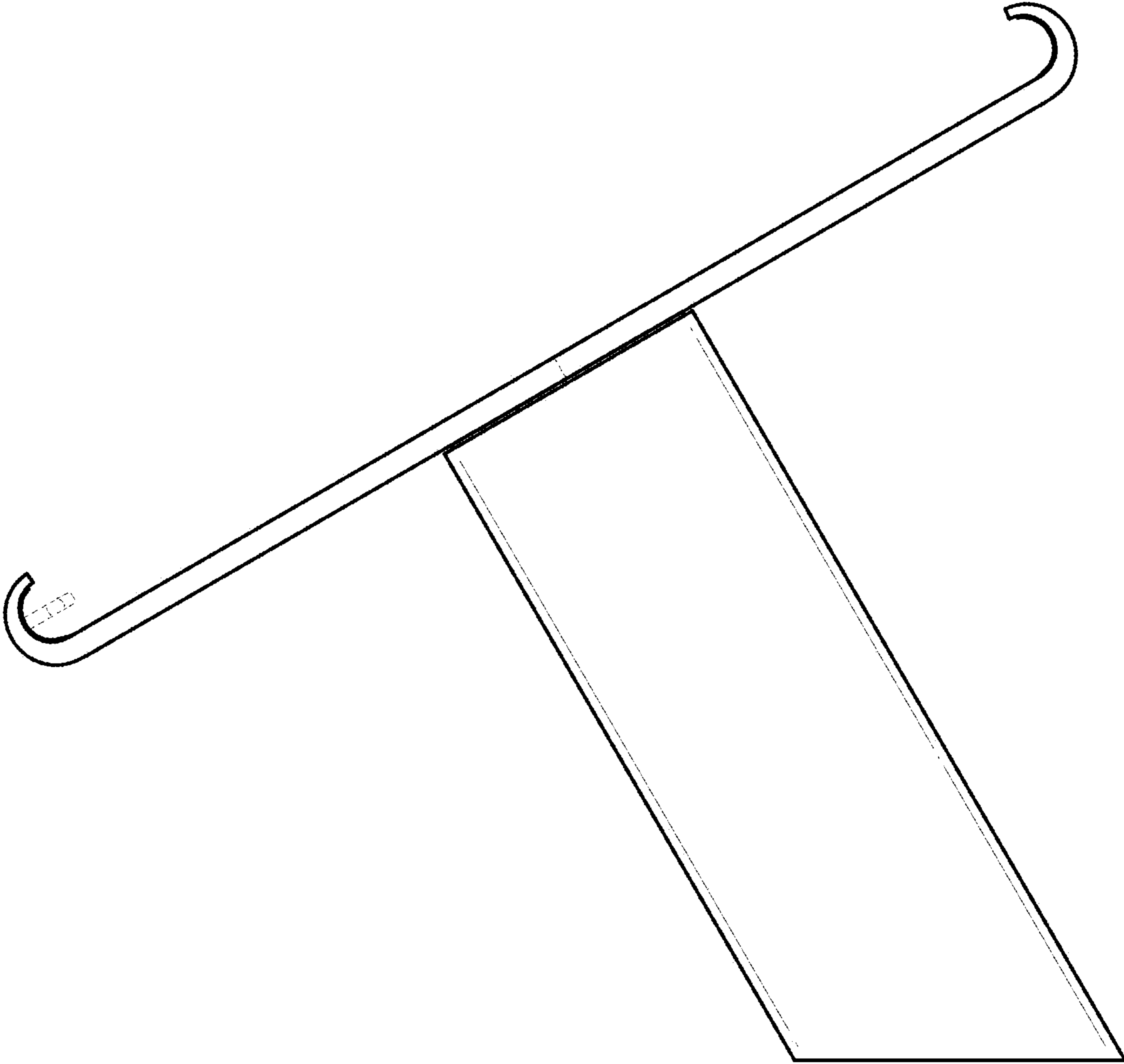

FIG. 5

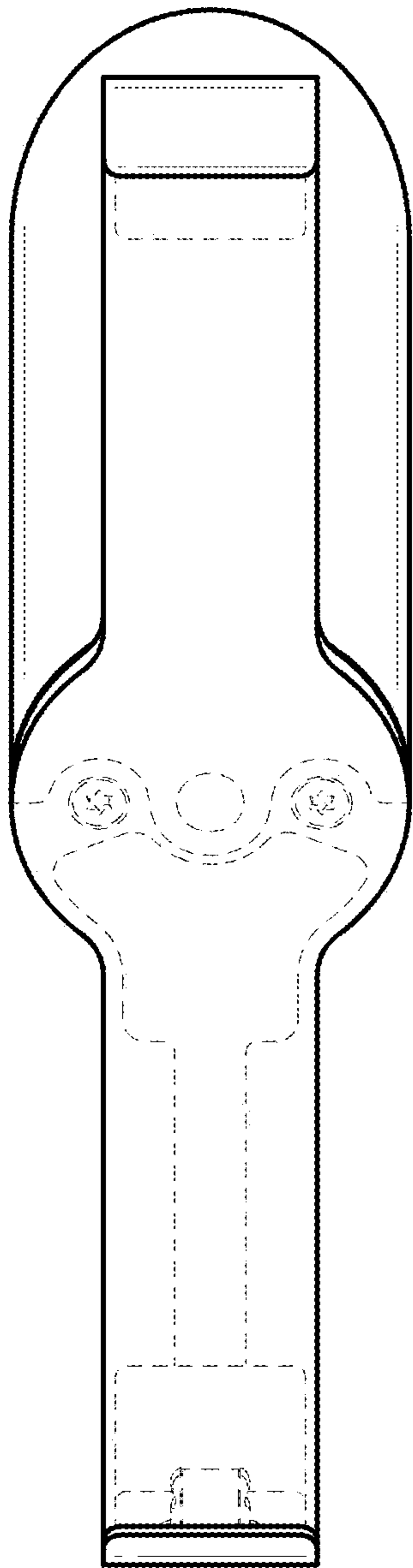

FIG. 6

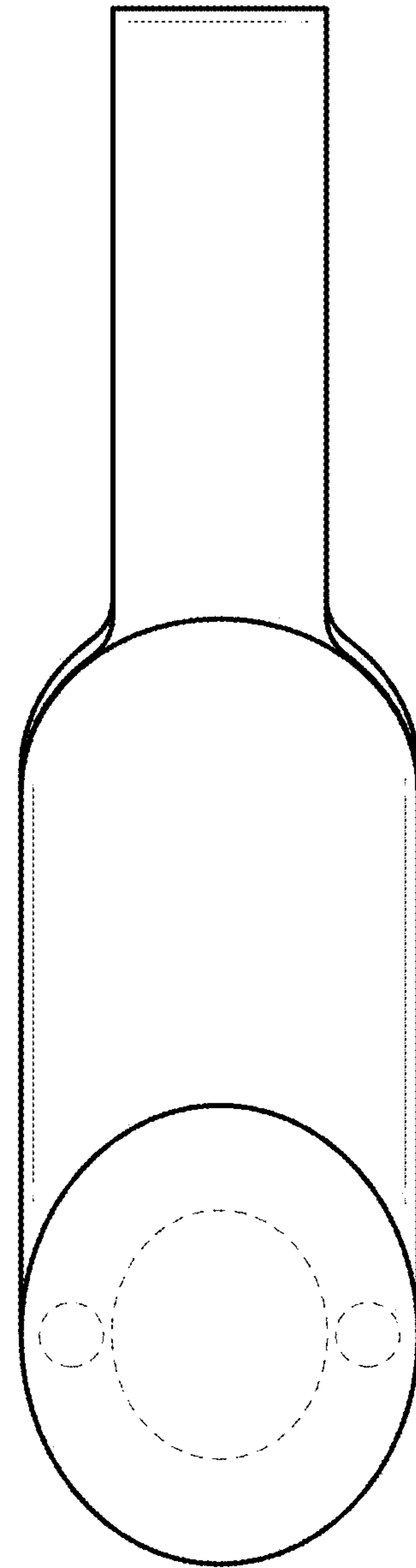

FIG. 7



FIG. 8

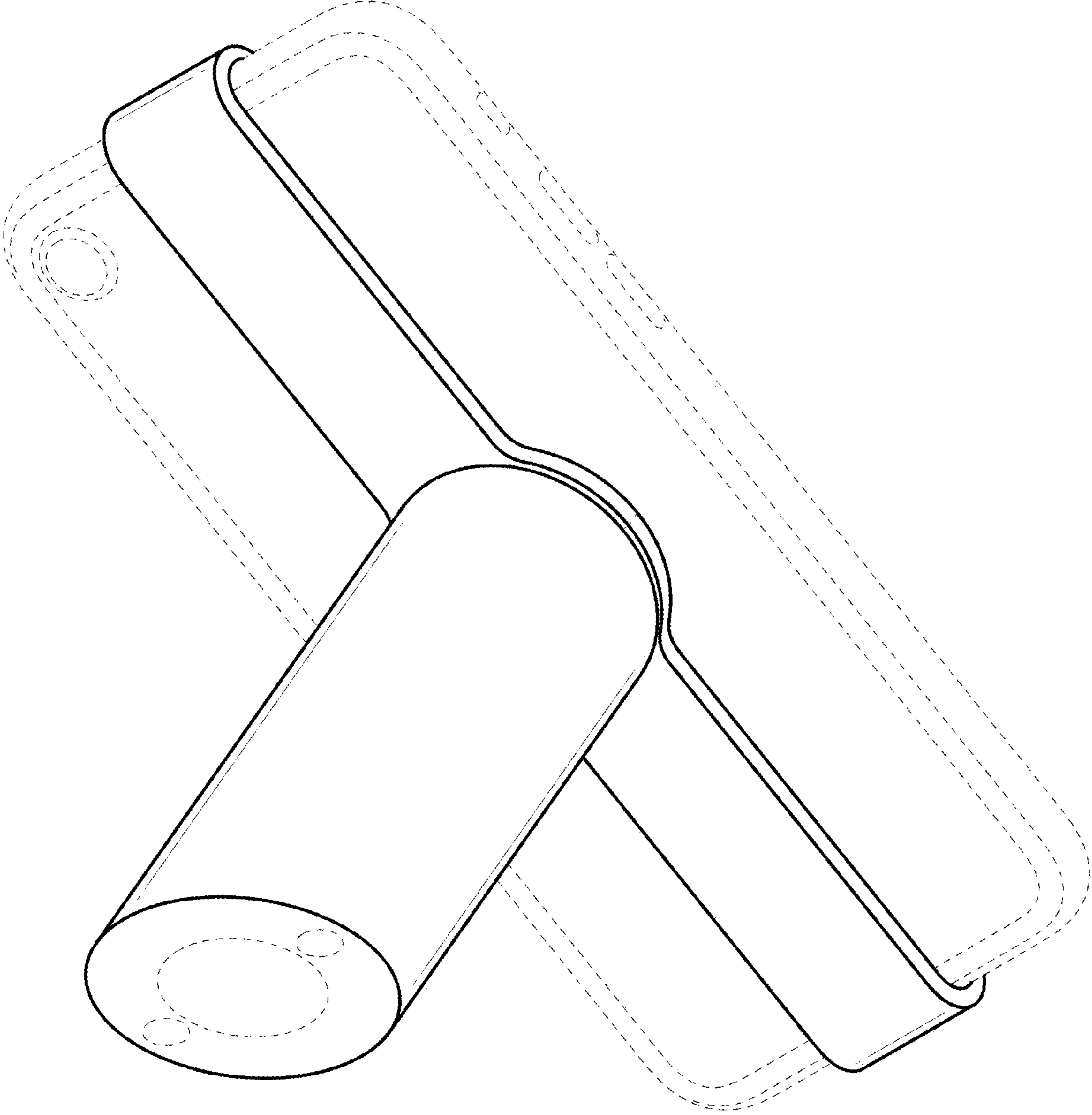

FIG. 9