



US00D945772S

(12) **United States Design Patent**
Dai

(10) **Patent No.:** **US D945,772 S**

(45) **Date of Patent:** **** Mar. 15, 2022**

(54) **SET OF CONTAINERS**

(71) Applicant: **ShenZhen YiHong Technology Co., LTD**, Guangdong (CN)

(72) Inventor: **Yi Dai**, ShenZhen (CN)

(73) Assignee: **ShenZhen YiHong Technology CO., LTD**, ShenZhen (CN)

(**) Term: **15 Years**

(21) Appl. No.: **29/782,334**

(22) Filed: **May 6, 2021**

(51) **LOC (13) Cl.** **03-01**

(52) **U.S. Cl.**
USPC **D3/304**

(58) **Field of Classification Search**
USPC D6/304, 305, 307, 308, 309, 310;
D32/37
CPC B65D 81/3813; B65D 21/00; B65D 1/00;
B65D 1/22; B65D 21/0233; A47J 47/00;
A47J 47/16; A47F 3/14
See application file for complete search history.

(56) **References Cited**

U.S. PATENT DOCUMENTS

D530,919 S *	10/2006	Snell	D3/304
D530,920 S *	10/2006	Snell	D3/304
D530,921 S *	10/2006	Snell	D3/304
D547,064 S *	7/2007	Snell	D3/304
D551,453 S *	9/2007	Snell	D3/304
D555,904 S *	11/2007	Snell	D3/304
D591,510 S *	5/2009	Auer	D3/304
D612,608 S	3/2010	Snell		
D682,036 S	5/2013	Filbrun		
D713,146 S *	9/2014	Ghiorghie	D3/304

(Continued)

Primary Examiner — Kelley A Donnelly

(74) *Attorney, Agent, or Firm* — iPA & iPM

(57) **CLAIM**

The ornamental design for a set of containers, as shown and described.

DESCRIPTION

FIG. 1 is a perspective view of a set of containers showing my new design;
 FIG. 2 is a perspective view of a first container among the set;
 FIG. 3 is a top view thereof;
 FIG. 4 is a left side view thereof;
 FIG. 5 is a front view thereof;
 FIG. 6 is a back view thereof;
 FIG. 7 is a right side view thereof; and
 FIG. 8 is a bottom view thereof;
 FIG. 9 is a perspective view of a second container among the set;
 FIG. 10 is a front view thereof;
 FIG. 11 is a left side view thereof;
 FIG. 12 is a right side view thereof;
 FIG. 13 is a back view thereof;
 FIG. 14 is a top view thereof; and
 FIG. 15 is a bottom view thereof;
 FIG. 16 is a perspective view of a third container among the set;
 FIG. 17 is a front view thereof;
 FIG. 18 is a right side view thereof;
 FIG. 19 is a left side view thereof;
 FIG. 20 is a back view thereof;
 FIG. 21 is a top view thereof; and
 FIG. 22 is a bottom view thereof;
 FIG. 23 is a perspective view of a fourth container among the set;
 FIG. 24 is a left side view thereof;
 FIG. 25 is a right side view thereof;
 FIG. 26 is a front view thereof;
 FIG. 27 is a back view thereof;
 FIG. 28 is a top view thereof; and,
 FIG. 29 is a bottom view thereof.

1 Claim, 15 Drawing Sheets

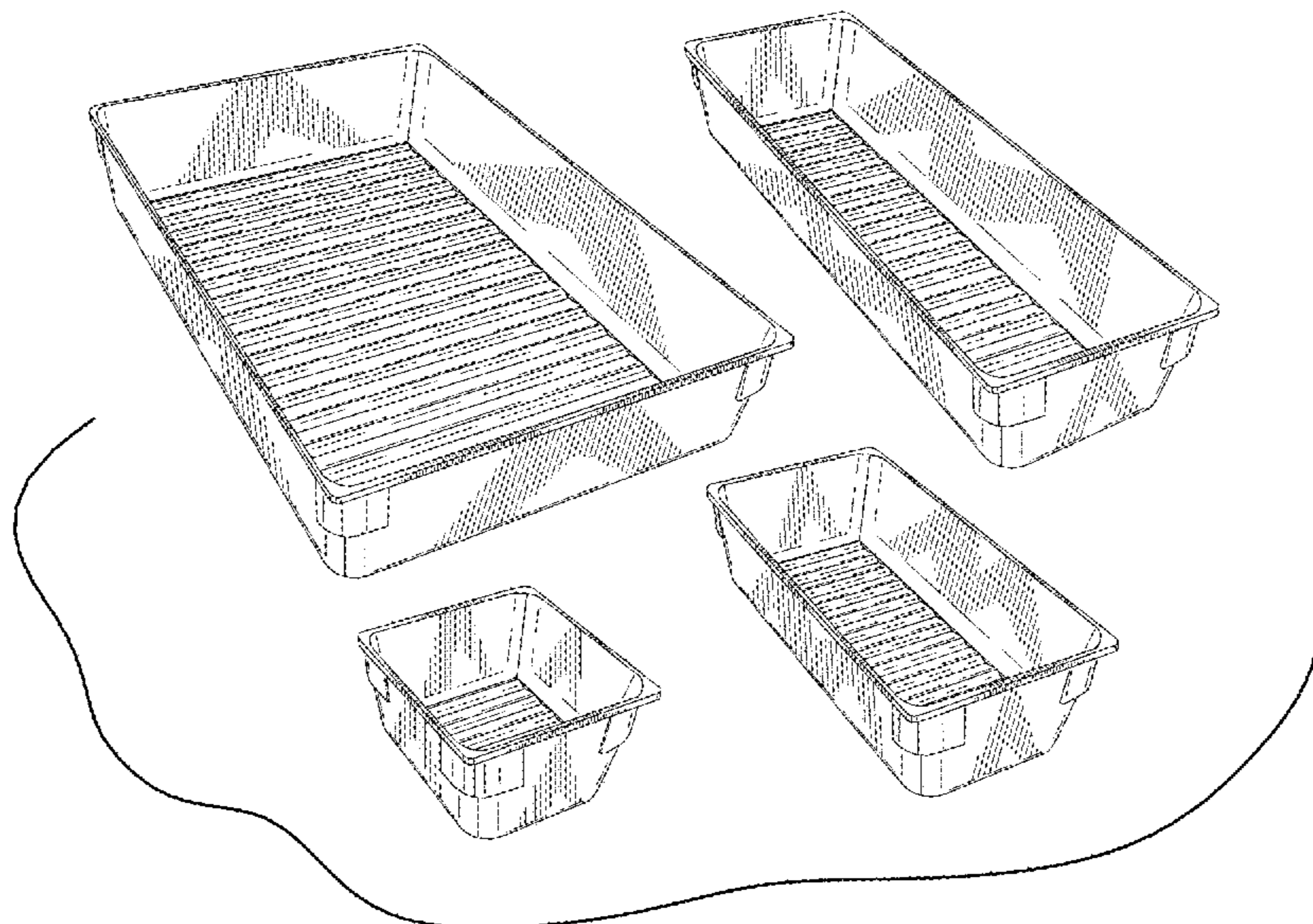

(56)

References Cited

U.S. PATENT DOCUMENTS

D750,892 S	3/2016	Rego	
D806,391 S *	1/2018	Ghiorghie	D3/304
D812,910 S	3/2018	Harvey	
D819,971 S	6/2018	Lindsay et al.	
D848,188 S	5/2019	Holm	
D872,482 S	1/2020	Harvey	
D876,836 S	3/2020	Stevens	
D891,879 S	8/2020	Adams, Jr. et al.	
D903,322 S *	12/2020	Zhang	D3/304
D908,435 S	1/2021	Luan	
D922,073 S *	6/2021	Dittrich	D3/314
D938,726 S *	12/2021	Stelmarski	D3/304

* cited by examiner

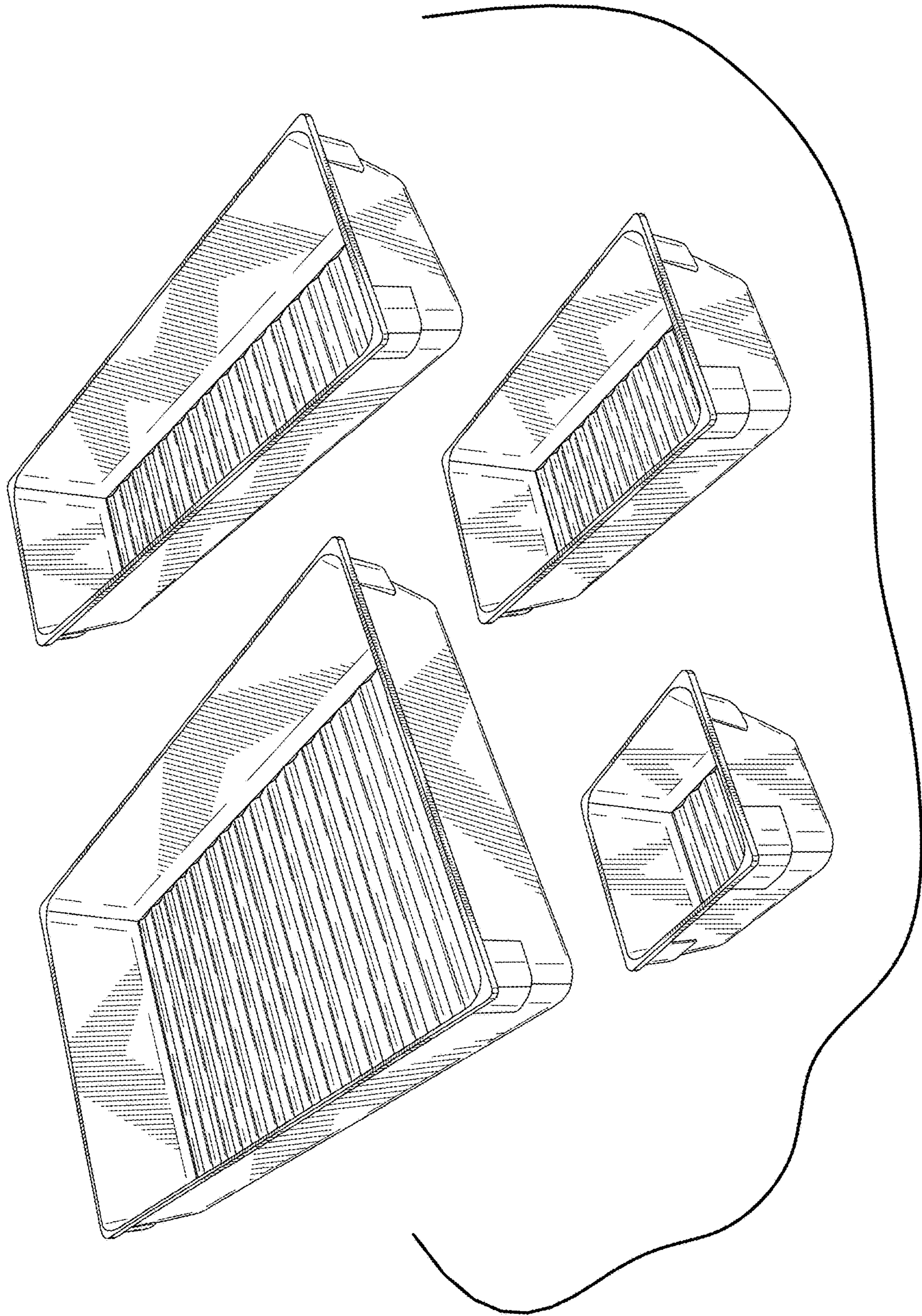

FIG. 1

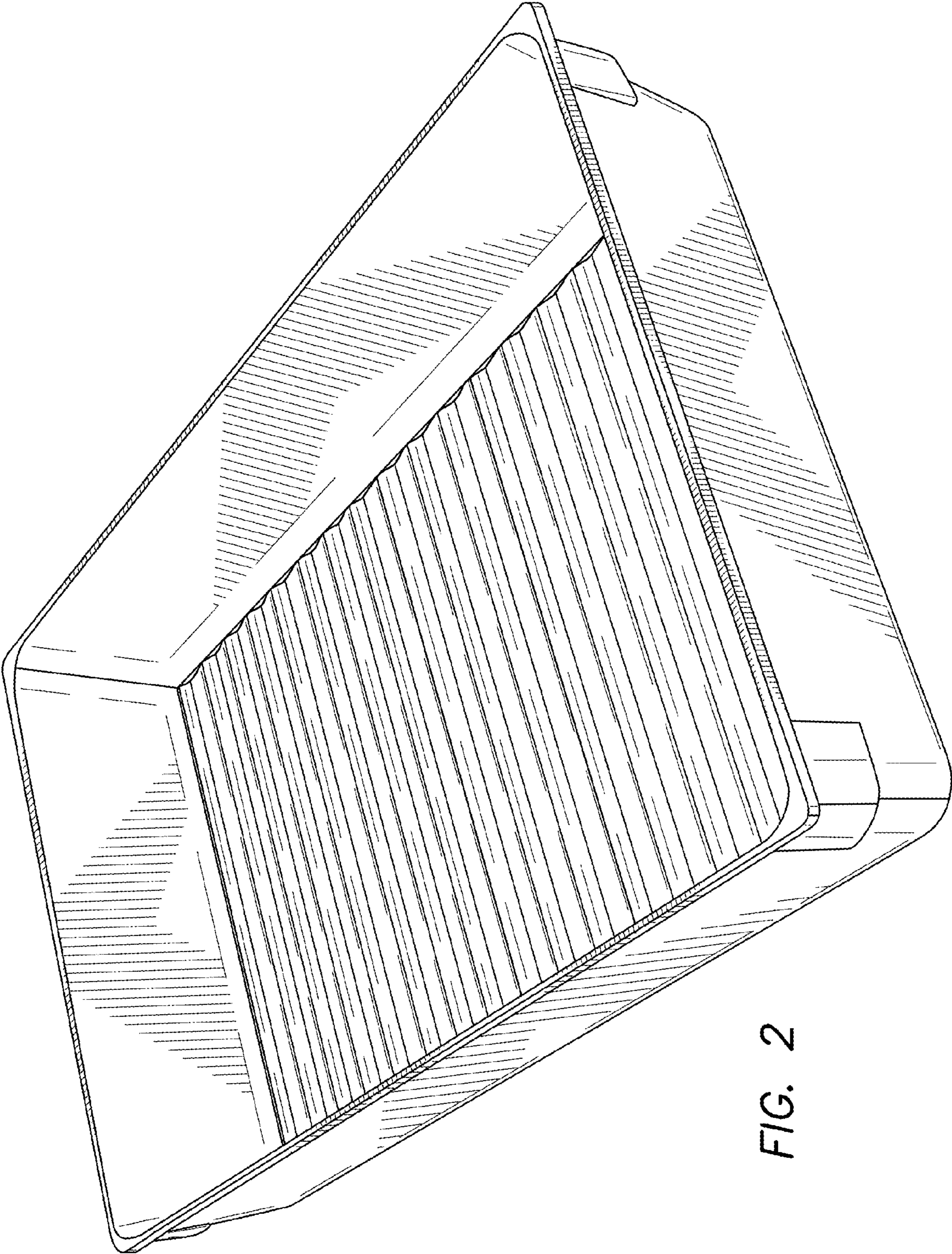

FIG. 2

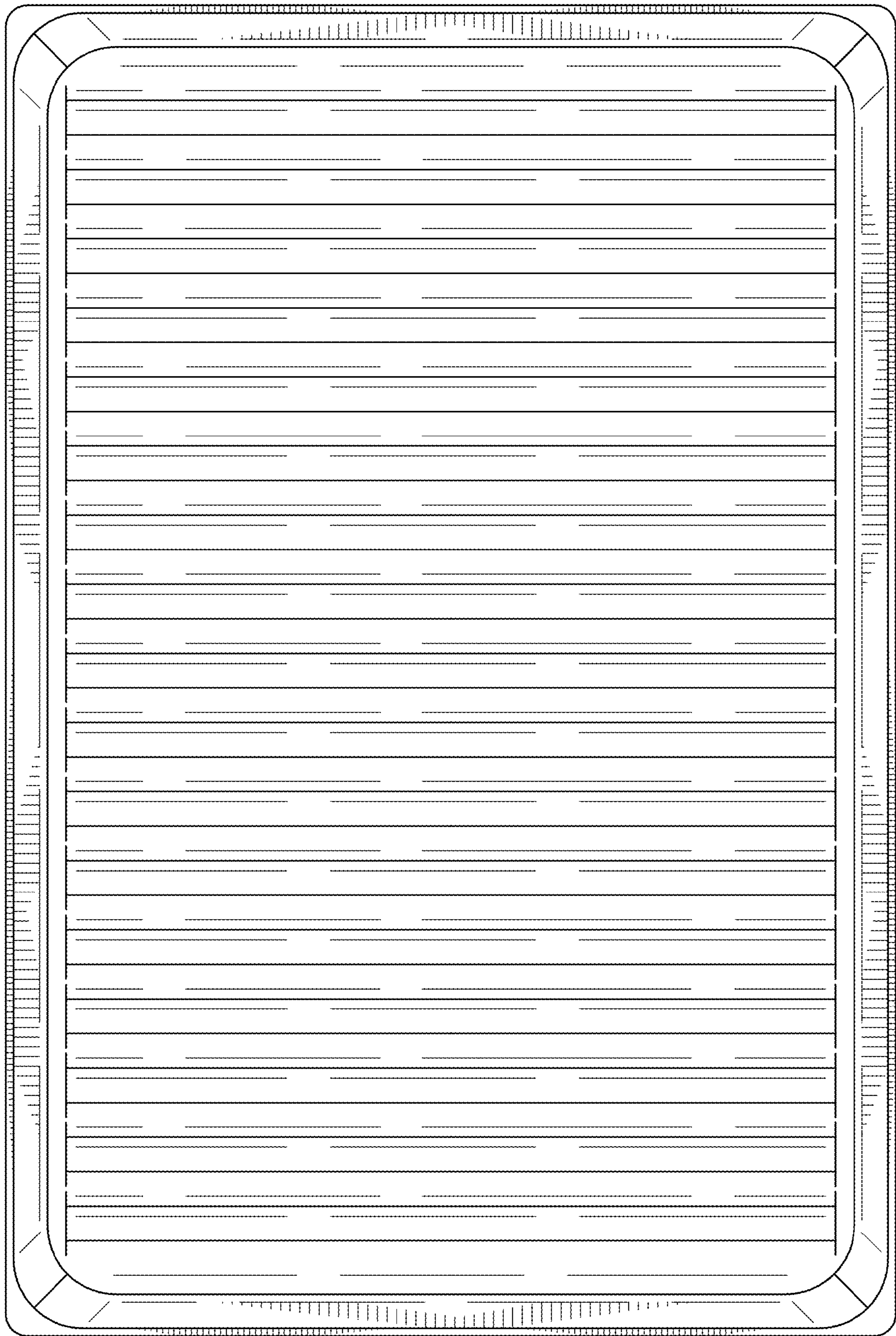

FIG. 3

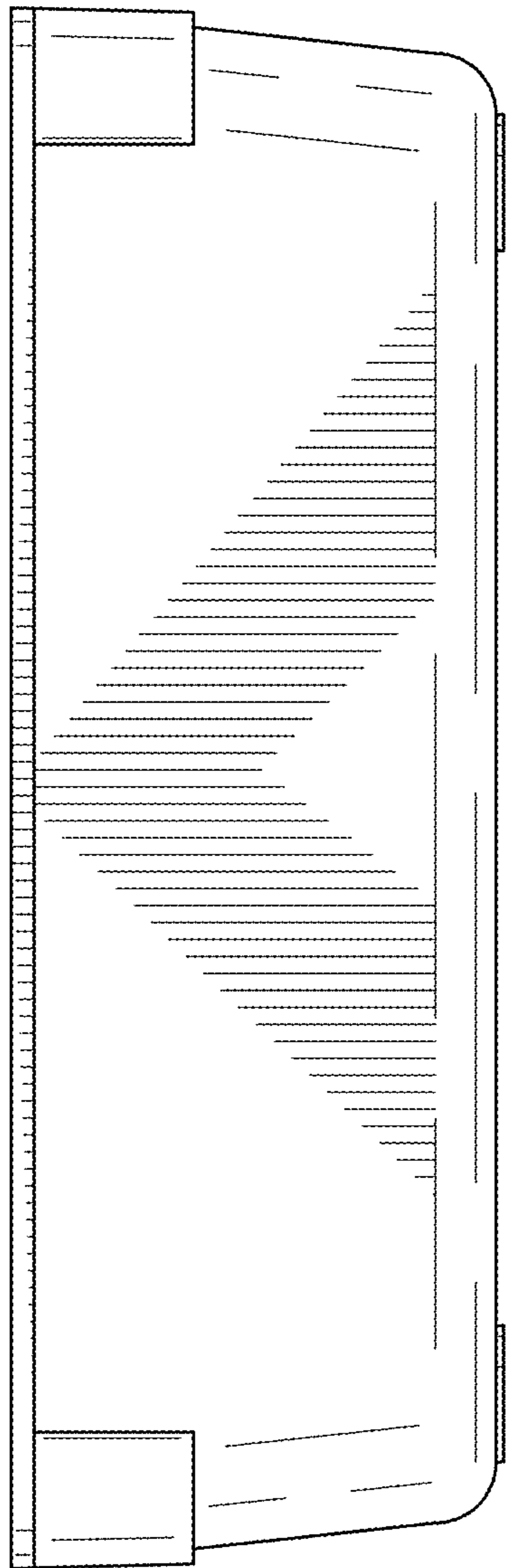

FIG. 4

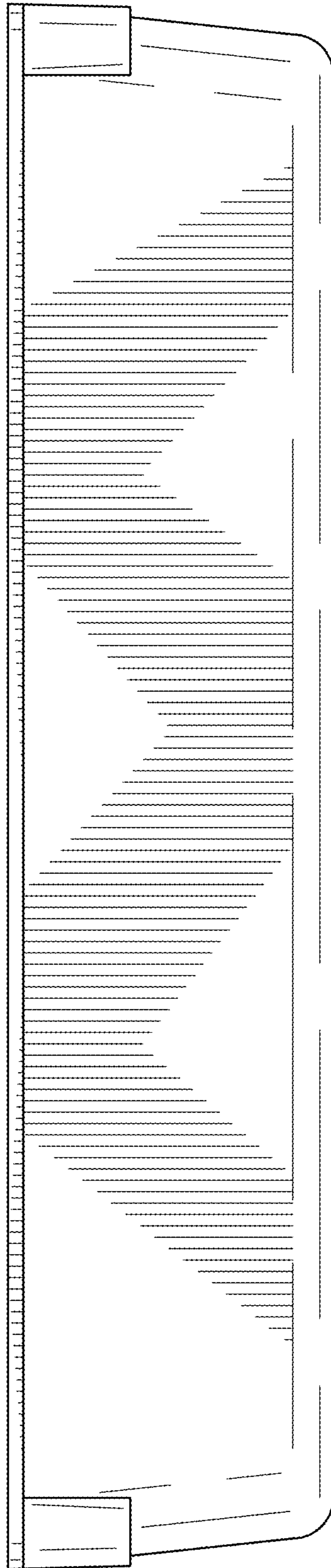

FIG. 5

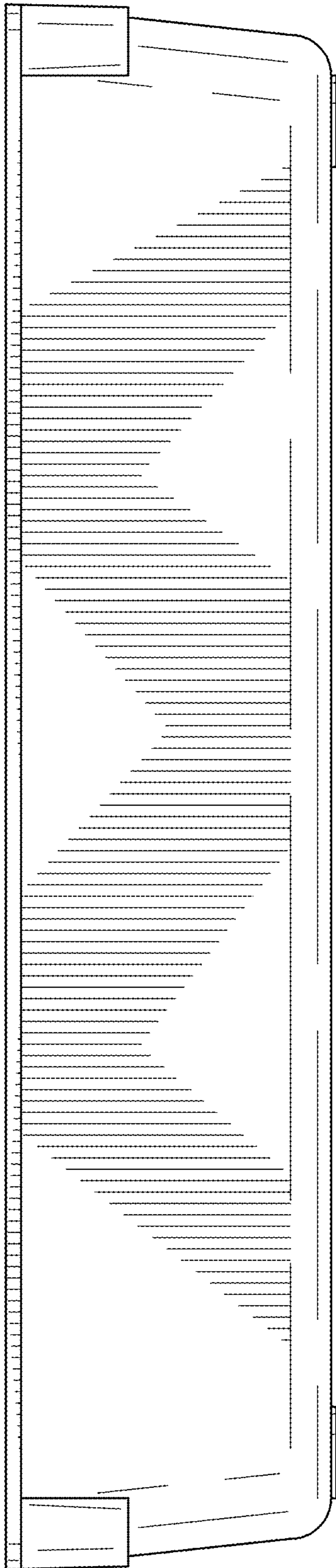

FIG. 6

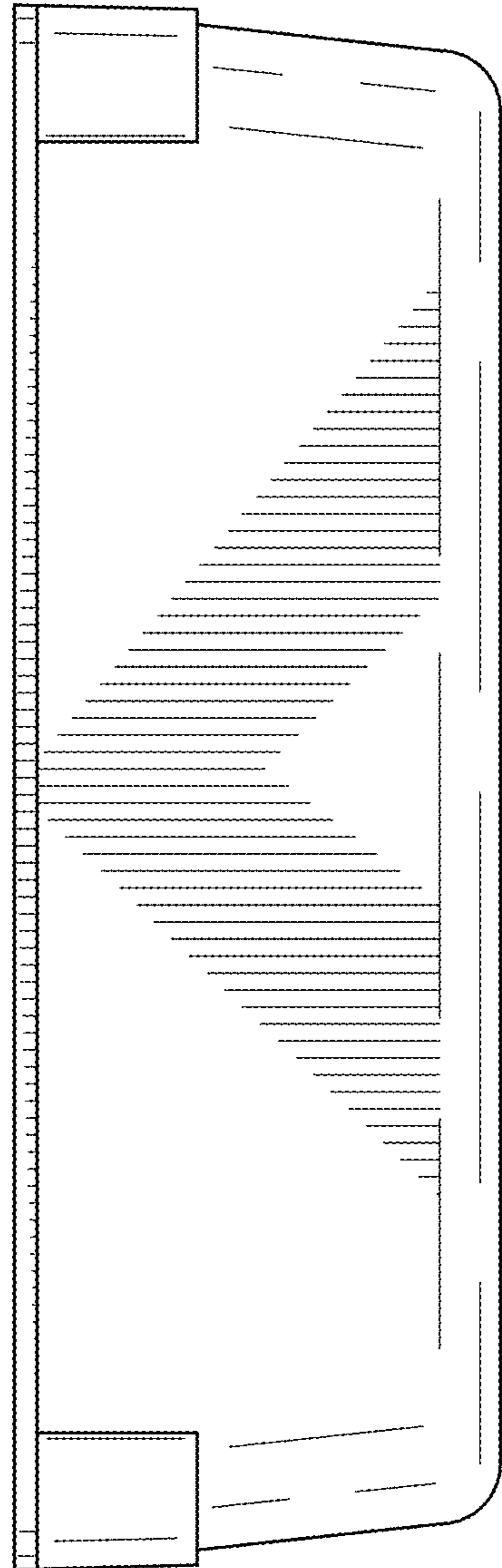

FIG. 7

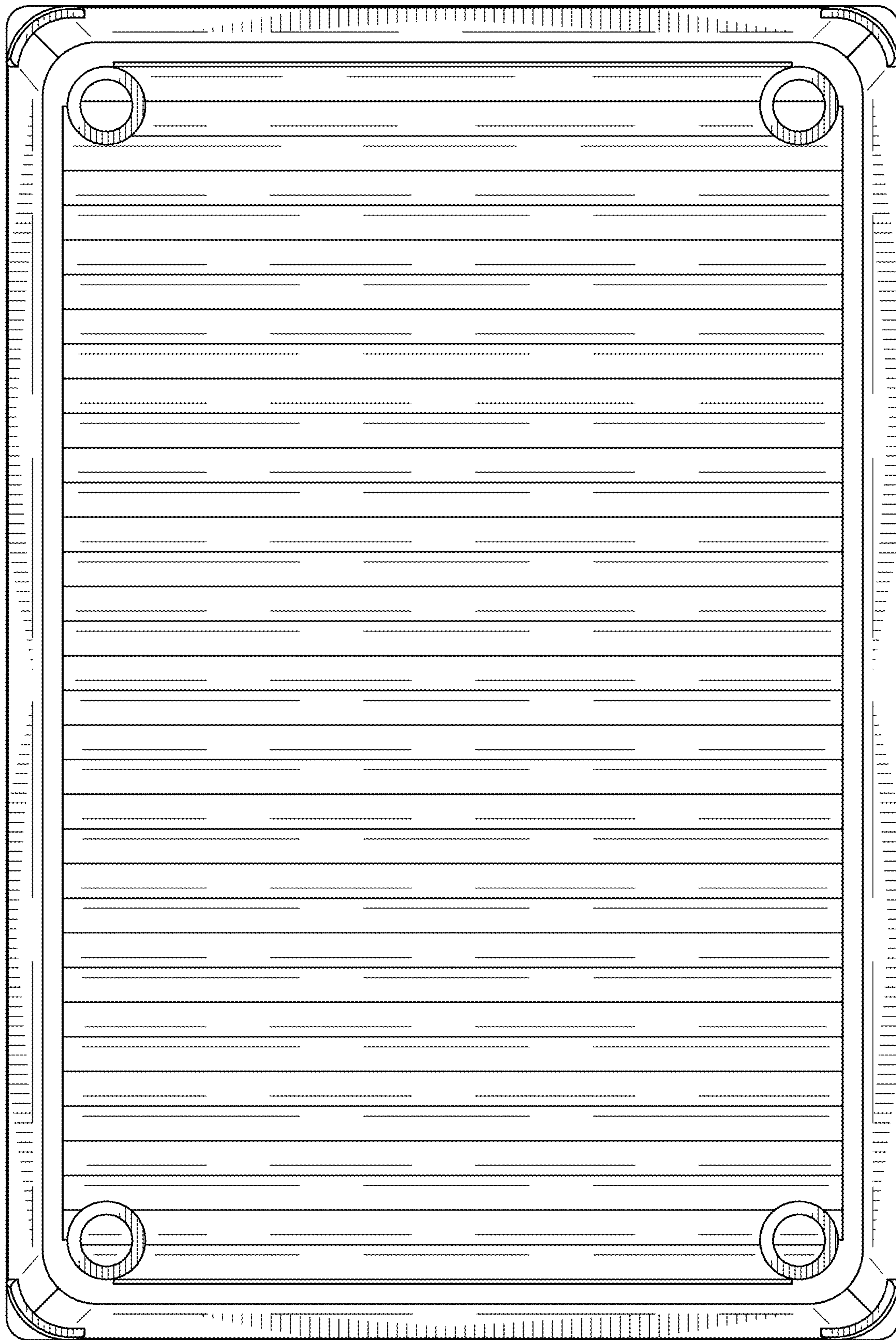

FIG. 8

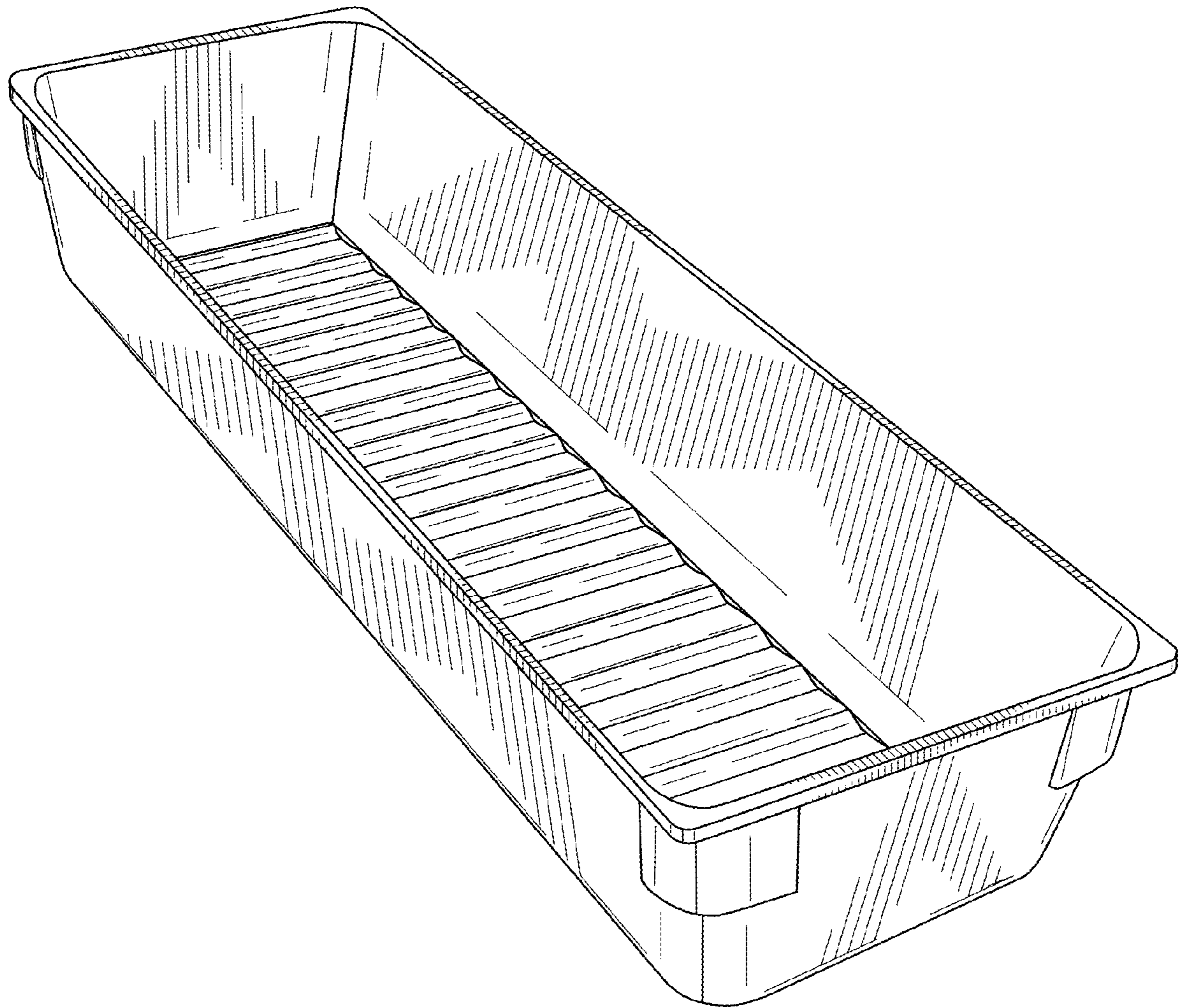

FIG. 9

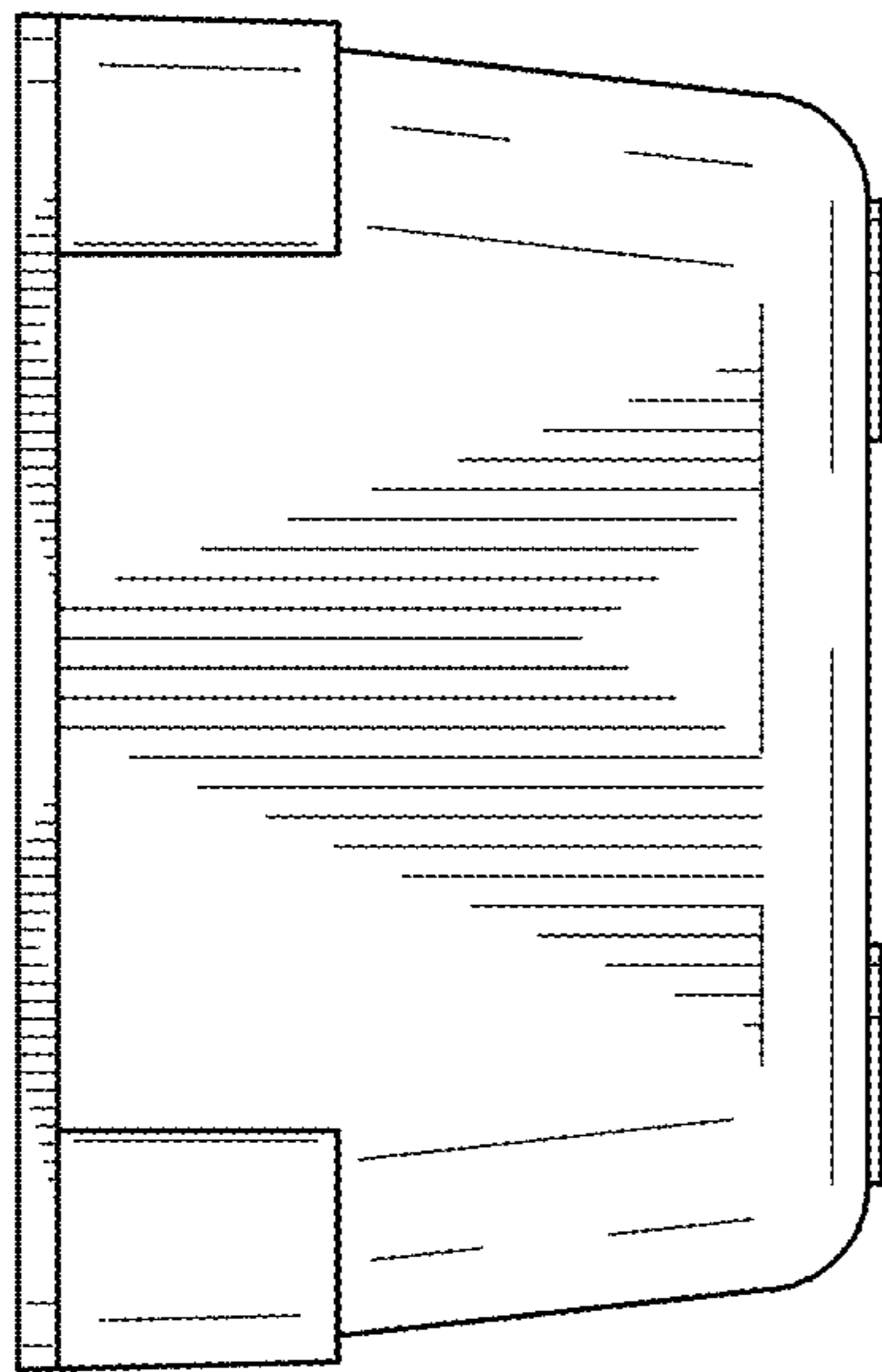

FIG. 10

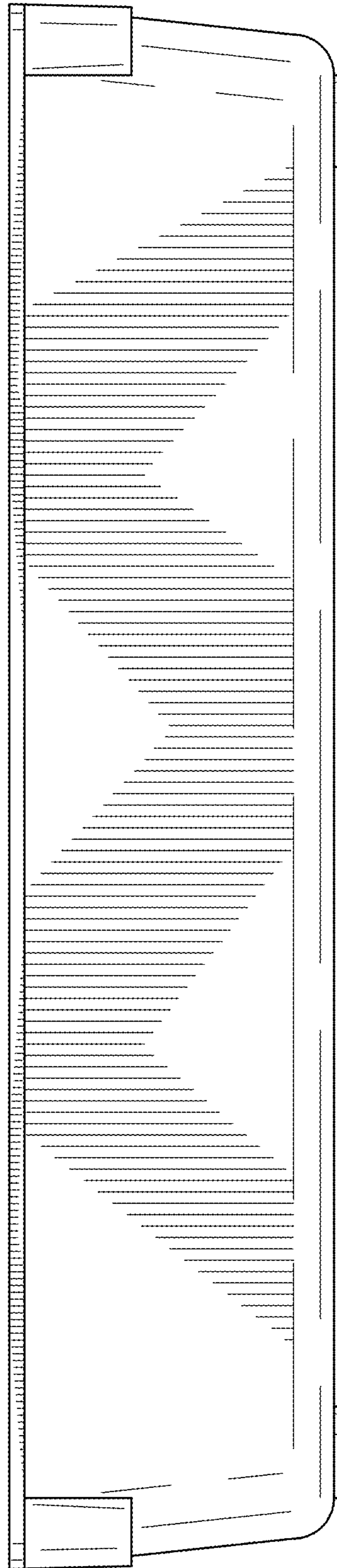

FIG. 11

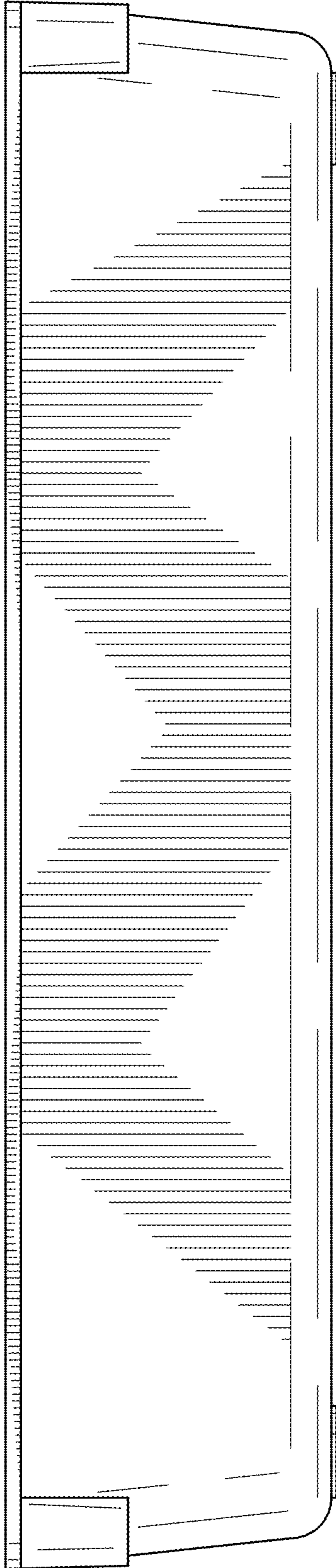

FIG. 12

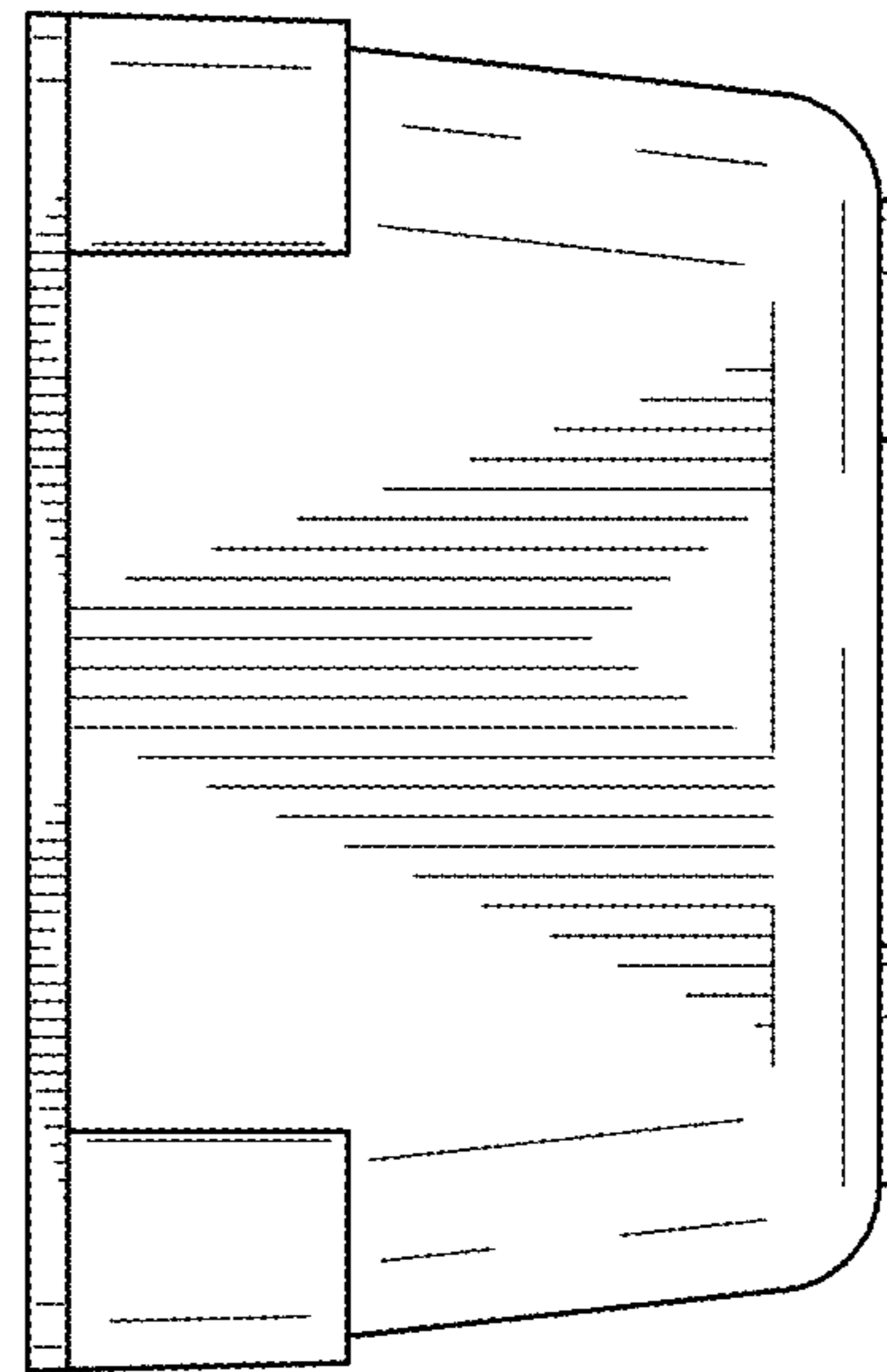

FIG. 13

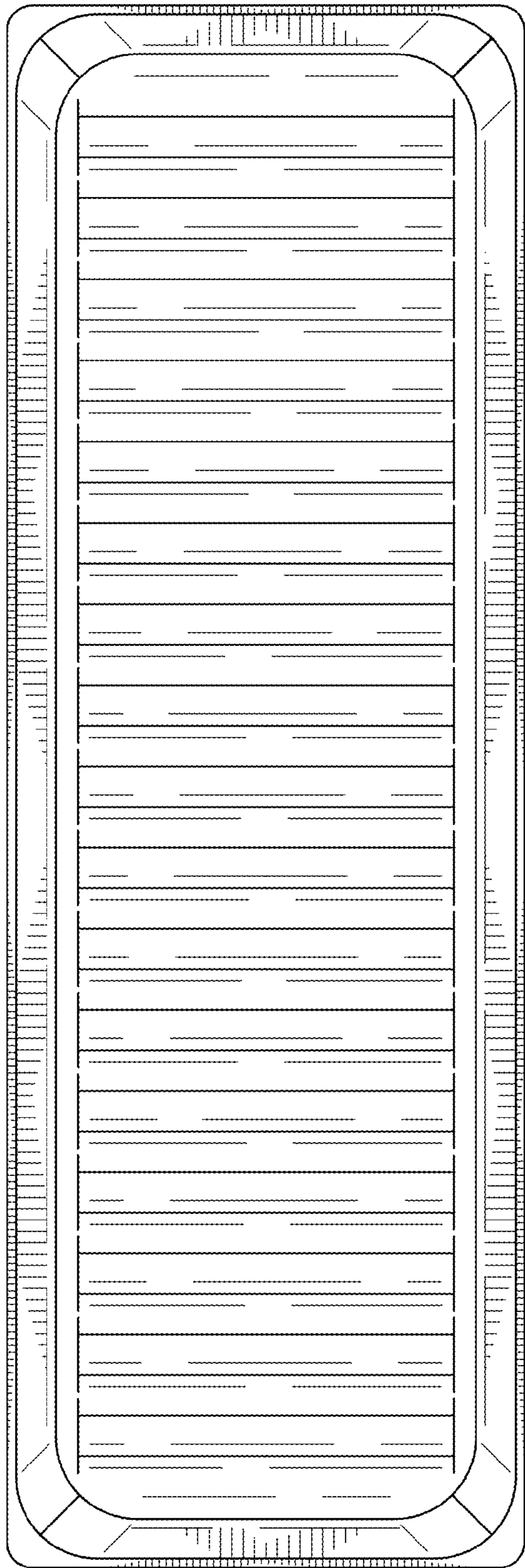

FIG. 14

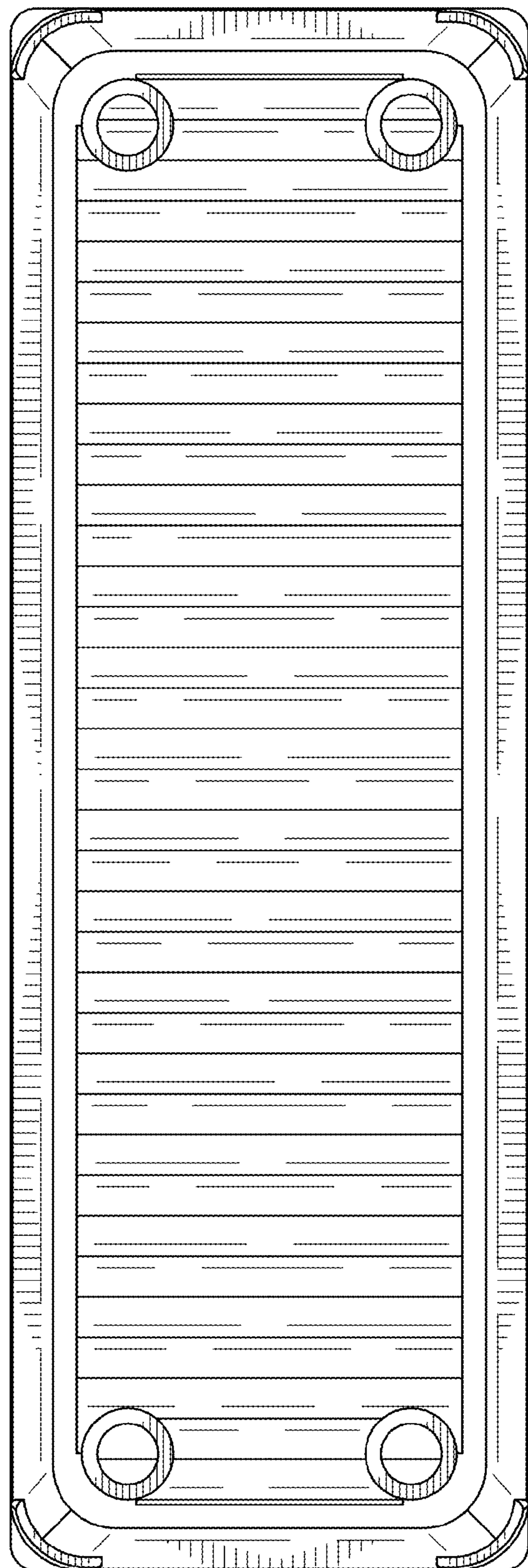

FIG. 15

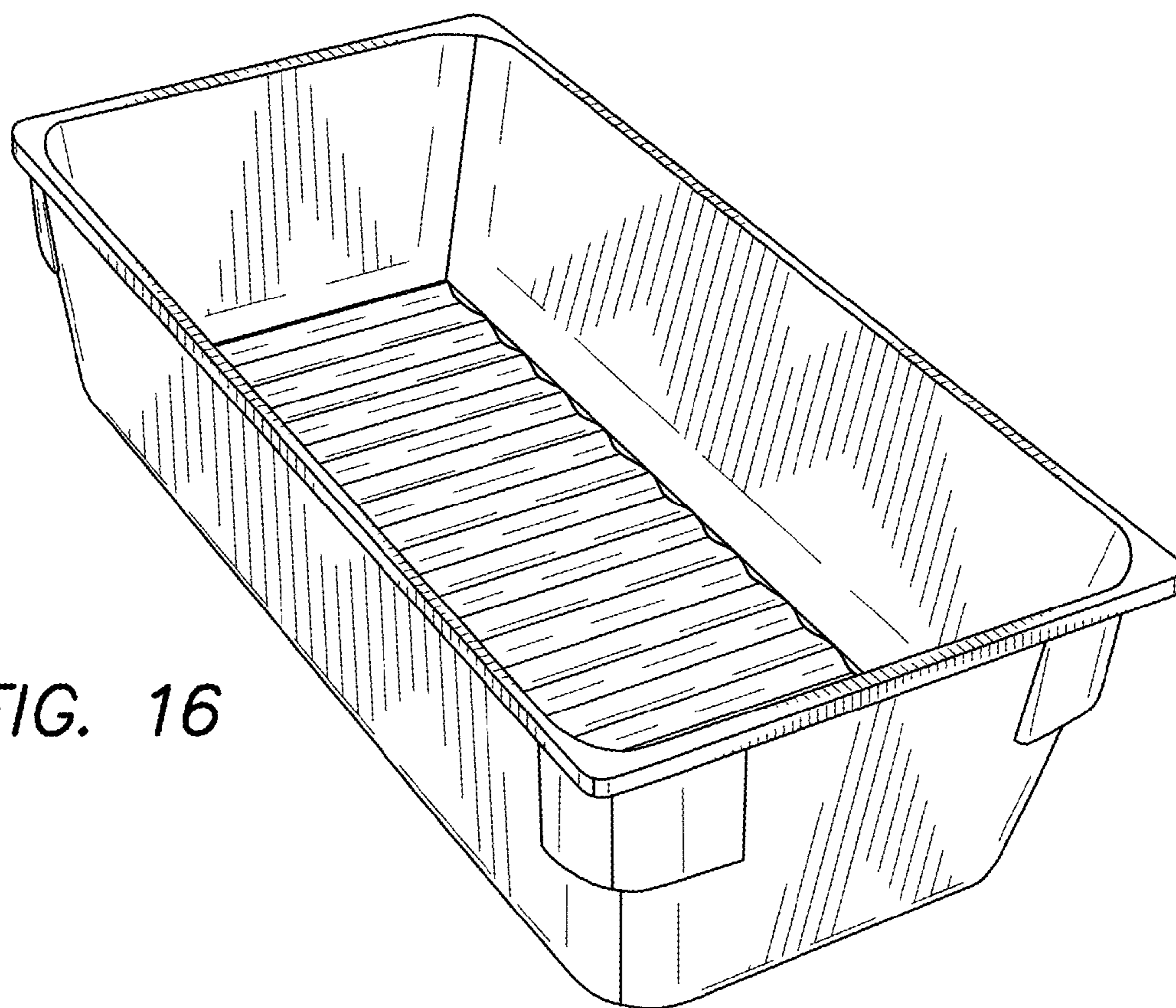

FIG. 16

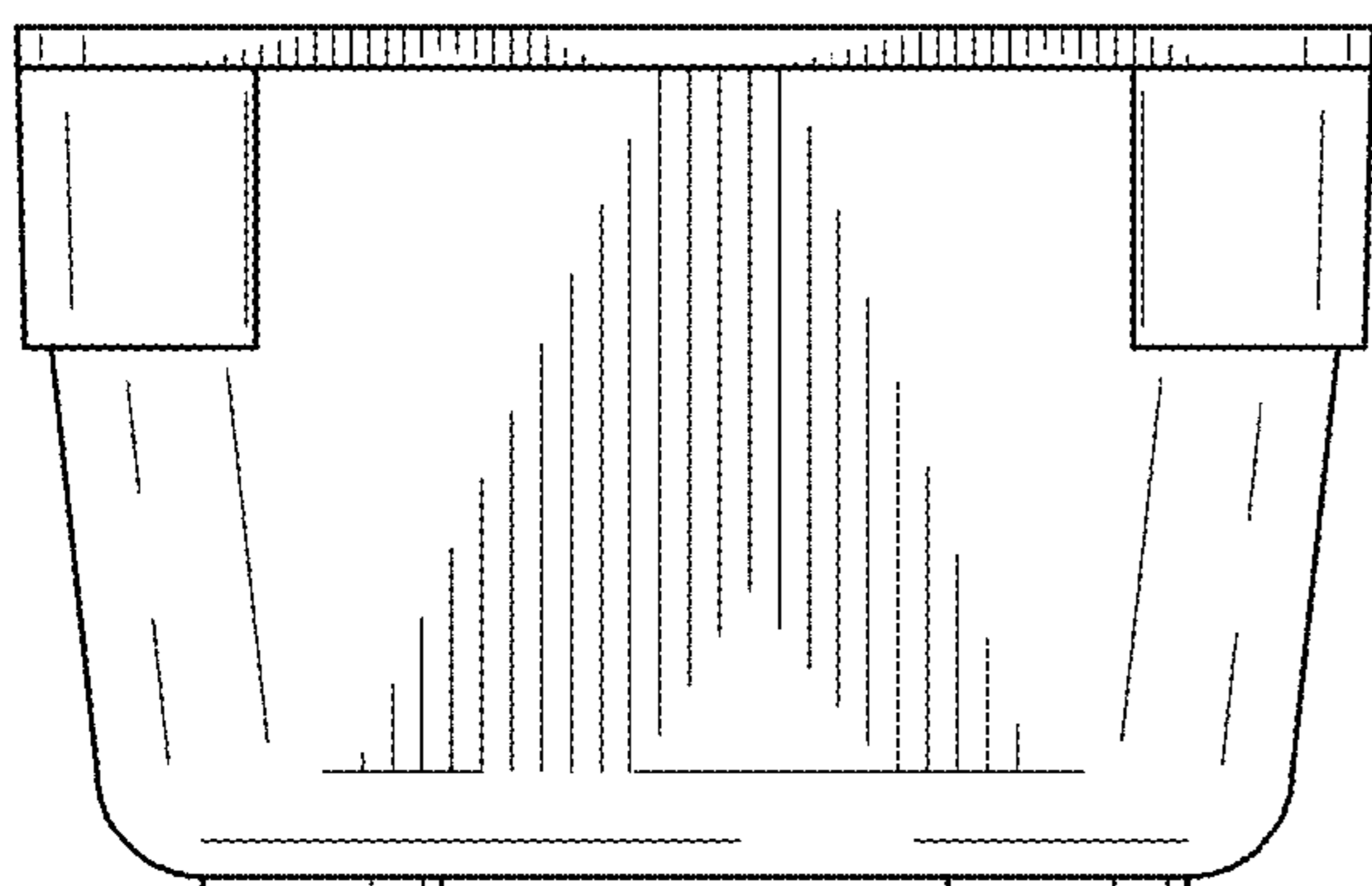

FIG. 17

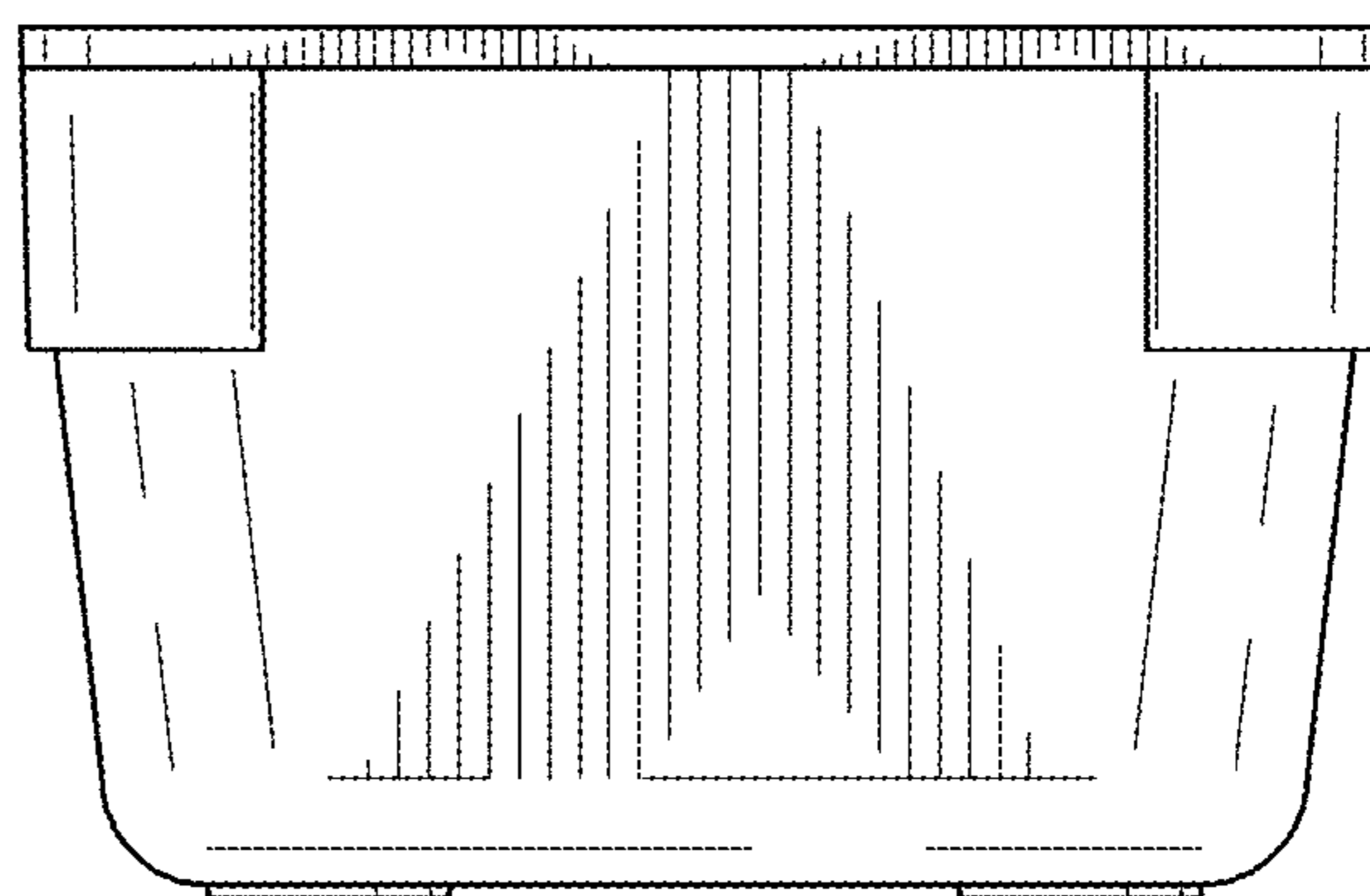

FIG. 20

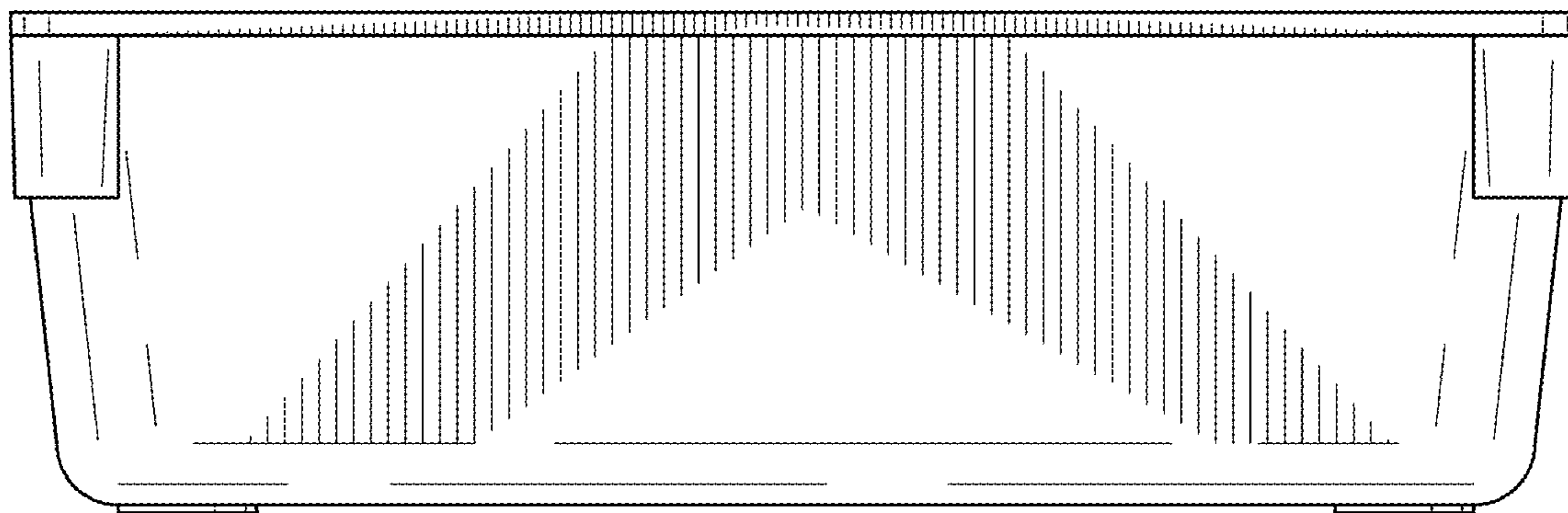

FIG. 18

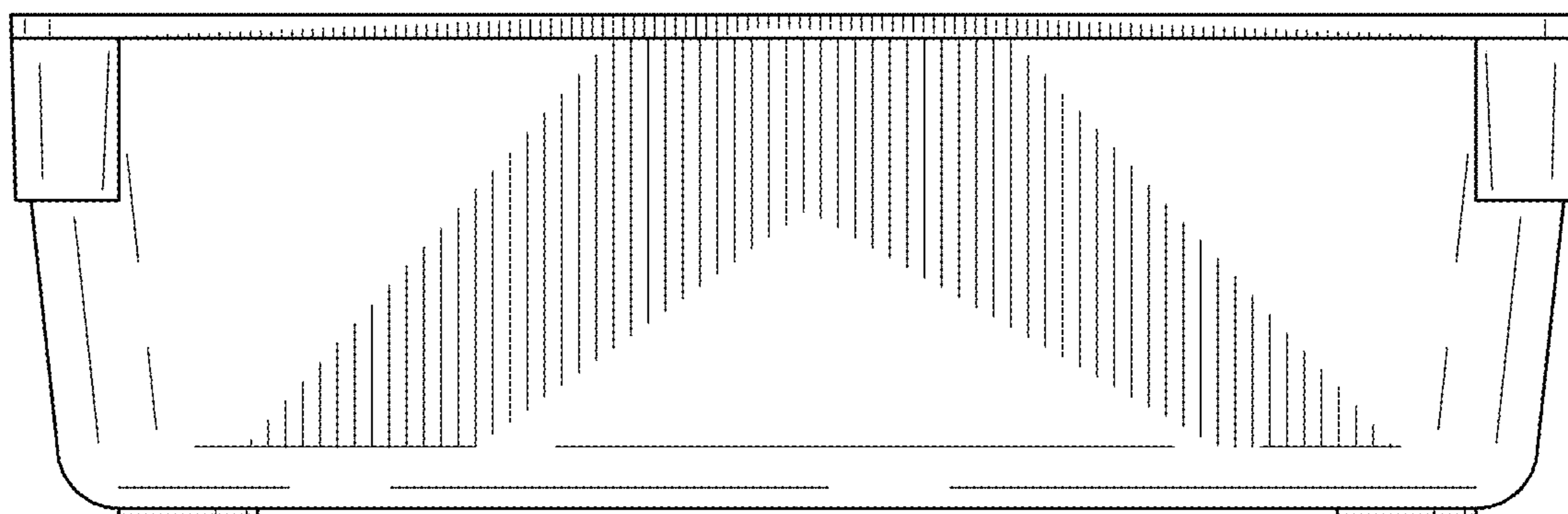

FIG. 19

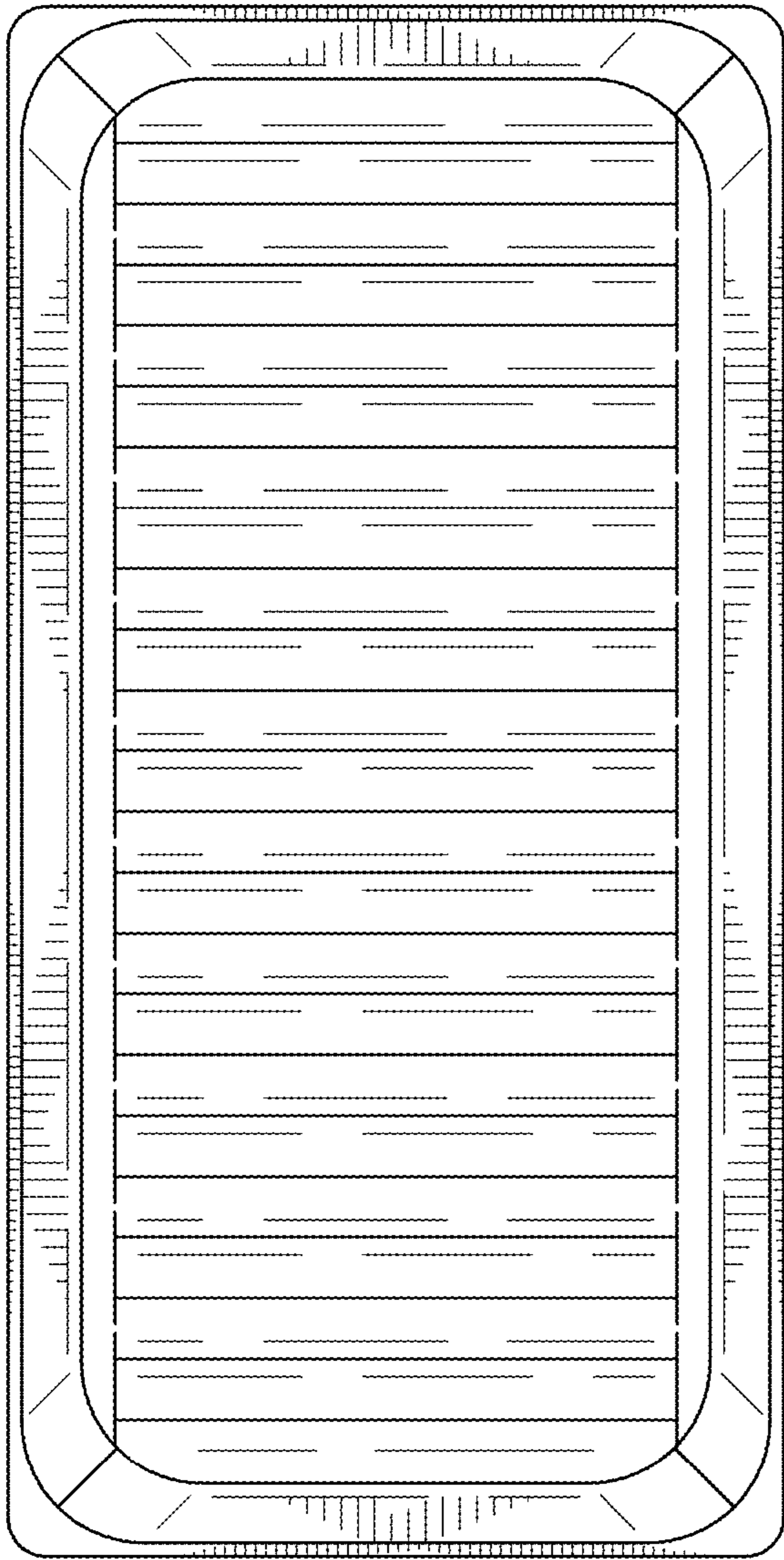
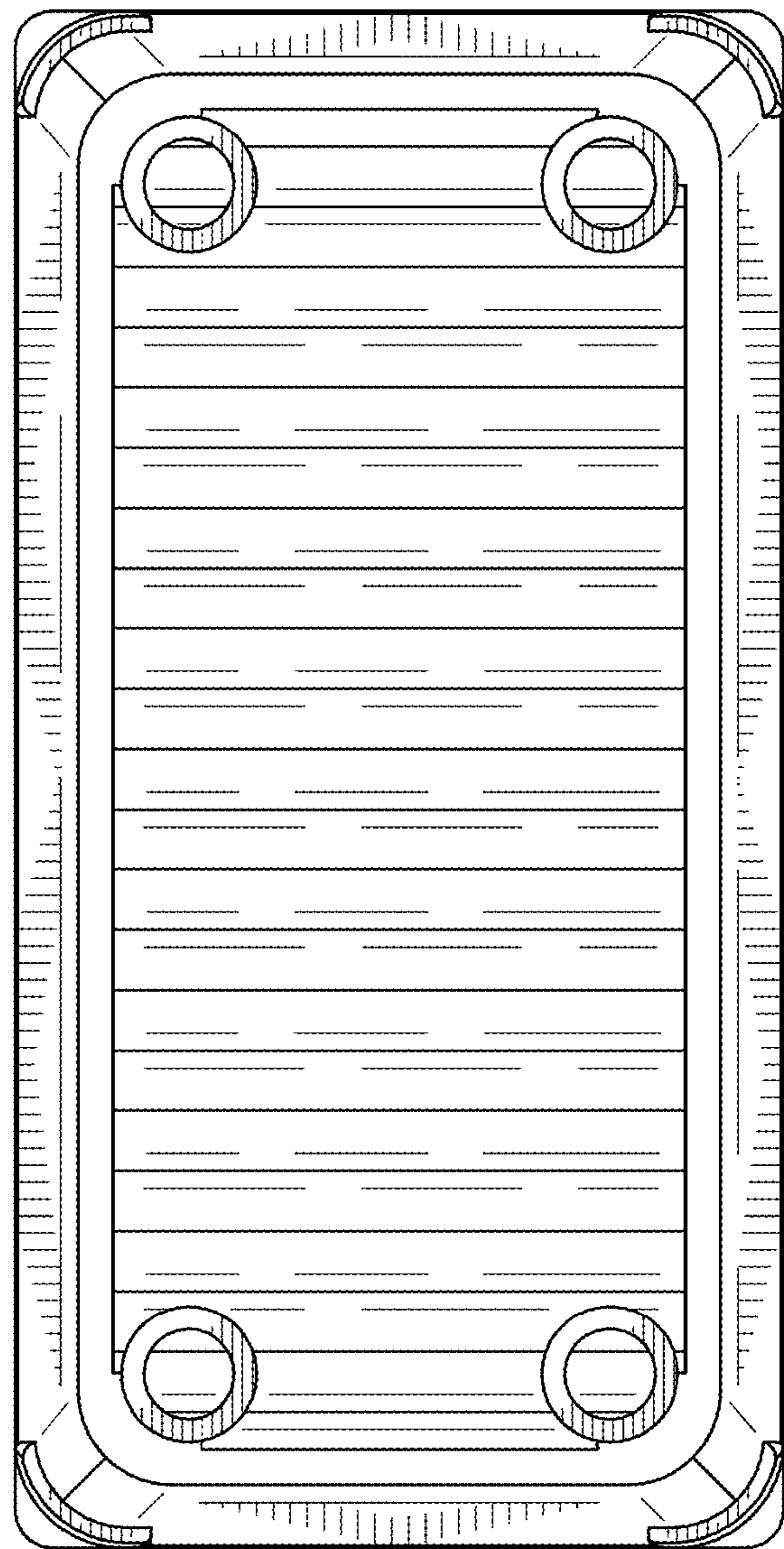

FIG. 21

FIG. 22



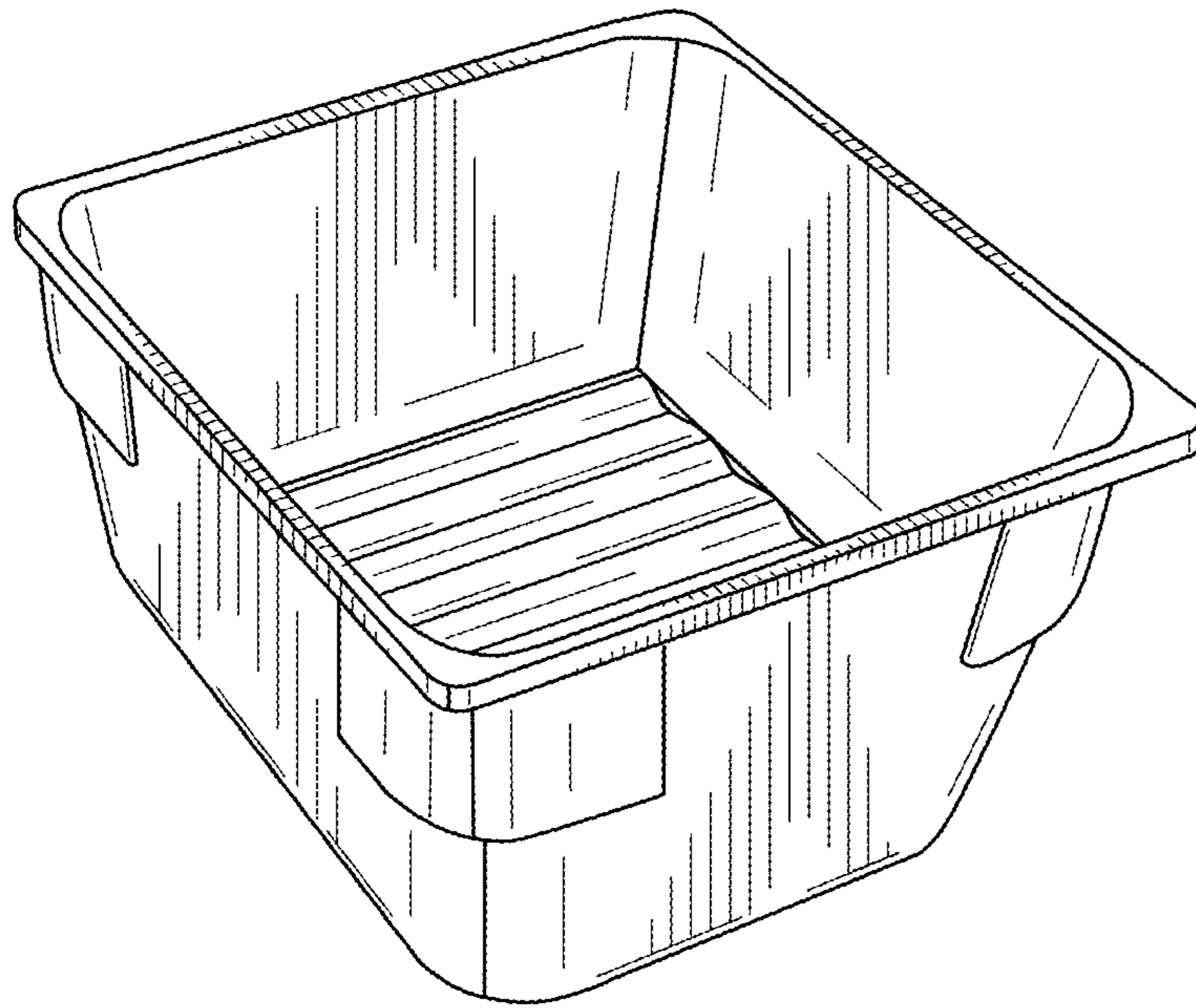

FIG. 23

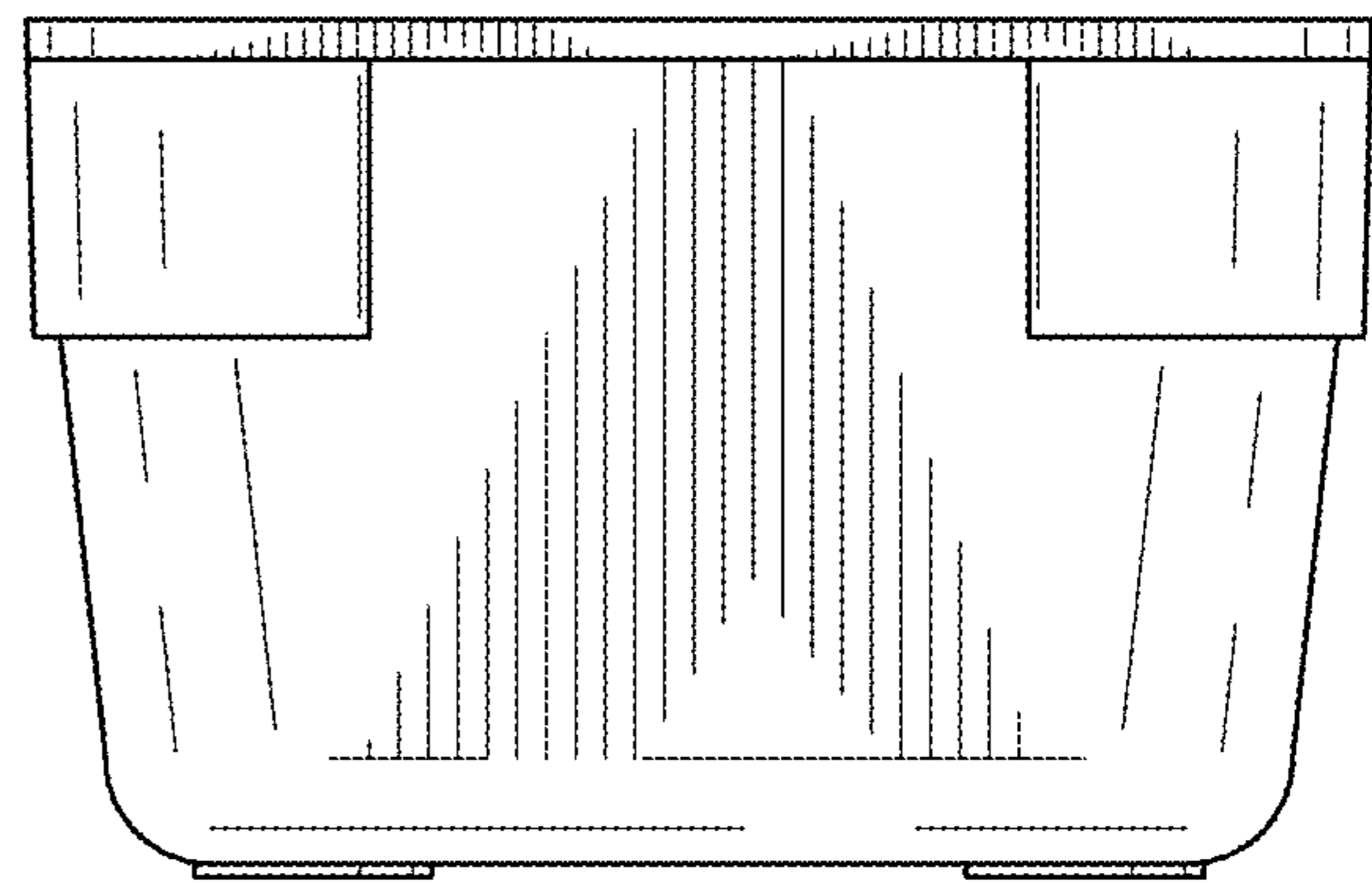

FIG. 24

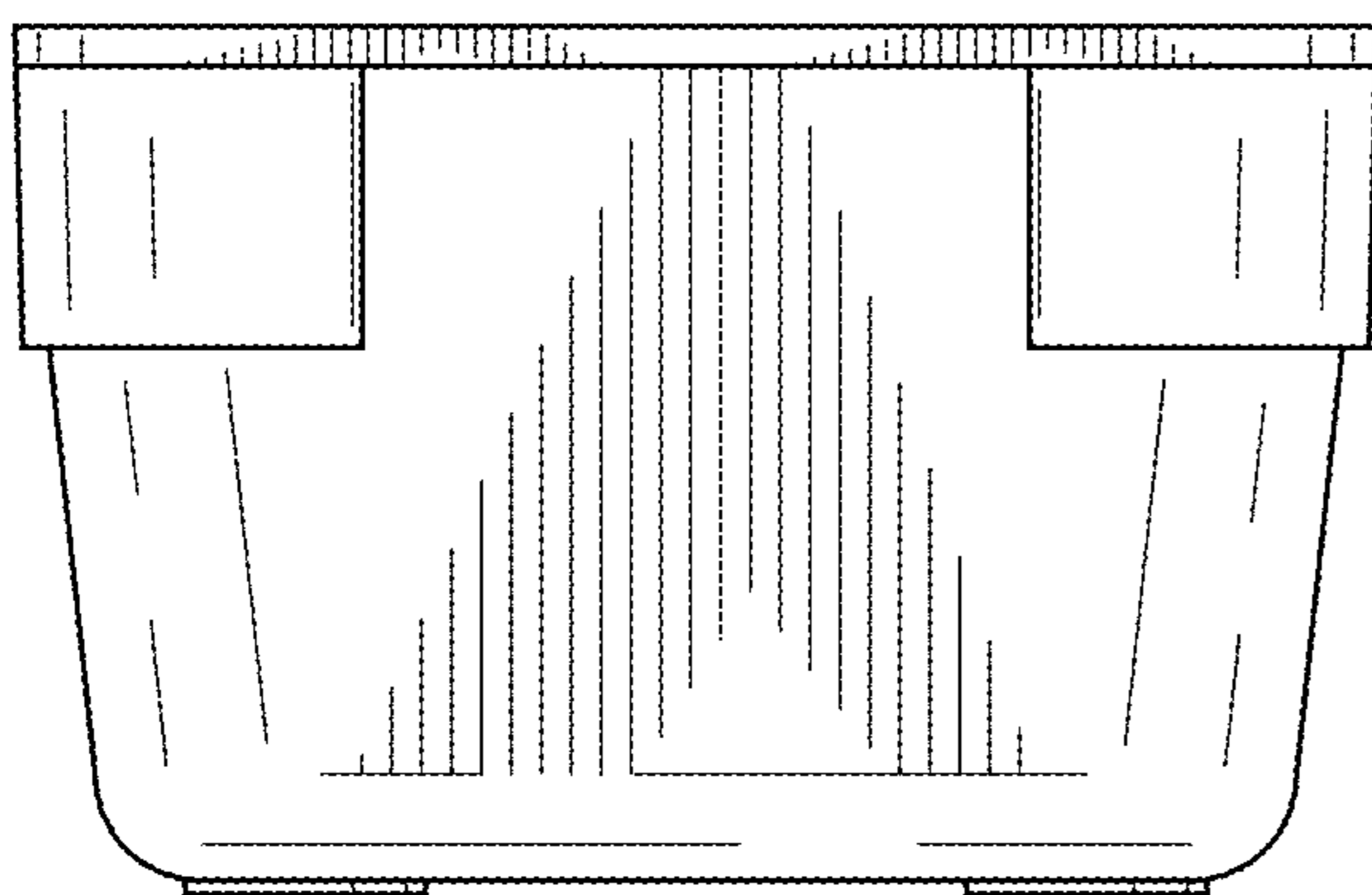

FIG. 25

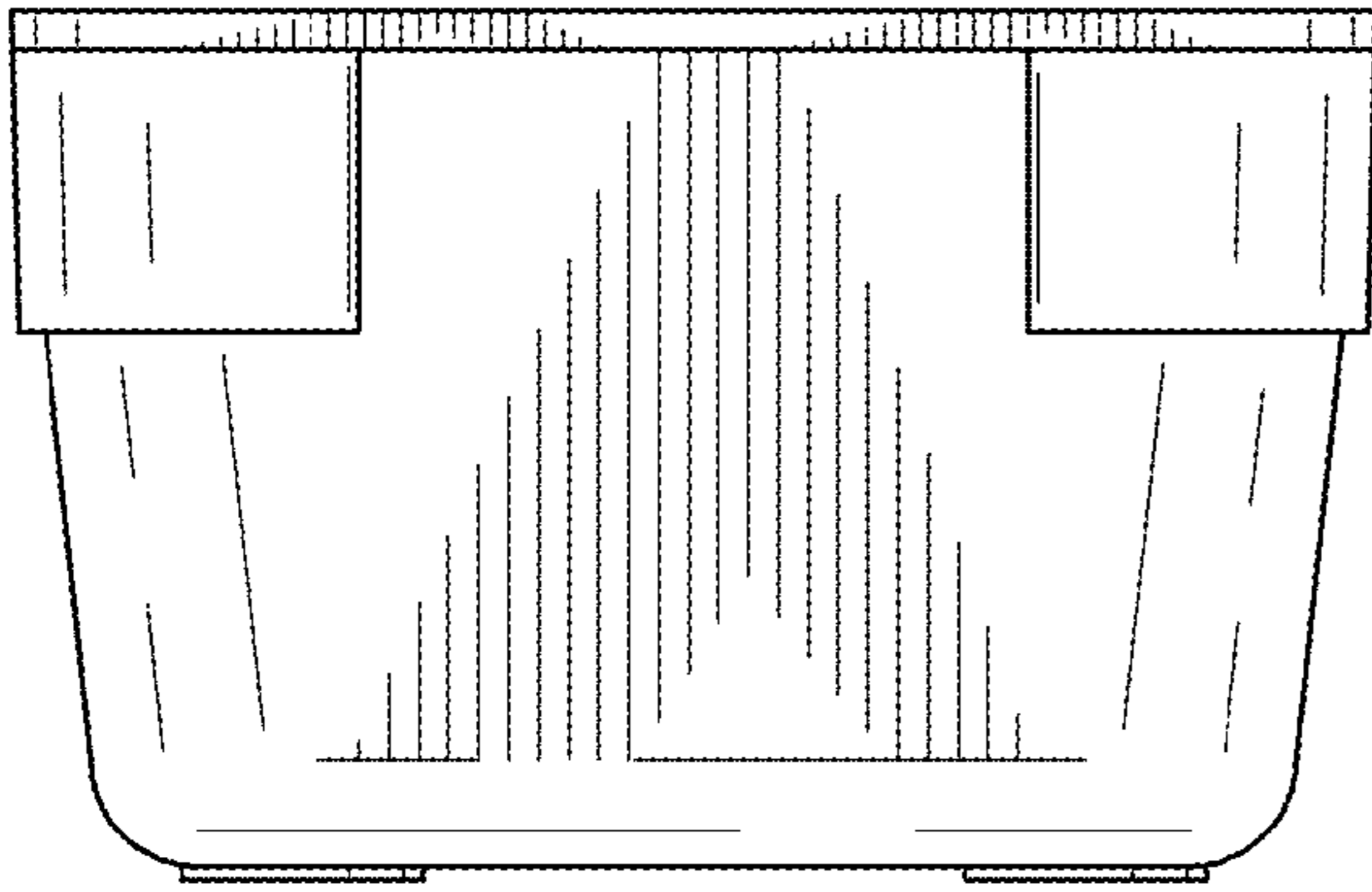

FIG. 26

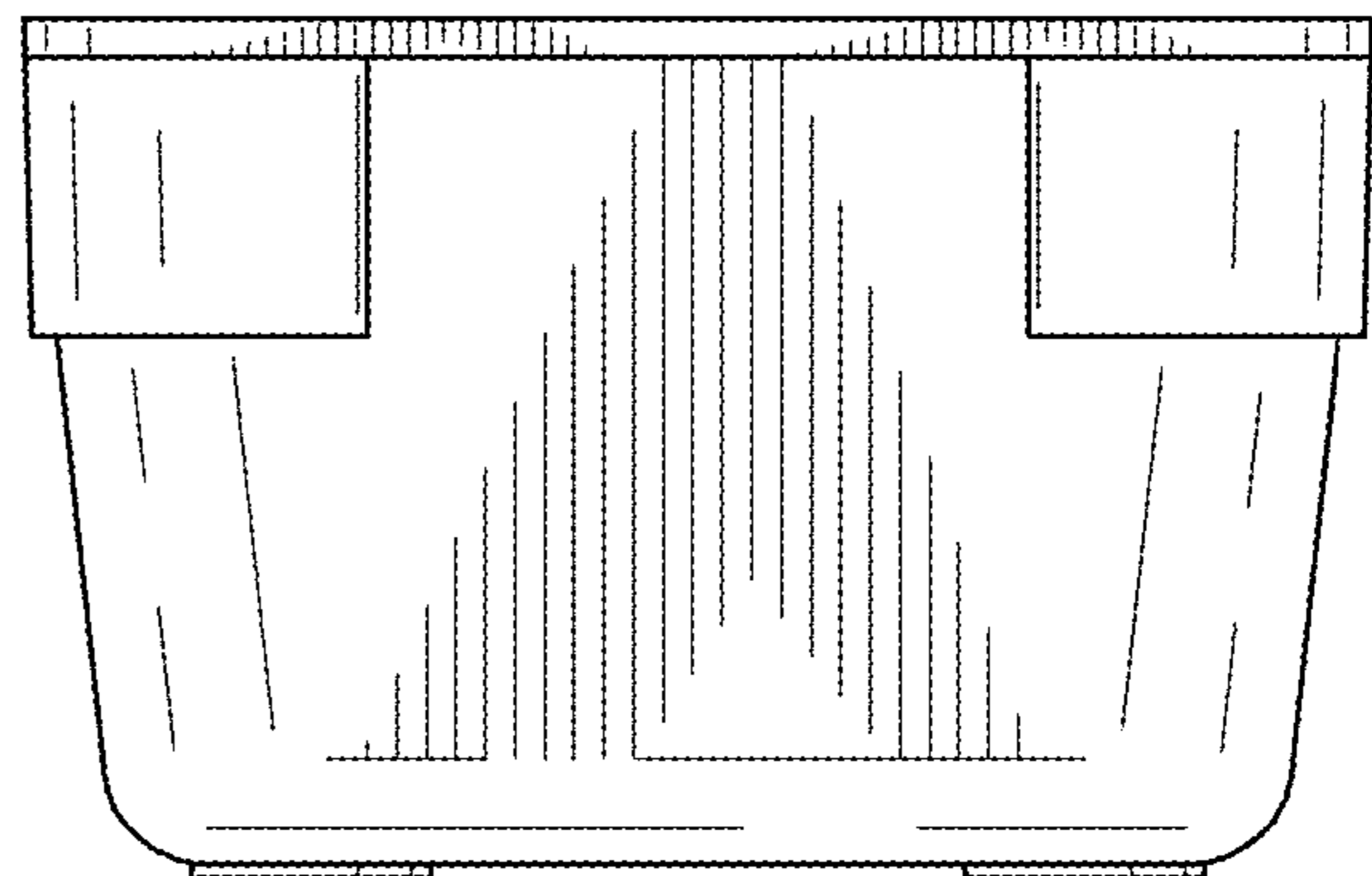

FIG. 27

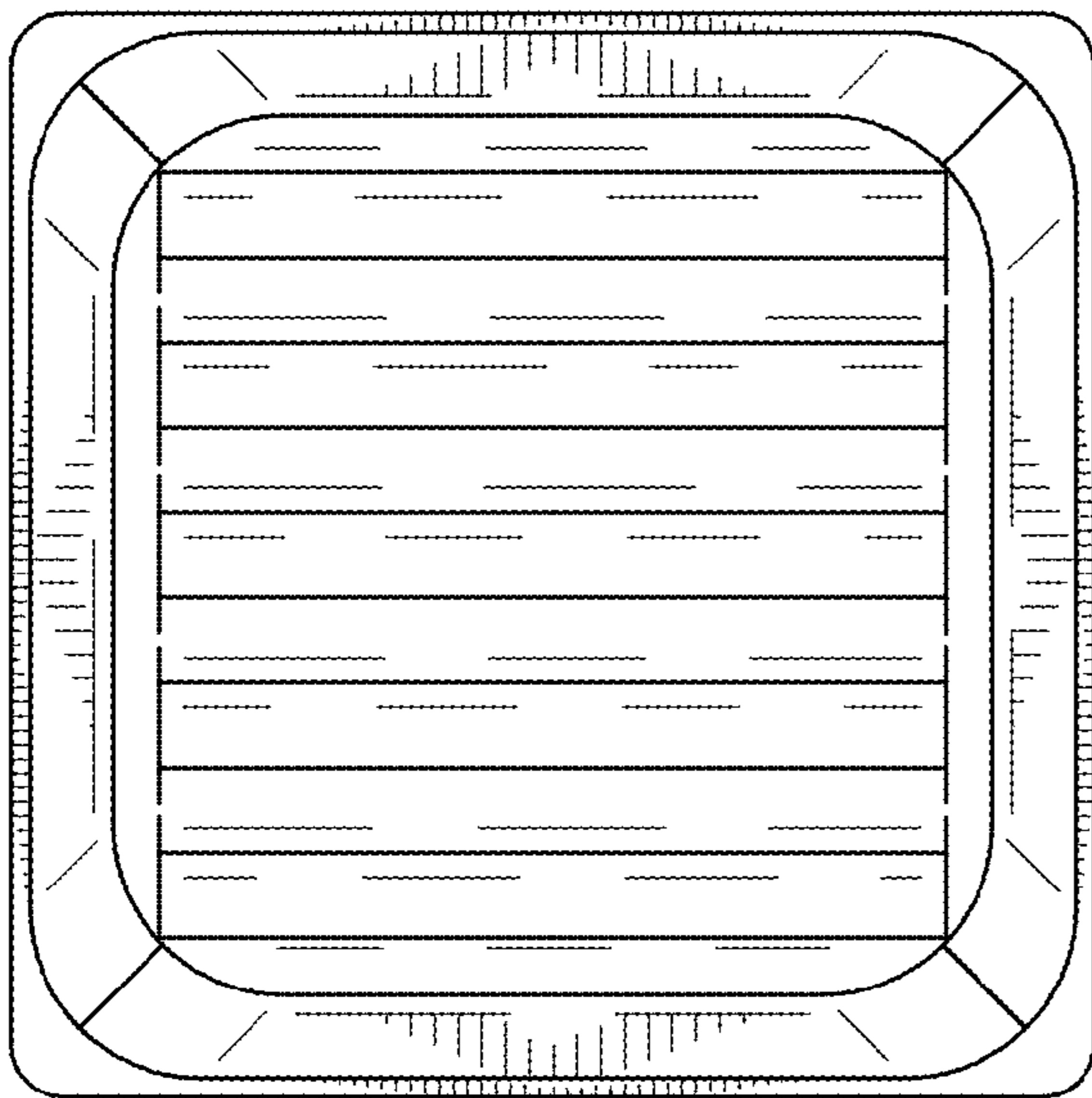

FIG. 28

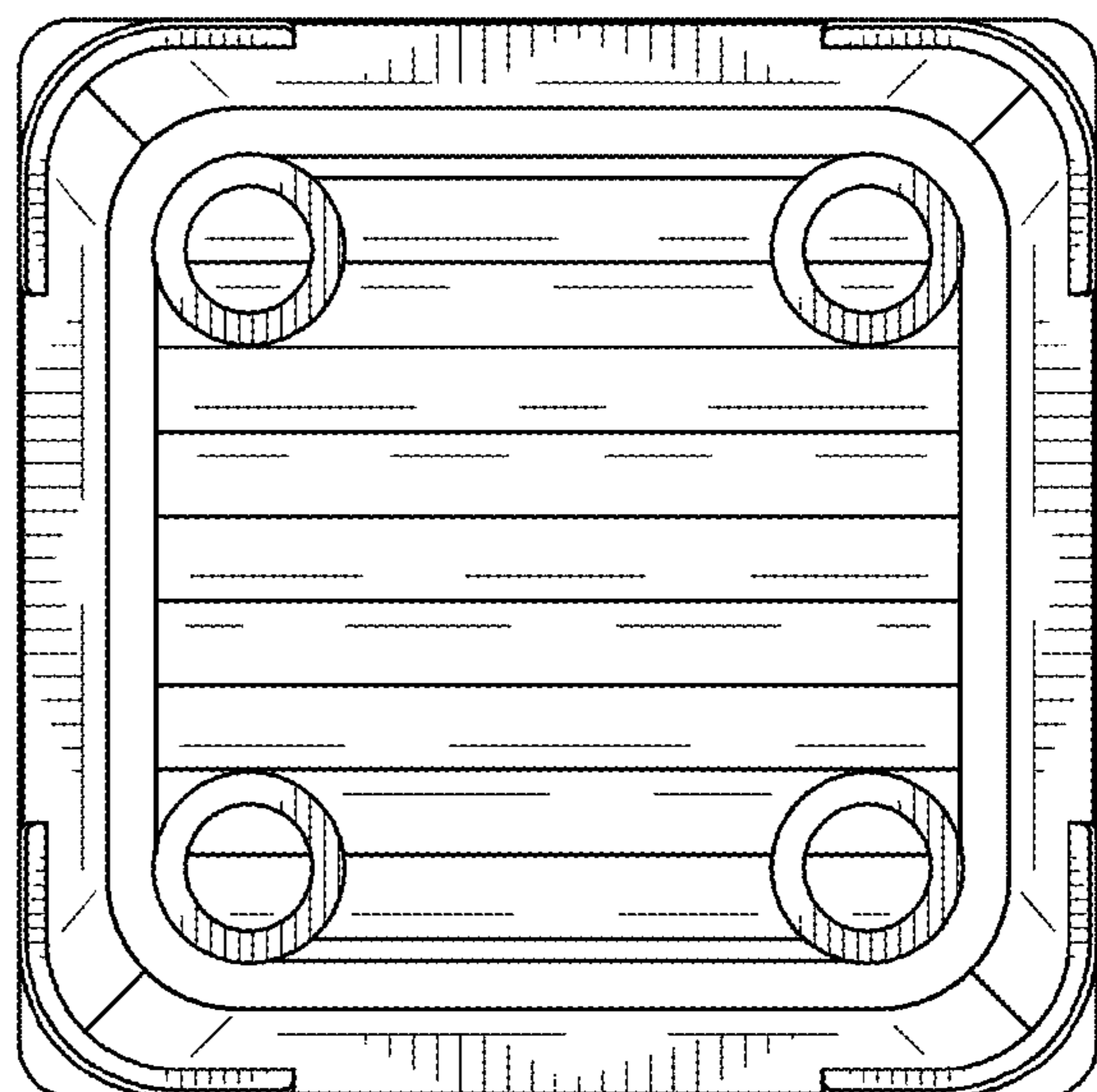

FIG. 29