



US00D945771S

(12) **United States Design Patent**
Dai

(10) **Patent No.:** **US D945,771 S**
(45) **Date of Patent:** **** Mar. 15, 2022**

(54) **SET OF CONTAINERS**

(71) Applicant: **ShenZhen YiHong Technology Co., LTD**, Guangdong (CN)

(72) Inventor: **Yi Dai**, ShenZhen (CN)

(73) Assignee: **ShenZhen YiHong Technology CO., LTD**, ShenZhen (CN)

(**) Term: **15 Years**

(21) Appl. No.: **29/782,331**

(22) Filed: **May 6, 2021**

(51) **LOC (13) Cl.** **03-01**

(52) **U.S. Cl.**
USPC **D3/304**

(58) **Field of Classification Search**
USPC D3/304, 307-314, 315; D6/512;
D7/500, 550.1, 554.3, 601
CPC A45C 2011/007; B65D 1/00; B65D 1/34;
B65D 69/00; B65D 2585/00; A45D
2033/001
See application file for complete search history.

(56) **References Cited**

U.S. PATENT DOCUMENTS

1,553,617	A *	9/1925	Katzinger	126/390.1
2,377,015	A *	5/1945	Kollman	A21B 3/134 220/23.2
3,406,860	A *	10/1968	Kaufman	A21B 3/134 220/23.4
3,572,537	A *	3/1971	Baltzer	A21B 3/134 220/23.4
D323,296	S *	1/1992	Schoenthaler	D3/307
D547,064	S *	7/2007	Snell	D3/304
D551,453	S *	9/2007	Snell	D3/304

(Continued)

Primary Examiner — Kelley A Donnelly

(74) *Attorney, Agent, or Firm* — iPA & iPM

(57) **CLAIM**

The ornamental design for a set of containers, as shown and described.

DESCRIPTION

FIG. 1 is a perspective view of a set of containers showing my new design;
 FIG. 2 is a perspective view of a first container among the set;
 FIG. 3 is a front view thereof;
 FIG. 4 is a left side view thereof;
 FIG. 5 is a right side view thereof;
 FIG. 6 is a back view thereof;
 FIG. 7 is a top view thereof; and
 FIG. 8 is a bottom view thereof;
 FIG. 9 is a perspective view of a second container among the set;
 FIG. 10 is a left side view thereof;
 FIG. 11 is a right side view thereof;
 FIG. 12 is a front view thereof;
 FIG. 13 is a back view thereof;
 FIG. 14 is a top view thereof; and
 FIG. 15 is a bottom view thereof;
 FIG. 16 is a perspective view of a third container among the set;
 FIG. 17 is a left side view thereof;
 FIG. 18 is a right side view thereof;
 FIG. 19 is a front view thereof;
 FIG. 20 is a back view thereof;
 FIG. 21 is a top view thereof; and
 FIG. 22 is a bottom view thereof;
 FIG. 23 is a perspective view of a fourth container among the set;
 FIG. 24 is a left side view thereof;
 FIG. 25 is a right side view thereof;
 FIG. 26 is a front view thereof;
 FIG. 27 is a back view thereof;
 FIG. 28 is a top view thereof; and
 FIG. 29 is a bottom view thereof.

1 Claim, 14 Drawing Sheets

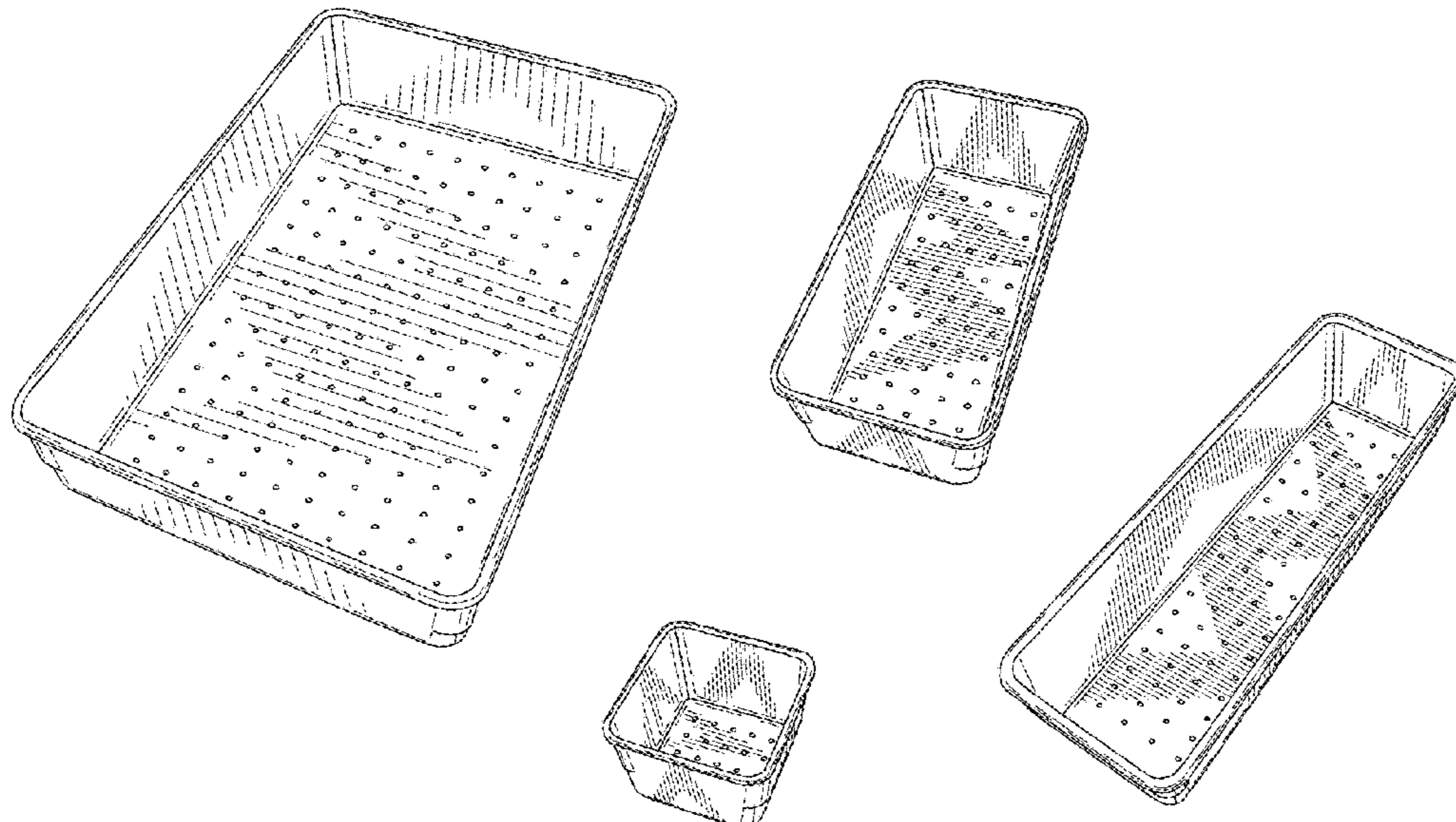

(56)

References Cited

U.S. PATENT DOCUMENTS

D555,904 S	*	11/2007	Snell	D3/304
D612,608 S		3/2010	Snell	
D682,036 S		5/2013	Filbrun	
D712,148 S	*	9/2014	Ghiorgie	D3/304
D713,146 S	*	9/2014	Ghiorgie	D3/304
D727,790 S	*	4/2015	Ramadan	D11/155
D750,892 S		3/2016	Rego	
D812,910 S		3/2018	Harvey	
D819,971 S		6/2018	Lindsay et al.	
D839,656 S	*	2/2019	Patel	D7/359
D848,188 S		5/2019	Holm	
D872,482 S		1/2020	Harvey	
D876,836 S		3/2020	Stevens	
D891,778 S	*	8/2020	Stevens	D3/304
D891,879 S		8/2020	Adams, Jr. et al.	
D908,435 S		1/2021	Luan	
D909,238 S	*	2/2021	Choi	D11/155
D935,775 S	*	11/2021	Tsai	D3/306
D938,726 S	*	12/2021	Stelmarski	D3/304

* cited by examiner

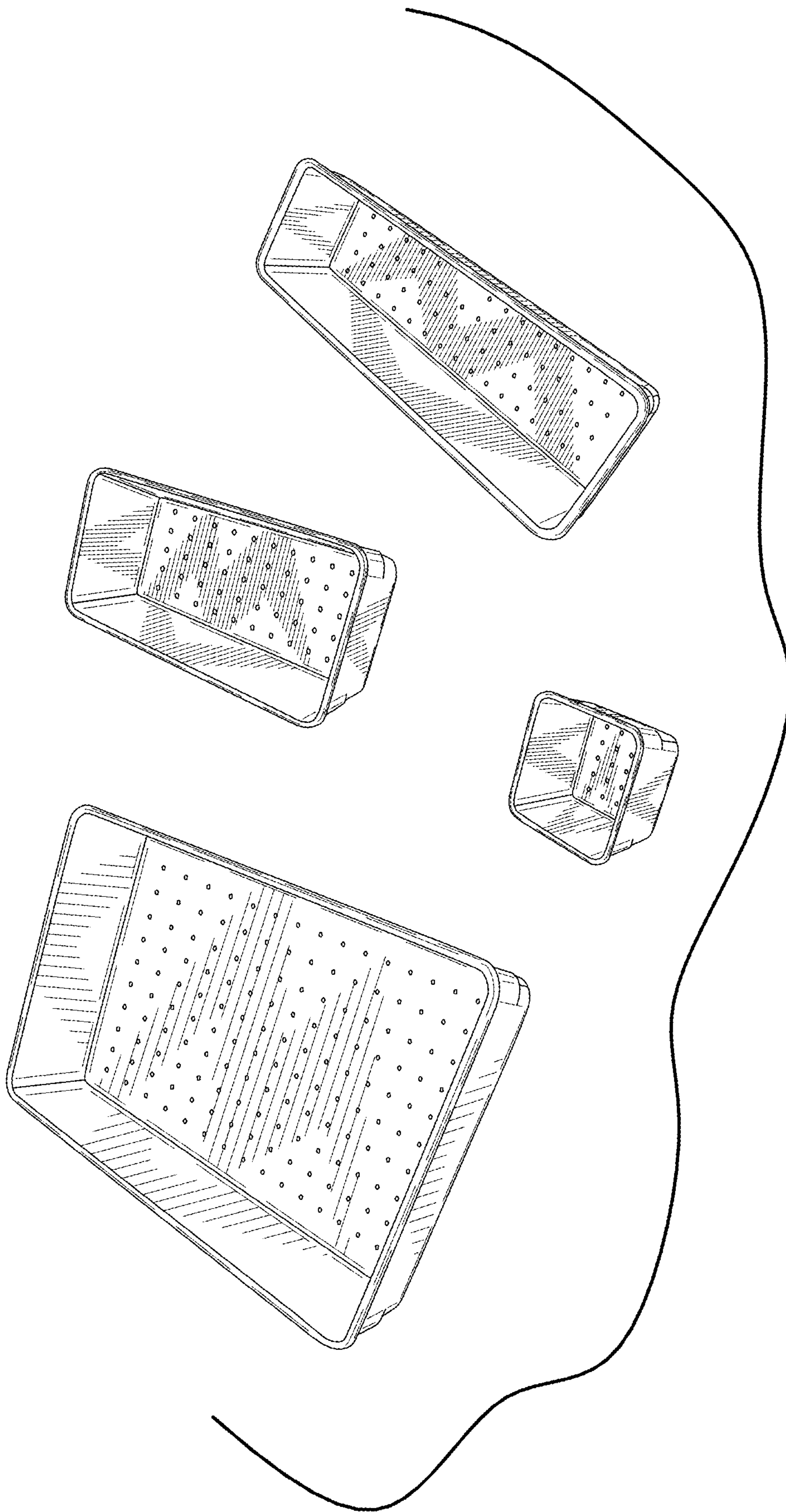

FIG. 1

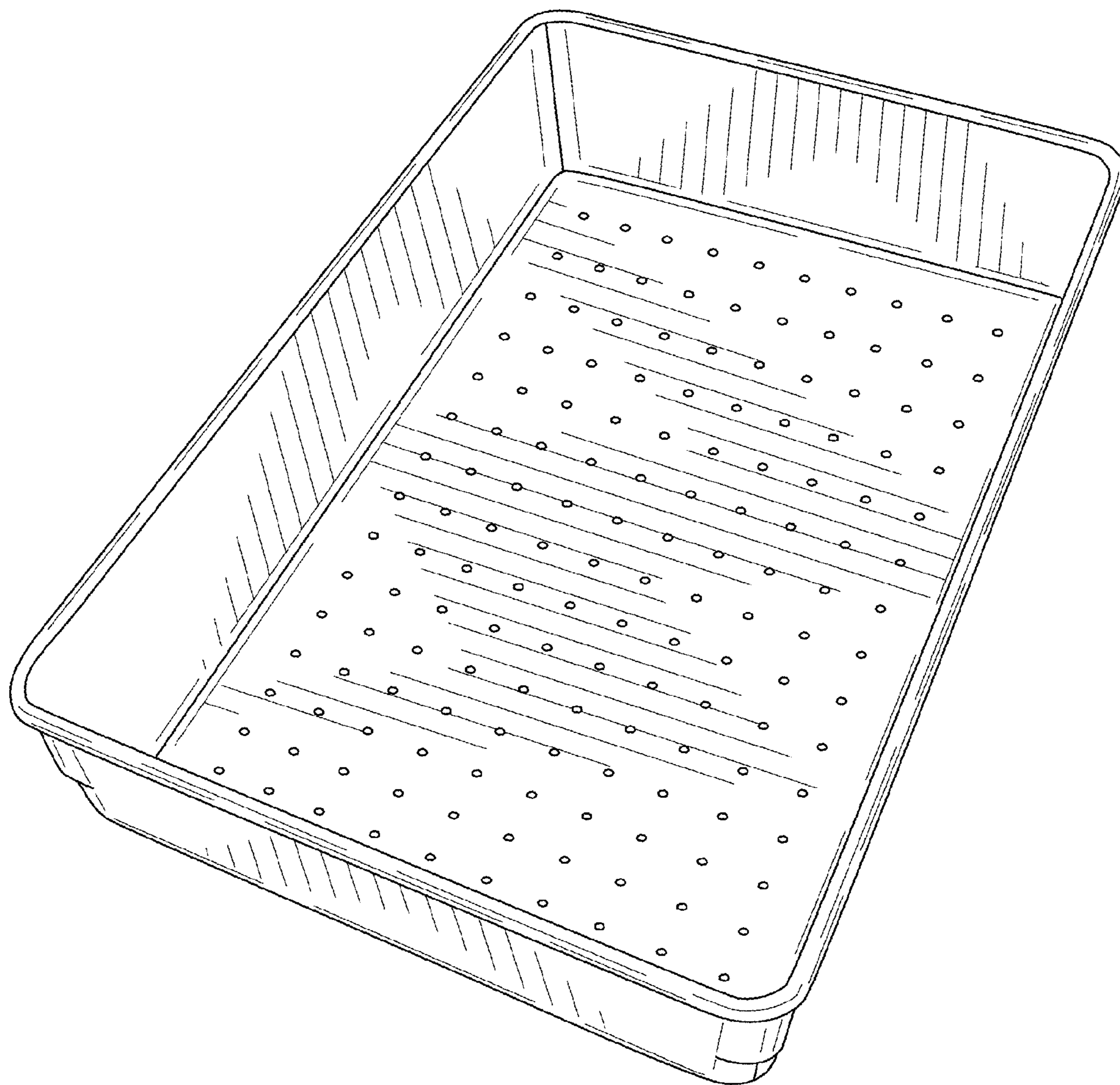

FIG. 2

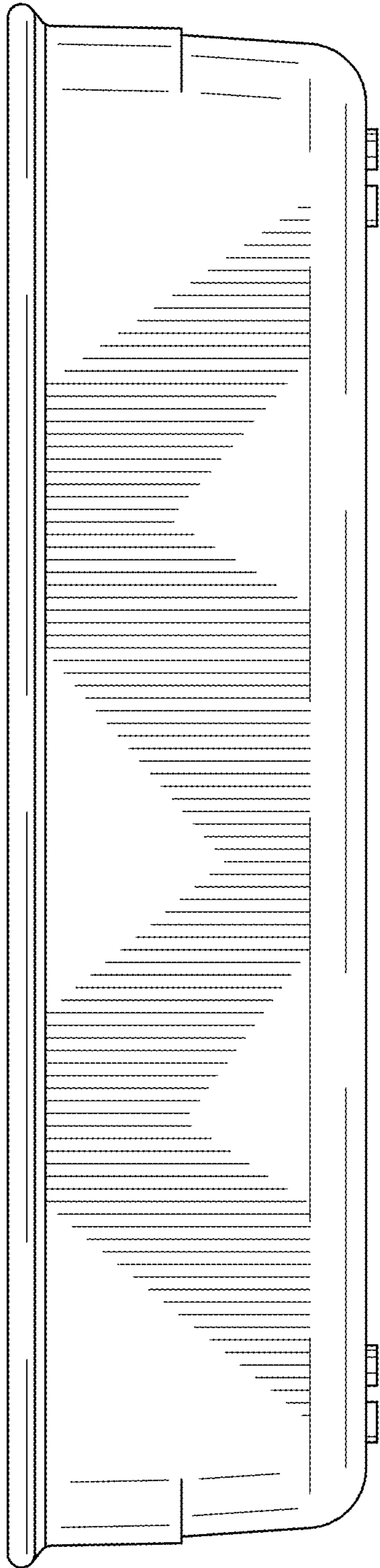

FIG. 3

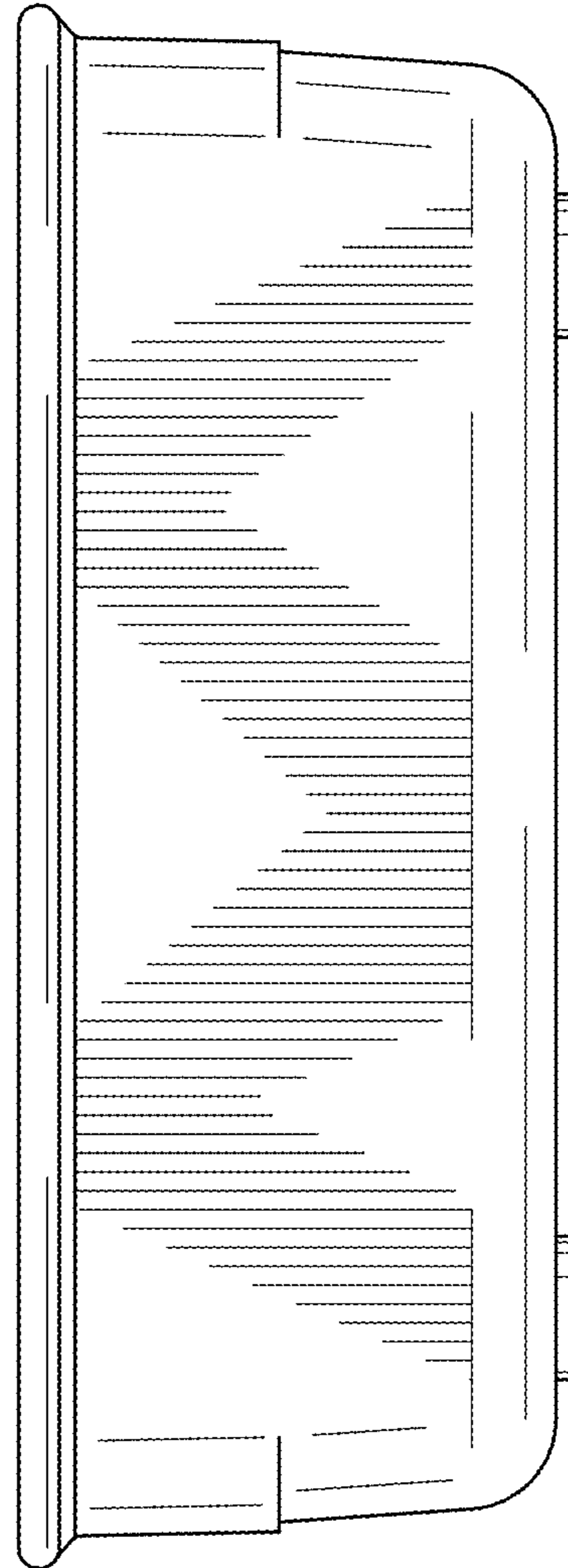

FIG. 4

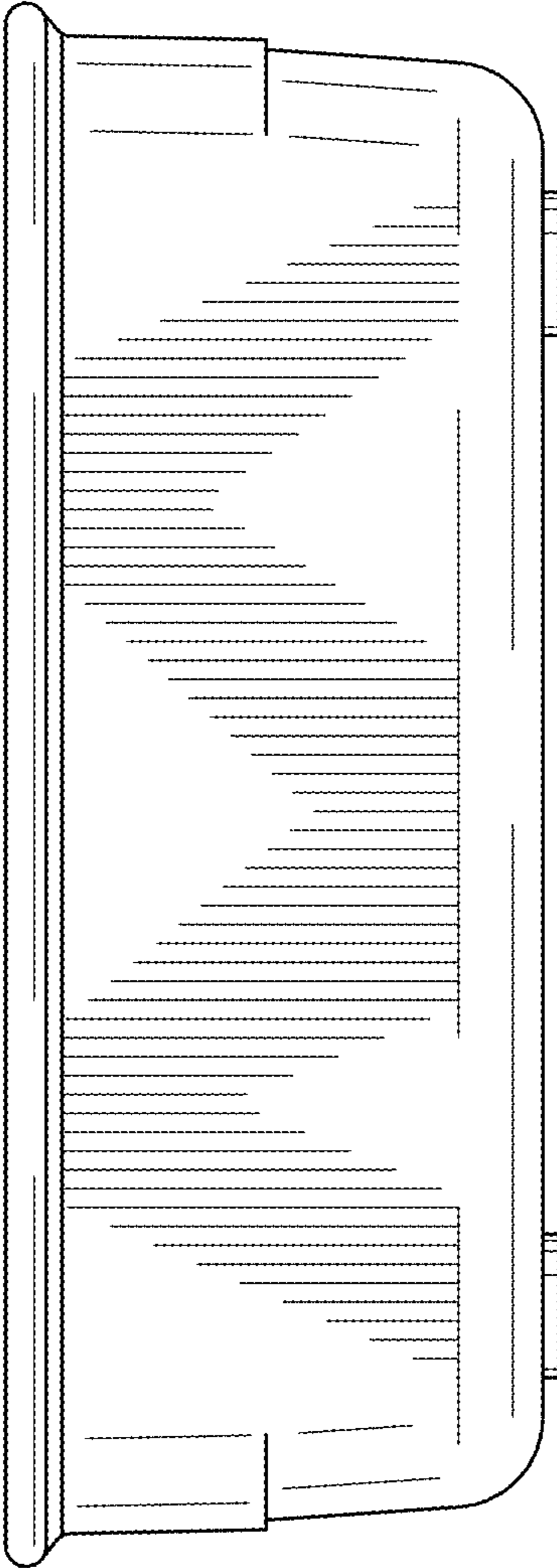

FIG. 5

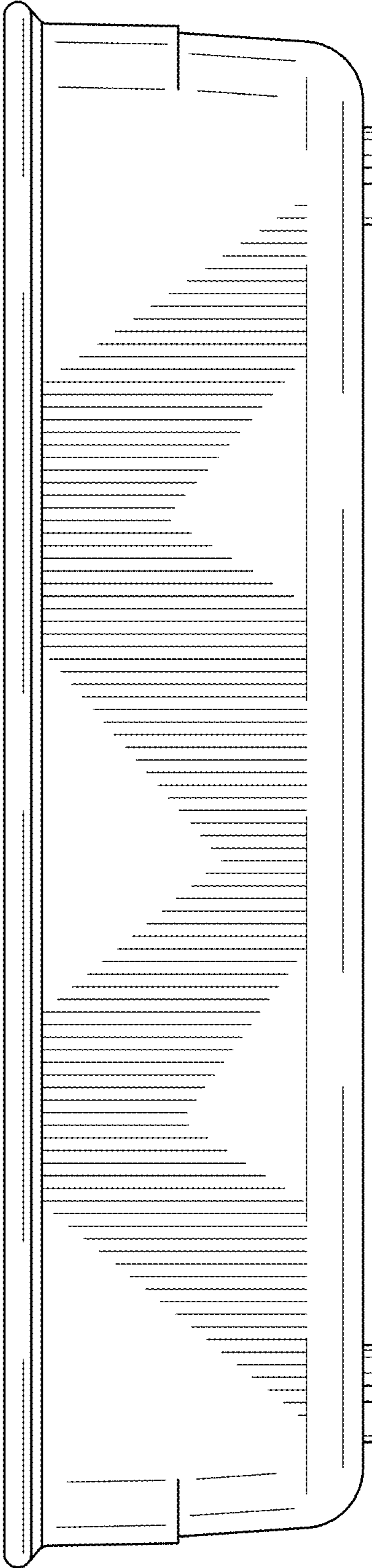

FIG. 6

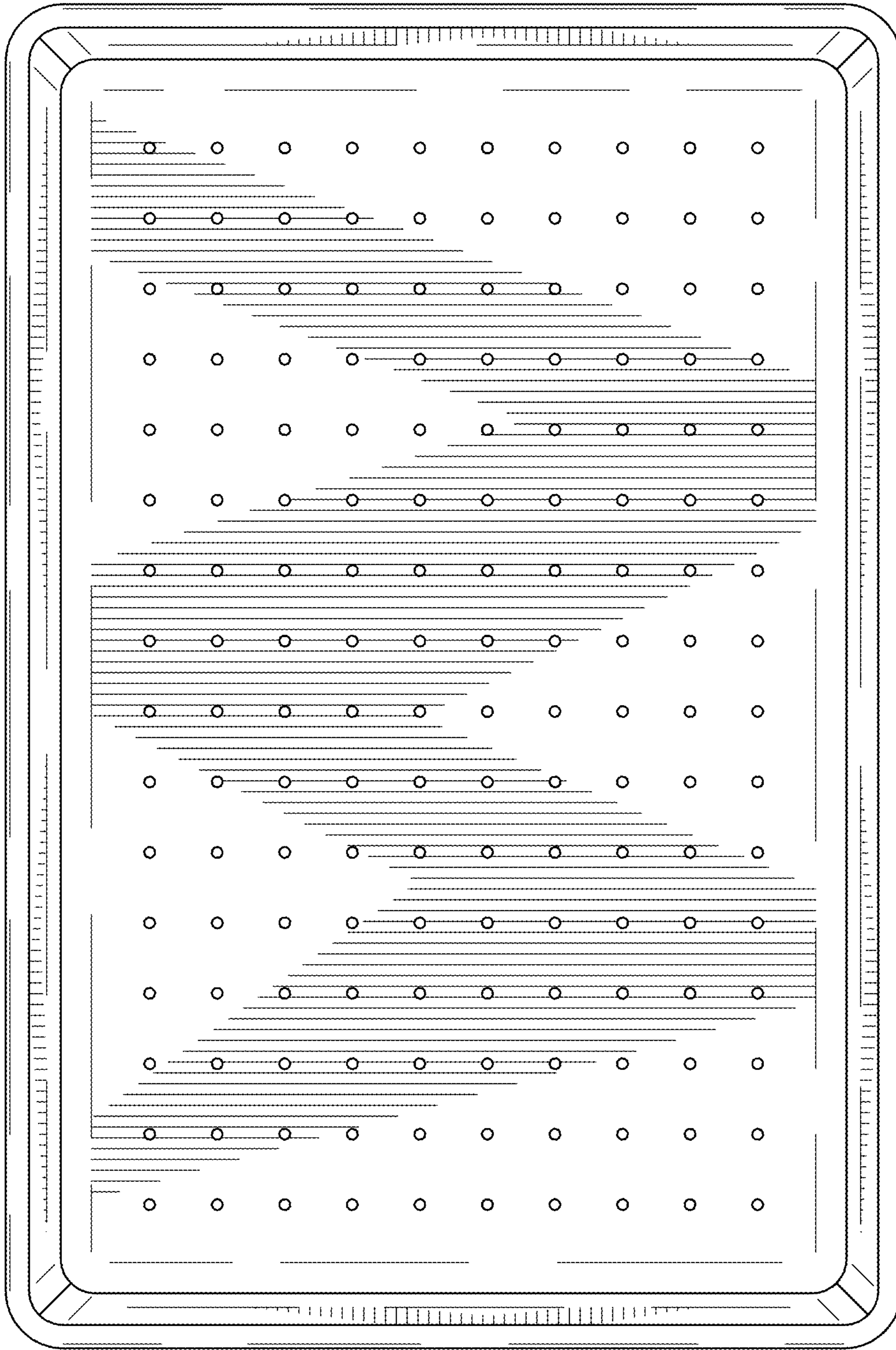

FIG. 7

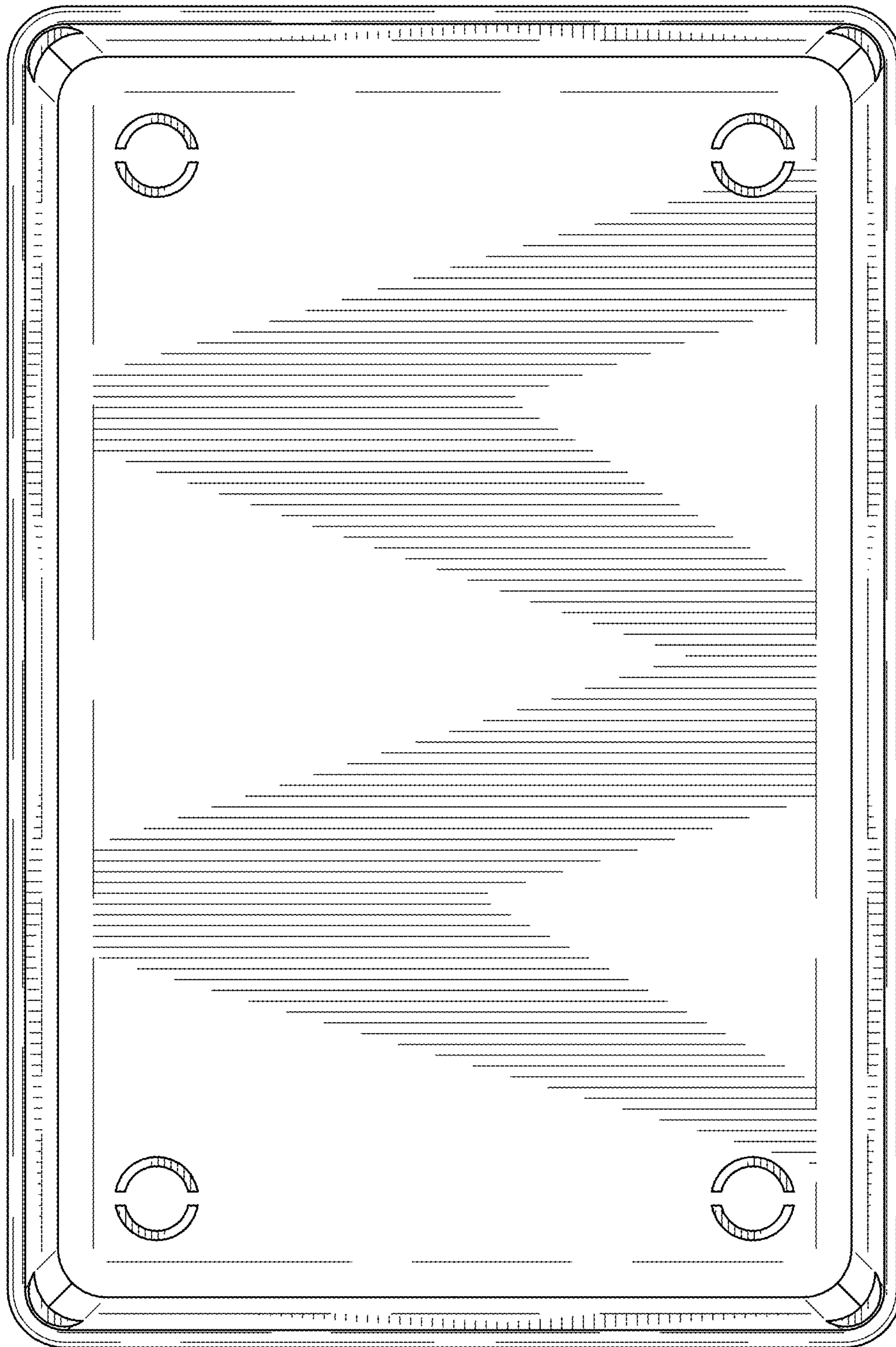

FIG. 8

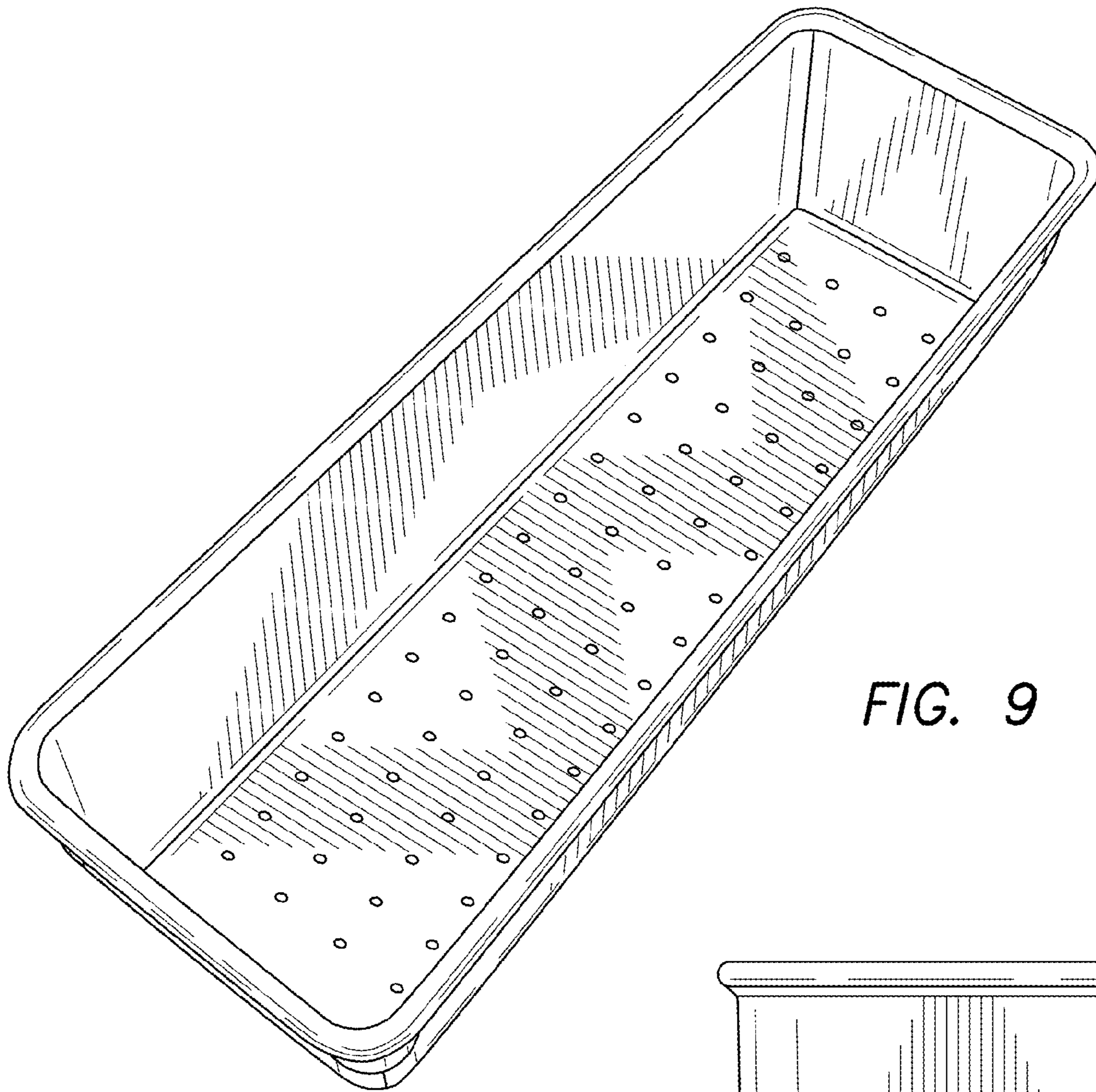

FIG. 9

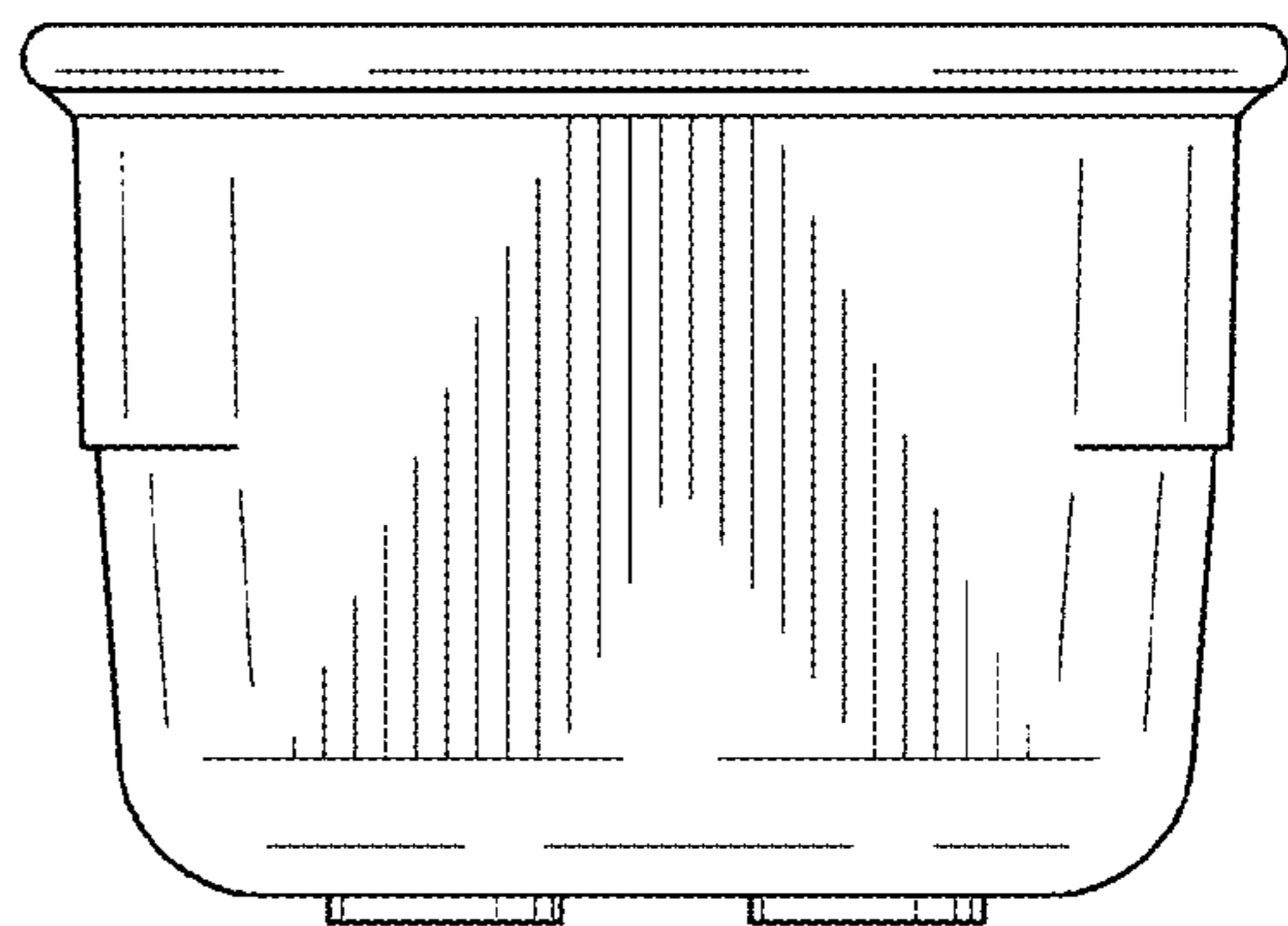

FIG. 10

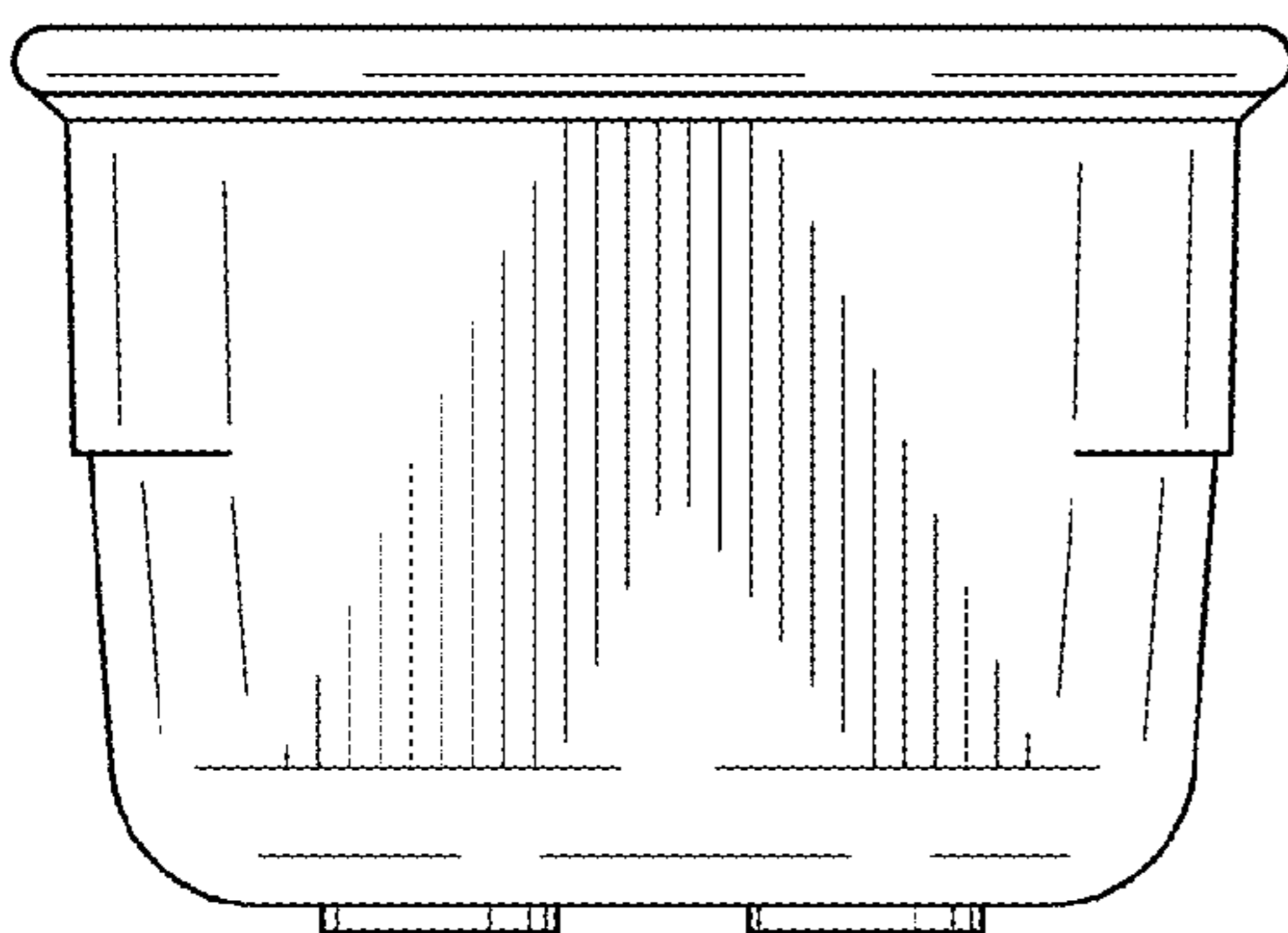

FIG. 11

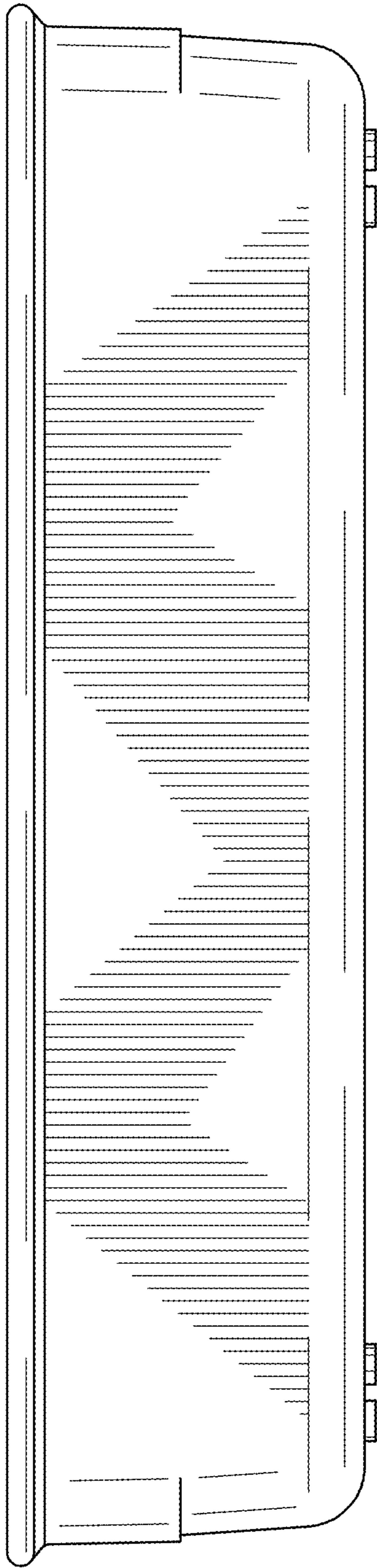

FIG. 12

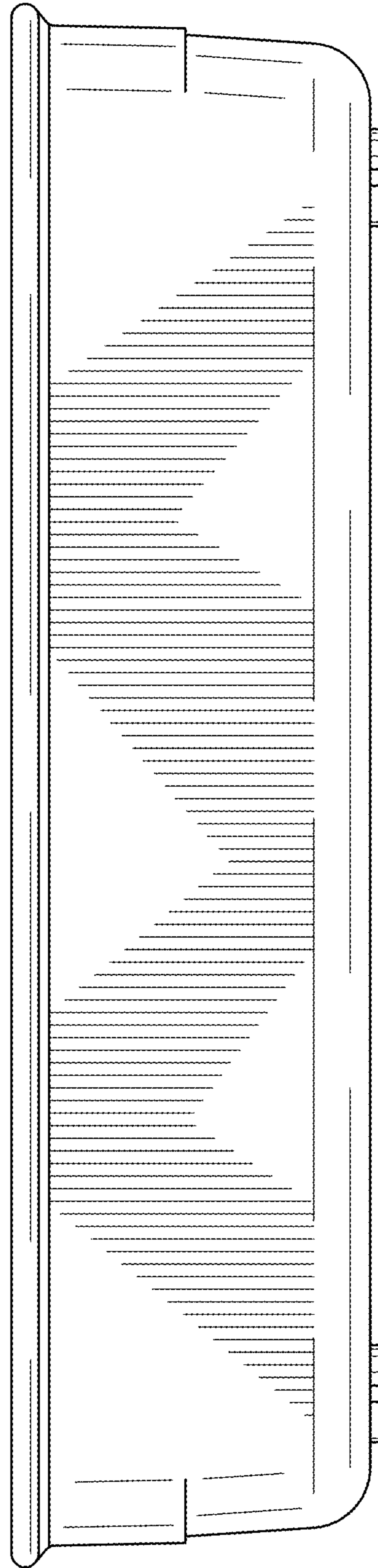

FIG. 13

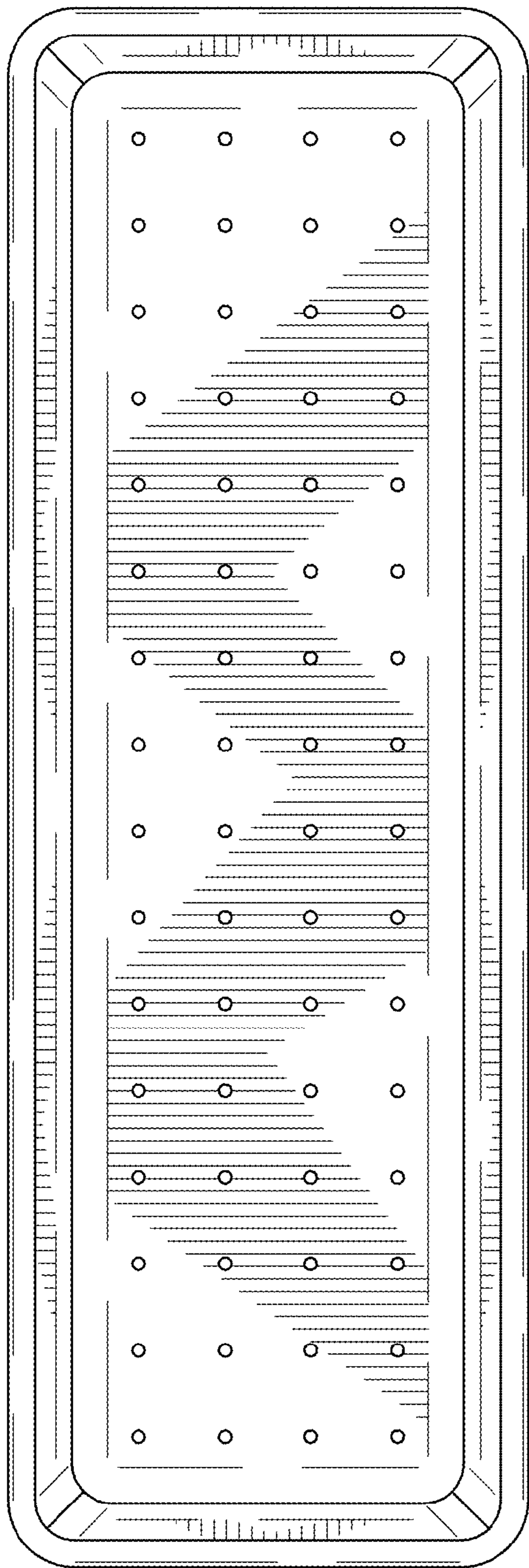

FIG. 14

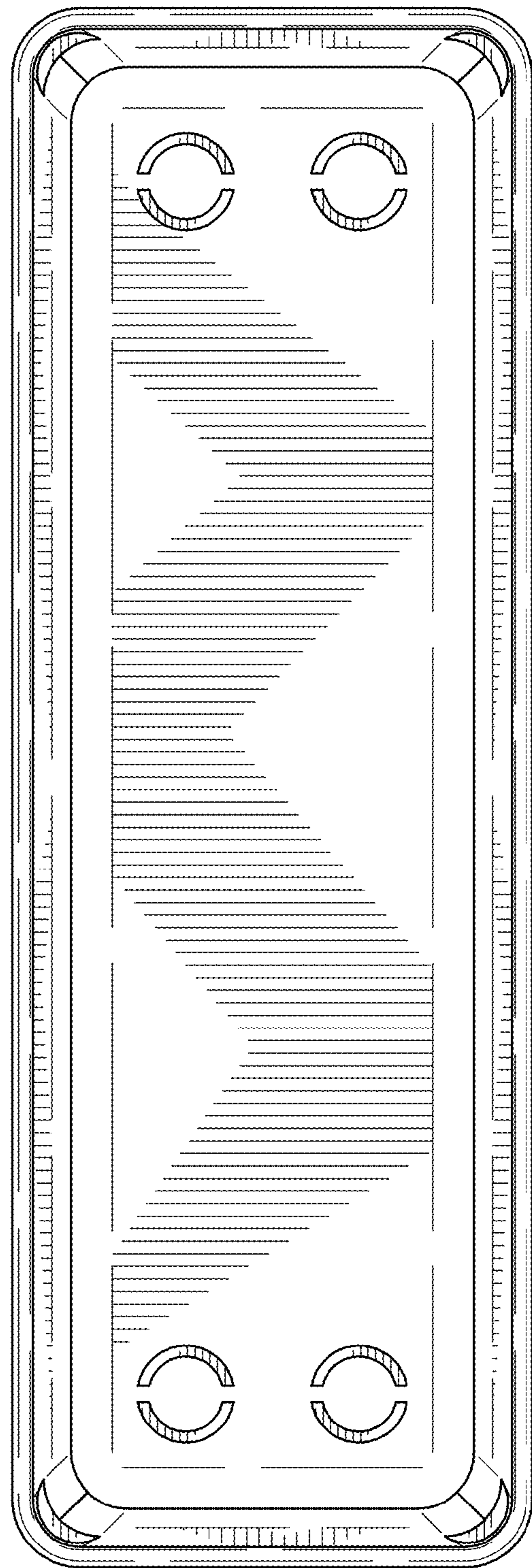

FIG. 15

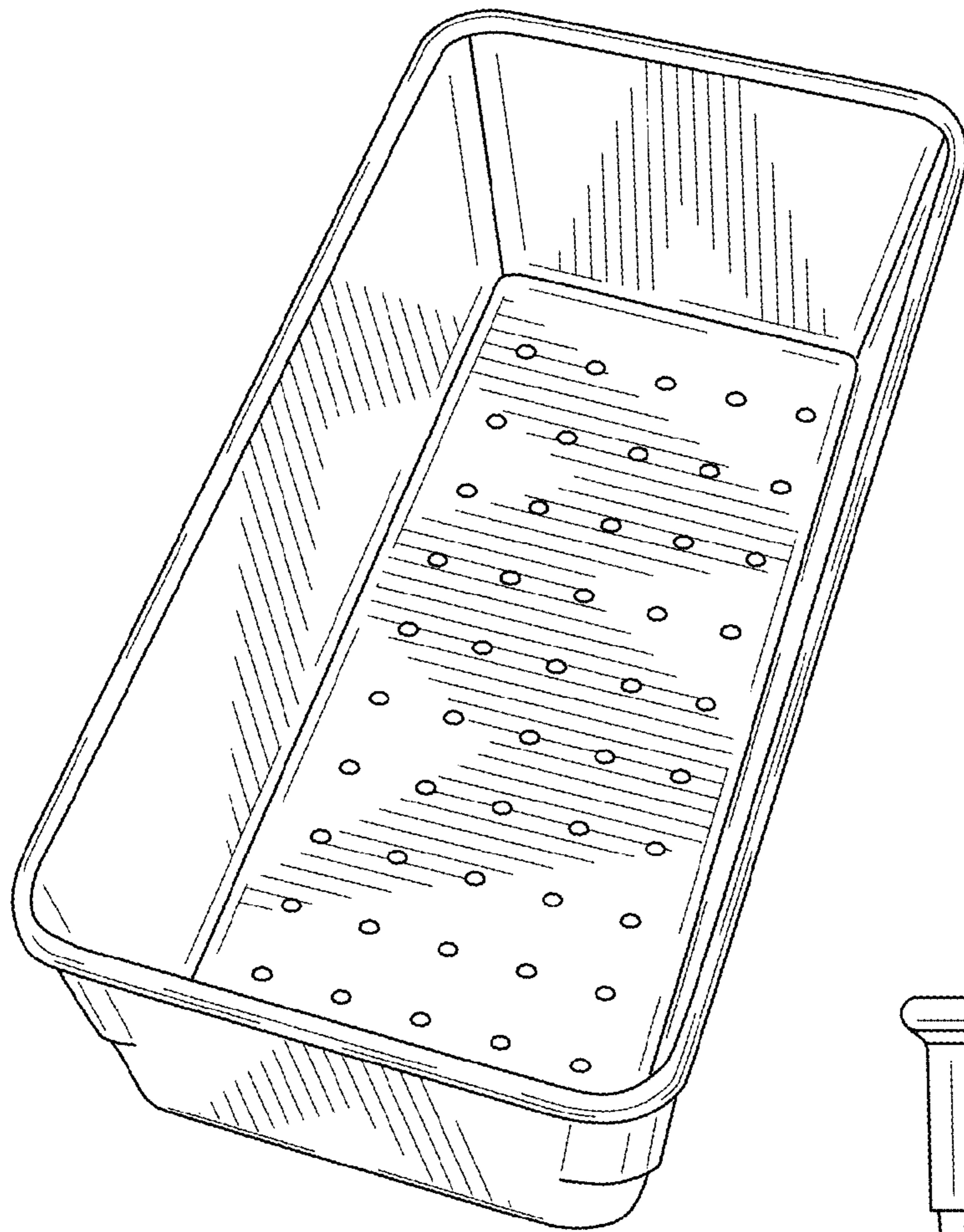

FIG. 16

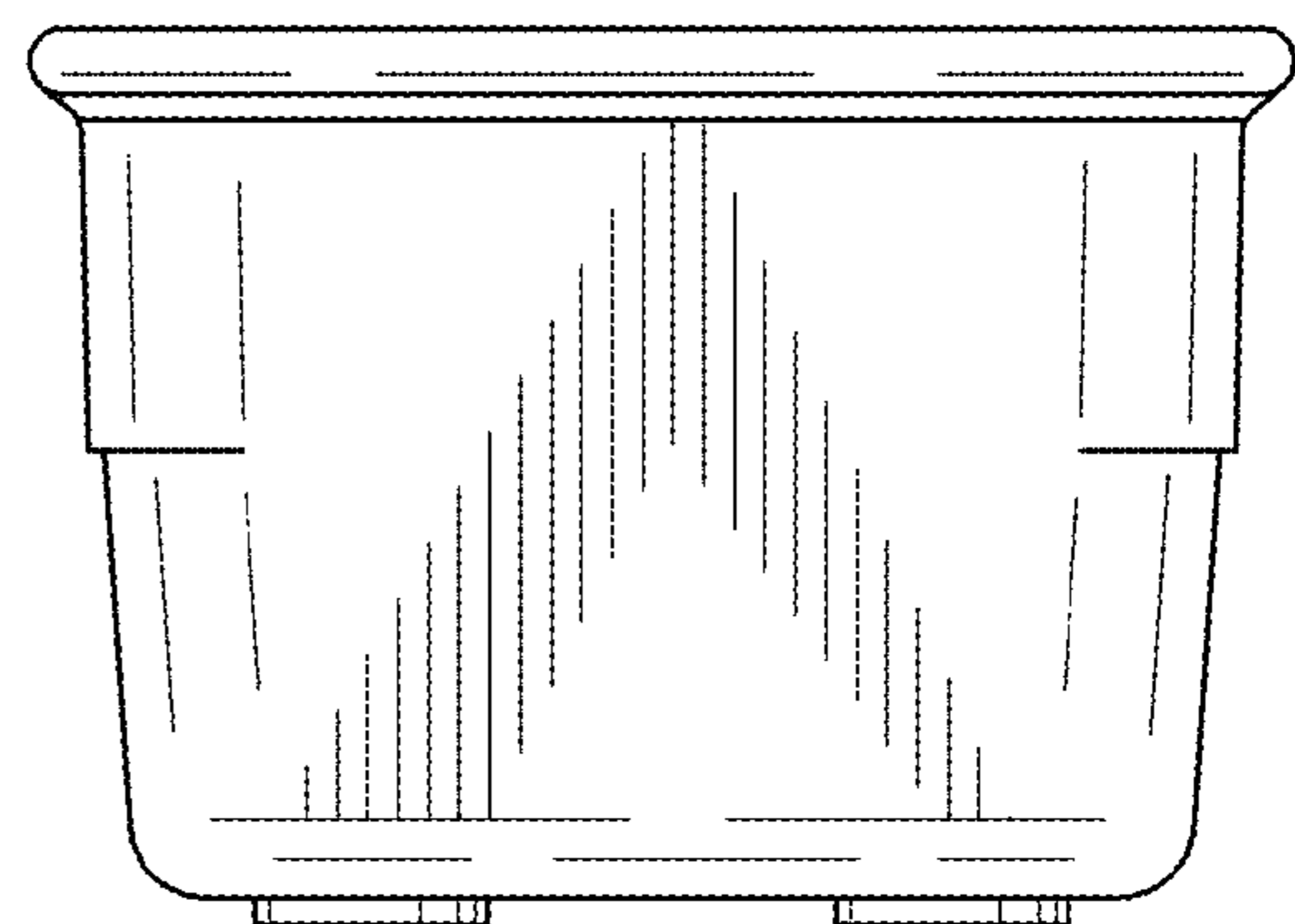

FIG. 17

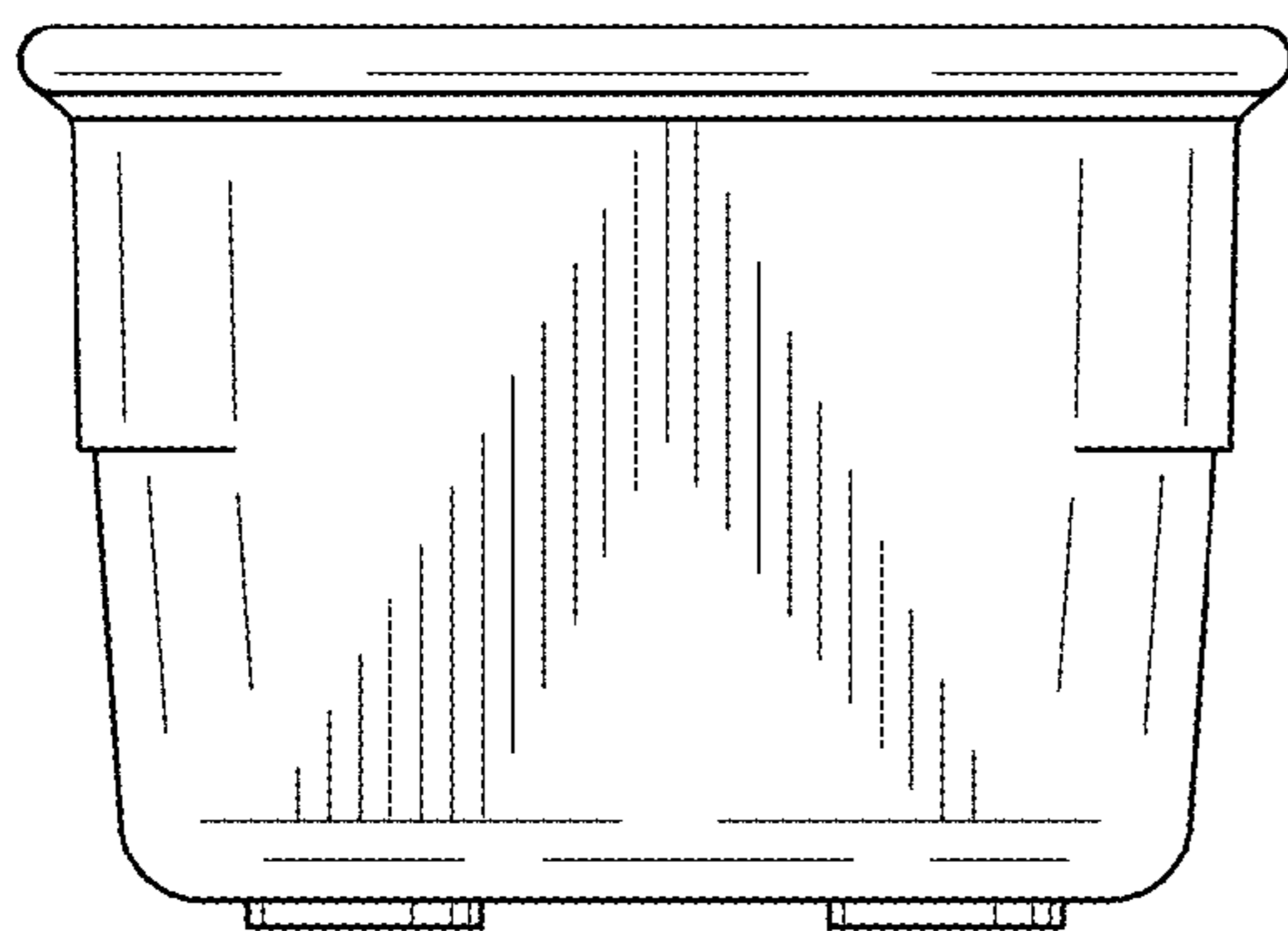

FIG. 18

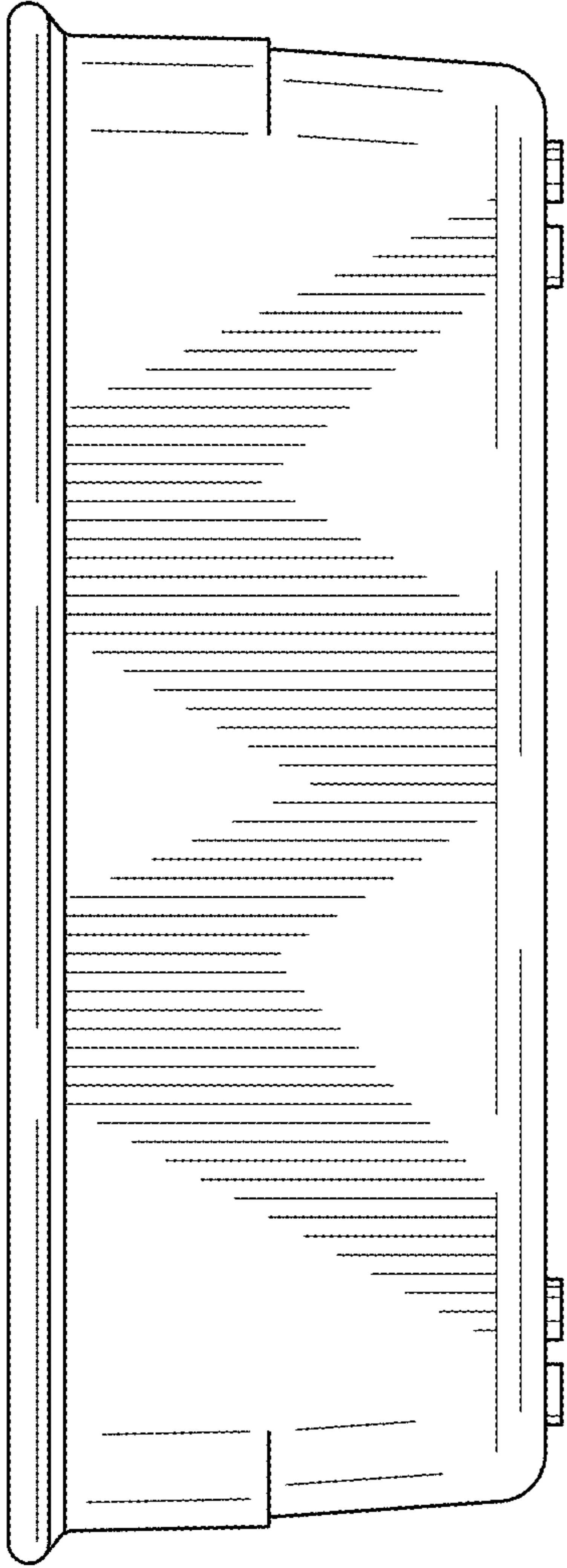

FIG. 19

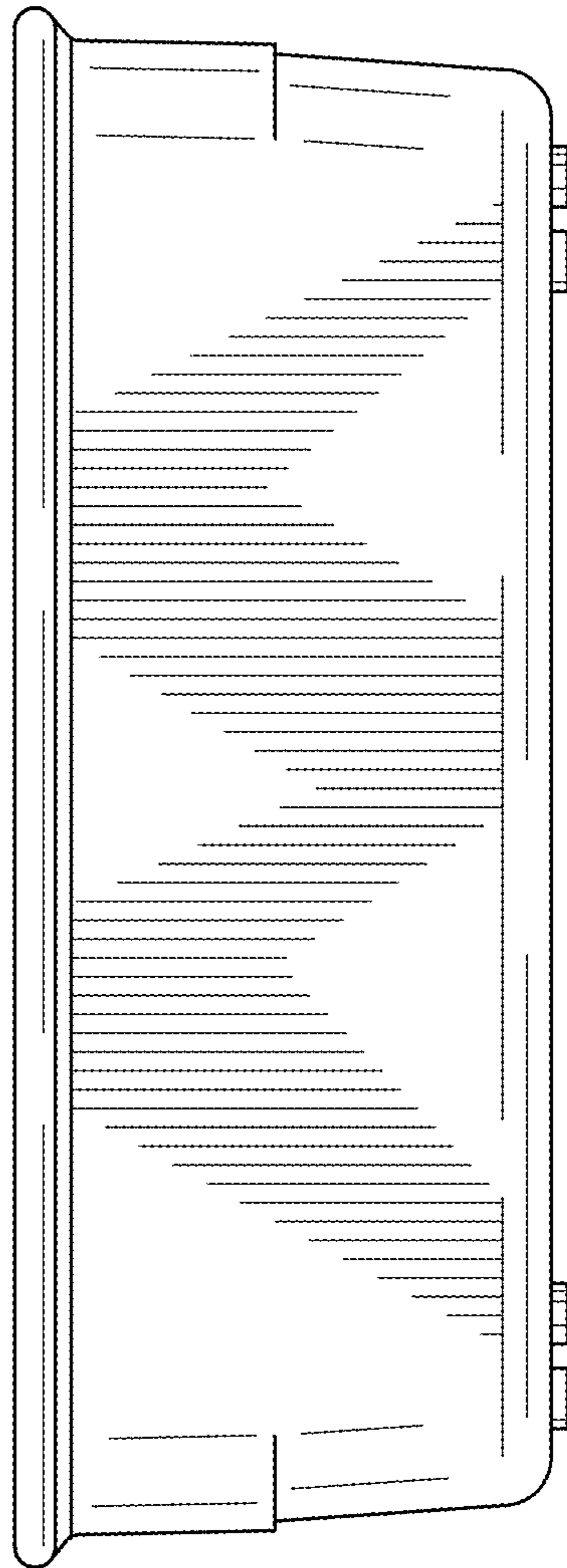

FIG. 20

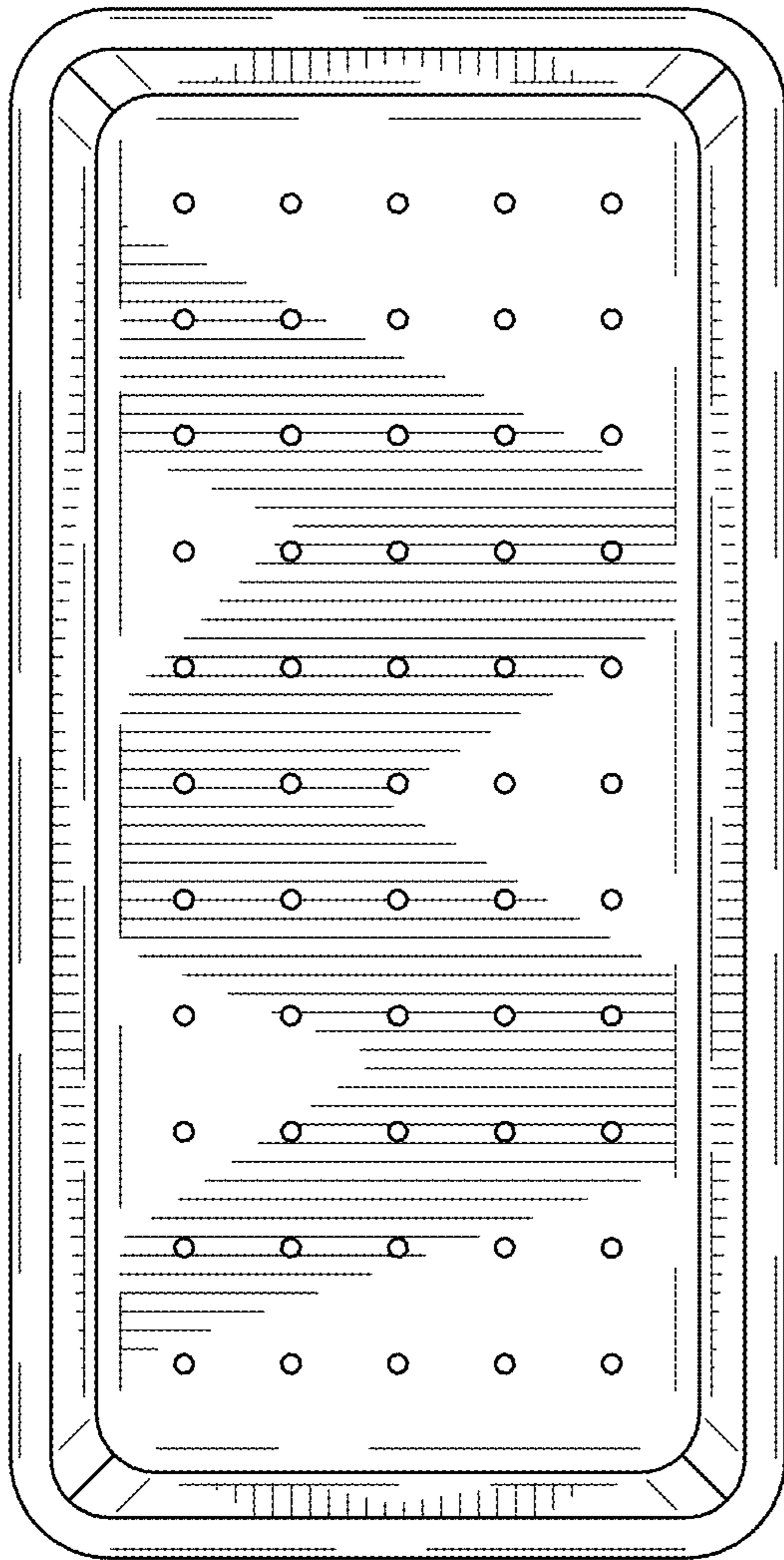

FIG. 21

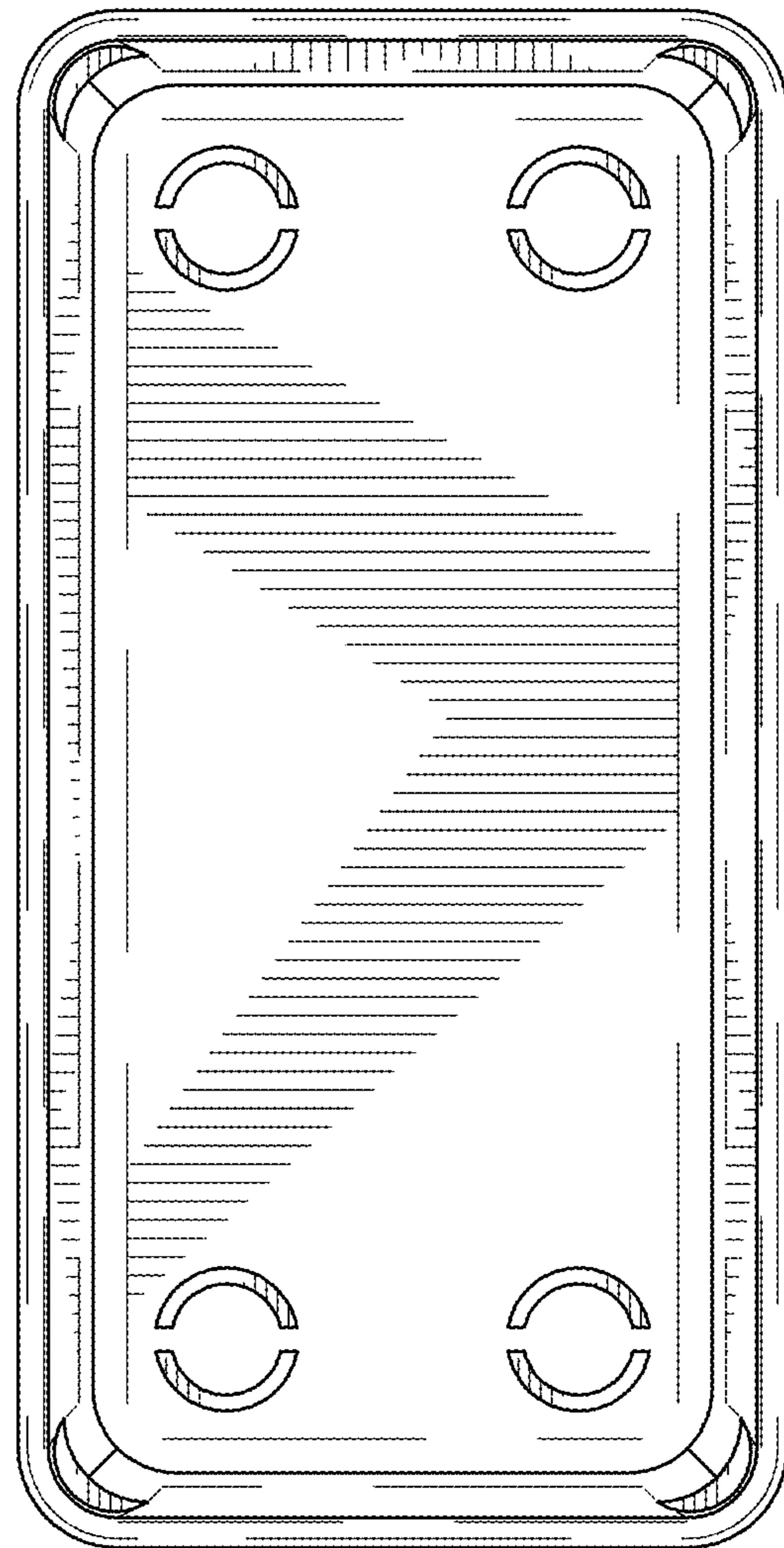

FIG. 22

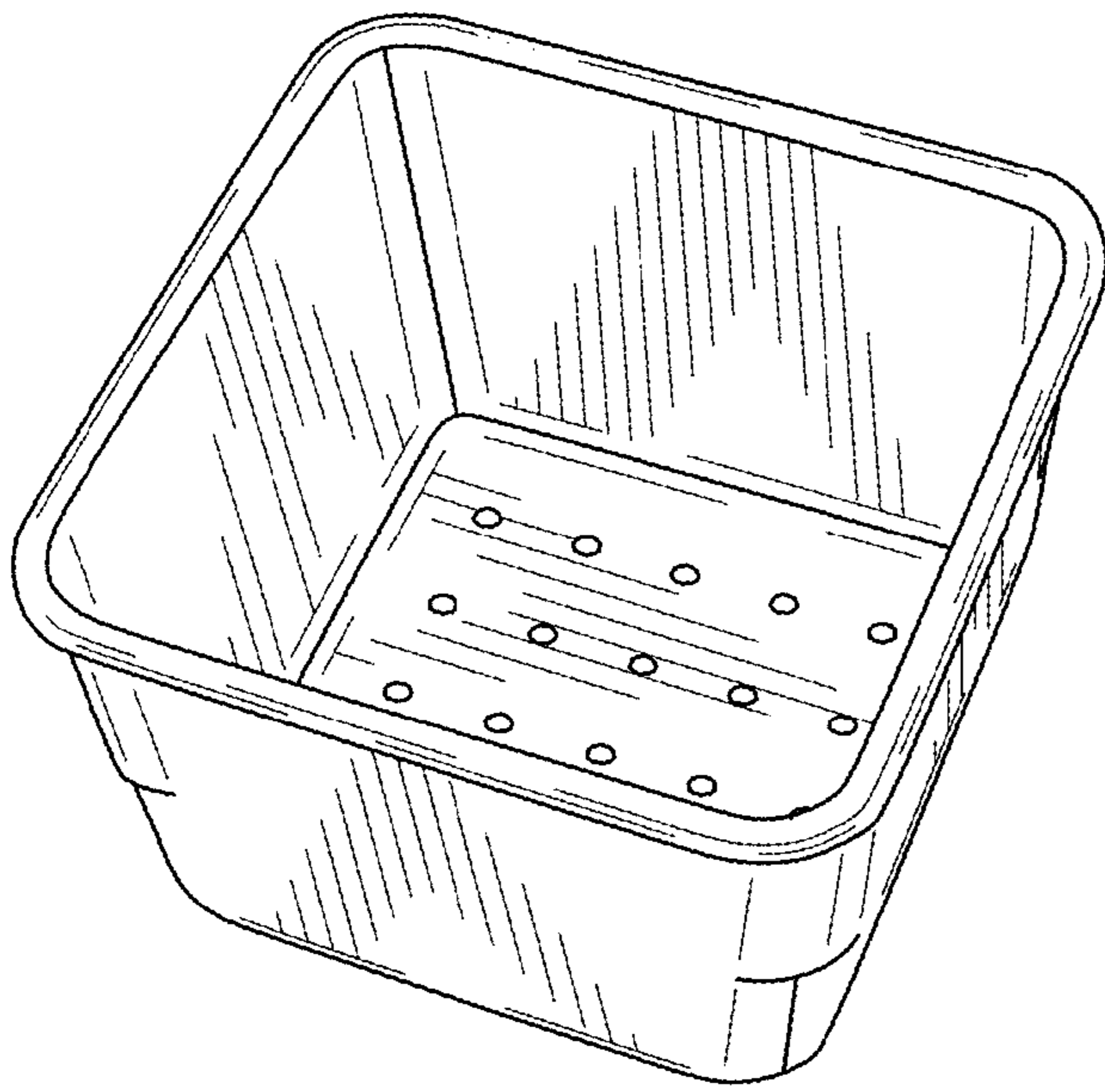

FIG. 23

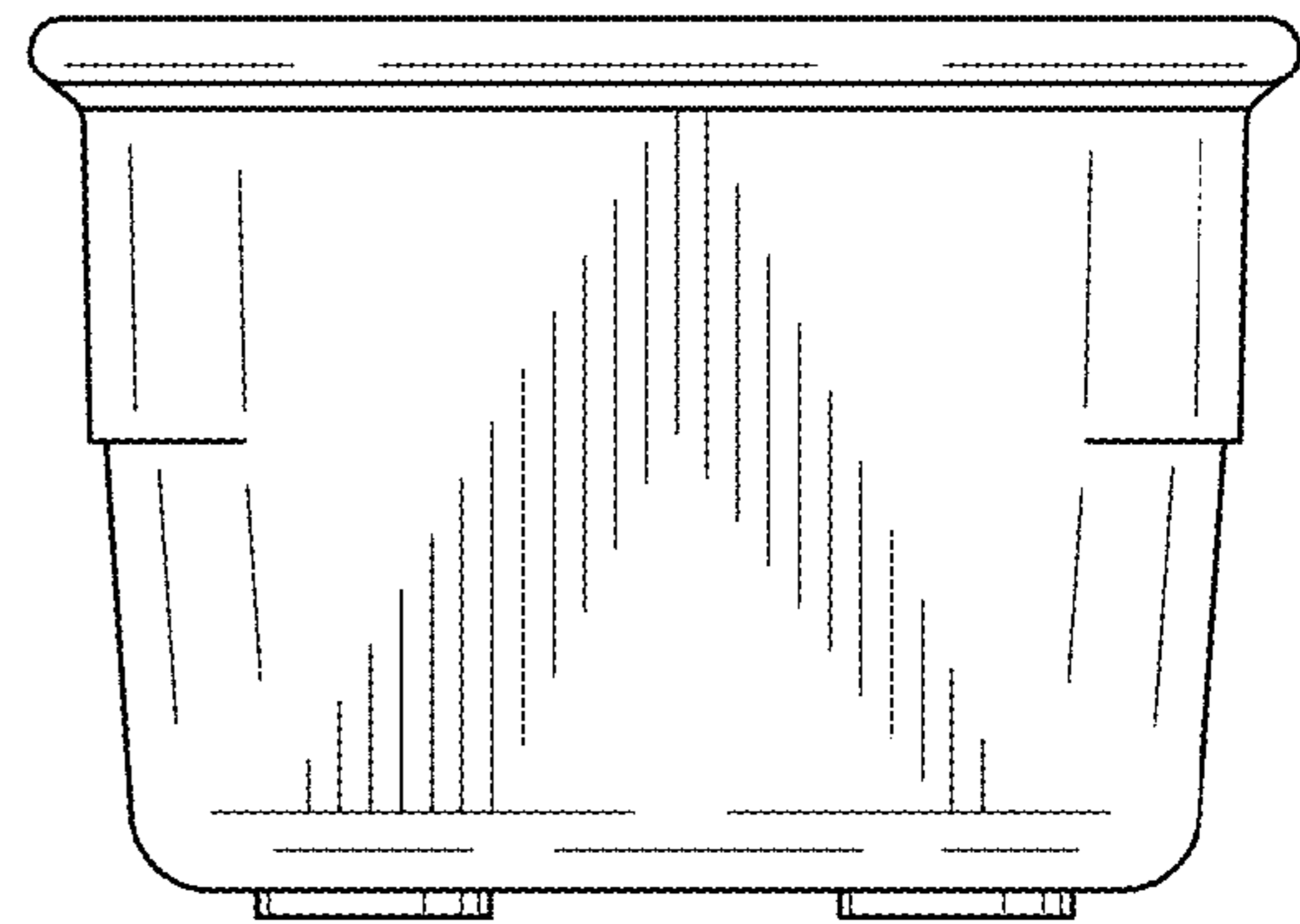

FIG. 24

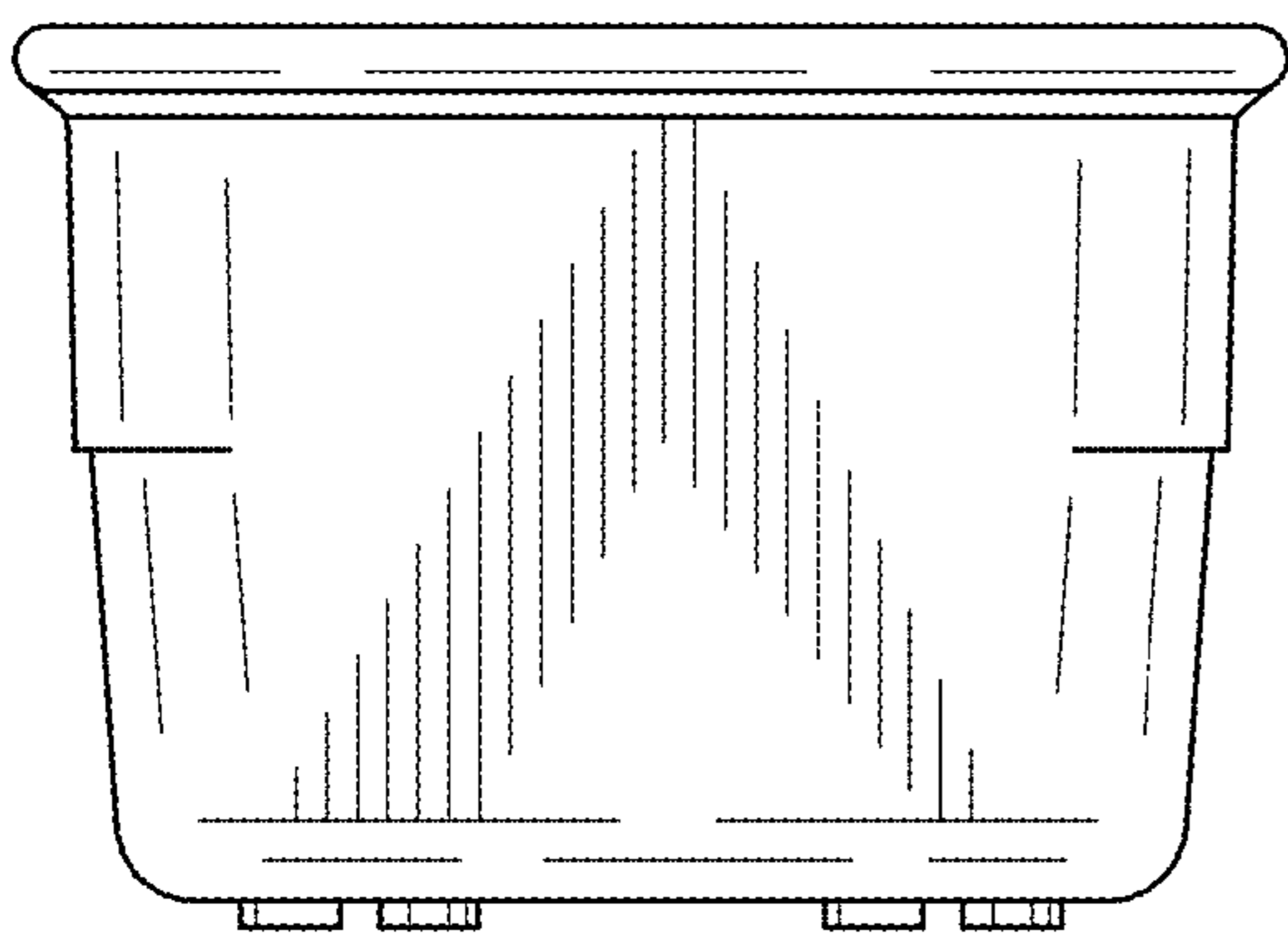

FIG. 25

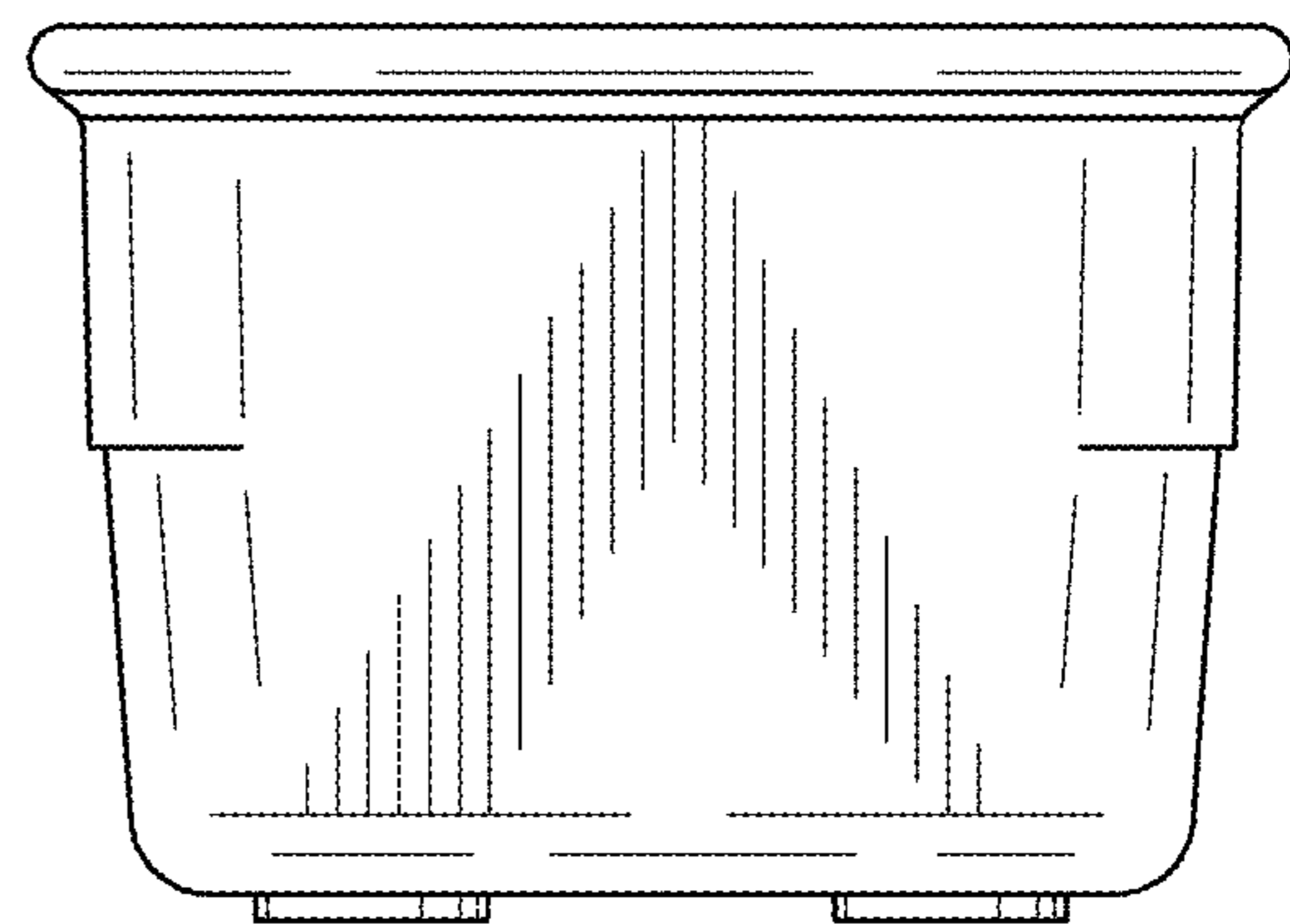

FIG. 26

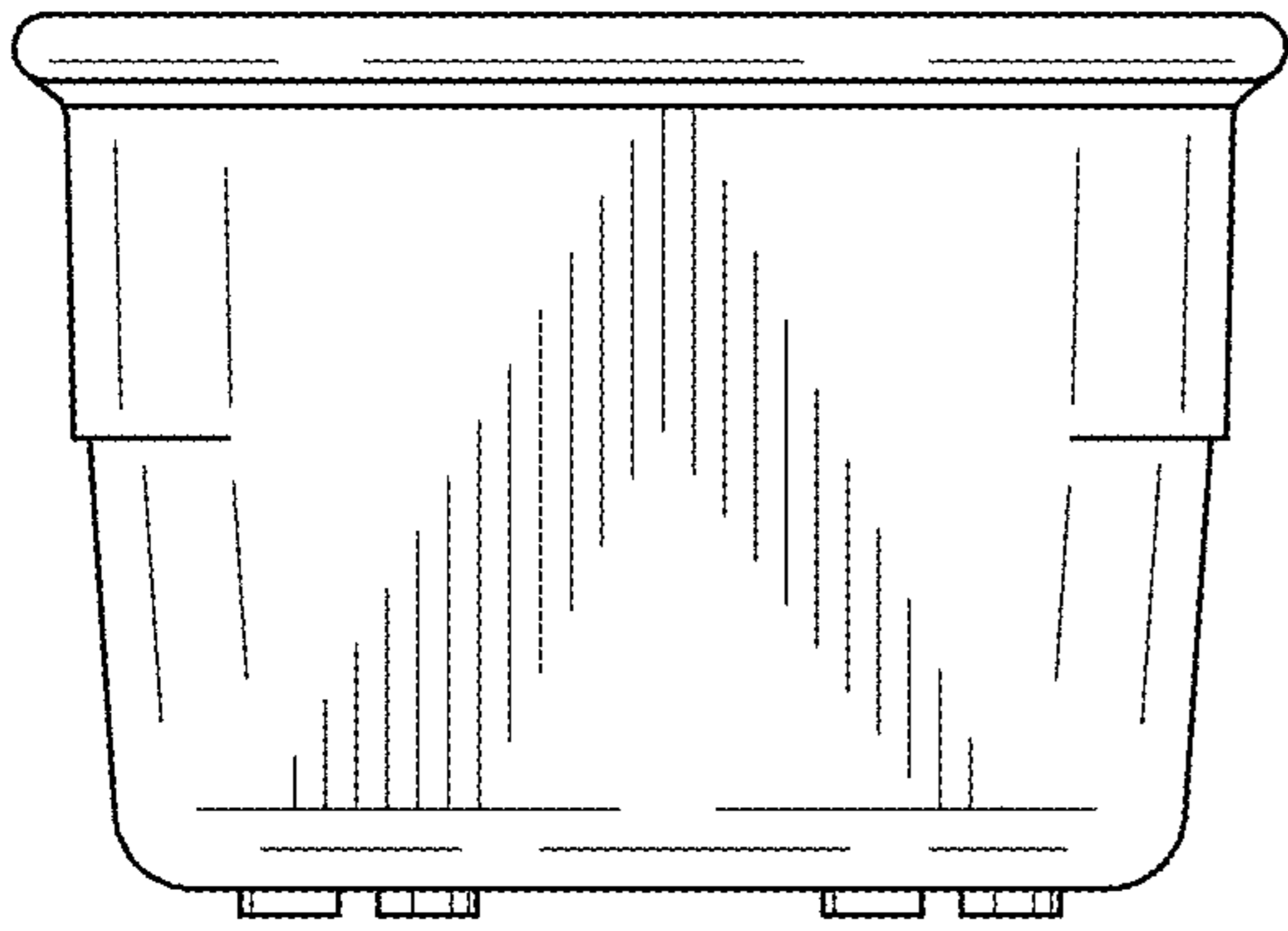

FIG. 27

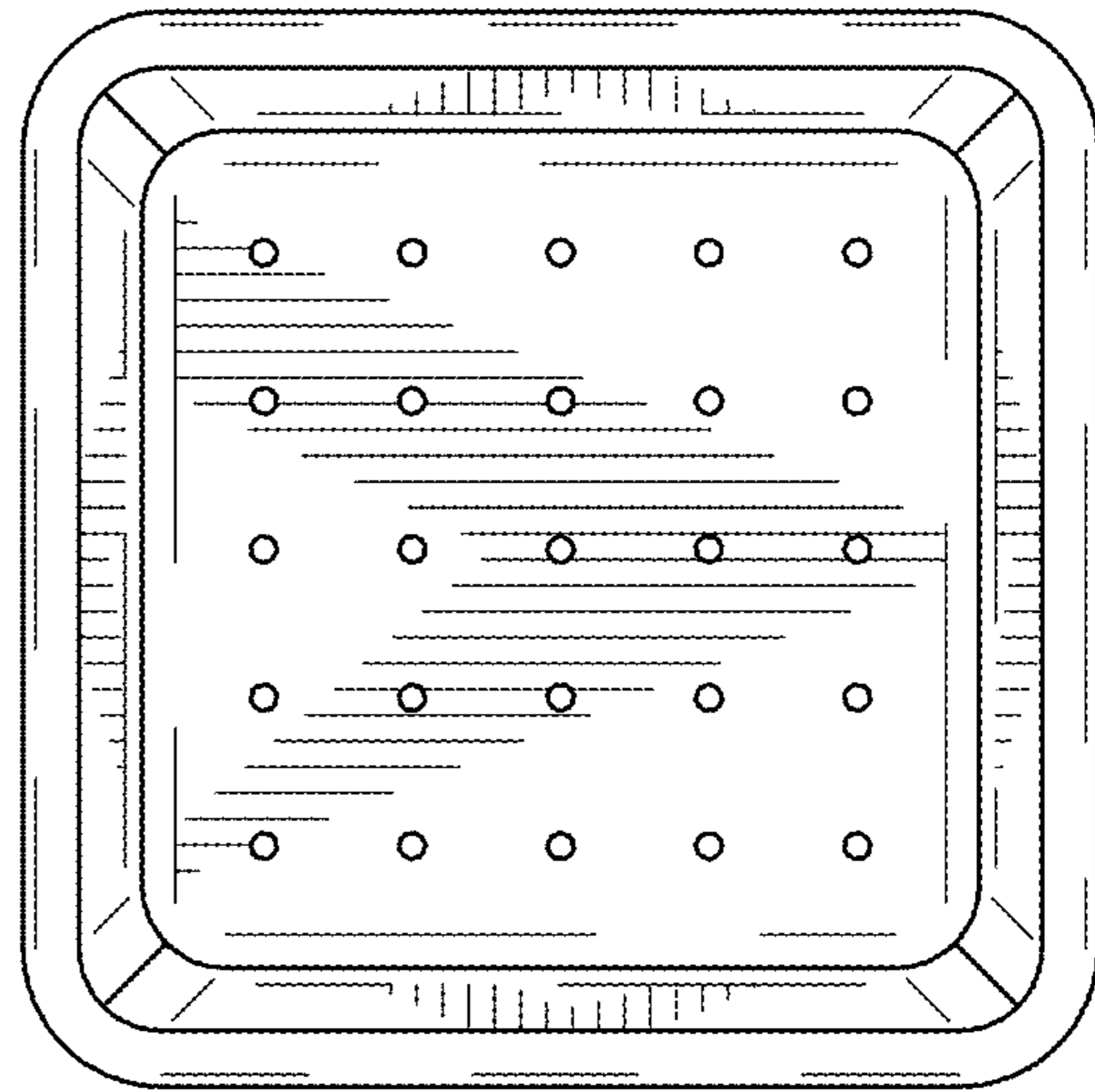

FIG. 28

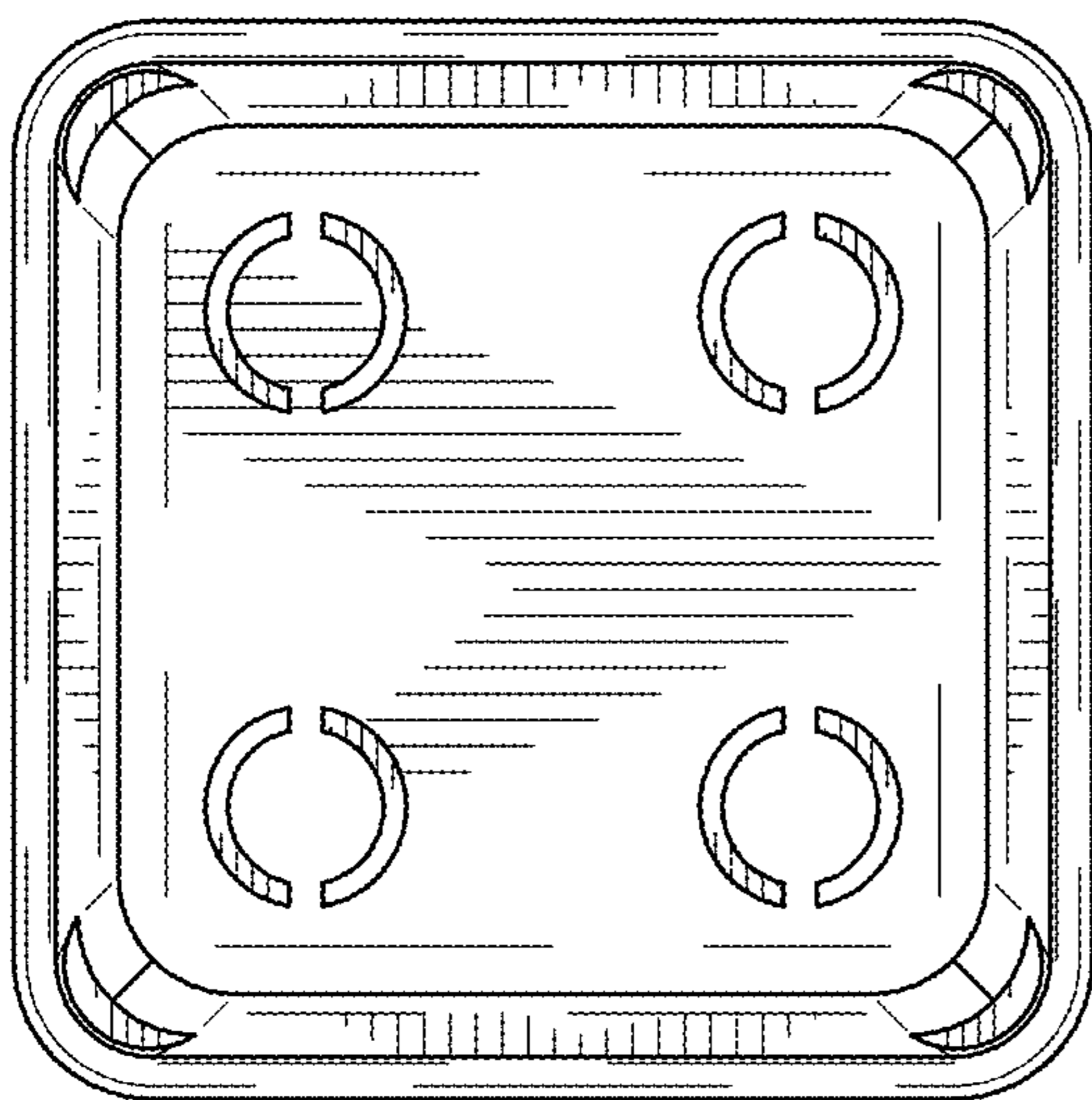

FIG. 29