



US00D945762S

(12) **United States Design Patent**
Ayeti

(10) **Patent No.:** **US D945,762 S**
(45) **Date of Patent:** **** Mar. 15, 2022**

(54) **SNEAKER**

(71) Applicant: **Emmanuel Ayeti**, Baltimore, MD (US)

(72) Inventor: **Emmanuel Ayeti**, Baltimore, MD (US)

(**) Term: **15 Years**

(21) Appl. No.: **29/745,572**

(22) Filed: **Aug. 6, 2020**

(51) **LOC (13) Cl.** **02-04**

(52) **U.S. Cl.**
USPC **D2/969**

(58) **Field of Classification Search**

USPC D2/896, 900, 902, 904, 906–908,
D2/916–924, 925–945, 969, 970–979,
D2/946–962; 36/1.5, 3 A, 83, 45, 99,
36/112–116, 1, 3 B, 22 R, 24.5, 25 R, 28,
36/32 R, 34 R, 59 C, 67 A, 101–107,
36/117.3, 117.4, 124–136
CPC A43B 23/00; A43B 23/02; A43B 23/04;
A43B 23/07; A43B 23/024; A43B
23/0245; A43B 23/025; A43B 23/026;
A43B 23/265; A43B 23/14; A43B 23/16;
A43B 23/24; A43B 23/26; A43B 5/00;
A43B 5/001; A43B 5/002; A43B 5/003;
A43B 5/008; A43B 5/06; A43B 5/08;
A43B 5/10; A43B 5/12; A43B 5/14;
A43B 5/145; A43B 1/00; A43B 1/02;
A43B 1/04; A43B 1/0045; A43B 3/12;
A43B 7/00; A43B 9/00; A43B 9/08;
A43B 9/14; A43B 9/16; A43B 11/00;
A43B 21/00; A43B 21/02; A43B 21/04;
A43B 21/06; A43B 13/00; A43B 13/02;
A43B 13/023; A43B 13/026; A43B
13/04; A43B 13/08; A43B 13/10; A43B
13/12; A43B 13/14; A43B 13/141; A43B
13/143; A43B 13/16; A43B 13/18; A43B
13/181; A43B 13/187; A43B 13/189;
A43B 13/20; A43B 13/22; A43B 13/223;
A43B 13/24; A43B 13/28; A43B 13/30;
A43B 13/32; A43B 13/34; A43B 13/36;

(Continued)

(56) **References Cited**

U.S. PATENT DOCUMENTS

D369,459 S * 5/1996 Feller D2/969
5,806,208 A * 9/1998 French A43B 7/02
36/28

(Continued)

OTHER PUBLICATIONS

Maxwell Design Shop, AskForFunding.com, [online], [site visited Aug. 30, 2021], <URL: <https://askforfunding.com/business/maxwell-design-shop>> (Year: 2021).*

(Continued)

Primary Examiner — T Chase Nelson
Assistant Examiner — Jonathan J Han

(57) **CLAIM**

The ornamental design for a sneaker, as shown and described.

DESCRIPTION

FIG. 1 is a front-top-left perspective view of a sneaker showing my new design;
FIG. 2 is a rear-bottom-right perspective view thereof;
FIG. 3 is a front elevation view thereof;
FIG. 4 is a rear elevation view thereof;
FIG. 5 is a top plan view thereof;
FIG. 6 is a bottom plan view thereof;
FIG. 7 is a right side elevation view thereof; and,
FIG. 8 is a left side elevation view thereof.

The broken lines in the drawings depicting the tongue and laces in FIGS. 1-5 and 7-8, the port and battery in FIGS. 2 and 7, threading in FIGS. 1-4 and 6-8, and the bottom surface of the outsole in FIGS. 1-4 and 8-8 are included for the purpose of showing portions of the invention that form no part of the claimed design.

1 Claim, 8 Drawing Sheets

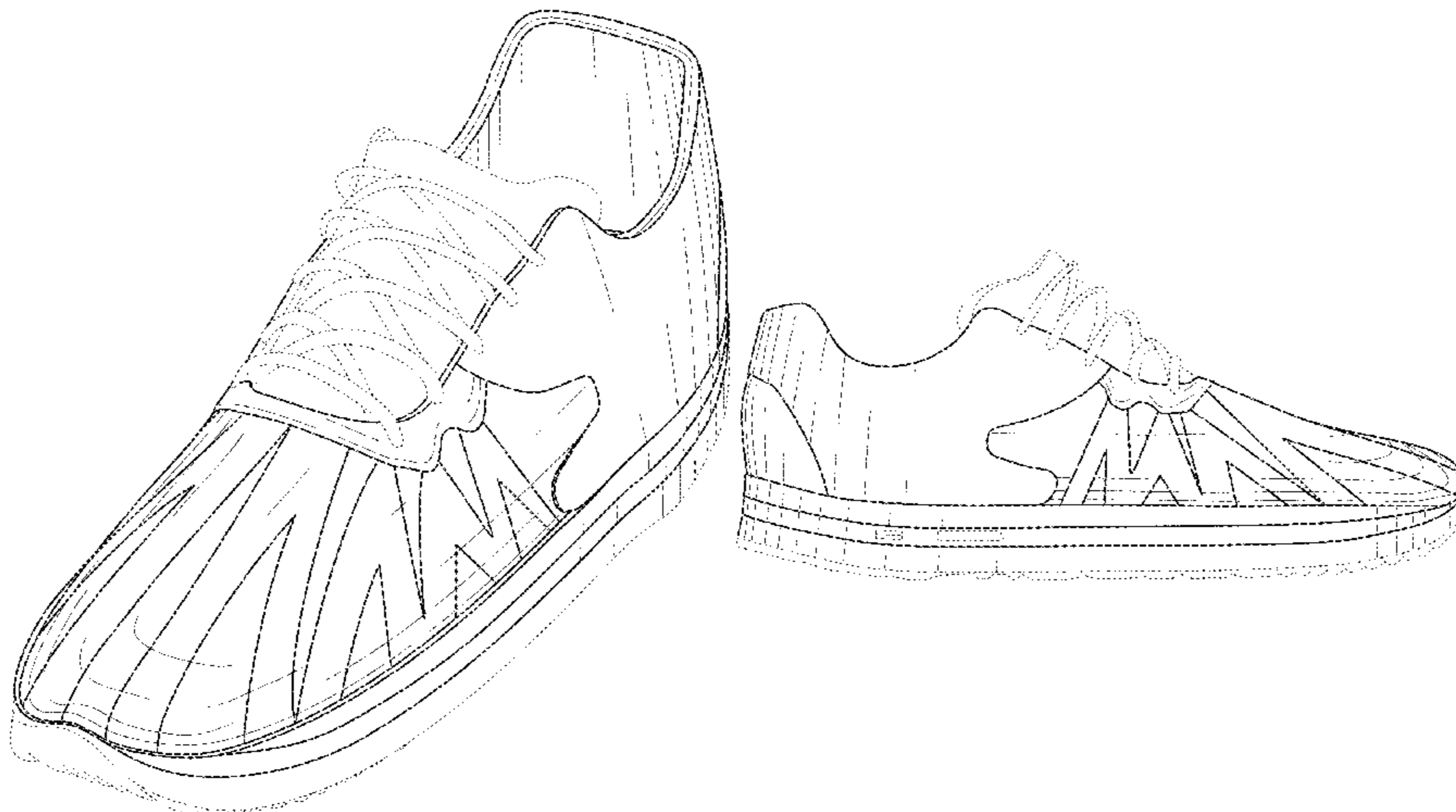

- (58) **Field of Classification Search**
 CPC .. A43C 1/00; A43C 1/003; A43C 1/06; A43C
 3/00; A43C 5/00; A43C 7/00; A43C
 11/00
 See application file for complete search history.

(56) **References Cited**

U.S. PATENT DOCUMENTS

D447,859	S	*	9/2001	Matis	D2/902
D447,860	S	*	9/2001	Matis	D2/902
D575,499	S	*	8/2008	Seamans	D2/972
D593,302	S	*	6/2009	St-Louis	D2/969
D635,346	S	*	4/2011	Lonigan	D2/970
D636,984	S	*	5/2011	Lonigan	D2/970
D639,034	S	*	6/2011	Castellon	D2/912
D658,855	S	*	5/2012	Van Zyll De Jong	D2/911
D658,862	S	*	5/2012	Stryjak	D2/972
D660,570	S	*	5/2012	Joseph	D2/970
D690,495	S	*	10/2013	Bosomworth	D2/972
D707,942	S	*	7/2014	Portzline	D2/969
8,806,776	B2	*	8/2014	Leick A43B 23/0275 36/50.1	
D722,429	S	*	2/2015	Amphyon	D2/972
D725,363	S	*	3/2015	Fuhrer	D2/972
D725,364	S	*	3/2015	Fuhrer	D2/972
D725,889	S	*	4/2015	Amphyon	D2/972
D725,890	S	*	4/2015	Bosomworth	D2/972

D731,773	S	*	6/2015	Bosomworth	D2/972
D731,777	S	*	6/2015	Grenet	D2/972
D737,036	S	*	8/2015	Bosomworth	D2/972
D746,036	S	*	12/2015	Harlow	D2/972
D753,382	S	*	4/2016	Lamont	D2/972
D753,383	S	*	4/2016	Nikolic	D2/972
D794,940	S	*	8/2017	Fudalik	D2/973
D816,318	S	*	5/2018	Cooper	D2/973
D818,673	S	*	5/2018	Bacon	D2/902
D826,539	S	*	8/2018	McCourt	D2/972
D835,392	S	*	12/2018	Durfinger	D2/972
D838,457	S	*	1/2019	Ledbetter	D2/970
D846,857	S	*	4/2019	Bacon	D2/969
D878,029	S	*	3/2020	Young	D2/972
D899,037	S	*	10/2020	Van De Stouwe	D2/907
D905,937	S	*	12/2020	Lee	D2/907

OTHER PUBLICATIONS

Kiara Pro Sneaker, VionicShoes.com, [online], [site visited Aug. 30, 2021], <URL: <https://www.vionicshoes.com/kiara-pro-sneaker.html?76=401>> (Year: 2021).*

Avia Men's Wide Width Slip-On Walking Shoe, Walmart.com, [online], [site visited Aug. 30, 2021], <URL: <https://www.walmart.com/ip/Avia-Men-s-Wide-Width-Slip-On-Walking-Shoe/794193802>> (Year: 2021).*

* cited by examiner

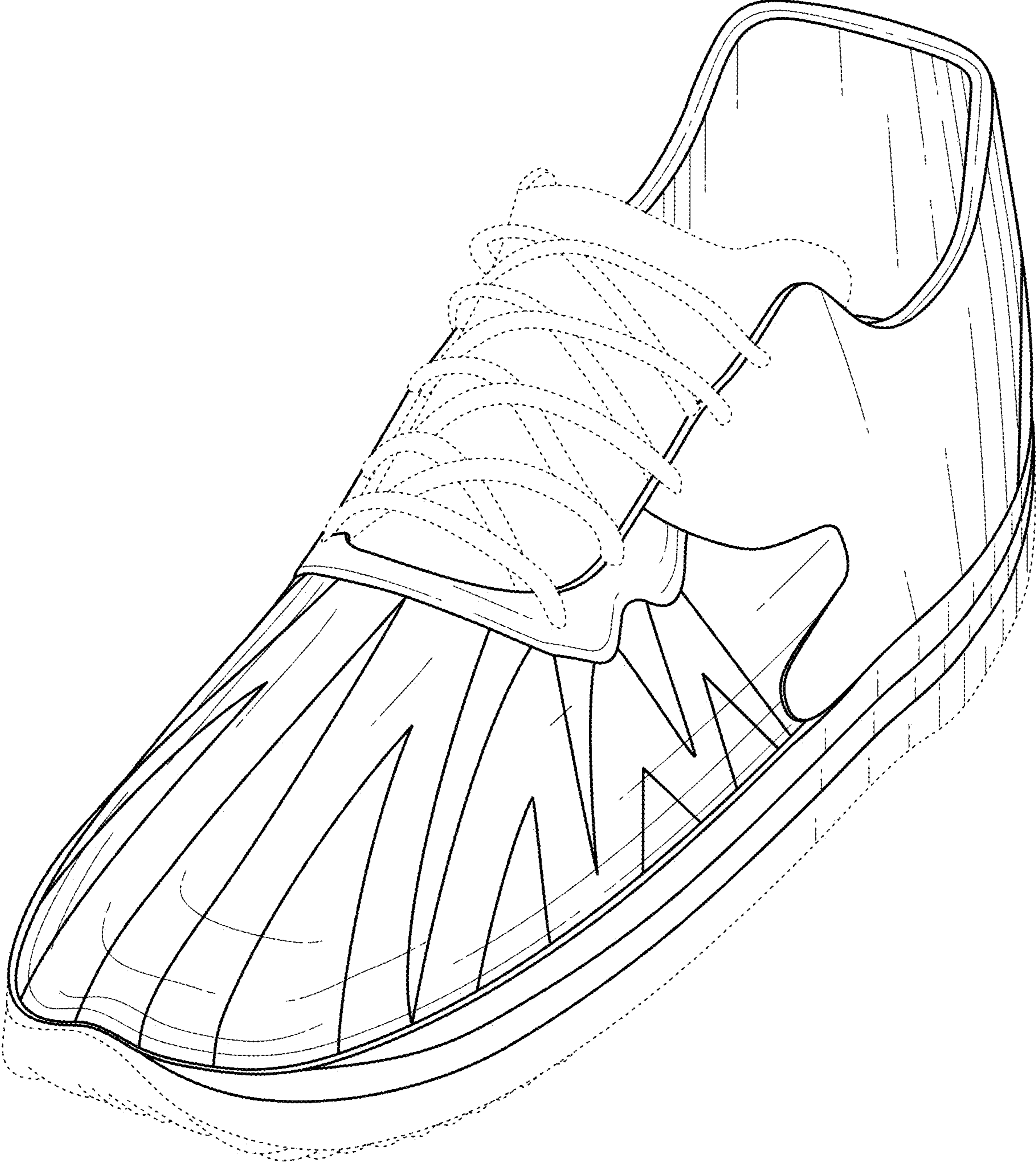

FIG. 1

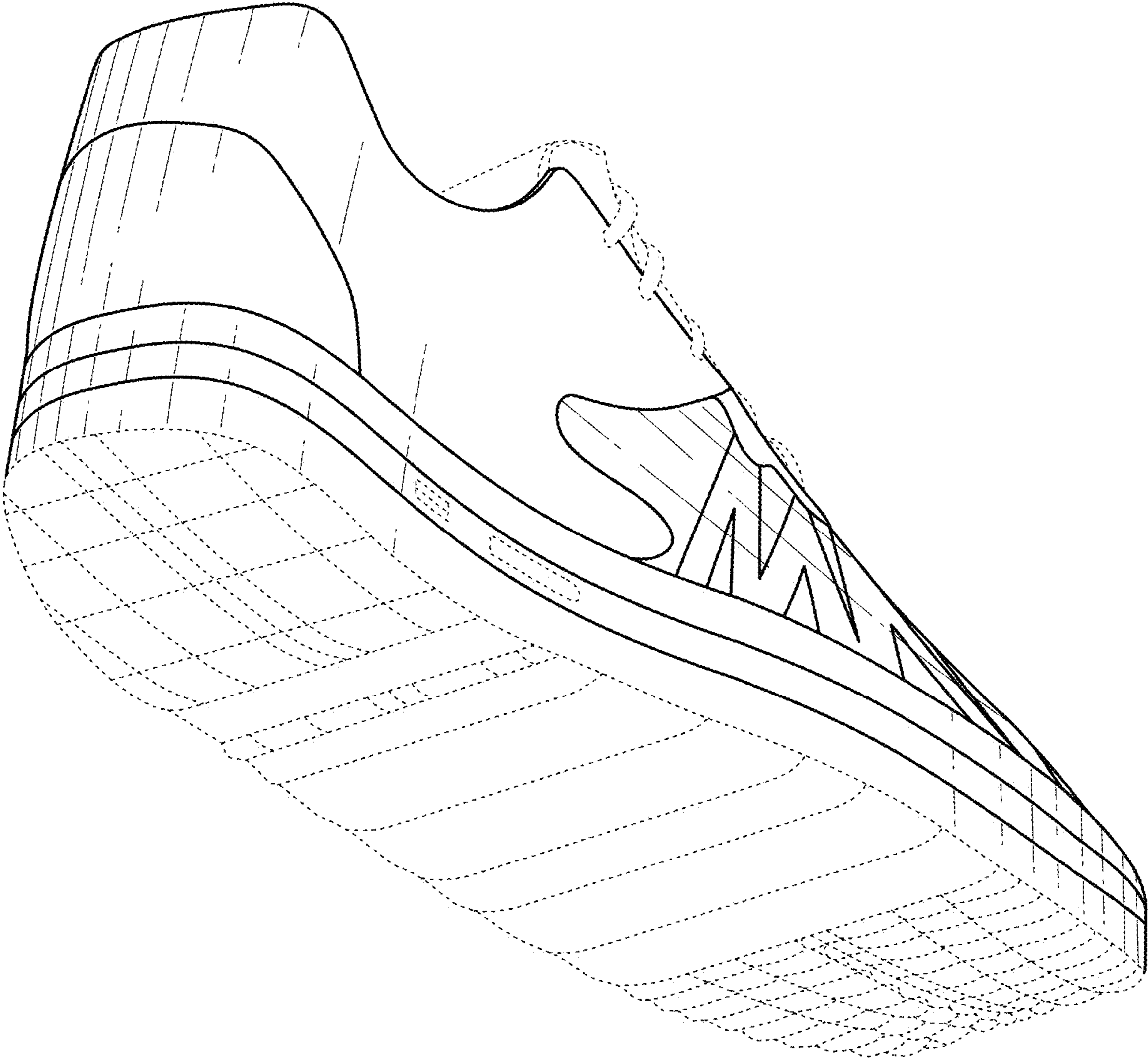

FIG. 2

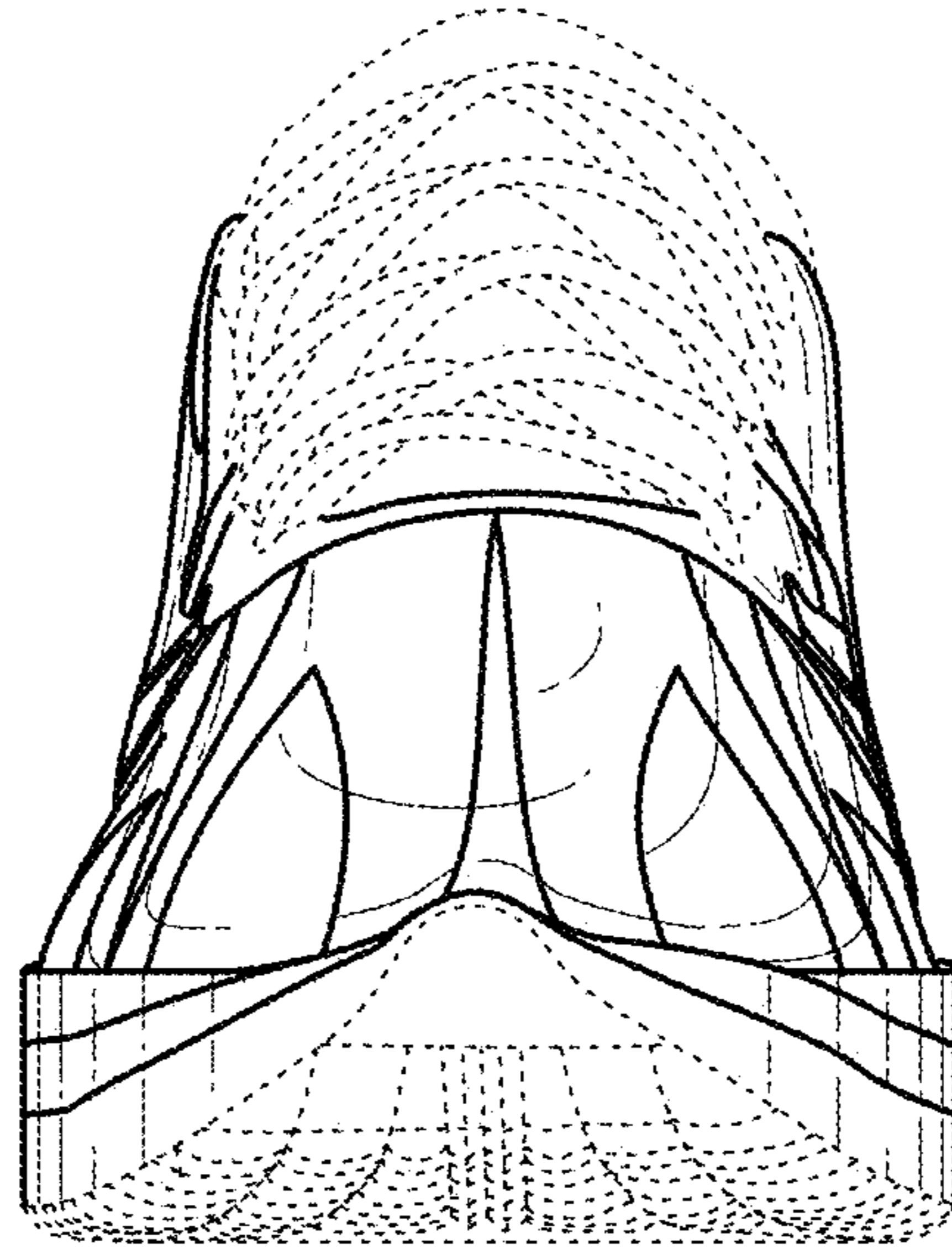

FIG. 3

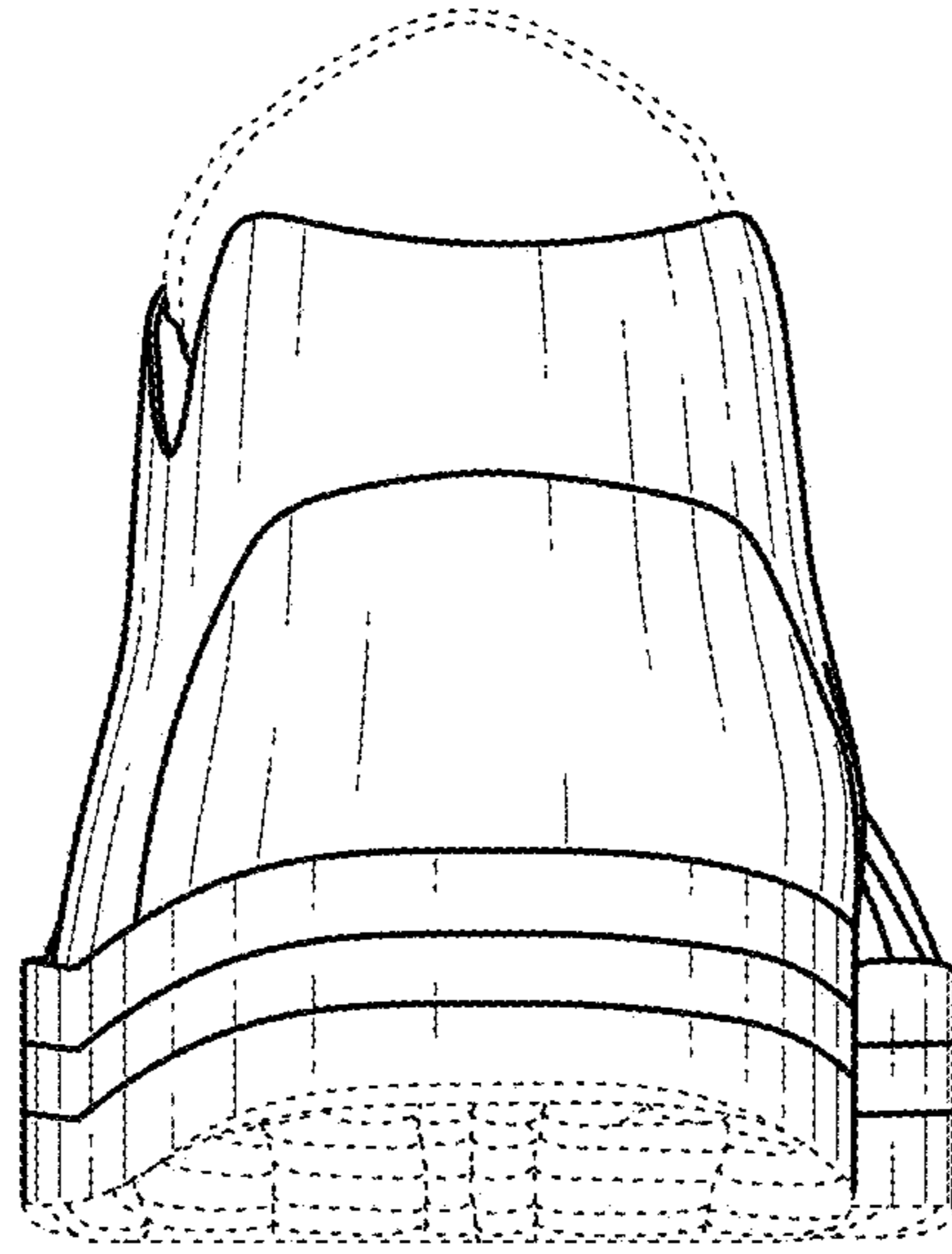

FIG. 4

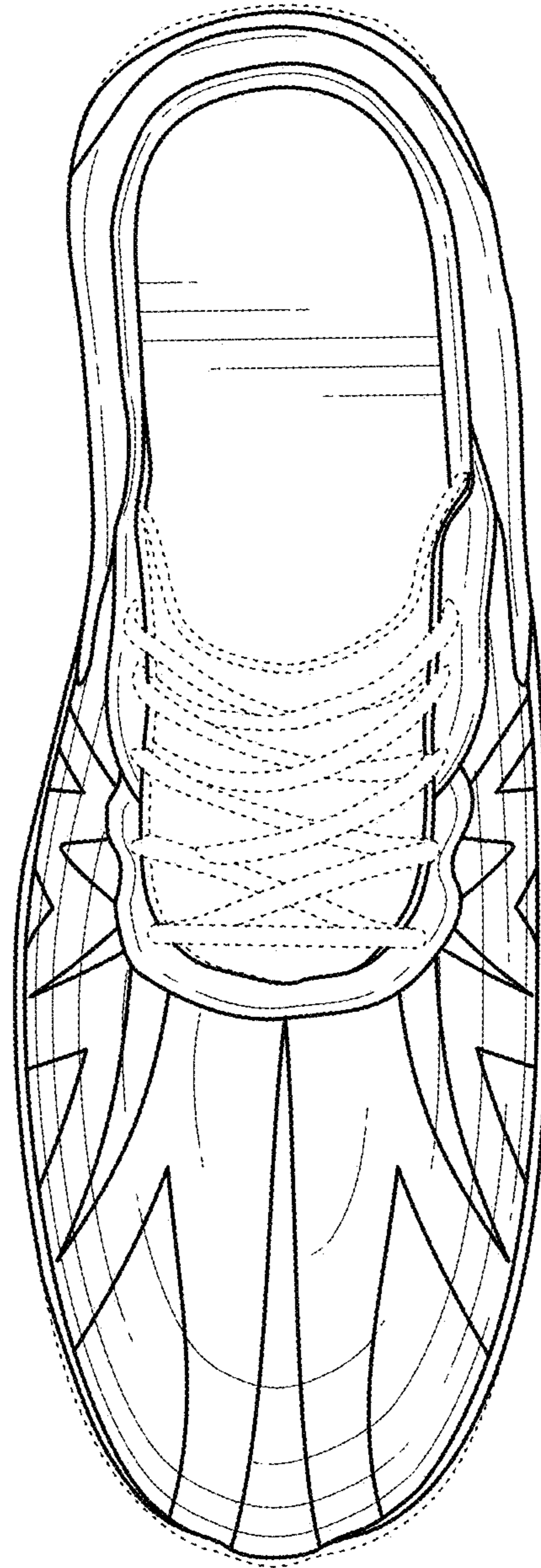

FIG. 5

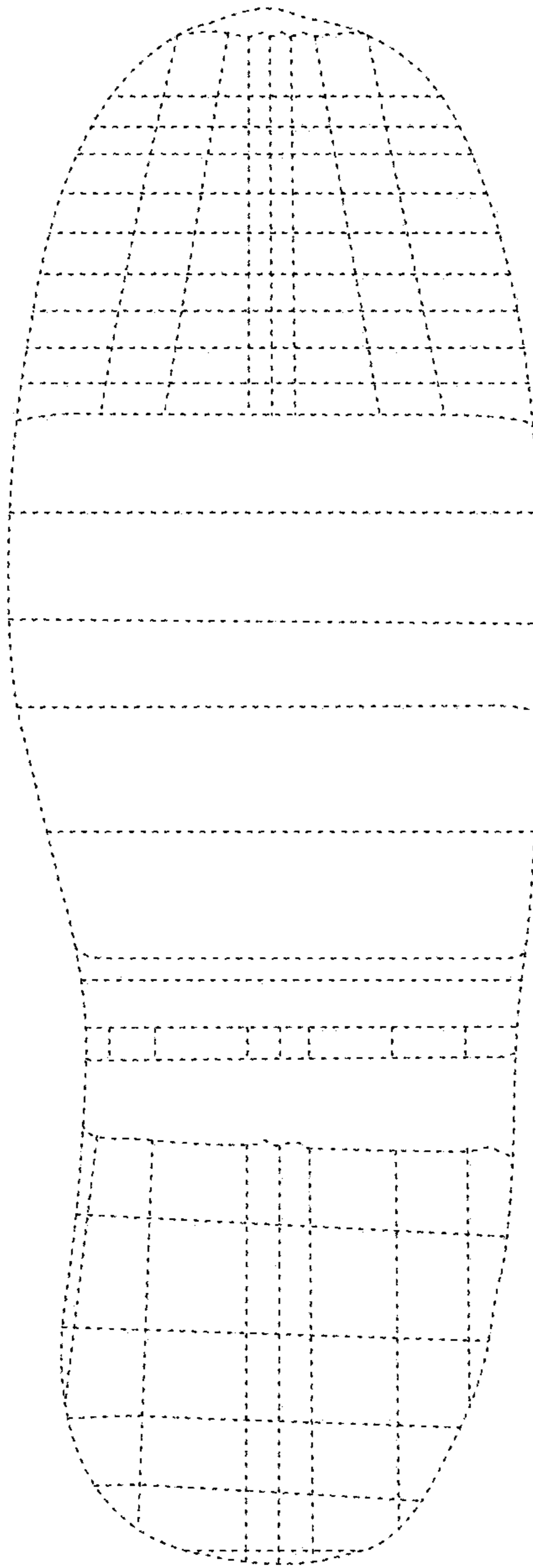

FIG. 6

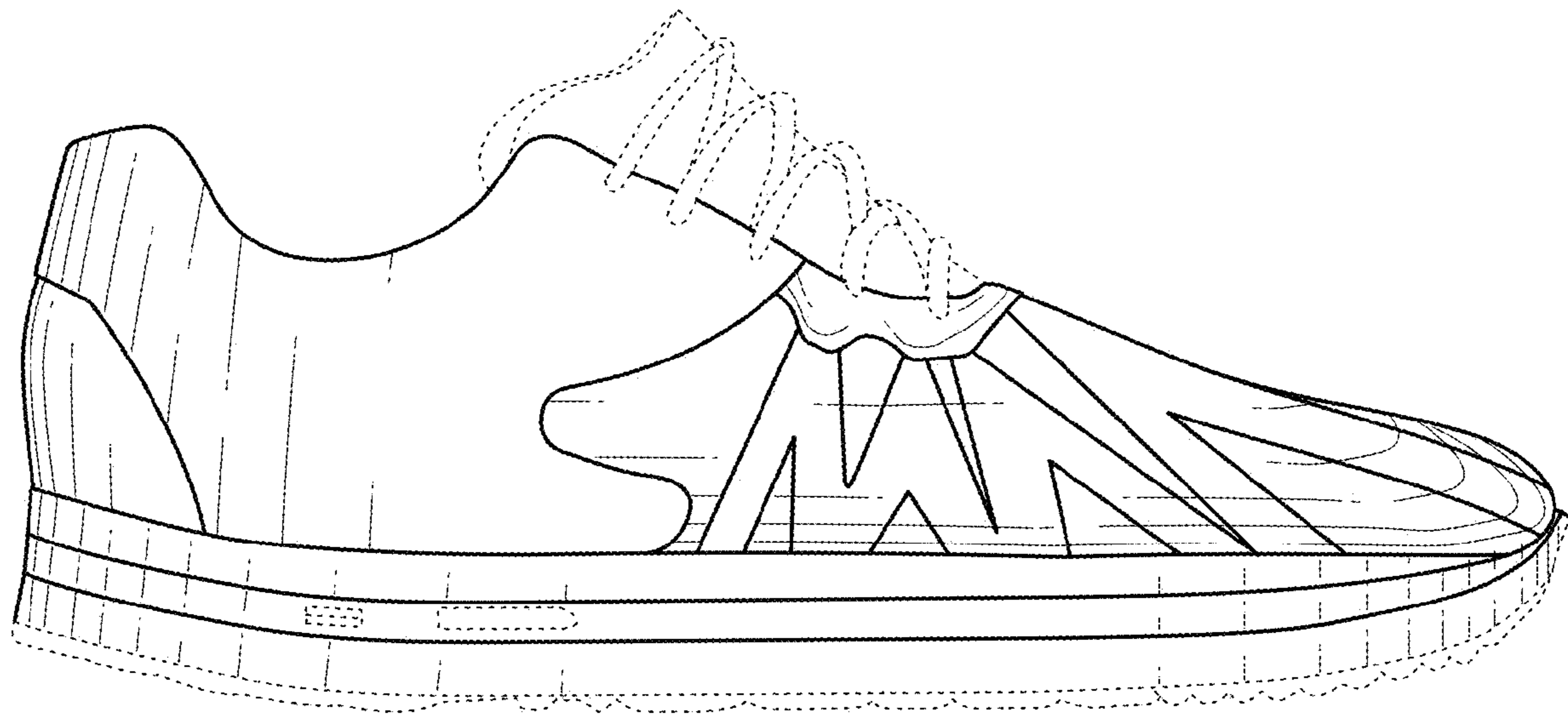

FIG. 7

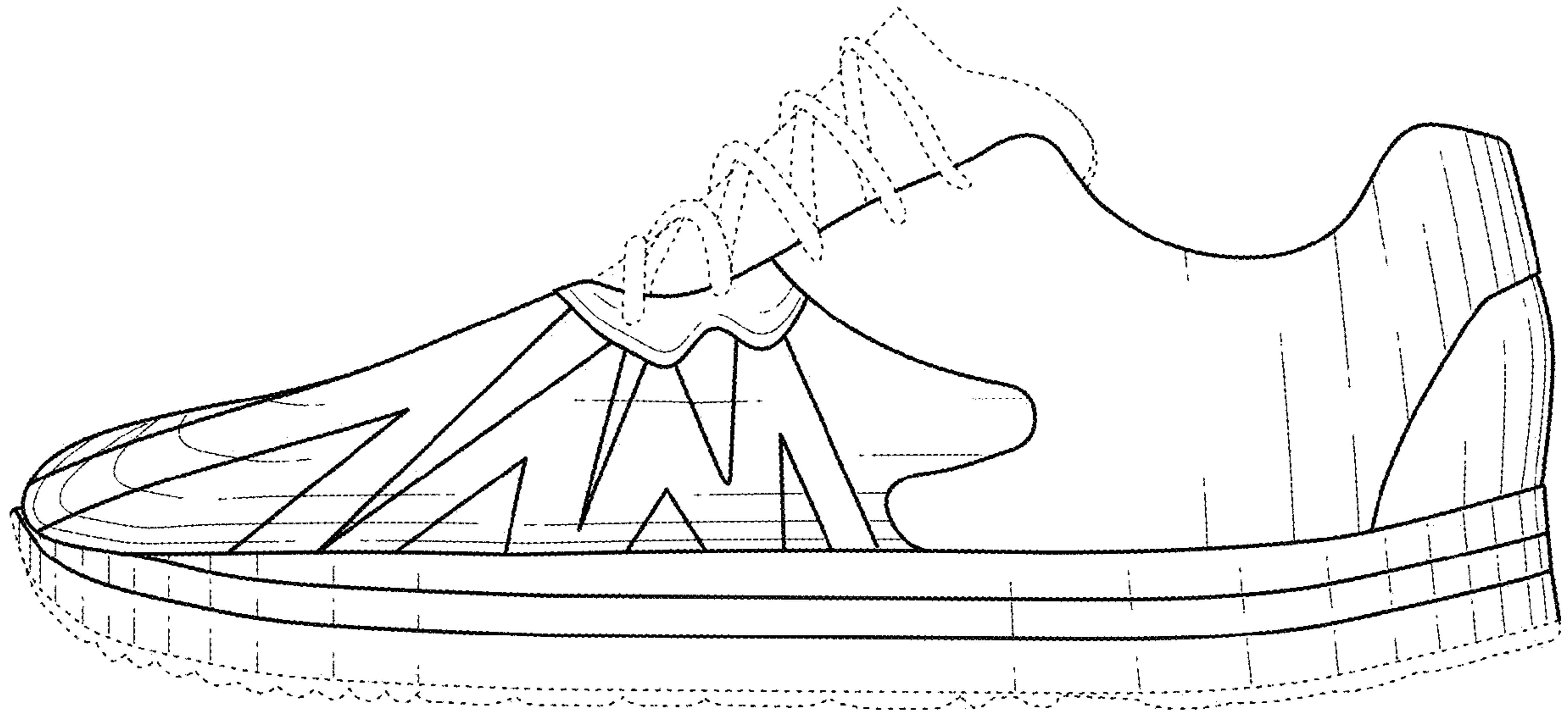

FIG. 8