



US00D945673S

(12) **United States Design Patent**
Mullen

(10) **Patent No.:** **US D945,673 S**
(45) **Date of Patent:** **** Mar. 8, 2022**

- (54) **TIKI TORCH LIGHT FIXTURE**
- (71) Applicant: **Nate Mullen**, Valley Center, CA (US)
- (72) Inventor: **Nate Mullen**, Valley Center, CA (US)
- (**) Term: **15 Years**
- (21) Appl. No.: **29/713,453**
- (22) Filed: **Nov. 15, 2019**
- (51) **LOC (13) Cl.** **26-05**
- (52) **U.S. Cl.**
USPC **D26/67**
- (58) **Field of Classification Search**
USPC D10/111–115; D26/24, 26, 34, 44, 51,
D26/58, 60, 61, 63, 67, 68, 71, 72, 74,
D26/75, 76, 78, 80–89, 92, 93, 102, 104,
D26/106, 108, 110, 113, 117, 118, 119,
D26/121, 135, 141, 142, 148
CPC F21S 8/00; F21S 8/02; F21S 8/03; F21S
8/033; F21S 8/032; F21S 8/036; F21S
8/04; F21S 8/043; F21S 8/08; F21S
8/081; F21S 8/086; F21S 8/088; F21S
8/06; F21S 8/061; F21S 8/063; F21S
8/065; F21S 10/005; F21S 6/002; F21S
6/005; F21S 6/006
See application file for complete search history.

- D880,757 S * 4/2020 Laviani D26/93
- D900,378 S * 10/2020 Peng D26/108
- D927,047 S * 8/2021 Mullen D26/118

OTHER PUBLICATIONS

Polynesian—Tiki Light _ Lifetime Lighting Systems (available online) Retrieved from the internet Sep. 24, 2021 from URL: <https://lifetimelightingsystems.com/landscape-lighting/polynesian/>.*

Hinkley Hardy Island (available online) Retrieved from the internet Sep. 24, 2021 from URL: https://www.lampsplus.com/products/hinkley-hardy-island-15-and-one-half-inch-high-matte-bronze-path-light_65a83.html.*

(Continued)

Primary Examiner — Richard Kearney
(74) *Attorney, Agent, or Firm* — Kelly & Kelley, LLP

(57) **CLAIM**

The ornamental design for a tiki torch light fixture, as shown and described.

DESCRIPTION

FIG. 1 is a perspective view of a tiki torch light fixture of the present invention;
 FIG. 2 is a front view of the tiki torch light fixture of the present invention;
 FIG. 3 is a back view of the tiki torch light fixture of the present invention;
 FIG. 4 is a right side view of the tiki torch light fixture of the present invention;
 FIG. 5 is a left side view of the tiki torch light fixture of the present invention;
 FIG. 6 is a top view of the tiki torch light fixture of the present invention; and,
 FIG. 7 is a bottom view of the tiki torch light fixture of the present invention.

The broken lines shown in the drawings illustrate environmental subject matter and form no part of the claimed design.

1 Claim, 7 Drawing Sheets

(56) **References Cited**

U.S. PATENT DOCUMENTS

- 130,899 A * 8/1872 Combs F21V 1/24
362/361
- D85,323 S * 10/1931 Carder D26/104
- D202,804 S * 11/1965 Bushcott D26/135
- D204,079 S * 3/1966 Bushcott D26/135
- D385,647 S * 10/1997 Swanson D26/110
- D505,213 S * 5/2005 Kumar D26/9
- D562,488 S * 2/2008 Weiser D26/67
- D715,986 S * 10/2014 Anastasiades D26/88
- D790,109 S * 6/2017 Starck D26/110
- D868,344 S * 11/2019 Sonneman D26/118

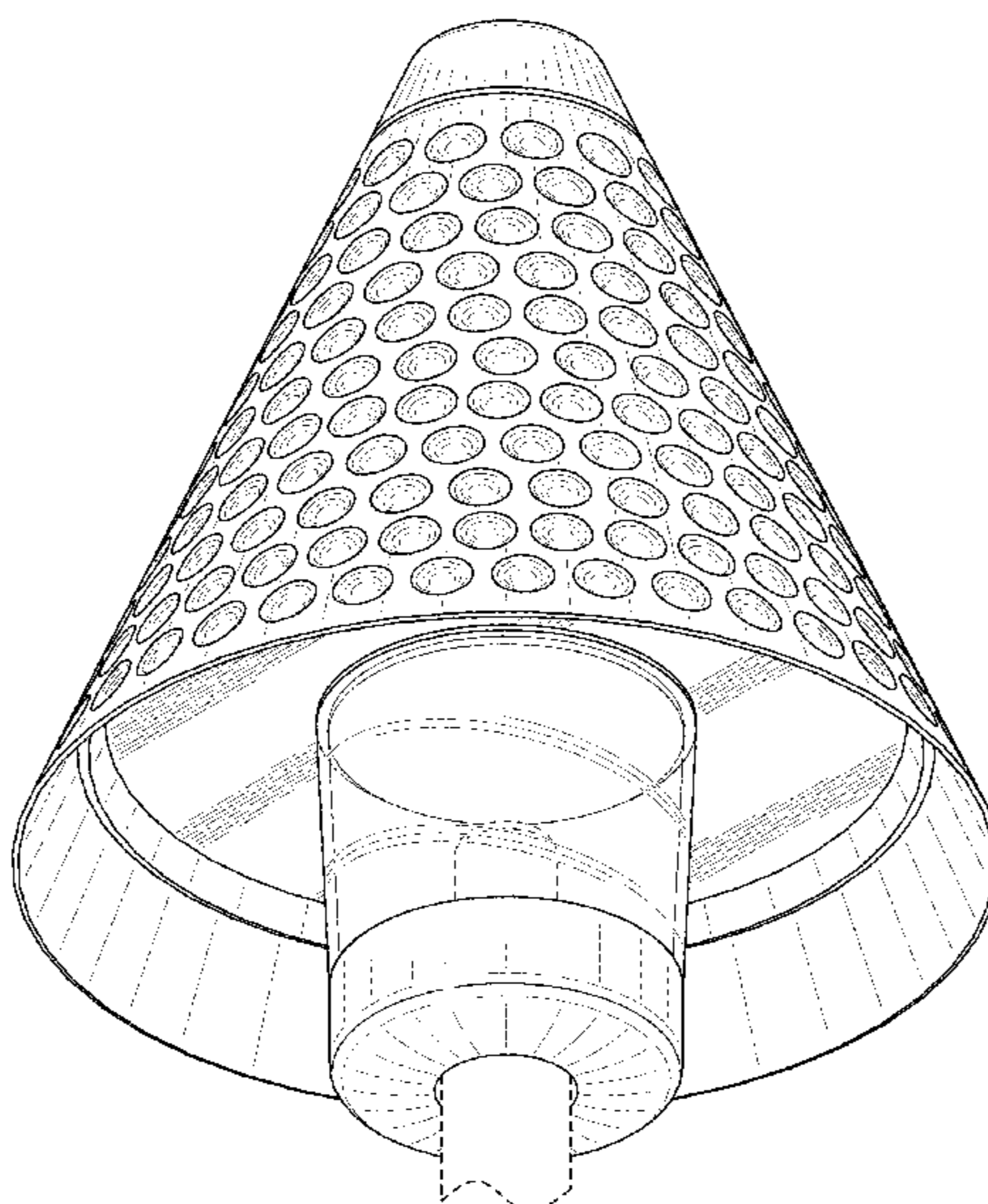

(56)

References Cited

OTHER PUBLICATIONS

Cosmo Dimple Table Lamp (available online) Retrieved from the internet Sep. 24, 2021 from URL: https://www.lightology.com/index.php?module=prod_detail&prod_id=888901&cat_id=40.*

LED Aluminum Pathlight (available online) Retrieved from the internet Sep. 24, 2021 from URL: <https://www.litethenite.com/ap136tbz>.*

* cited by examiner

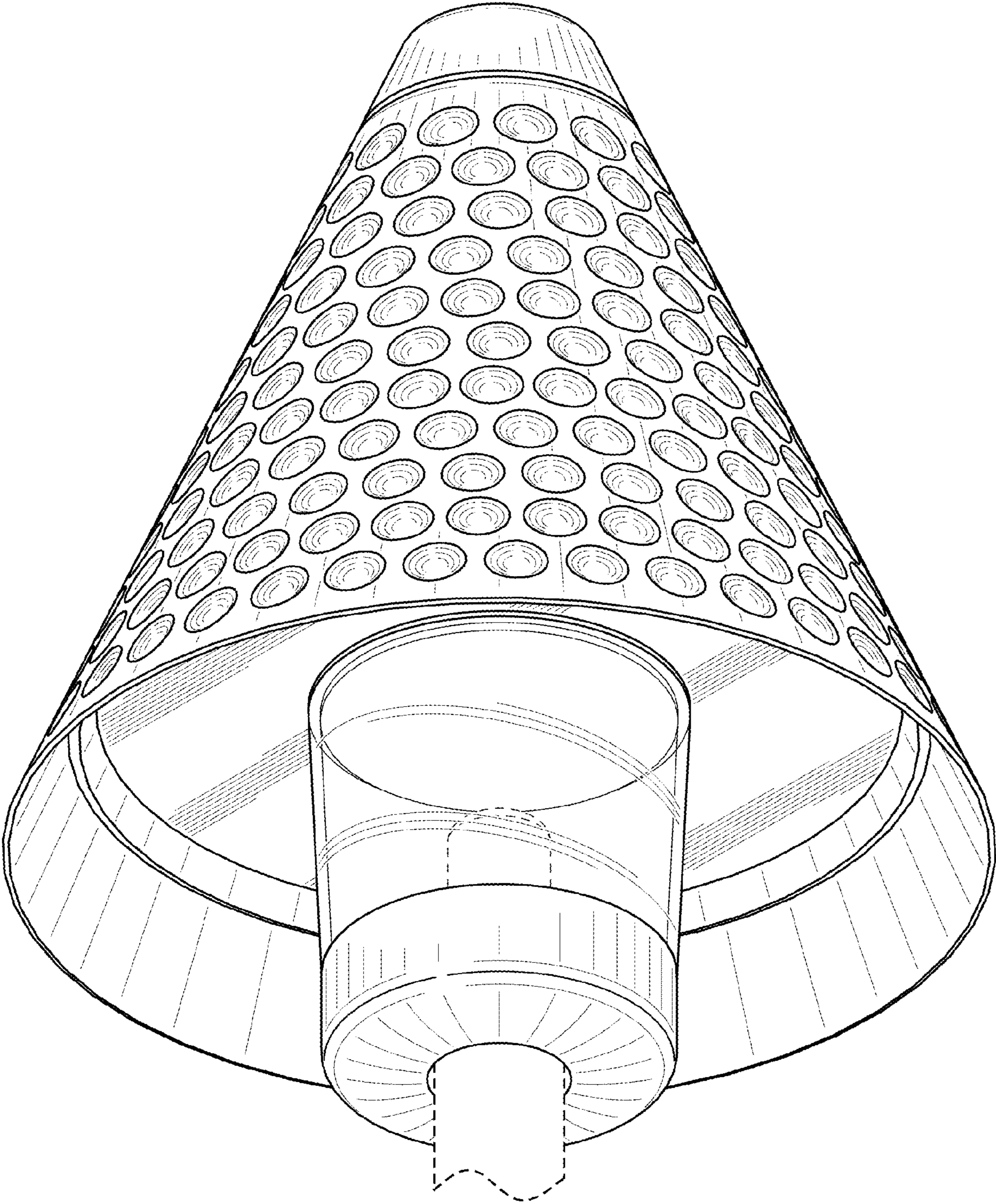

FIG. 1

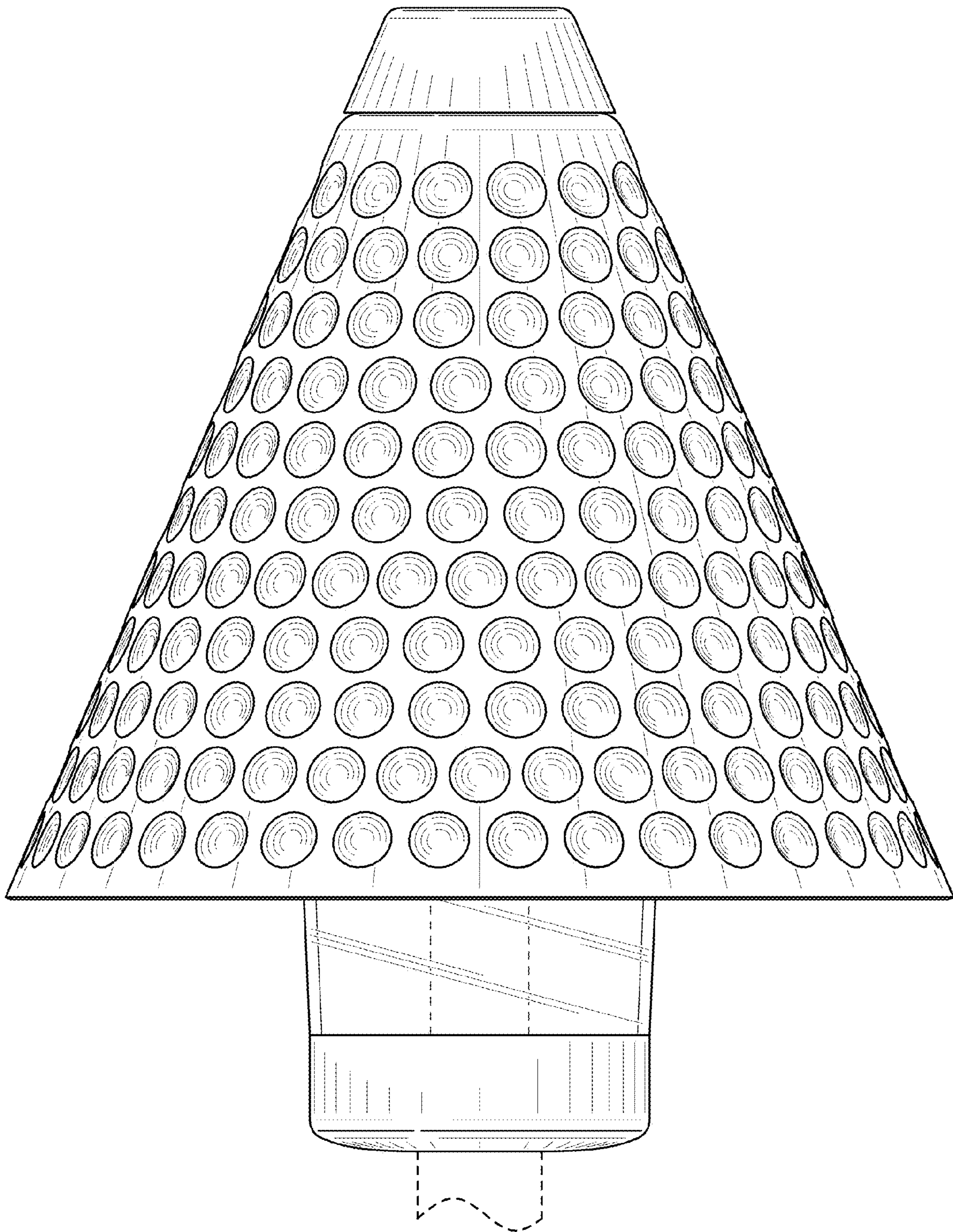

FIG. 2

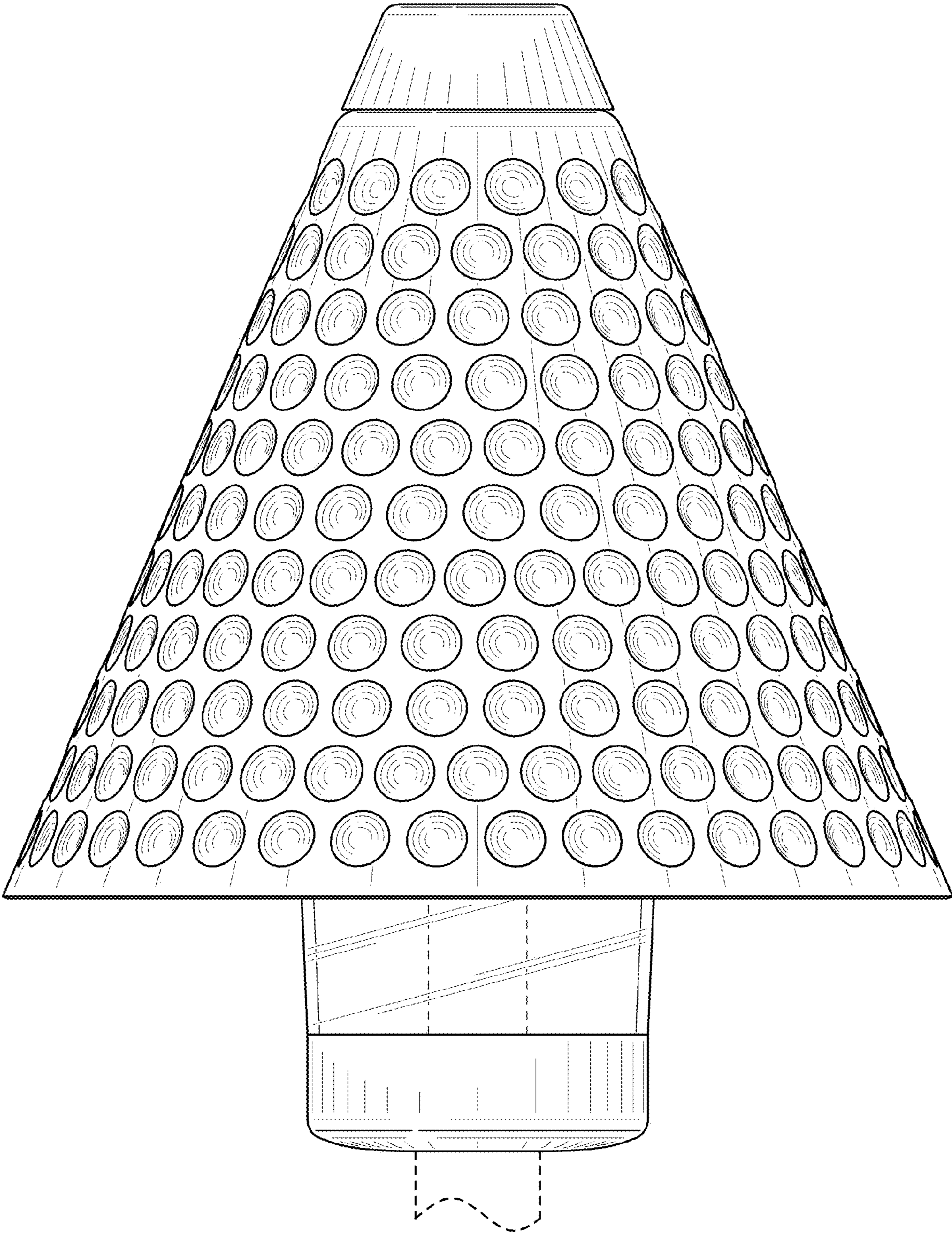

FIG. 3

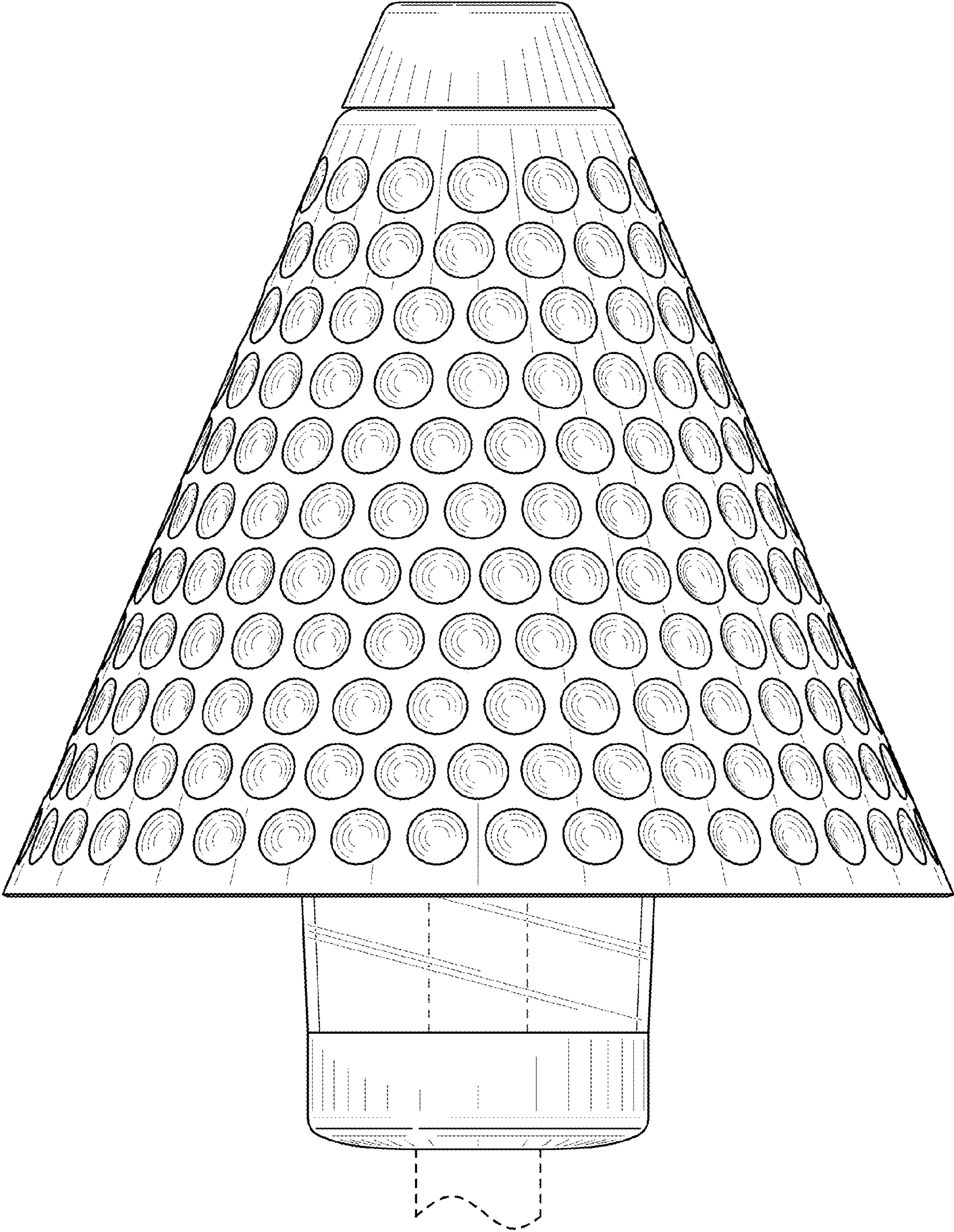

FIG. 4

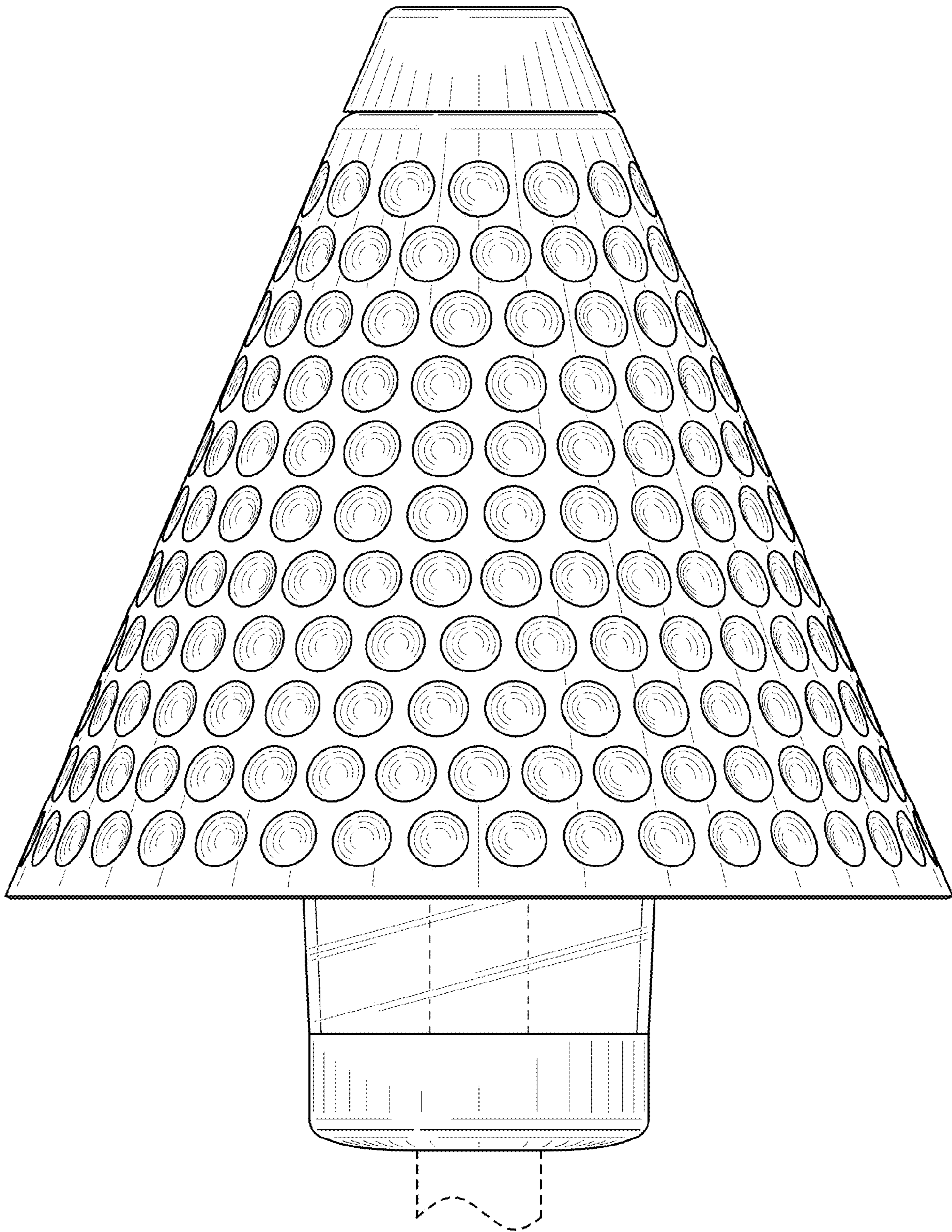

FIG. 5

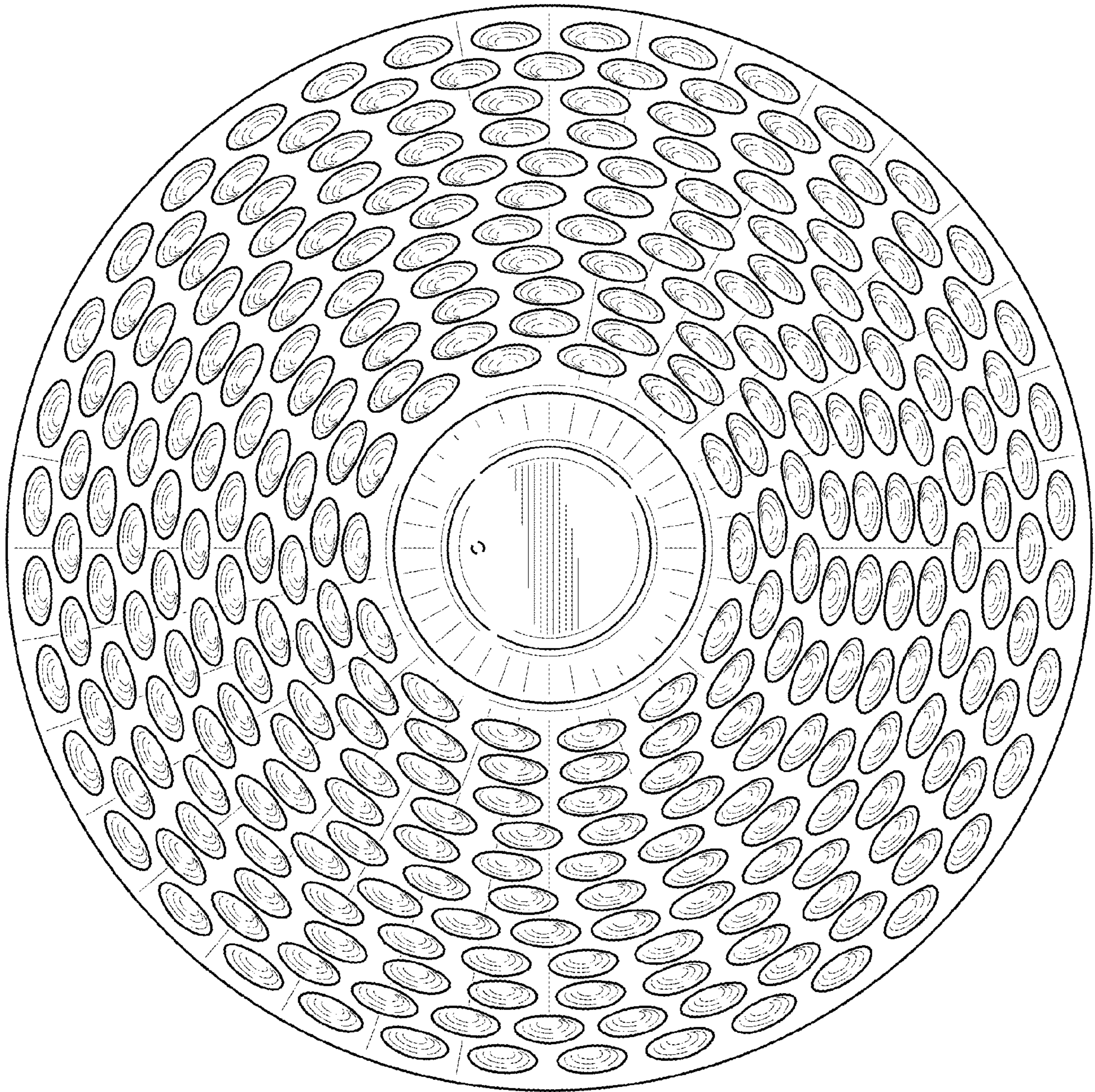

FIG. 6

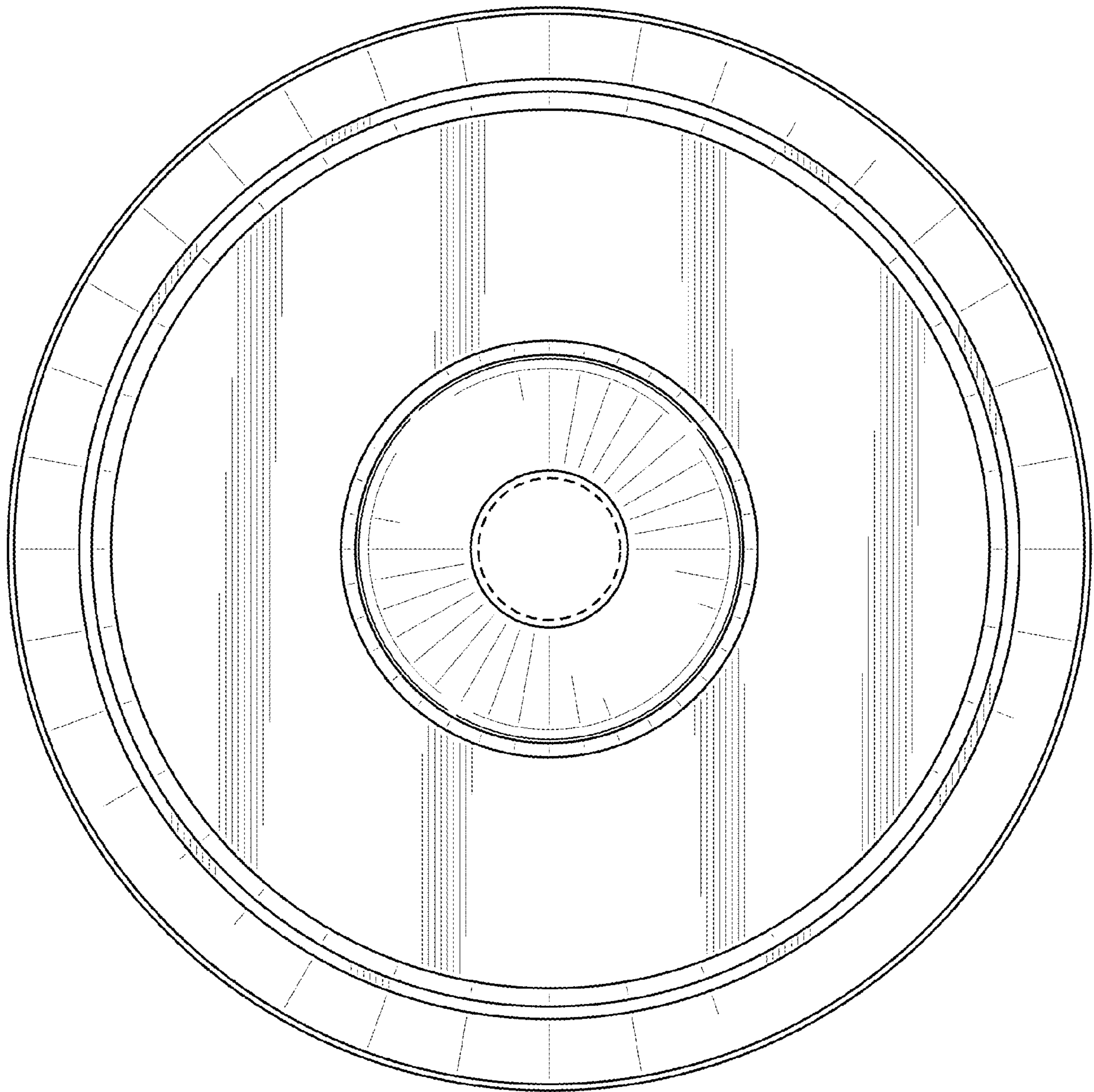

FIG. 7