



US00D945604S

(12) **United States Design Patent** (10) **Patent No.:** **US D945,604 S**
Scott (45) **Date of Patent:** **** Mar. 8, 2022**

(54) **TRAVEL CATHETER BAG**

FOREIGN PATENT DOCUMENTS

(71) Applicant: **Melchizedek Dontell Scott,**
McDonough, GA (US)

CN 304271646 * 9/2017
JP D1290887 * 1/2007

(72) Inventor: **Melchizedek Dontell Scott,**
McDonough, GA (US)

OTHER PUBLICATIONS

(**) Term: **15 Years**

[Wide Mouth Cantene], Amazon.com, Date First Available: Dec. 22, 2008 [online], Customer Review Oldest Date: Aug. 24, 2010 [online], site visited: [Oct. 22, 2021], URL: <https://www.amazon.com/Nalgene-Wide-Mouth-Cantene-48-Ounce/dp/B000BS0AQU/>. (Year: 2008).*

(21) Appl. No.: **29/729,264**

(Continued)

(22) Filed: **Mar. 25, 2020**

(51) **LOC (13) Cl.** **24-02**

Primary Examiner — T Chase Nelson

(52) **U.S. Cl.**

Assistant Examiner — Amanda J Berlinski

USPC **D24/122**; D24/118

(74) *Attorney, Agent, or Firm* — Dunlap Bennett & Ludwig, PLLC; Anna L. Kinney

(58) **Field of Classification Search**

USPC D24/108, 117, 118, 121, 122, 123, 127, D24/128, 206, 207, 224; D9/708, 709; D23/200, 302, 303, 309, 295, 274; 600/573, 574; 604/329, 322, 317, 318, 604/334, 323, 327, 355; 141/372; 4/144.1, 144.2, 144.3, 144.4, 445, 459, 4/460

(57) **CLAIM**

The ornamental design for a travel catheter bag, as shown and described.

CPC A61M 1/0019; A61M 1/0088; A61M 2202/0496; A61M 2205/273; A61J 1/10; A61J 1/1412

DESCRIPTION

See application file for complete search history.

FIG. 1 is a top front perspective view of a travel catheter bag showing my new design, illustrated in an open position; FIG. 2 is a front elevational view thereof; FIG. 3 is a rear elevational view thereof; FIG. 4 is a right elevational view thereof; FIG. 5 is a left elevational view thereof; FIG. 6 is a top plan view thereof; FIG. 7 is a bottom view thereof; FIG. 8 is a top front perspective view of the catheter bag of FIG. 1 illustrated in a stored position; FIG. 9 is a front elevational view thereof; FIG. 10 is a rear elevational view thereof; FIG. 11 is a right elevational view thereof; FIG. 12 is a left elevational view thereof; FIG. 13 is a top plan view thereof; and, FIG. 14 is a bottom view thereof.

(56) **References Cited**

U.S. PATENT DOCUMENTS

D47,763 S * 8/1915 Stauffer D24/207
D150,125 S * 7/1948 Gardner D24/207
2,819,791 A * 1/1958 Coburn B65D 75/38
206/364
3,099,308 A * 7/1963 Rusch A61F 7/08
383/109
D196,612 S * 10/1963 Alder et al. D24/118
D227,184 S * 6/1973 Stevens et al. D24/118
D232,157 S * 7/1974 Jacobs D24/117

(Continued)

1 Claim, 4 Drawing Sheets

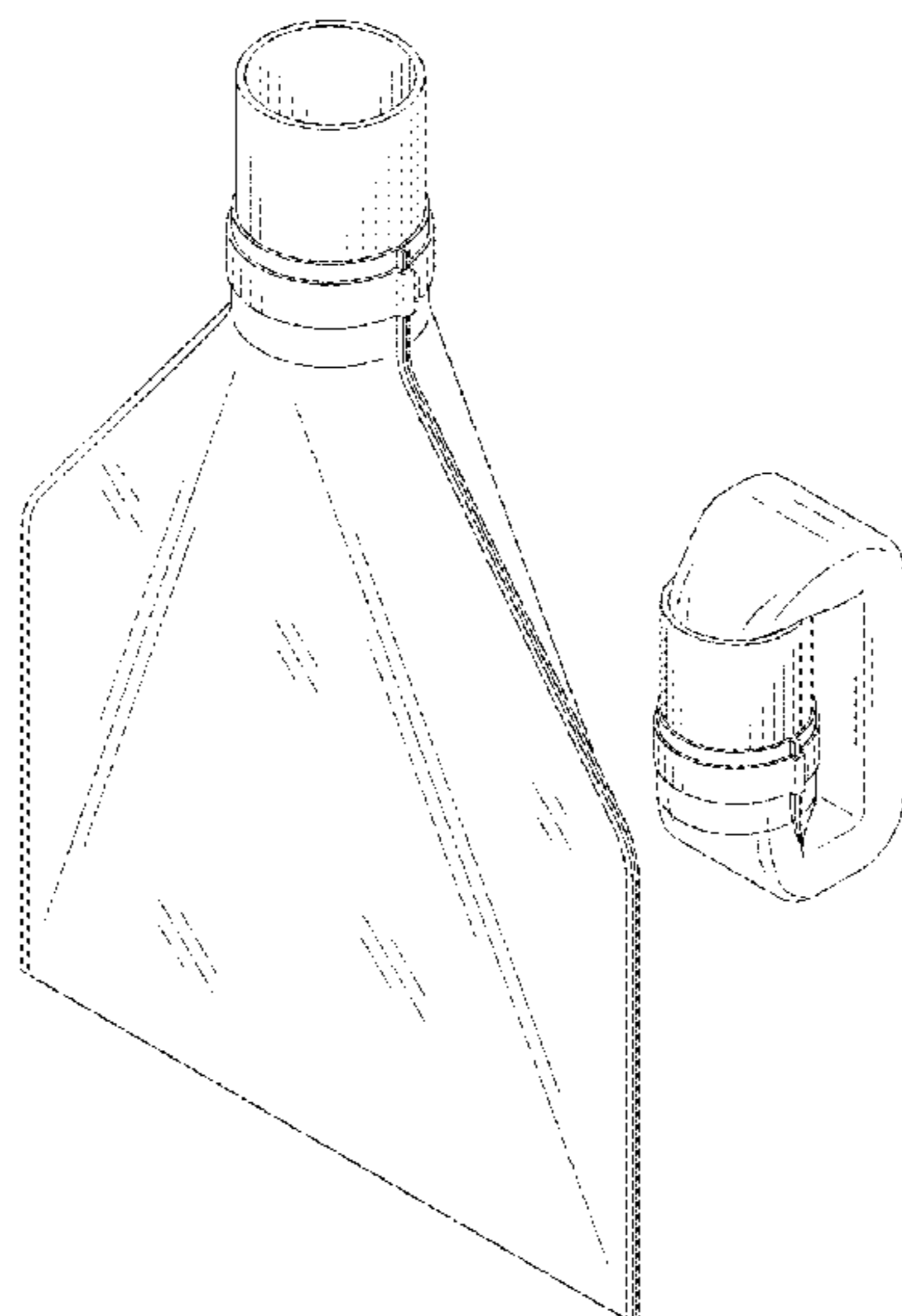

(56)

References Cited

U.S. PATENT DOCUMENTS

D233,314 S * 10/1974 Turner et al. D24/115
 D242,958 S * 1/1977 Manschot D24/118
 D243,121 S * 1/1977 Ralston, Jr. et al.
 D255,492 S * 6/1980 Meierhoefer D24/117
 D265,760 S * 8/1982 Lahay D24/117
 D303,714 S * 9/1989 Manschot
 D336,034 S * 6/1993 Rebilas D24/118
 D366,142 S * 1/1996 Becker
 D379,520 S * 5/1997 Stevens D24/224
 D400,251 S * 10/1998 Ropiak D24/118
 6,196,979 B1 * 3/2001 Virtanen G01N 33/54373
 600/573
 D476,079 S * 6/2003 Kubalak et al.
 D619,906 S * 7/2010 Carignan D9/708
 D662,202 S * 6/2012 O'Donnell D24/118
 D664,863 S * 8/2012 Kristoff D9/709
 D686,088 S * 7/2013 Murray
 D700,067 S * 2/2014 Murray
 D777,043 S * 1/2017 Temple
 9,598,209 B1 * 3/2017 Maldonado B65D 75/5883
 D785,164 S * 4/2017 Subramanian
 D785,165 S * 4/2017 Nordquist D24/118
 D803,388 S * 11/2017 Miller D24/108
 D817,484 S * 5/2018 Lafond
 D820,686 S * 6/2018 Francis D9/709
 D827,129 S * 8/2018 Lafond D24/118
 D867,161 S * 11/2019 Clearman et al.
 D910,838 S * 2/2021 Zhang D24/118
 D920,129 S * 5/2021 Gosling D9/708
 D922,881 S * 6/2021 Haskins D9/708
 D927,683 S * 8/2021 Blin D24/118

2005/0136535 A1* 6/2005 Malinge C12M 23/08
 435/304.2
 2005/0239196 A1* 10/2005 Yanai C12M 23/26
 435/289.1
 2021/0299337 A1* 9/2021 Scott A61M 1/90

OTHER PUBLICATIONS

[Rusch—Teleflex B1000 Belly Bag Urine Bag, Bellybag Drnbag 1000cc], Amazon.com, Date First Available: Feb. 27, 2010 [online], Customer Review Oldest Date: Jun. 9, 2014 [online], site visited: [Oct. 22, 2021], URL: <<https://www.amazon.com/Rusch-Teleflex-Bellybag-Drnbag-1000cc/dp/B007AZ4CQ6>>. (Year: 2010).*

[SOURCE Liquitainer Flexible Water Bottle], YouTube.com, Posted May 4, 2011 [online], site visited: [Oct. 22, 2021], URL: <<https://www.youtube.com/watch?v=dnN9KD6HDMg>>. (Year: 2011).*

[Platypus Ultralight Collapsible SoftBottle with Push-Pull Cap], Amazon.com, Date First Available: Aug. 8, 2012 [online], Customer Review Oldest Date: Dec. 29, 2012 [online], site visited: [Oct. 22, 2021], URL: <<https://www.amazon.com/Platypus-Soft-Bottle-Push-Pull-1-Liter/dp/B008W0IAOS/>>. (Year: 2012).*

[YYAN Portable Female Male Urinal Bag, Women Man Urination Device, Woman Standing up Pee Funnel, Silicone Reusable Collapsible Urine Cup, for Car Outdoor Camping Travel Backpacking], Amazon.com, Date First Available: Oct. 13, 2019 [online], Customer Review Oldest Date: Feb. 21, 2020 [online], site visited: [Oct. 22, 2021], URL: <<https://www.amazon.com/dp/B07Z2PKK9H/>>. (Year: 2019).*

[Urine Collecting Bag With Measured Volume chamber U-2015 Uro-Count], available on mediplusindia.com, announced Year 2021 [online], [site visited Oct. 22, 2021], Internet URL: <<https://www.mediplusindia.com/products/urine-collecting-bag-with-measured-volume-chamber/>>. (Year: 2021).*

* cited by examiner

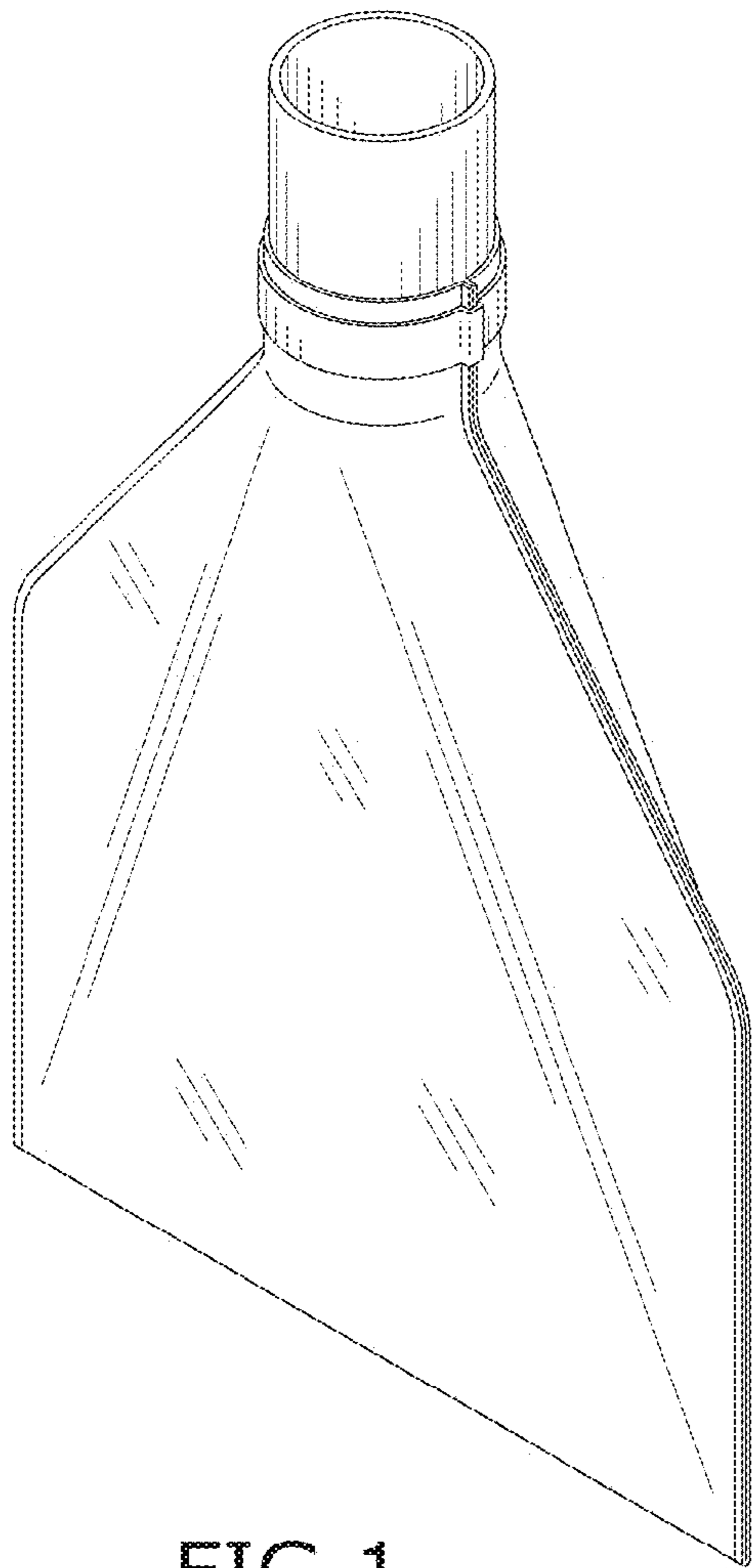

FIG. 1

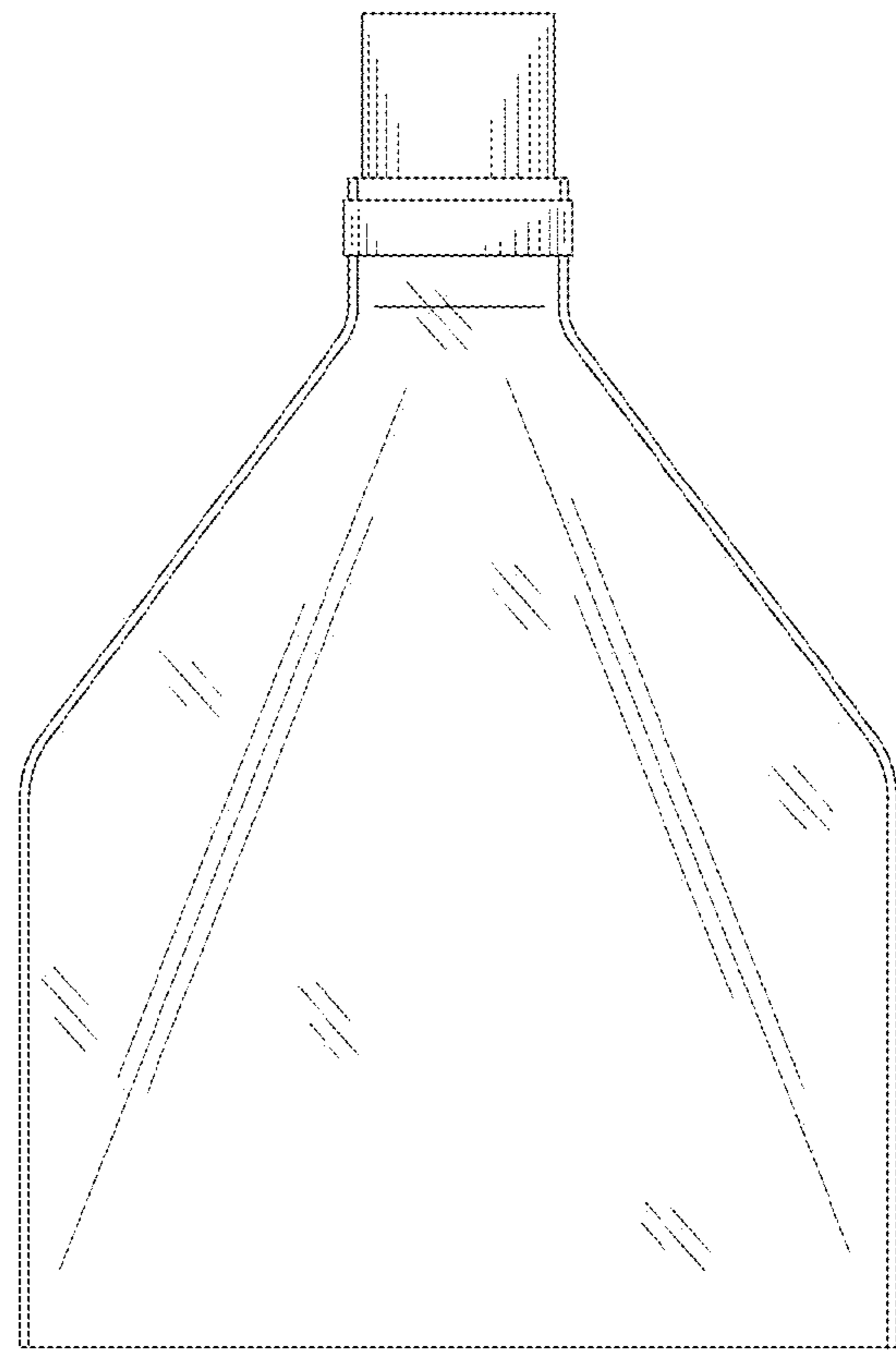

FIG. 2

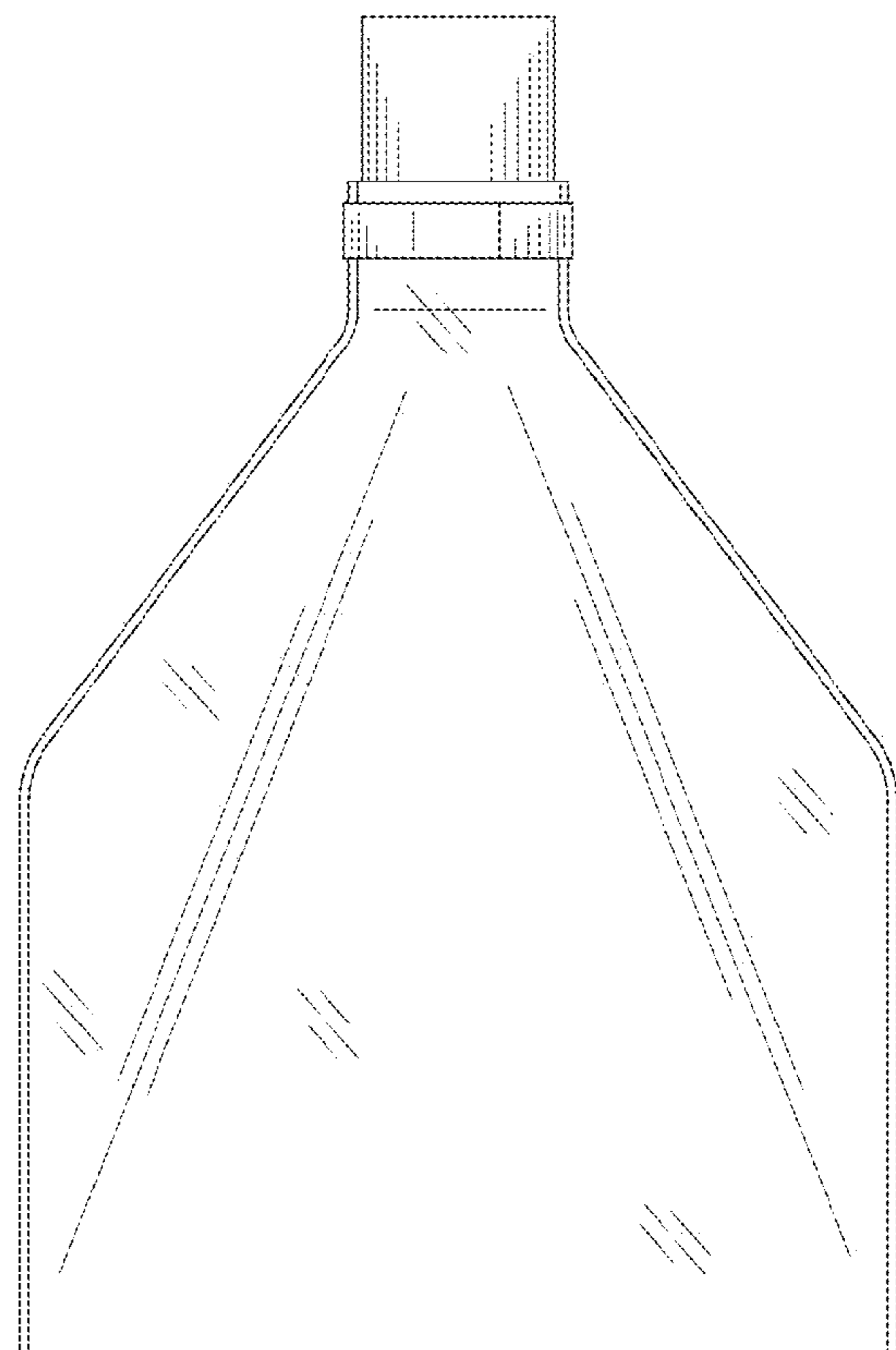

FIG. 3

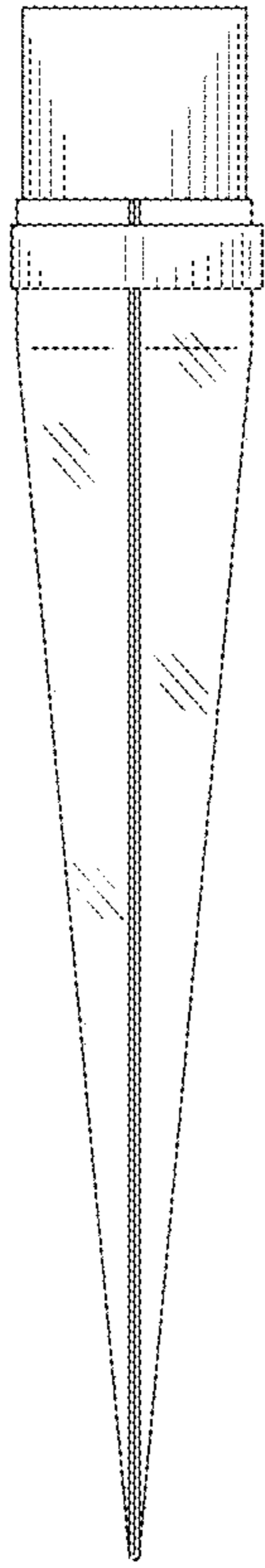

FIG. 4

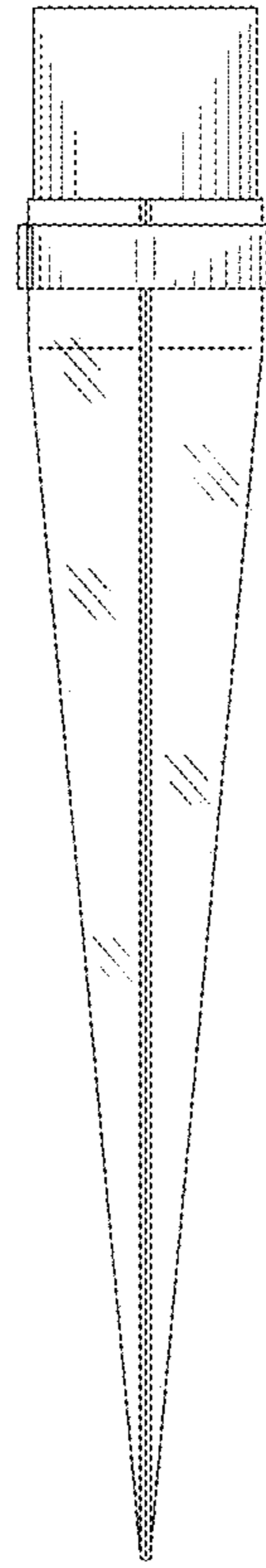

FIG. 5

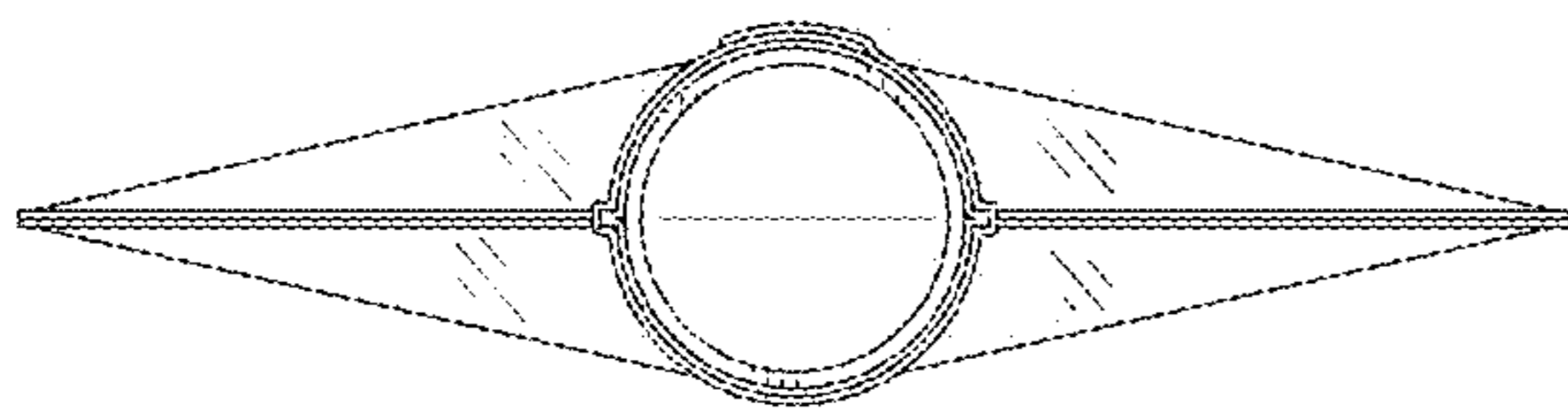

FIG. 6

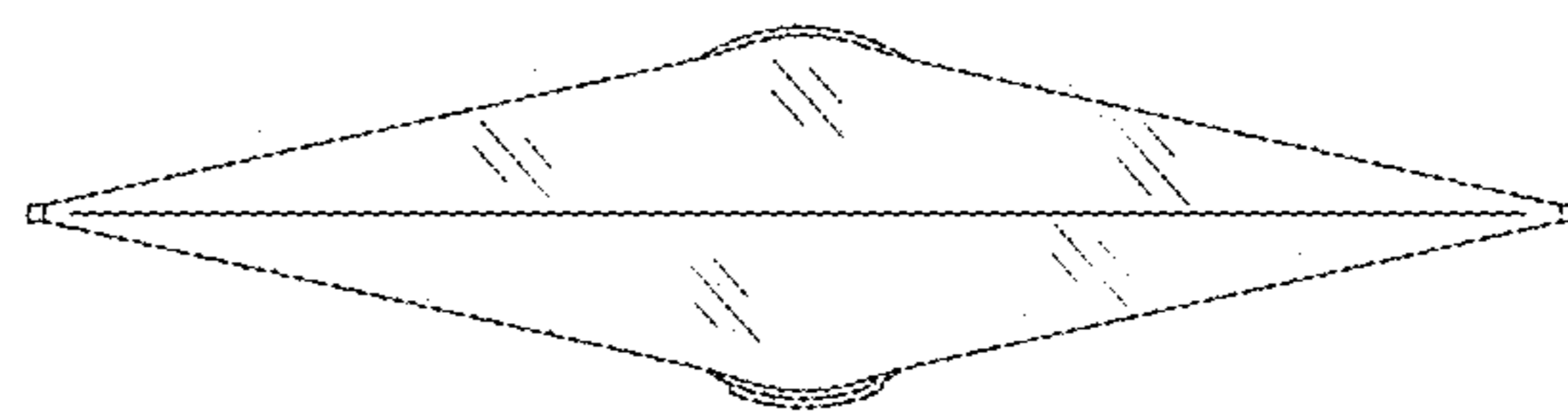

FIG. 7

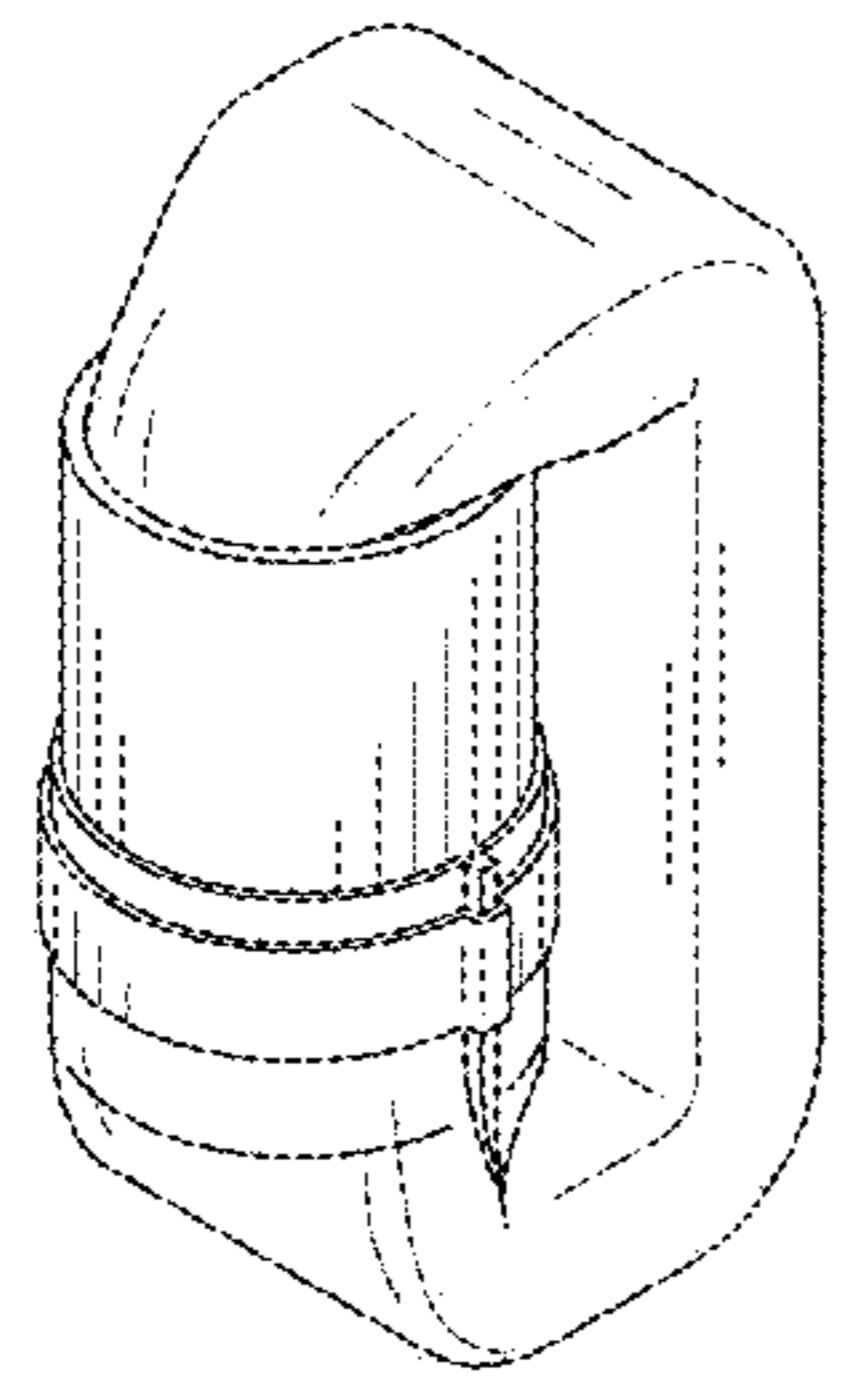

FIG. 8

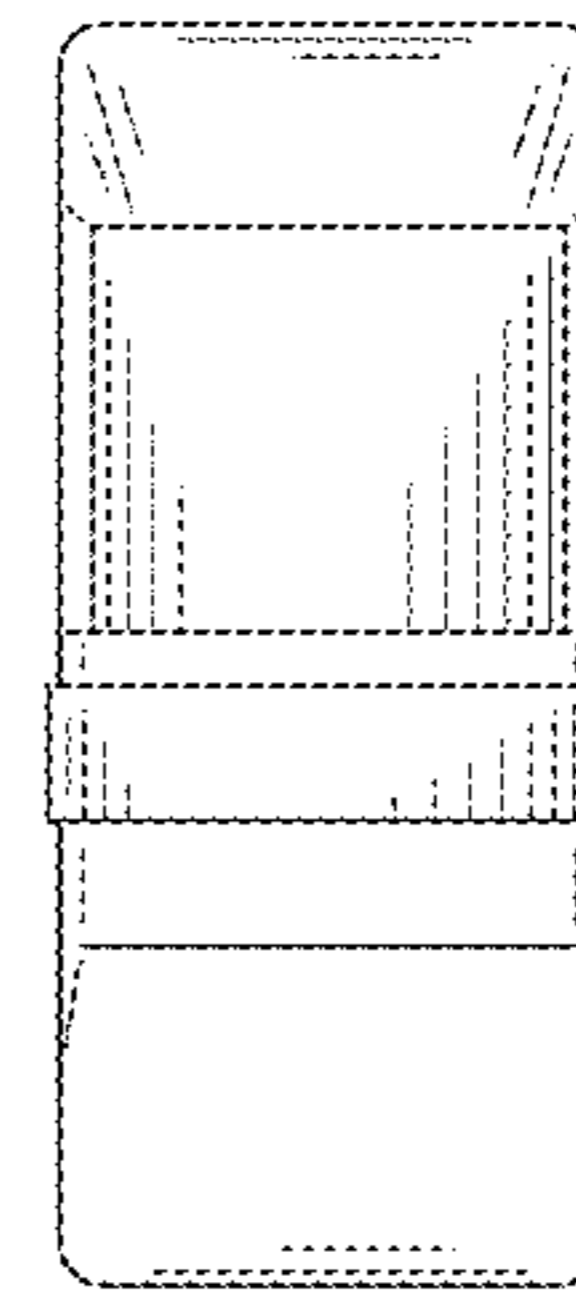

FIG. 9

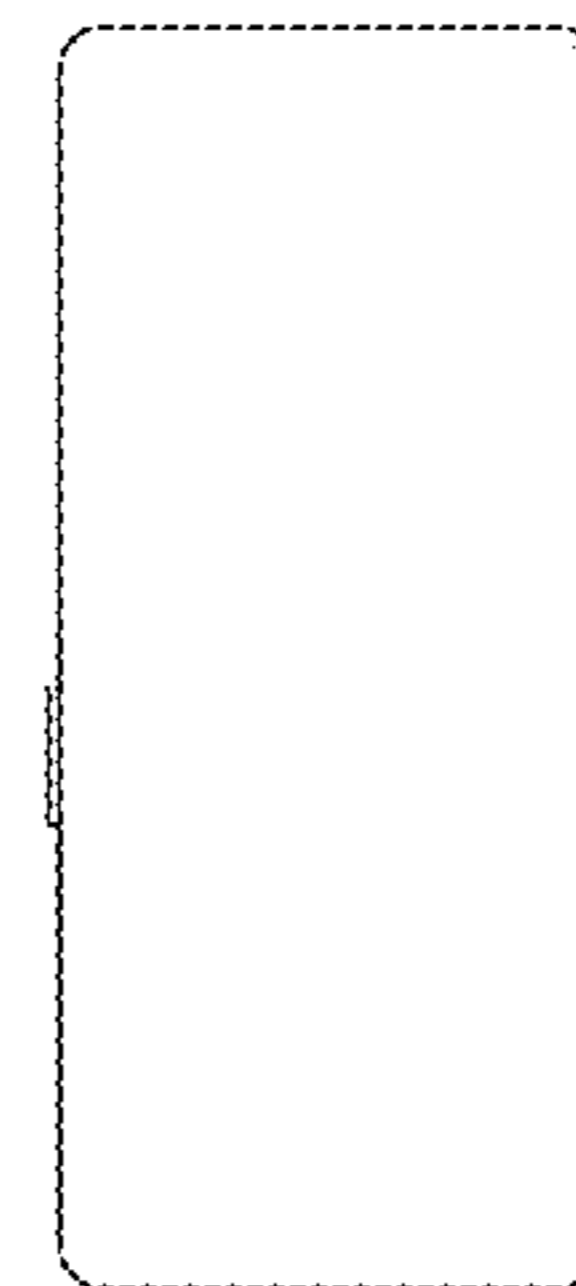

FIG. 10

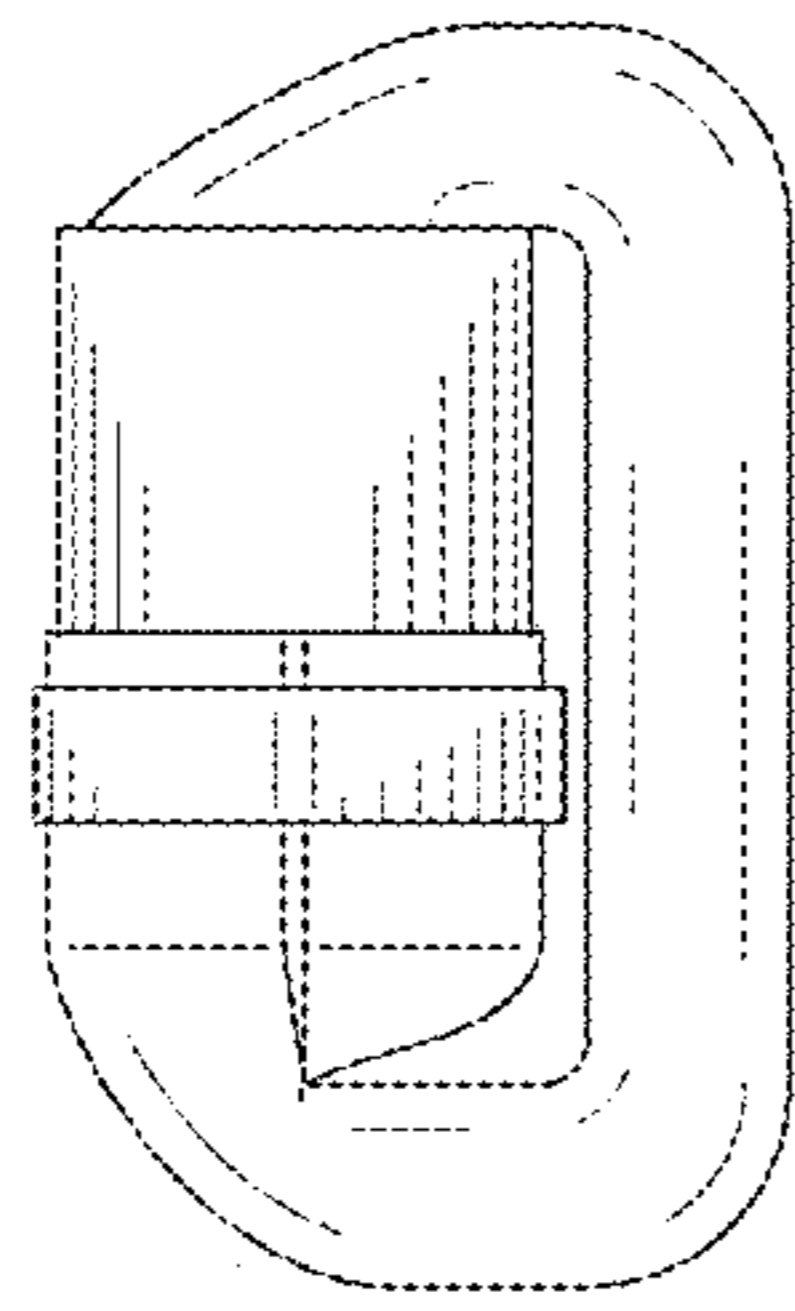

FIG. 11

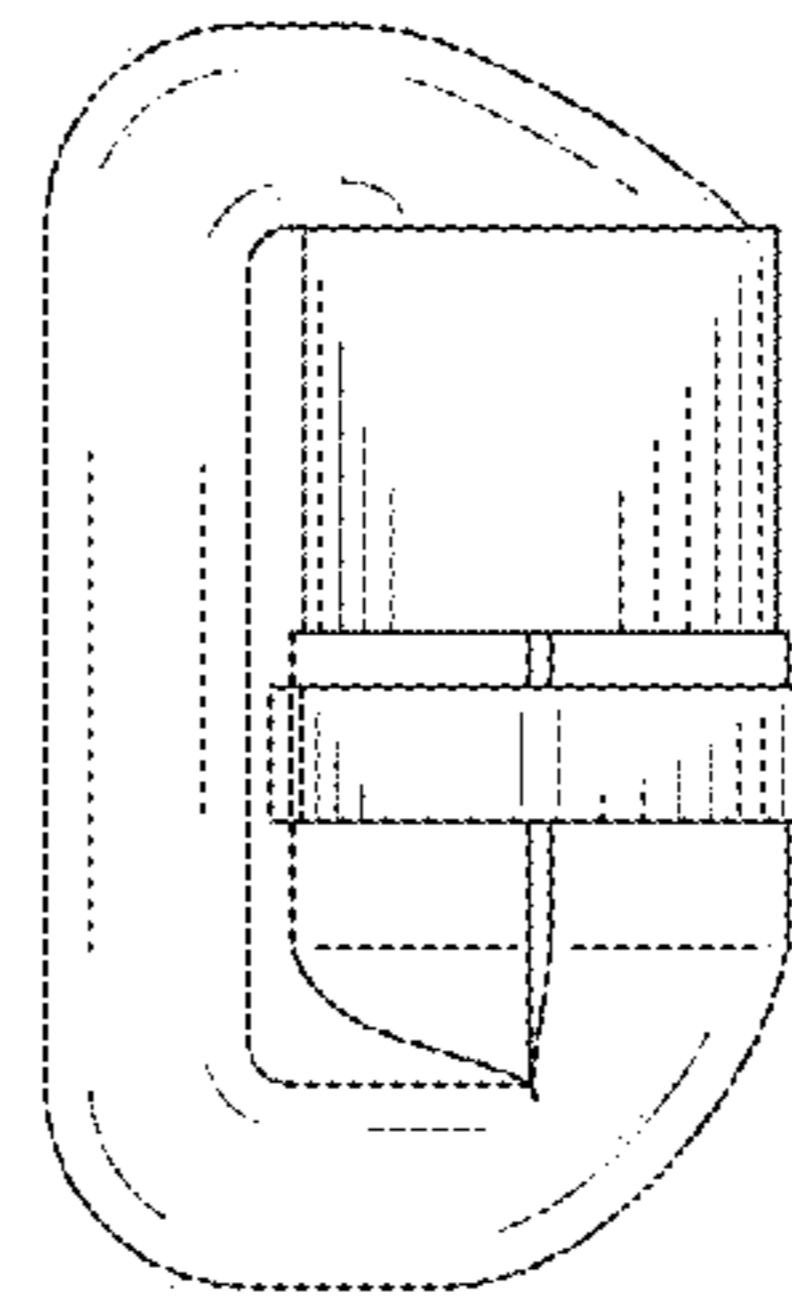

FIG. 12

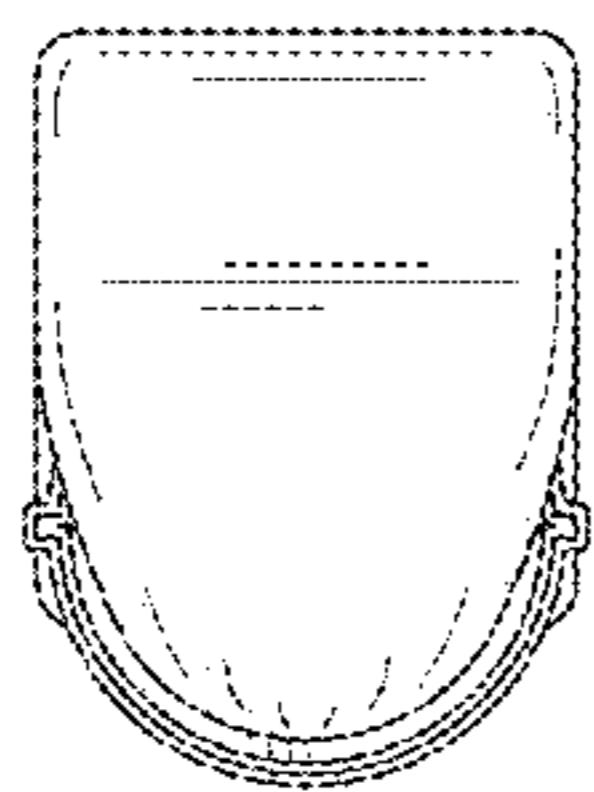

FIG. 13

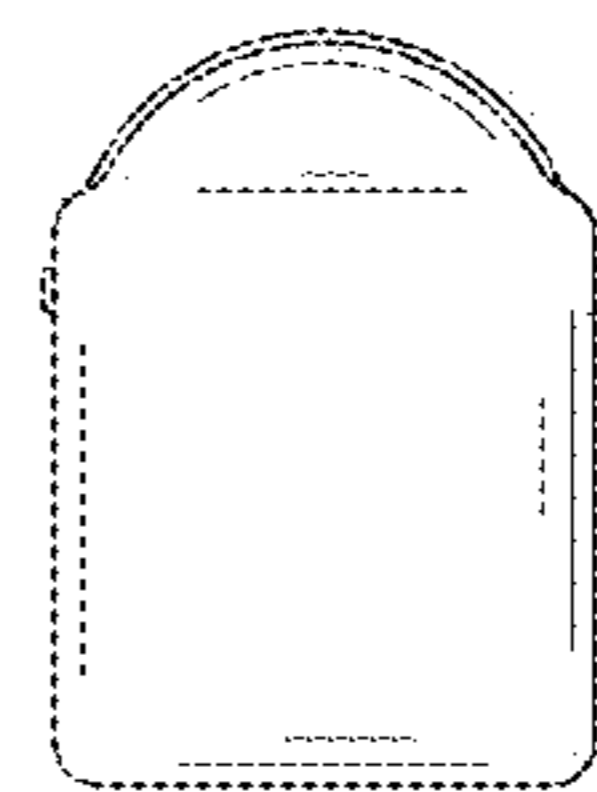

FIG. 14