



US00D945582S

(12) **United States Design Patent** (10) **Patent No.:** **US D945,582 S**  
**Baldwin et al.** (45) **Date of Patent:** **\*\* Mar. 8, 2022**

(54) **DELIVERY DEVICE FOR AN AIR TREATMENT COMPOSITION**  
 (71) Applicant: **Reckitt & Colman (Overseas) Hygiene Home Limited, Slough (GB)**  
 (72) Inventors: **Lucy Baldwin, Bristol (GB); Russell Beard, Bristol (GB); Niall McRiner, Bristol (GB); John Mouatt, Slough (GB)**  
 (73) Assignee: **Reckitt & Colman (Overseas) Hygiene Home Limited, Slough (GB)**

D533,930 S \* 12/2006 Keller, Jr. .... D23/366  
 D559,373 S \* 1/2008 Kennedy ..... D23/366  
 D559,965 S \* 1/2008 Kennedy ..... D23/366  
 D561,882 S \* 2/2008 Kennedy ..... D23/366  
 D561,883 S \* 2/2008 Cantoni ..... D23/366  
 D567,920 S \* 4/2008 Cantoni ..... D23/366  
 D567,921 S \* 4/2008 Bellofatto ..... D23/366  
 D567,922 S \* 4/2008 Turchi ..... D23/366  
 D567,923 S \* 4/2008 Turchi ..... D23/366  
 D567,924 S \* 4/2008 Turchi ..... D23/366  
 D568,454 S \* 5/2008 Bellofatto ..... D23/366  
 D568,978 S \* 5/2008 Kennedy ..... D23/366  
 D573,705 S \* 7/2008 Turchi ..... D23/366  
 D647,608 S \* 10/2011 Young ..... D23/366  
 8,119,072 B2 \* 2/2012 D'Amico ..... A61L 9/03  
 422/126  
 D657,040 S \* 4/2012 Young ..... D23/367  
 D875,230 S \* 2/2020 Gobber ..... D23/366  
 D905,221 S \* 12/2020 Gobber ..... D23/366

(\*\*) Term: **15 Years**  
 (21) Appl. No.: **29/760,432**  
 (22) Filed: **Dec. 1, 2020**

(30) **Foreign Application Priority Data**  
 Jun. 3, 2020 (EP) ..... 007981360-0002  
 (51) **LOC (13) Cl.** ..... **23-04**  
 (52) **U.S. Cl.**  
 USPC ..... **D23/355**  
 (58) **Field of Classification Search**  
 USPC ..... D23/355-366, 352, 369, 332, 333, 335,  
 D23/336, 342, 351; 422/120, 122;  
 55/356, 473, 504; 96/97; 261/DIG. 17,  
 261/DIG. 65, DIG. 88, DIG. 31  
 CPC .. A61L 9/16; A61L 9/22; B01D 47/00; B01D  
 47/027; B01D 2221/02; B01D 2259/4508;  
 B03C 3/155; B03C 3/368; F24F 3/16;  
 F24F 13/20; F24F 13/28  
 See application file for complete search history.

(56) **References Cited**  
 U.S. PATENT DOCUMENTS  
 D515,192 S \* 2/2006 Smith ..... D23/366  
 D520,128 S \* 5/2006 Caserta ..... D23/366

\* cited by examiner  
*Primary Examiner* — David G Muller  
 (74) *Attorney, Agent, or Firm* — Norris McLaughlin PA

(57) **CLAIM**  
 The ornamental design for a delivery device for an air treatment composition, as shown and described.

**DESCRIPTION**  
 FIG. 1 is a top perspective view of the delivery device for an air treatment composition;  
 FIG. 2 is a front, elevation view thereof;  
 FIG. 3 is a rear, elevation view thereof;  
 FIG. 4 is a first side, elevation view thereof;  
 FIG. 5 is a second side, elevation view thereof;  
 FIG. 6 is a top, plan view thereof; and,  
 FIG. 7 is a bottom, plan view thereof.  
 Features illustrated in the various drawing figures which are depicted using broken-lines form no part of the claimed design.

**1 Claim, 7 Drawing Sheets**

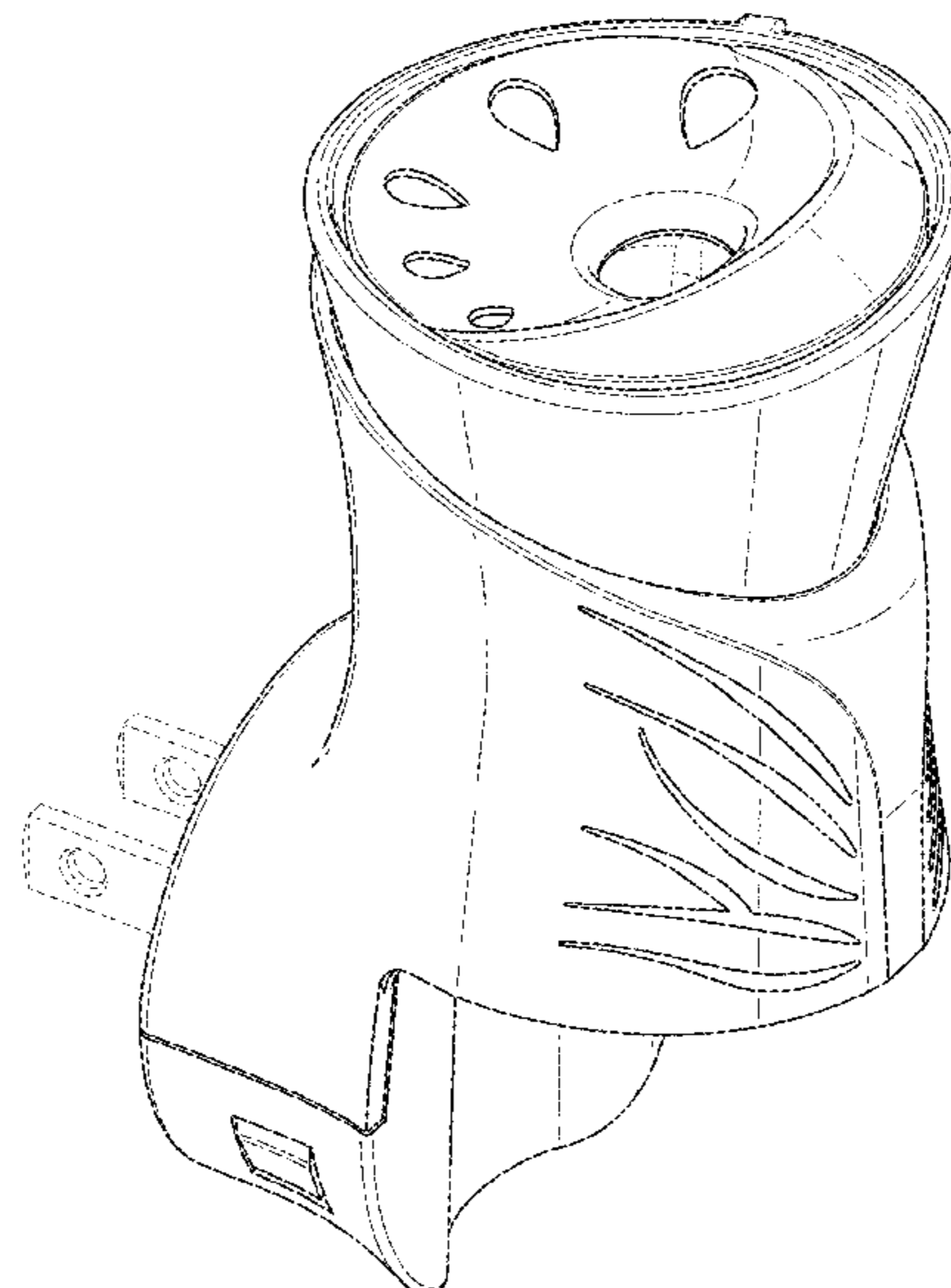

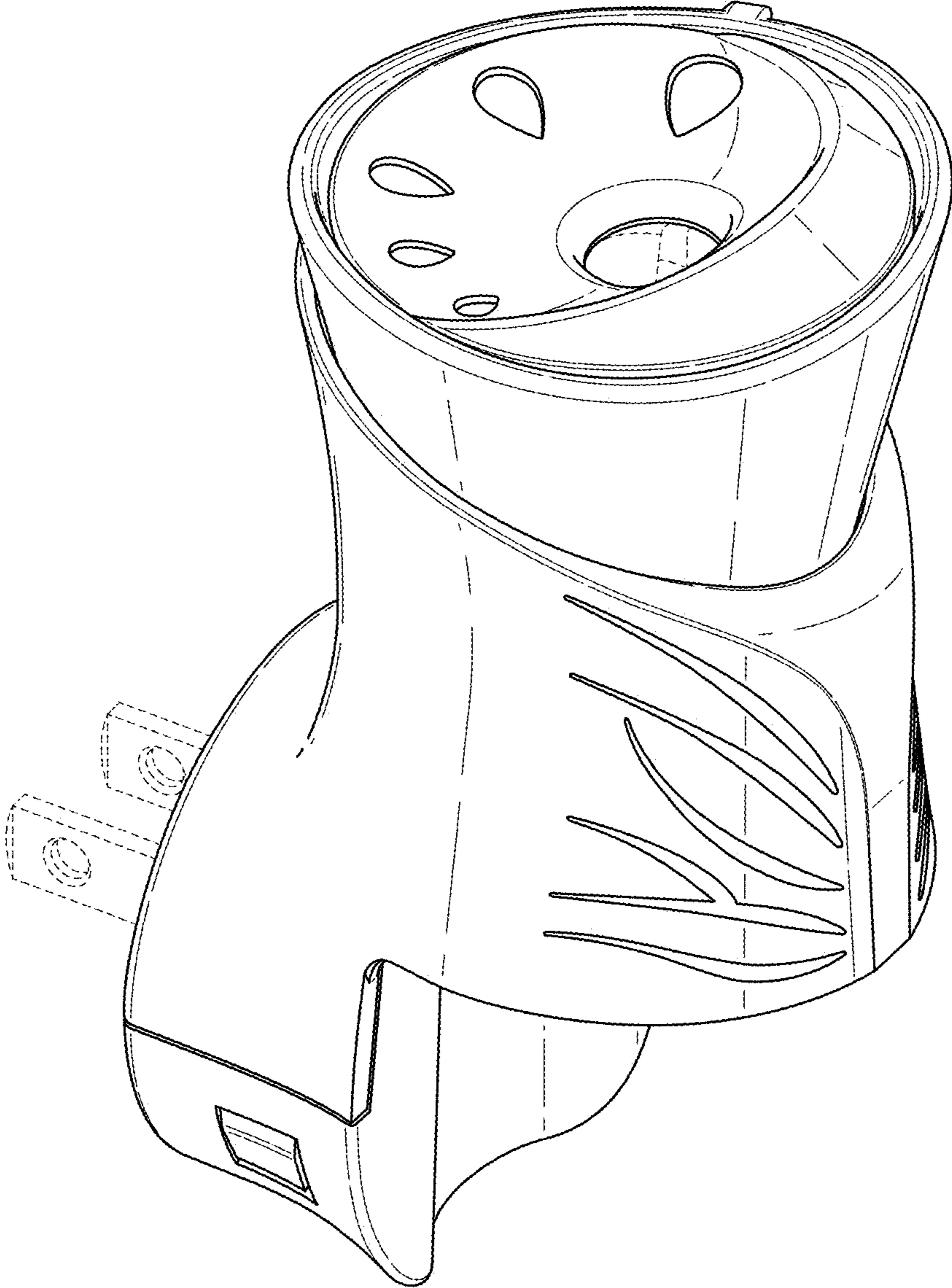

Fig. 1

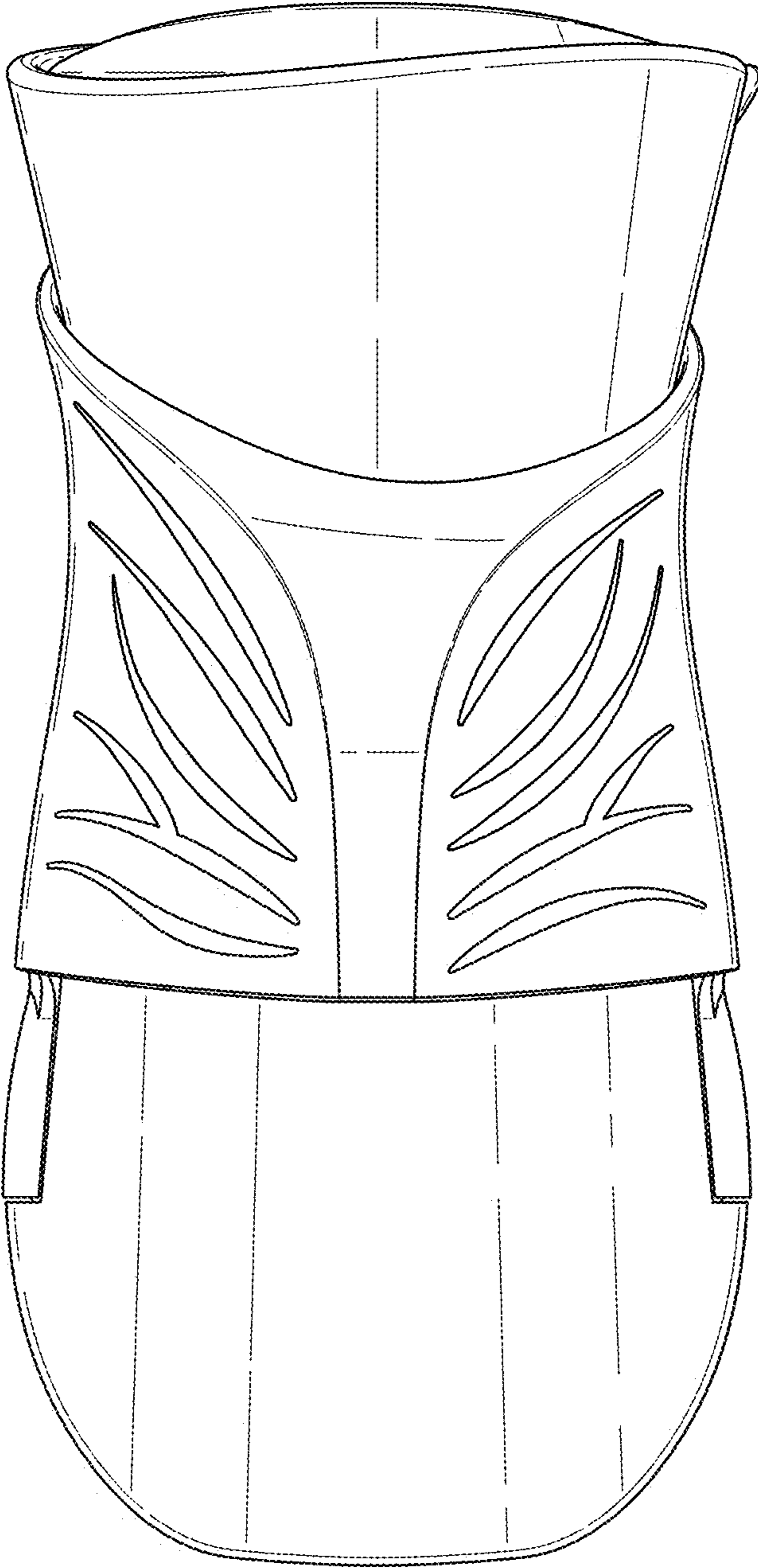

Fig. 2

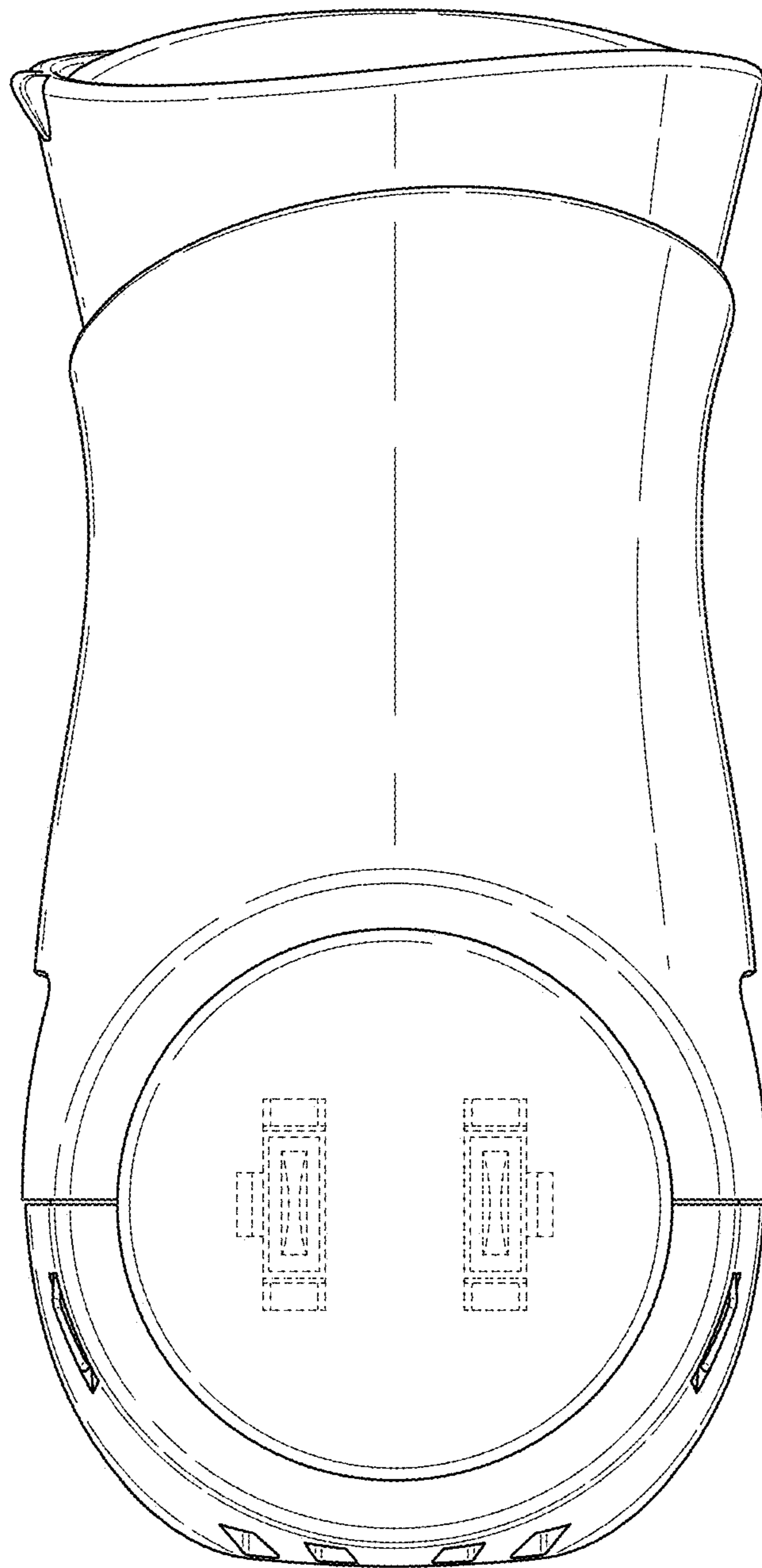

Fig. 3

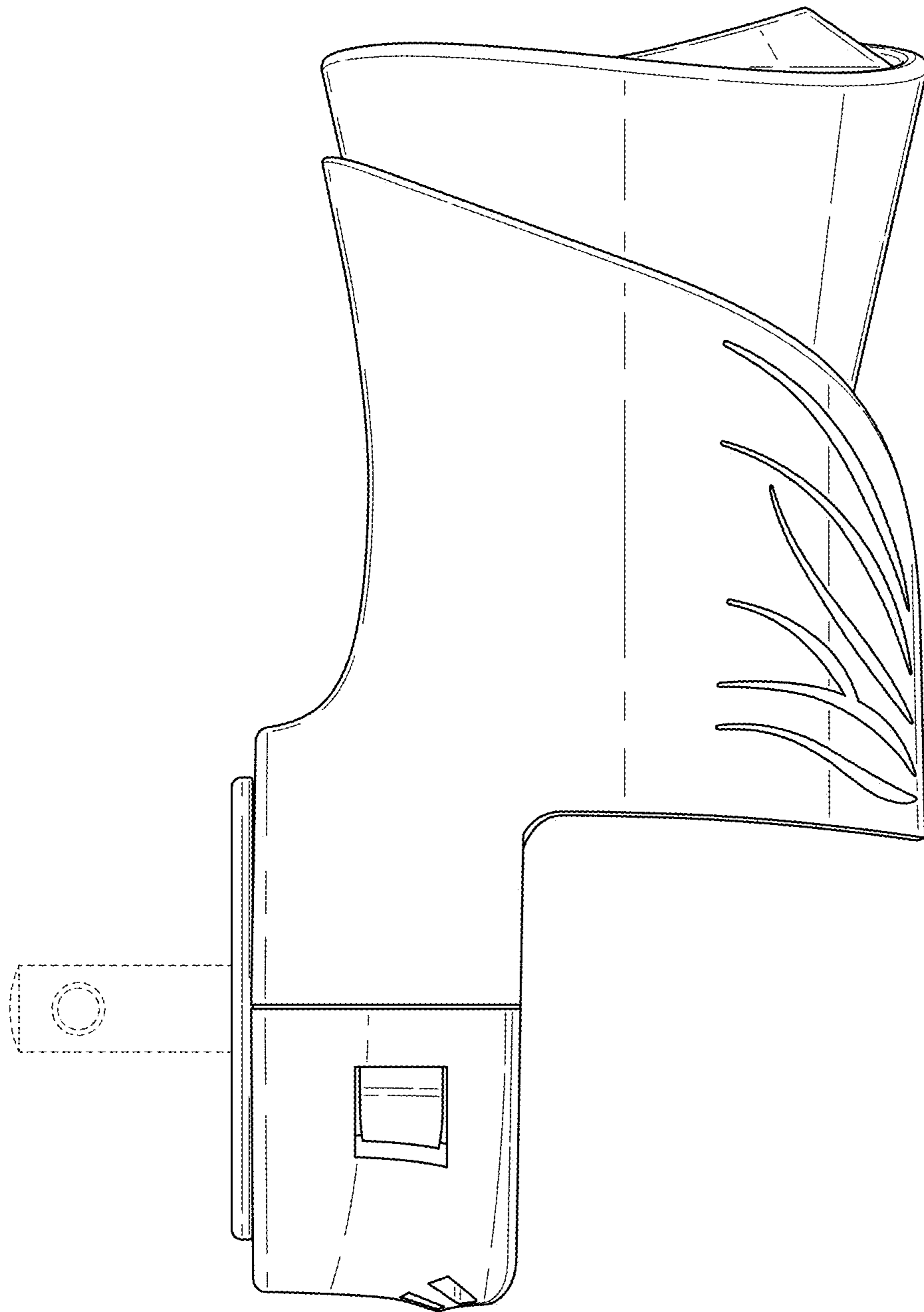

Fig. 4

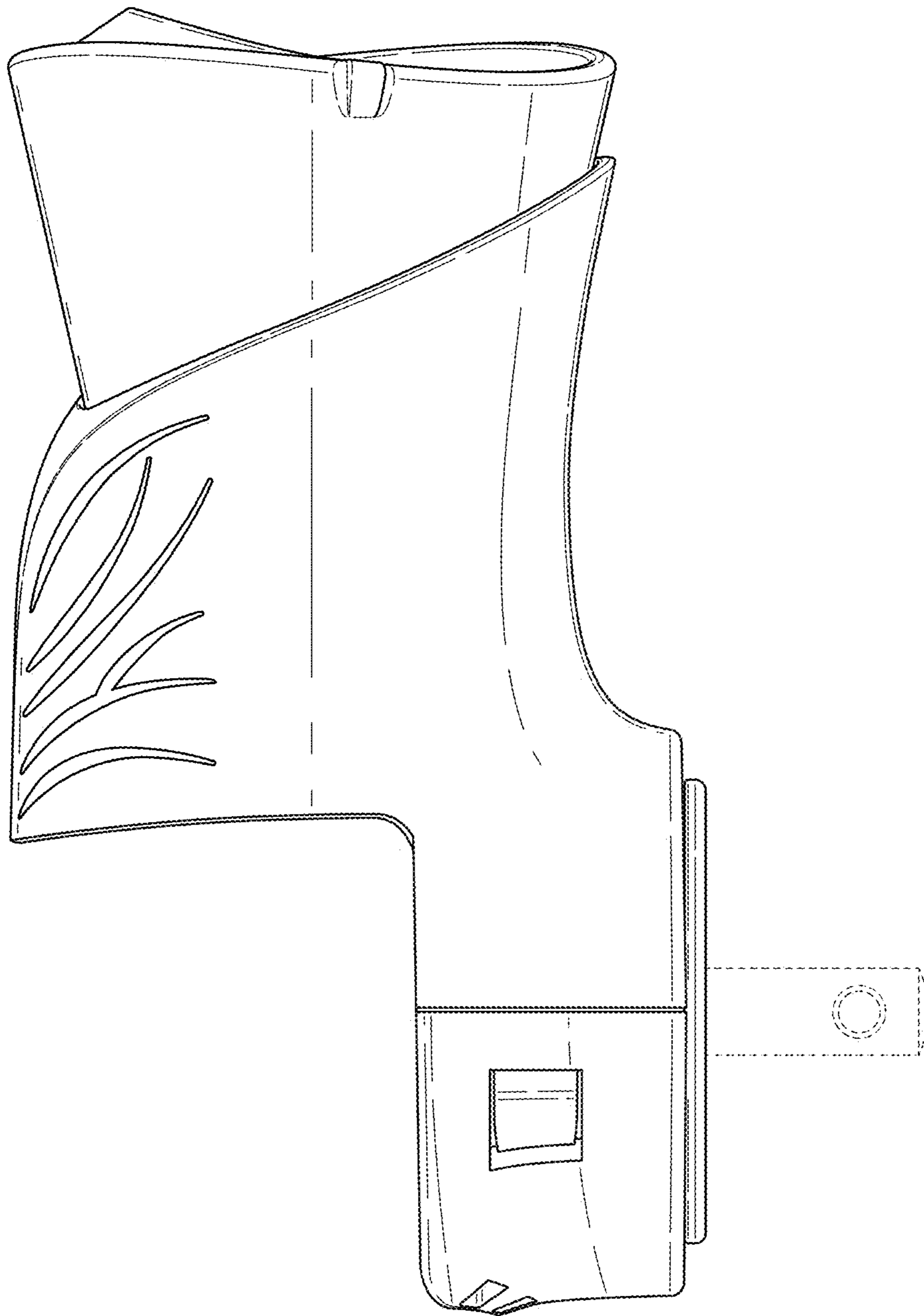

Fig. 5

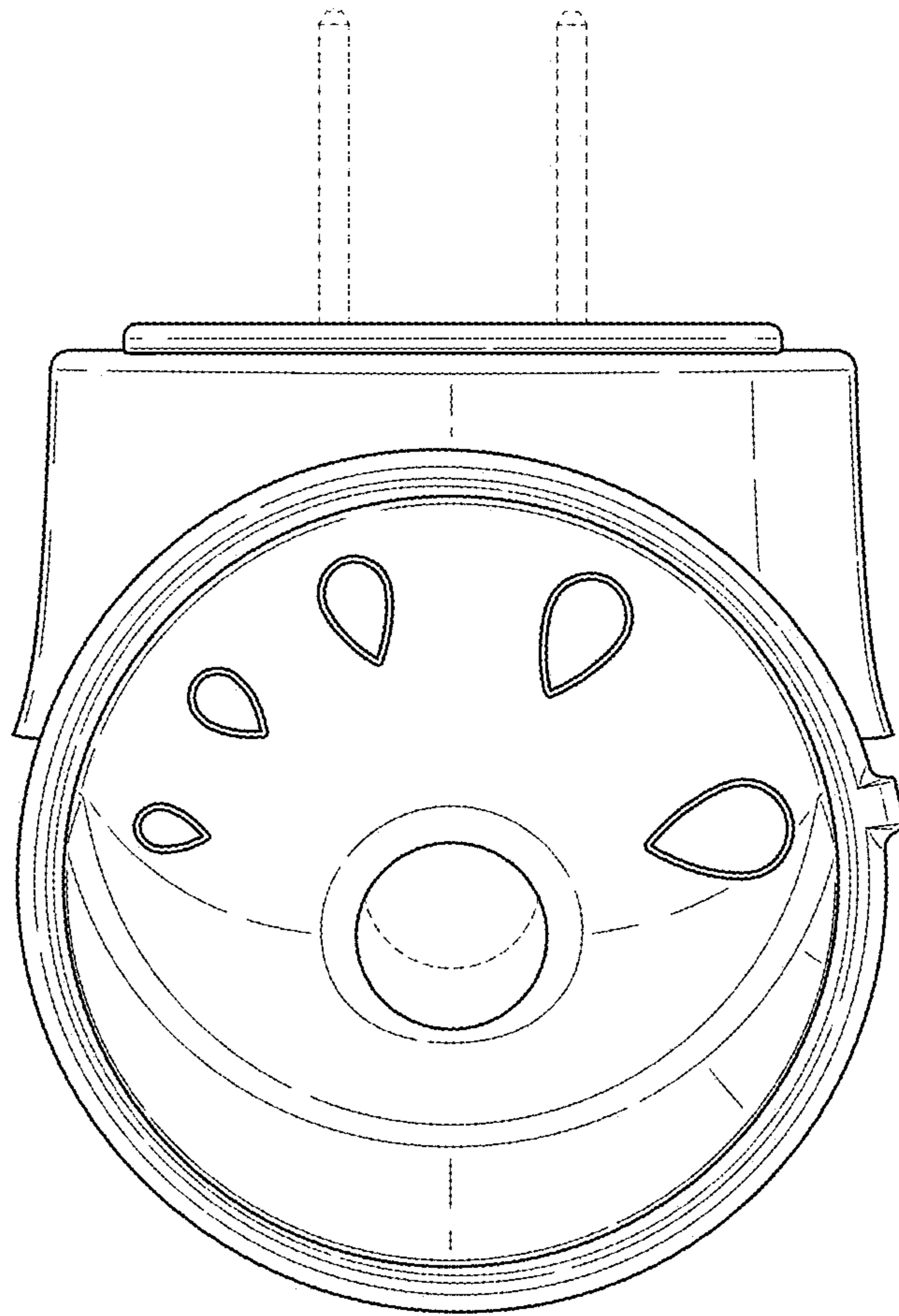

Fig. 6

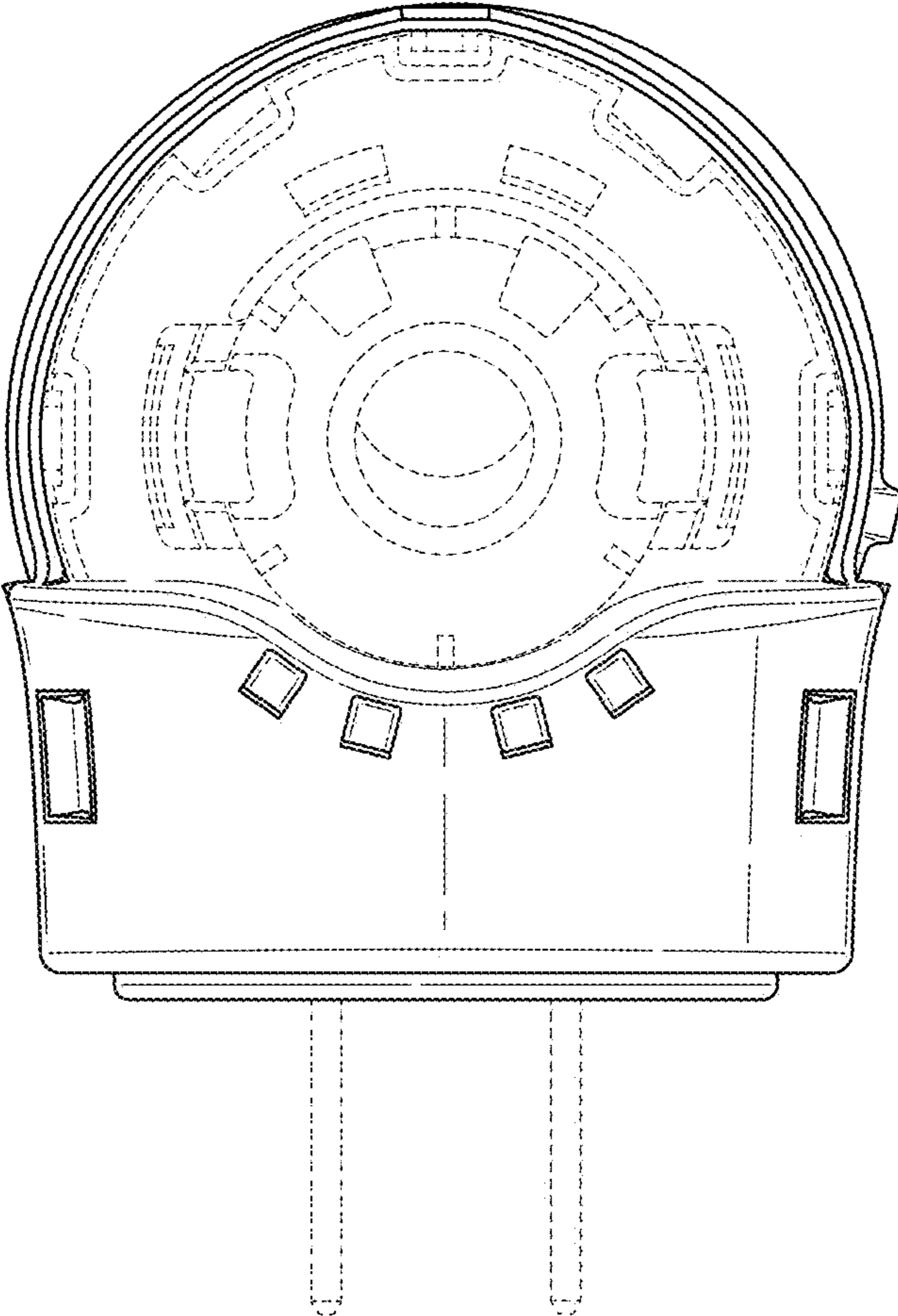

Fig. 7