

US00D945312S

(12) **United States Design Patent**
Michael et al.

(10) **Patent No.:** **US D945,312 S**
(45) **Date of Patent:** **** Mar. 8, 2022**

(54) **BELT LOOP**

- (71) Applicant: **Vista Outdoor Operations LLC**, Anoka, MN (US)
- (72) Inventors: **Christopher J. Michael**, Belgrade, MT (US); **Daniel D. Sereday**, Belgrade, MT (US)
- (73) Assignee: **Vista Outdoor Operations LLC**, Anoka, MN (US)
- (**) Term: **15 Years**
- (21) Appl. No.: **29/730,740**
- (22) Filed: **Apr. 8, 2020**

Related U.S. Application Data

- (63) Continuation of application No. 16/715,865, filed on Dec. 16, 2019.
- (51) **LOC (13) Cl.** **02-07**
- (52) **U.S. Cl.**
USPC **D11/214; D3/222**
- (58) **Field of Classification Search**
USPC D3/201, 215, 222, 224, 226, 228, 318, D3/323, 324; D11/87, 94, 200, 201,
(Continued)

(56) **References Cited**

U.S. PATENT DOCUMENTS

- 2,074,287 A * 3/1937 Tavani A44B 11/00
24/316
- 4,326,280 A * 4/1982 Perry, Jr. A45F 5/02
224/163

(Continued)

FOREIGN PATENT DOCUMENTS

GBRGN-9007812771-0001 * 4/2020

OTHER PUBLICATIONS

Workouty_2_Pcs_Lot_Large_Nylon_Belt_Clips (available online Aug. 31, 2017) Retrieved from the internet May 8, 2021 from URL: <https://www.amazon.com/Workouty-Outdoor-Sheath-Holster-Camping/dp/B08224SQ1D>.*

(Continued)

Primary Examiner — Richard Kearney

(74) *Attorney, Agent, or Firm* — Reed Smith LLP; Matthew P. Frederick; Cheryl L. Gastineau

(57) **CLAIM**

The ornamental design for a belt loop, as shown and described.

DESCRIPTION

FIG. 1 is a top perspective view of a belt loop in accordance with my new design, of the interior thereof, in an open position;
 FIG. 2 is a bottom perspective view of the exterior thereof, in an open position;
 FIG. 3 is a bottom perspective view of the interior thereof, in an open position;
 FIG. 4 is top perspective view of the exterior thereof, in an open position;
 FIG. 5 is a rear view of the interior thereof, in an open position;
 FIG. 6 is a front view of the exterior thereof, in an open position;
 FIG. 7 is a right side view thereof, in an open position;
 FIG. 8 is a left side view thereof, in an open position;
 FIG. 9 is a top view thereof, in an open position;
 FIG. 10 is a bottom view thereof, in an open position;
 FIG. 11 is a top, front perspective view thereof, in a closed position;
 FIG. 12 is a bottom, rear perspective view thereof, in a closed position;
 FIG. 13 is a bottom, front perspective view thereof, in a closed position;
 FIG. 14 is a top, rear perspective view thereof, in a closed position;
 FIG. 15 is a front view thereof, in a closed perspective;

(Continued)

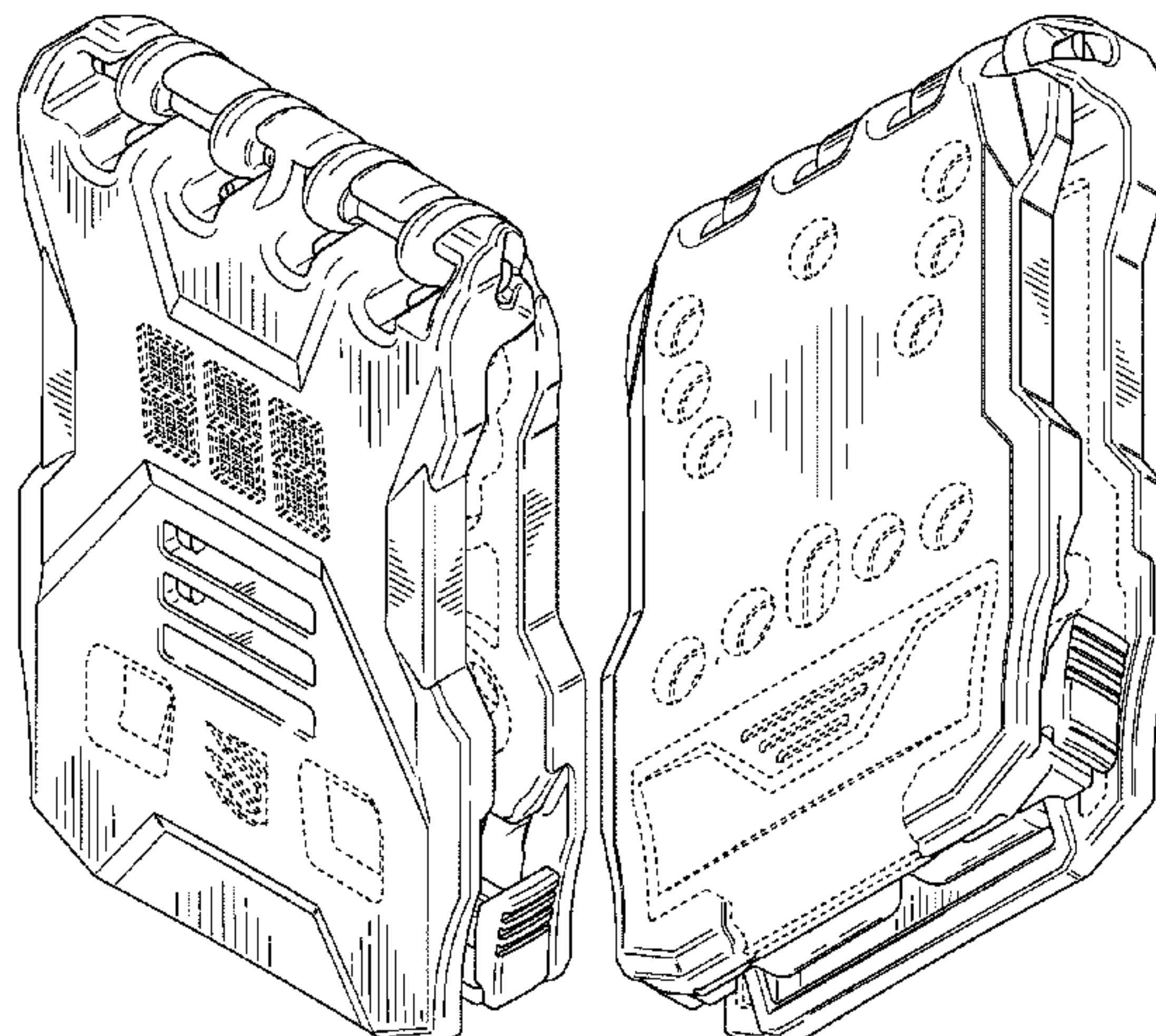

FIG. 16 is a front view thereof, in a closed perspective;
 FIG. 17 is a left side view thereof, in a closed position;
 FIG. 18 is a right side view thereof, in a closed position;
 FIG. 19 is a top view thereof, in a closed position; and,
 FIG. 20 is a bottom view thereof, in a closed position.
 The broken lines in the figures illustrate portions of the belt
 loop that form no part of the claimed design.

1 Claim, 16 Drawing Sheets

(58) **Field of Classification Search**

USPC D11/208–210, 212, 214, 215, 216, 218,
 D11/220, 221, 228; D24/184; D29/100,
 D29/122; D30/139, 152, 153; D22/108
 CPC A44B 11/00; A44B 11/001; A44B 11/006;
 A44B 11/04; A44B 11/06; A44B 11/065;
 A44B 11/18; A44B 11/20; A44B 11/2538;
 A44B 13/0047; A44B 19/00; A44B
 19/26; Y10T 24/498; Y10T 24/1467;
 Y10T 24/1488; B65D 65/06; A45F 3/005;
 A45F 3/14; A45F 2003/144; A45F 5/021;
 A45F 2200/0516; A45F 2200/0575; F41C

(56)

References Cited

U.S. PATENT DOCUMENTS

4,387,489 A * 6/1983 Dudek A44B 11/06
 24/133
 6,145,169 A * 11/2000 Terzuola A44B 11/005
 24/163 K
 6,622,348 B1 * 9/2003 Badrenas Buscart
 A44B 11/006
 24/169
 7,657,977 B2 2/2010 Clifton, Jr.
 7,971,762 B2 7/2011 Clifton, Jr.
 D705,121 S * 5/2014 Kostal D11/214
 9,027,212 B2 * 5/2015 Wu F16B 2/10
 24/517
 9,480,328 B2 * 11/2016 Stevens A45F 5/021
 10,362,856 B2 * 7/2019 Parsons A45F 5/021
 10,786,067 B2 * 9/2020 VanHeusen A45F 3/00
 2018/0042370 A1 * 2/2018 Castedo Gomez F16B 2/20
 2019/0098782 A1 * 3/2019 Mayfield H05K 5/0204
 2020/0187632 A1 * 6/2020 Michael F41C 33/041

OTHER PUBLICATIONS

Cuzmak_1-Pack_Tactical_Belt_clips. (available online May 24, 2018)
 Retrieved from the internet May 8, 2021 from URL: https://www.amazon.com/Belt-Outdoor-Knife-Blade-Screws/dp/B07GGYQN6H/ref=sr_1_4?dchild=1&keywords=Cuzmak_1-Pack_Tactical_Belt_clips&qid=1620502141&s=hi&sr=1-4.*

* cited by examiner

33/007; F41C 33/008
 See application file for complete search history.

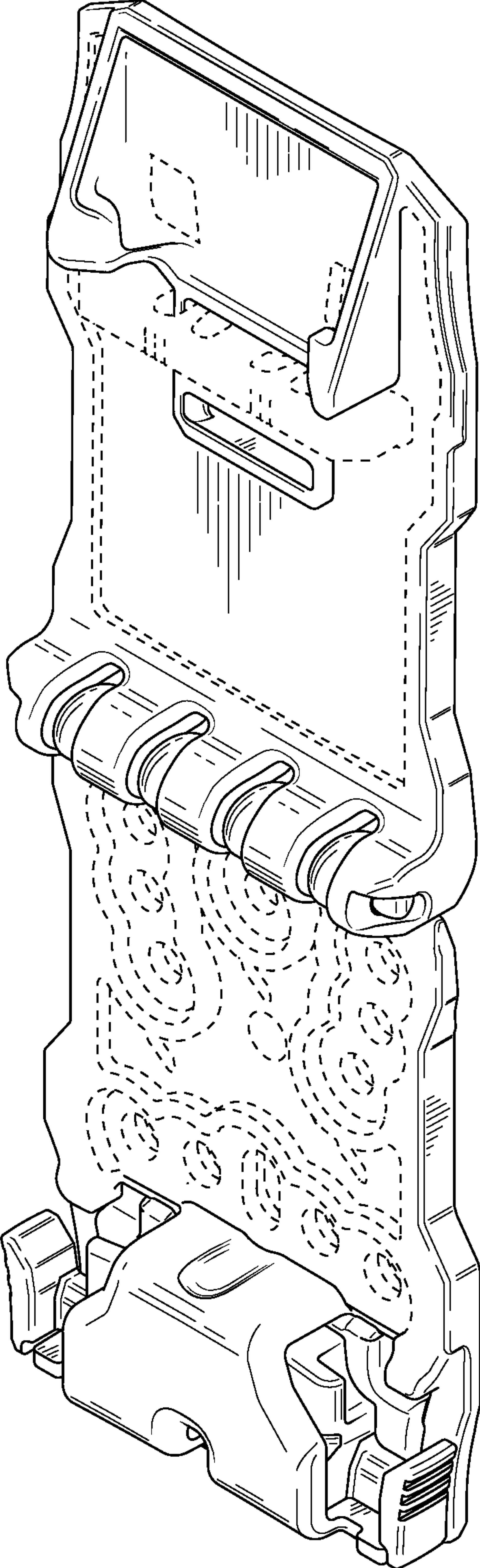

FIG. 1

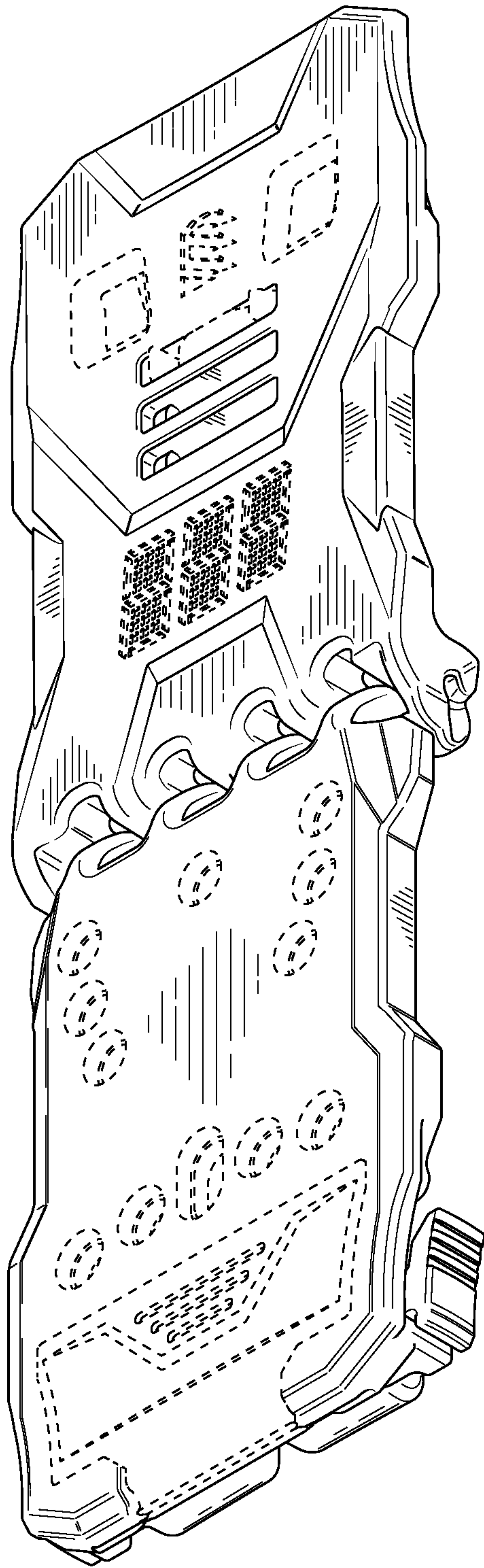

FIG. 2

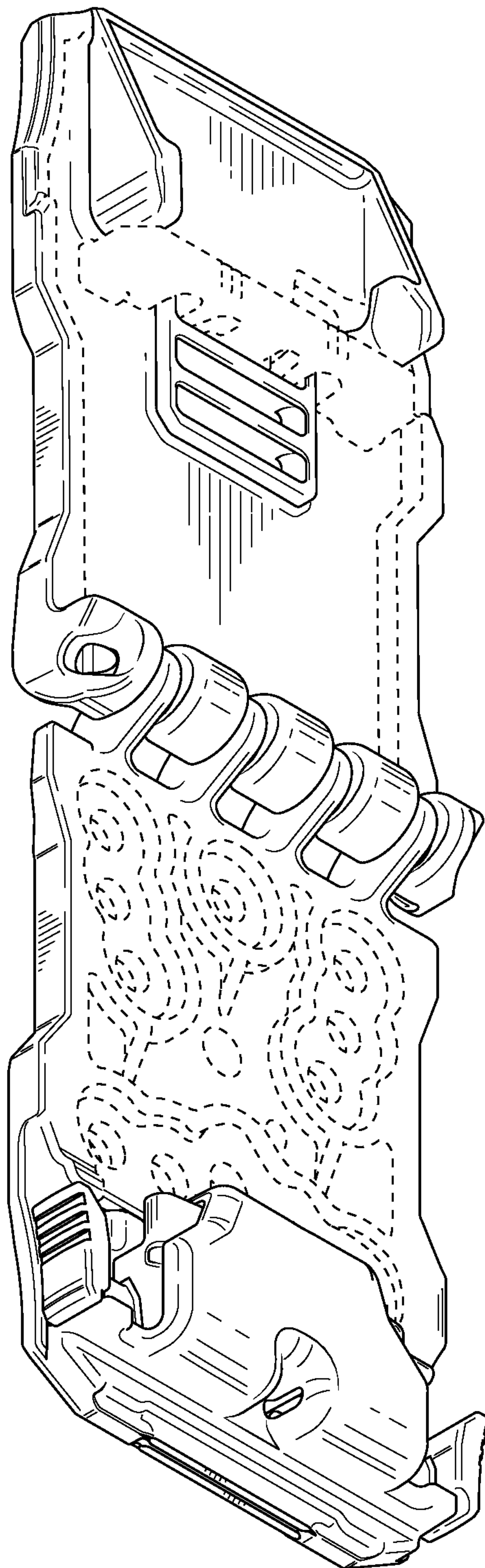

FIG. 3

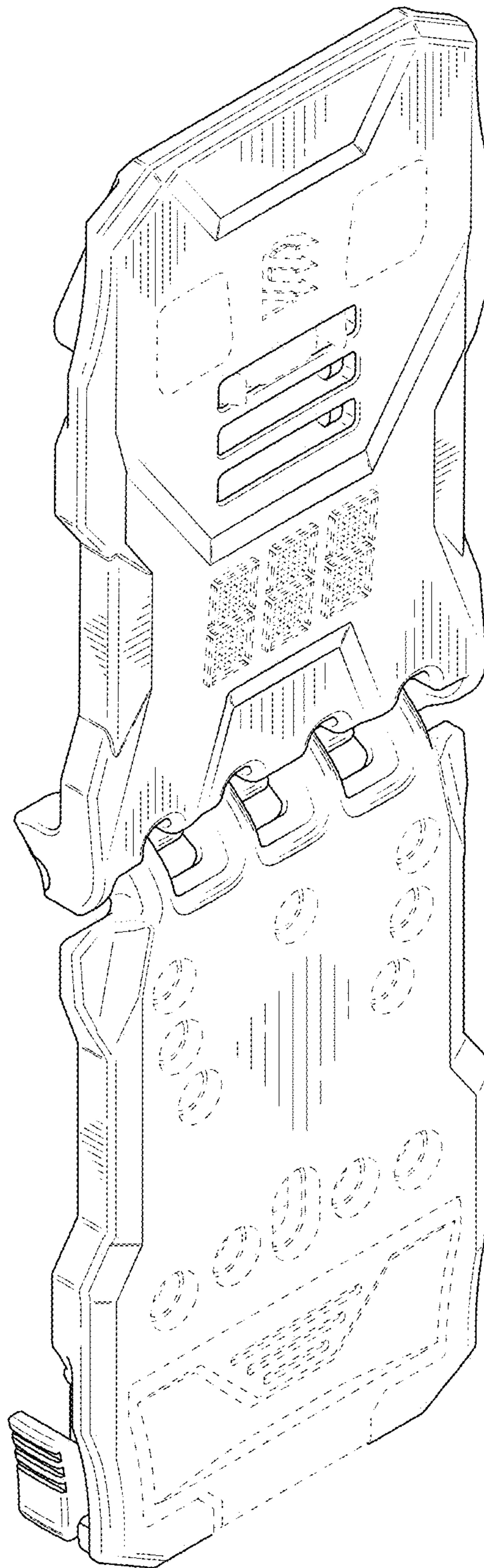

FIG. 4

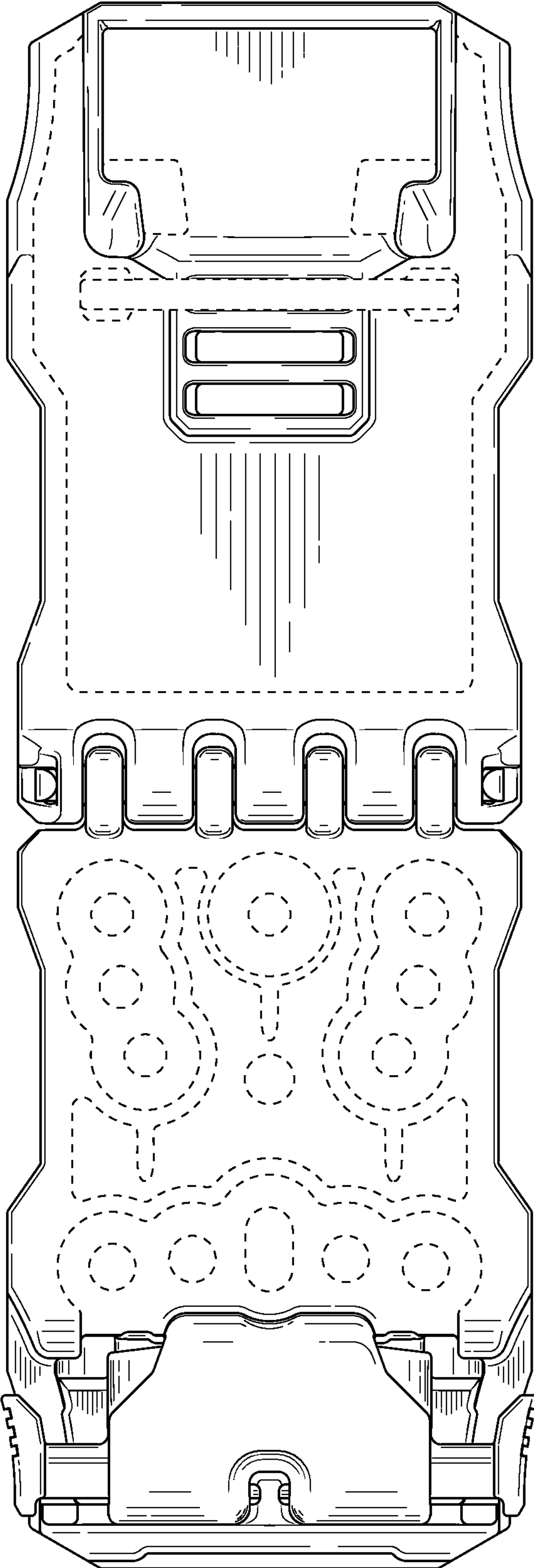

FIG. 5

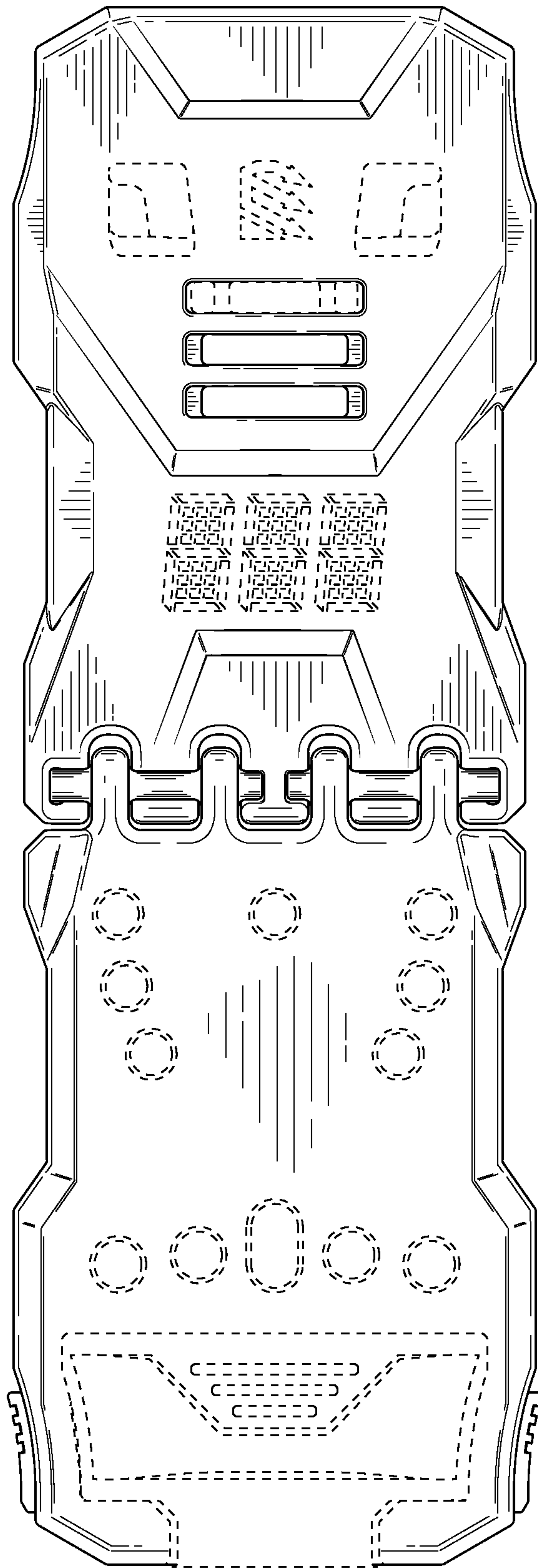

FIG. 6

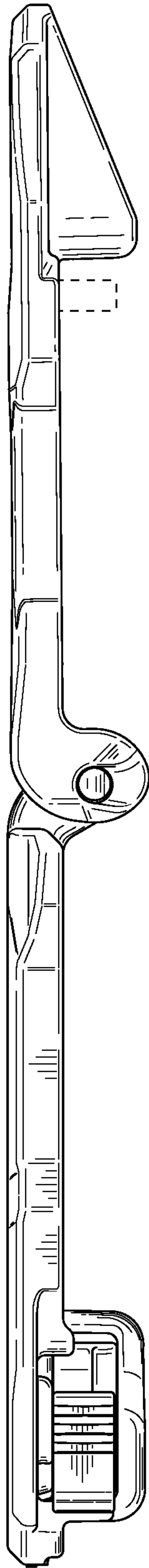

FIG. 7

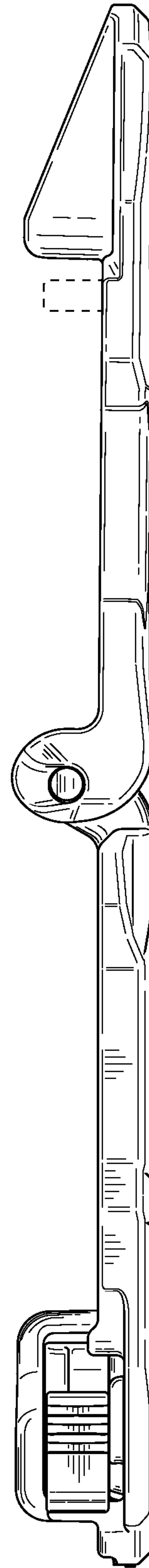

FIG. 8

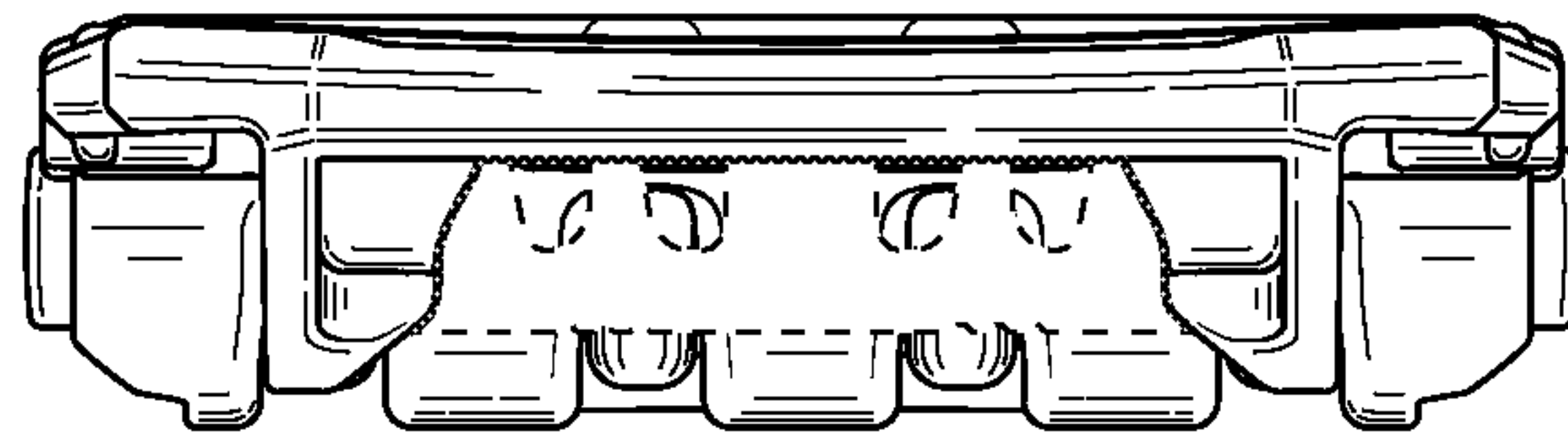

FIG. 9

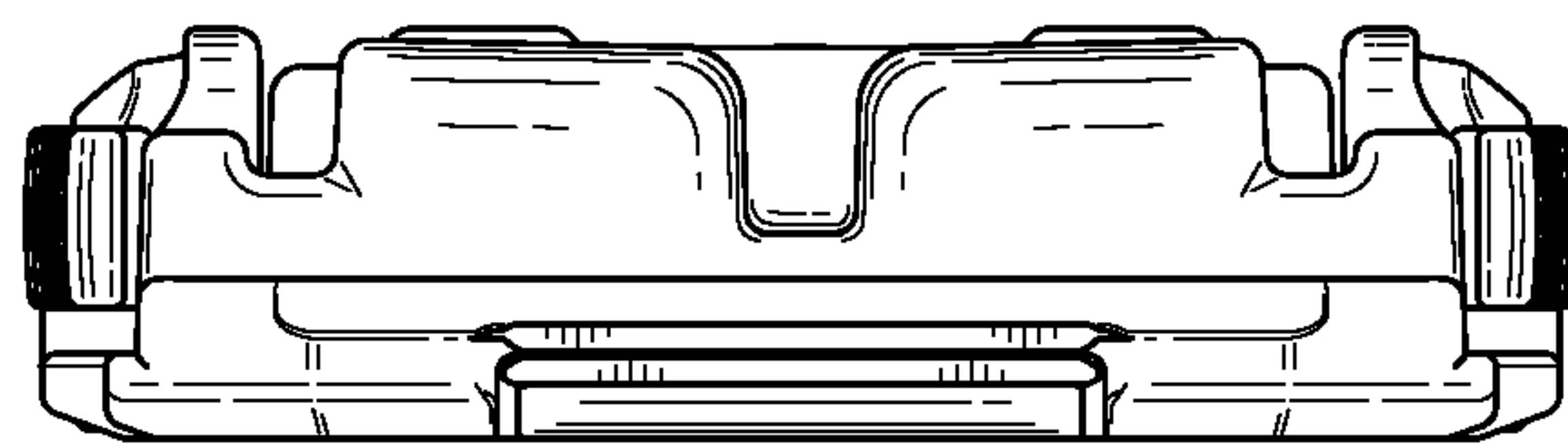

FIG. 10

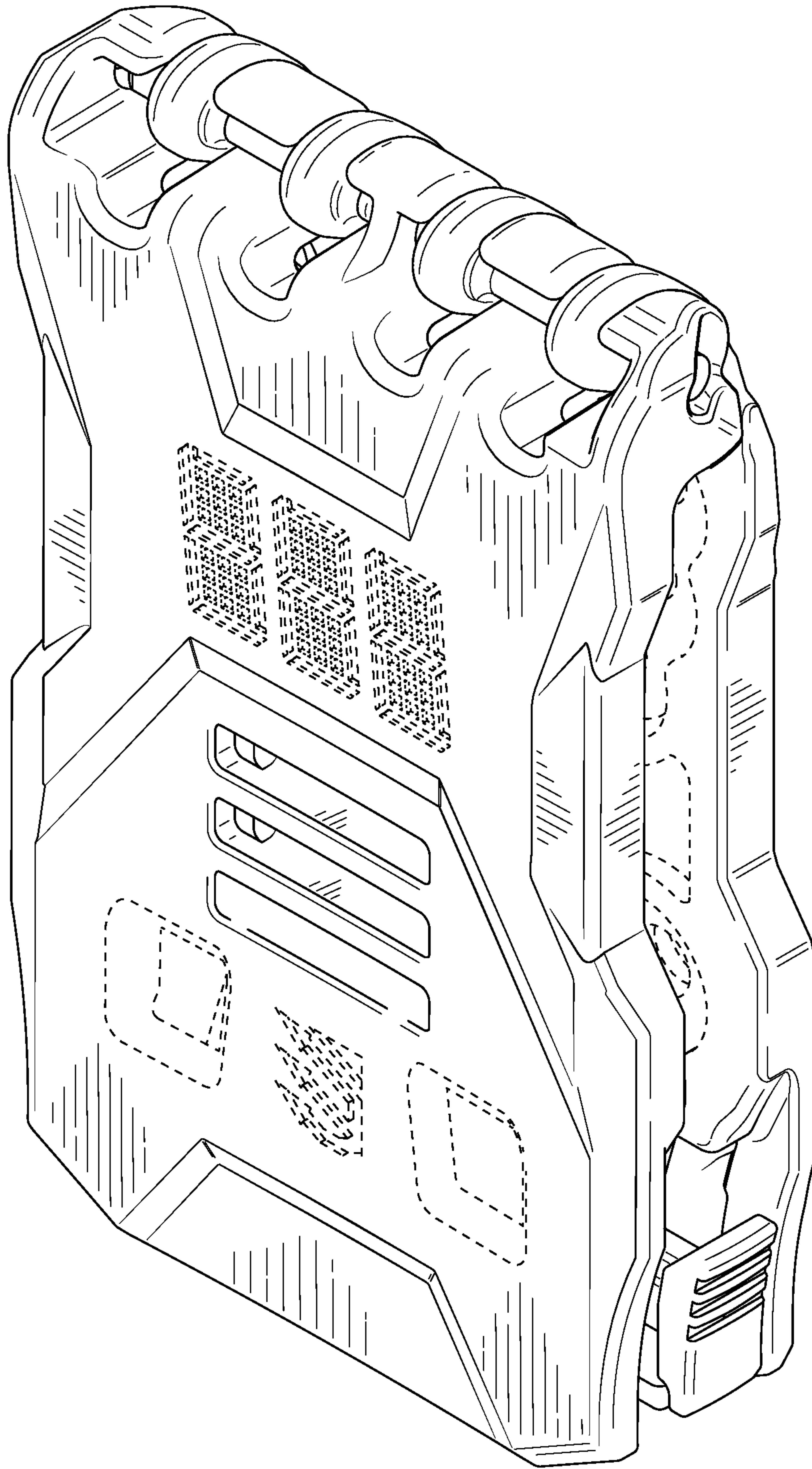

FIG. 11

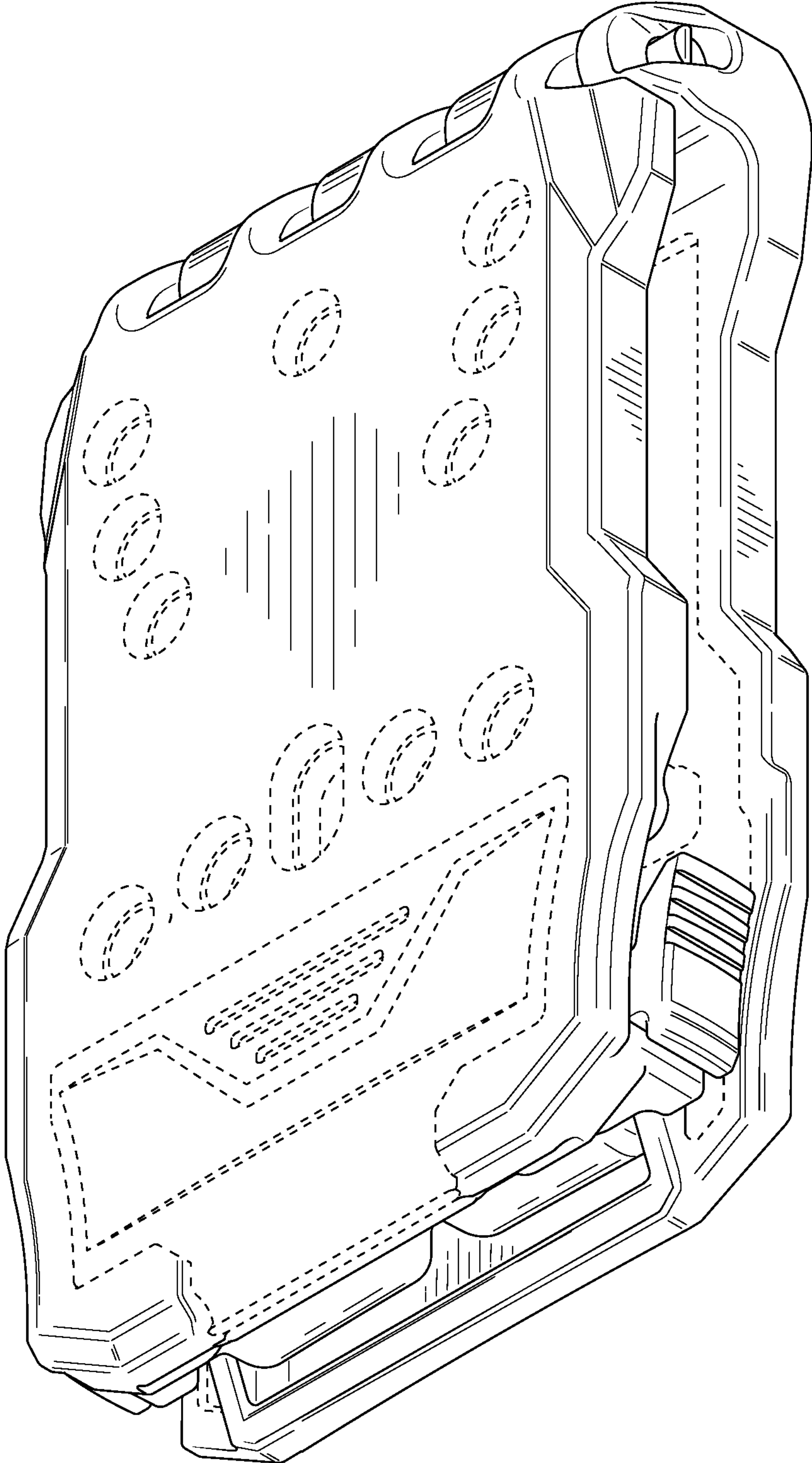

FIG. 12

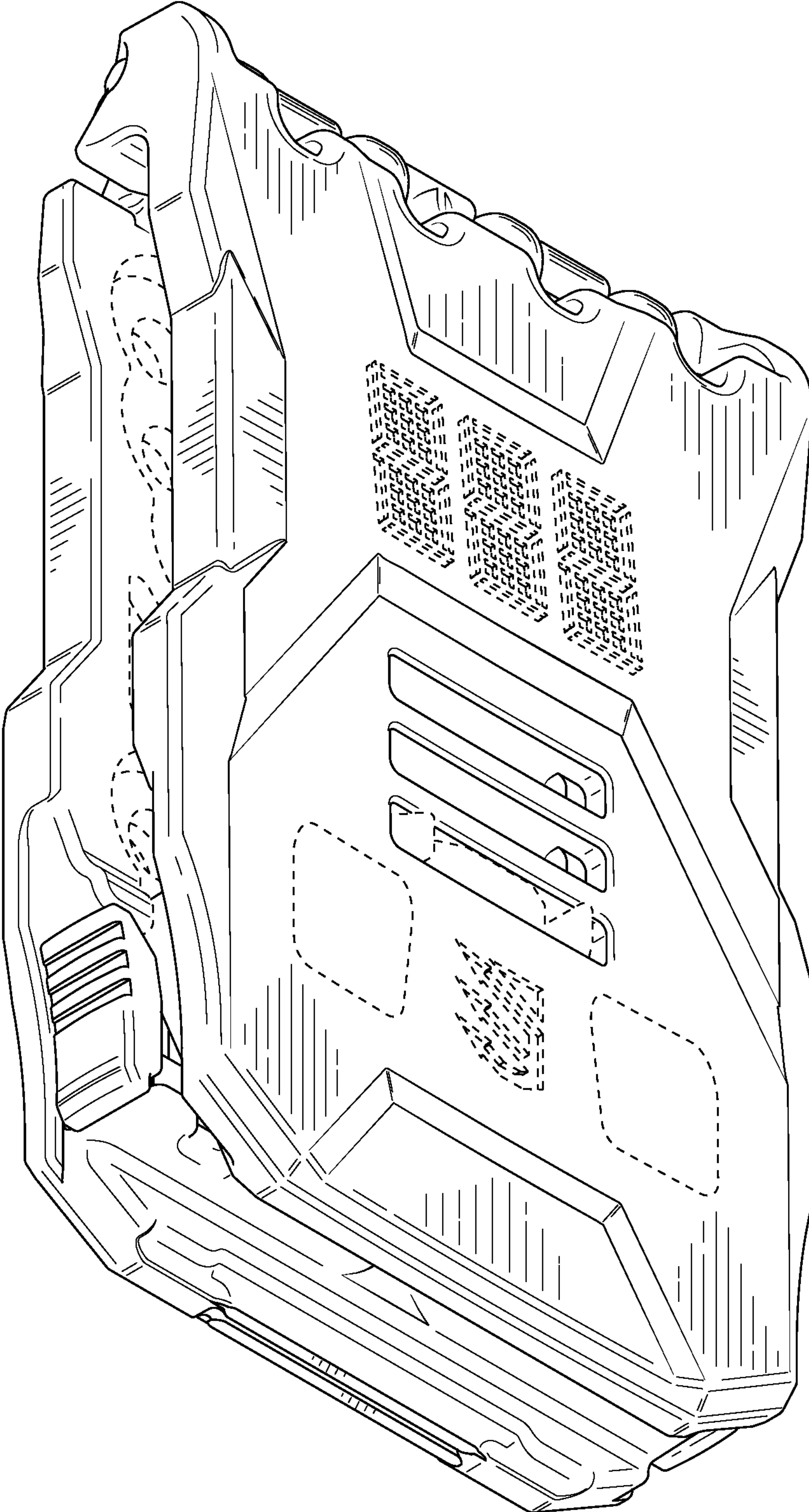

FIG. 13

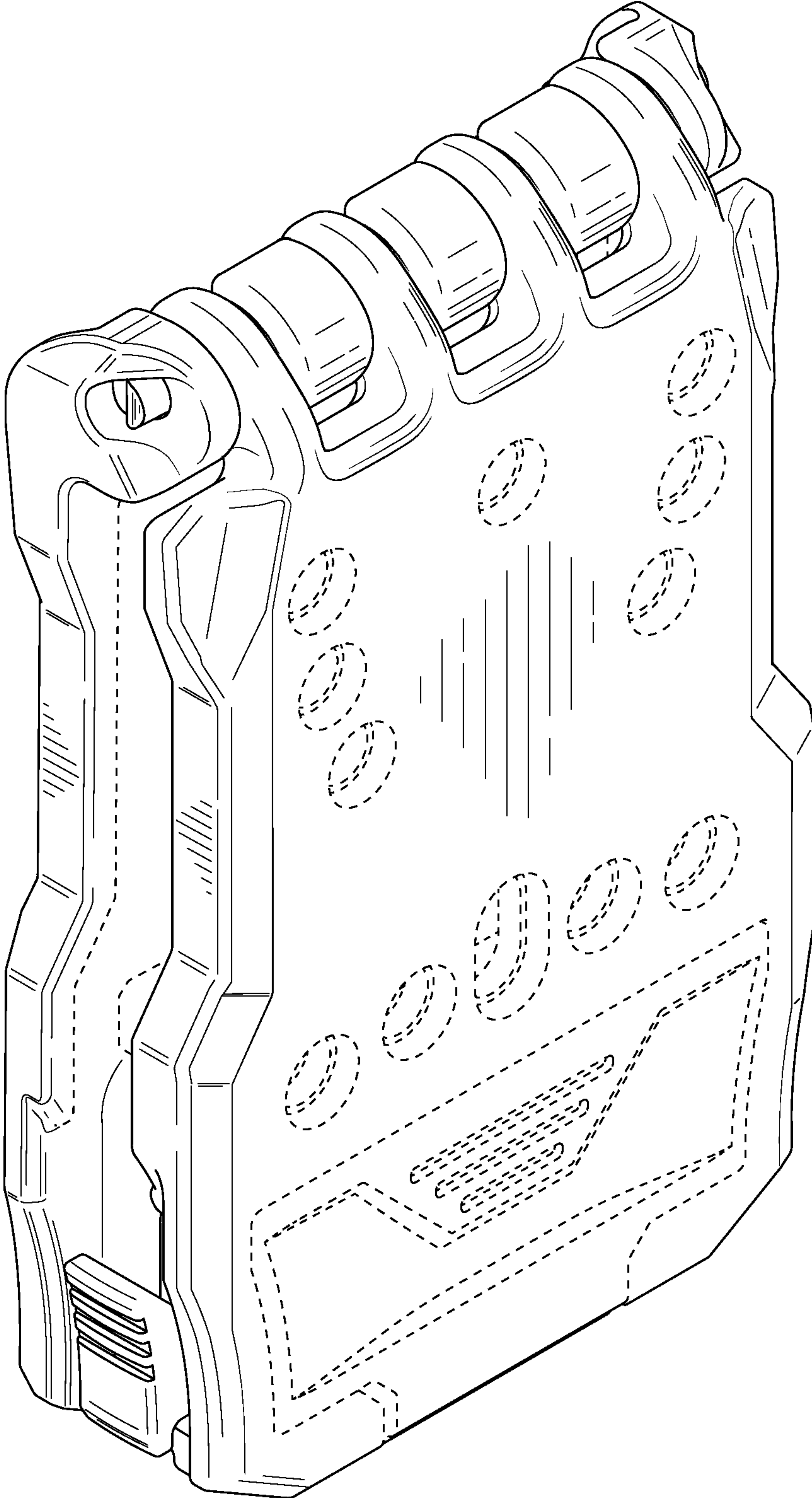

FIG. 14

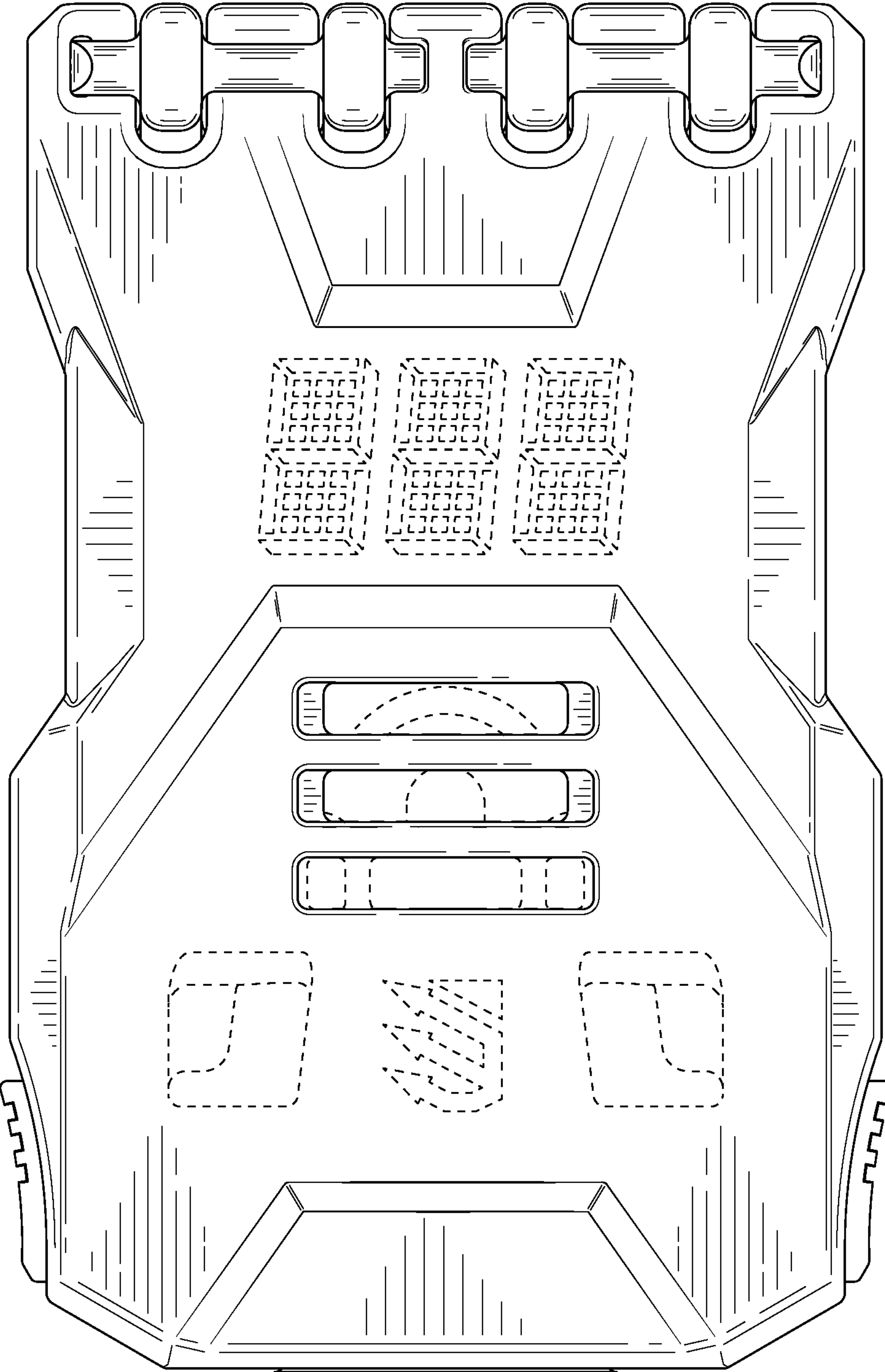

FIG. 15

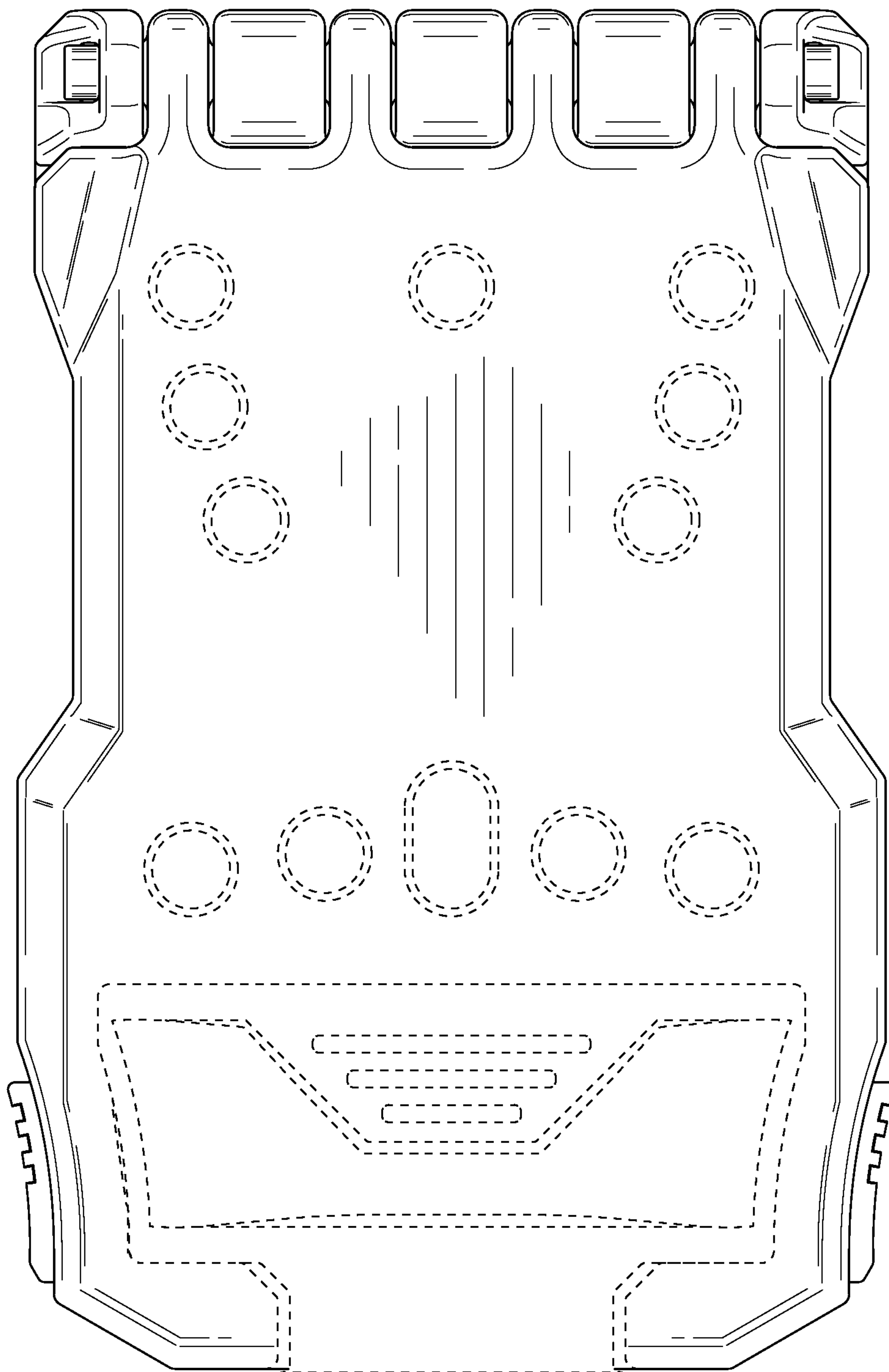

FIG. 16

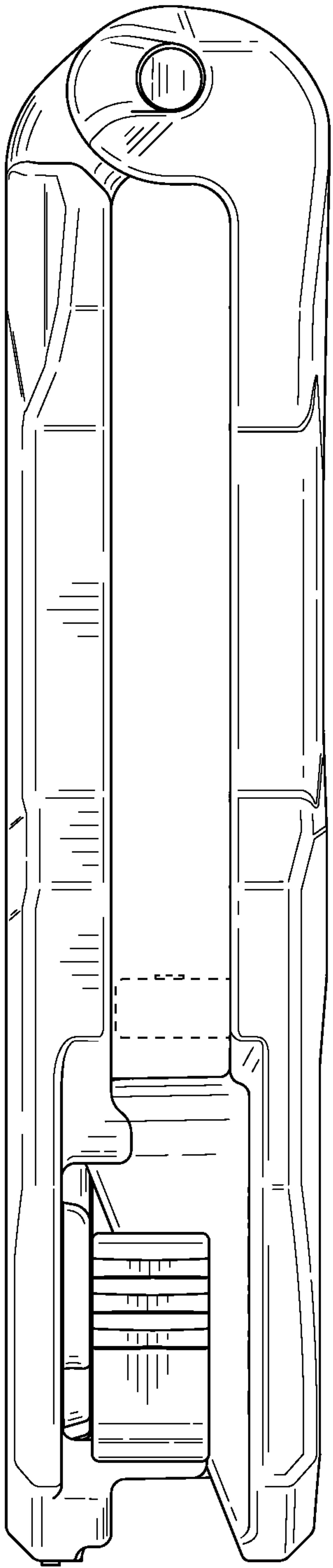

FIG. 17

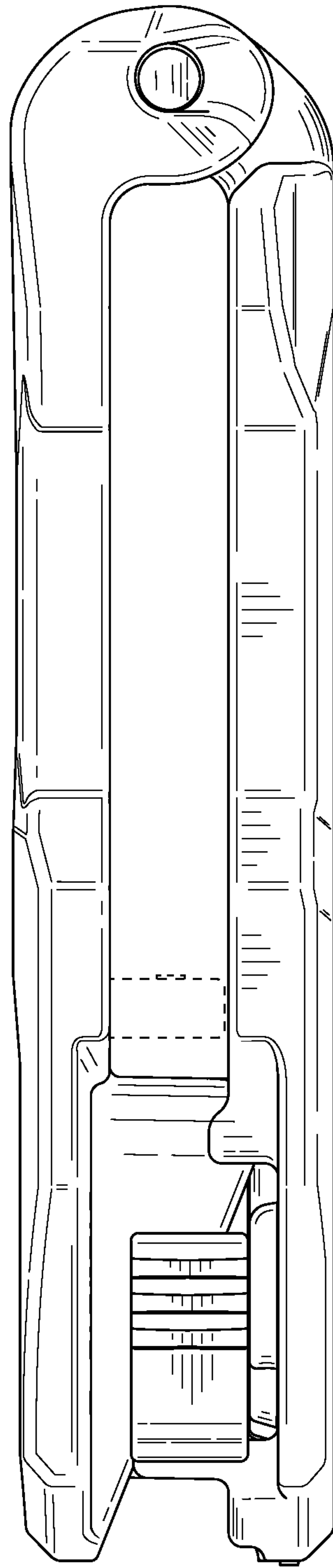

FIG. 18

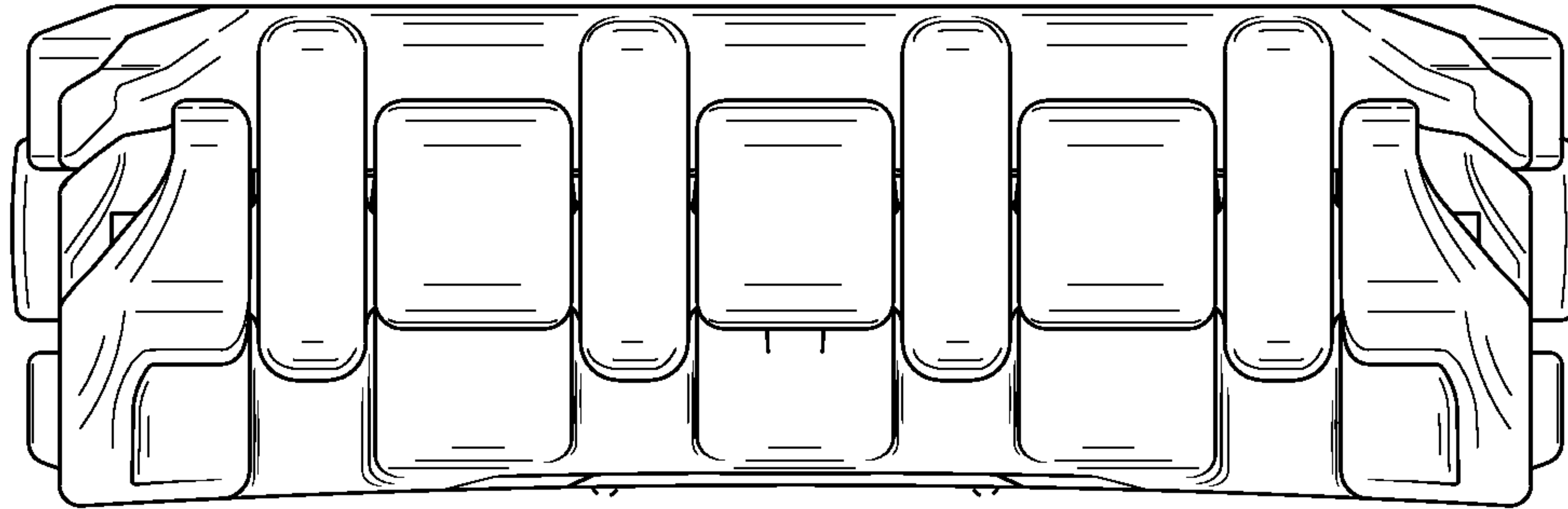

FIG. 19

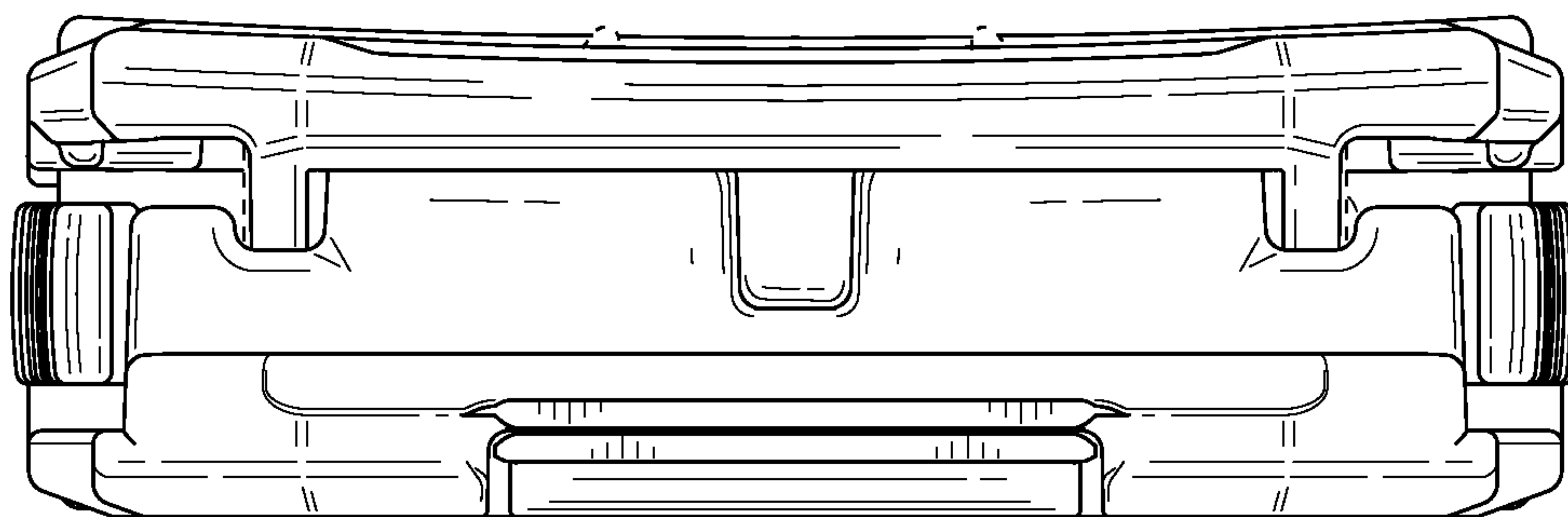

FIG. 20