



US00D945261S

(12) **United States Design Patent**
Marotti et al.

(10) **Patent No.:** **US D945,261 S**
(45) **Date of Patent:** **** Mar. 8, 2022**

(54) **TOOTHPASTE CARTON**

- (71) Applicant: **The Procter & Gamble Company**, Cincinnati, OH (US)
- (72) Inventors: **Martin Jay Marotti**, Carmel, IN (US); **Jennifer Kay Seiser**, Cincinnati, OH (US); **Eric Donald Weller**, Liberty Township, OH (US); **Geraldine Uribe**, Mason, OH (US)
- (73) Assignee: **The Procter & Gamble Company**, Cincinnati, OH (US)
- (**) Term: **15 Years**
- (21) Appl. No.: **29/771,562**
- (22) Filed: **Feb. 24, 2021**

Related U.S. Application Data

- (62) Division of application No. 29/717,335, filed on Dec. 17, 2019, now Pat. No. Des. 923,471.
- (51) **LOC (13) Cl.** **09-03**
- (52) **U.S. Cl.**
USPC **D9/432**
- (58) **Field of Classification Search**
USPC D7/601, 602, 609, 703; D9/414, 415, D9/416, 418, 423, 432, 433, 669, 713; D5/56, 59, 60, 62; D19/5; D20/11
(Continued)

(56) **References Cited**

U.S. PATENT DOCUMENTS

- D216,871 S * 3/1970 Leis D9/418
 - D275,837 S * 10/1984 Poelvoorde D9/418
- (Continued)

FOREIGN PATENT DOCUMENTS

- RU 00087183 12/2013
 - WO D208728-008 * 6/2020
- (Continued)

OTHER PUBLICATIONS

“Amazon Crest Gum Repair Toothpaste: Announced Oct. 6, 2019, online]. Site Visited [Dec. 17, 2020, online], Available from Internet URL: <https://www.amazon.com/Crest-Enamel-Toothpaste-Advanced-Whitening/dp/B07K11XWXY> (see wayback machine for date) (Year: 2019)”.

(Continued)

Primary Examiner — Catherine S Posthauer

(74) *Attorney, Agent, or Firm* — Parker D. McCrary

(57) **CLAIM**

The ornamental design for a toothpaste carton, as shown and described.

DESCRIPTION

The file of this patent contains at least one drawing/photograph executed in color. Copies of this patent with color drawing(s)/photograph(s) will be provided by the Office upon request and payment of the necessary fee.

FIG. 1 is a top, front, right perspective view of a first embodiment of a toothpaste carton;
 FIG. 2 is a front view thereof;
 FIG. 3 is a right side view thereof;
 FIG. 4 is a back view thereof;
 FIG. 5 is a left side view thereof;
 FIG. 6 is a top view thereof; and
 FIG. 7 is a bottom view thereof.
 FIG. 8 is a top, front, right perspective view of a second embodiment of a toothpaste carton;
 FIG. 9 is a front view thereof;
 FIG. 10 is a right side view thereof;
 FIG. 11 is a back view thereof;
 FIG. 12 is a left side view thereof;
 FIG. 13 is a top view thereof; and
 FIG. 14 is a bottom view thereof.
 FIG. 15 is a top, front, right perspective view of a third embodiment of a toothpaste carton;
 FIG. 16 is a front view thereof;
 FIG. 17 is a right side view thereof;
 FIG. 18 is a back view thereof;
 FIG. 19 is a left side view thereof;

(Continued)

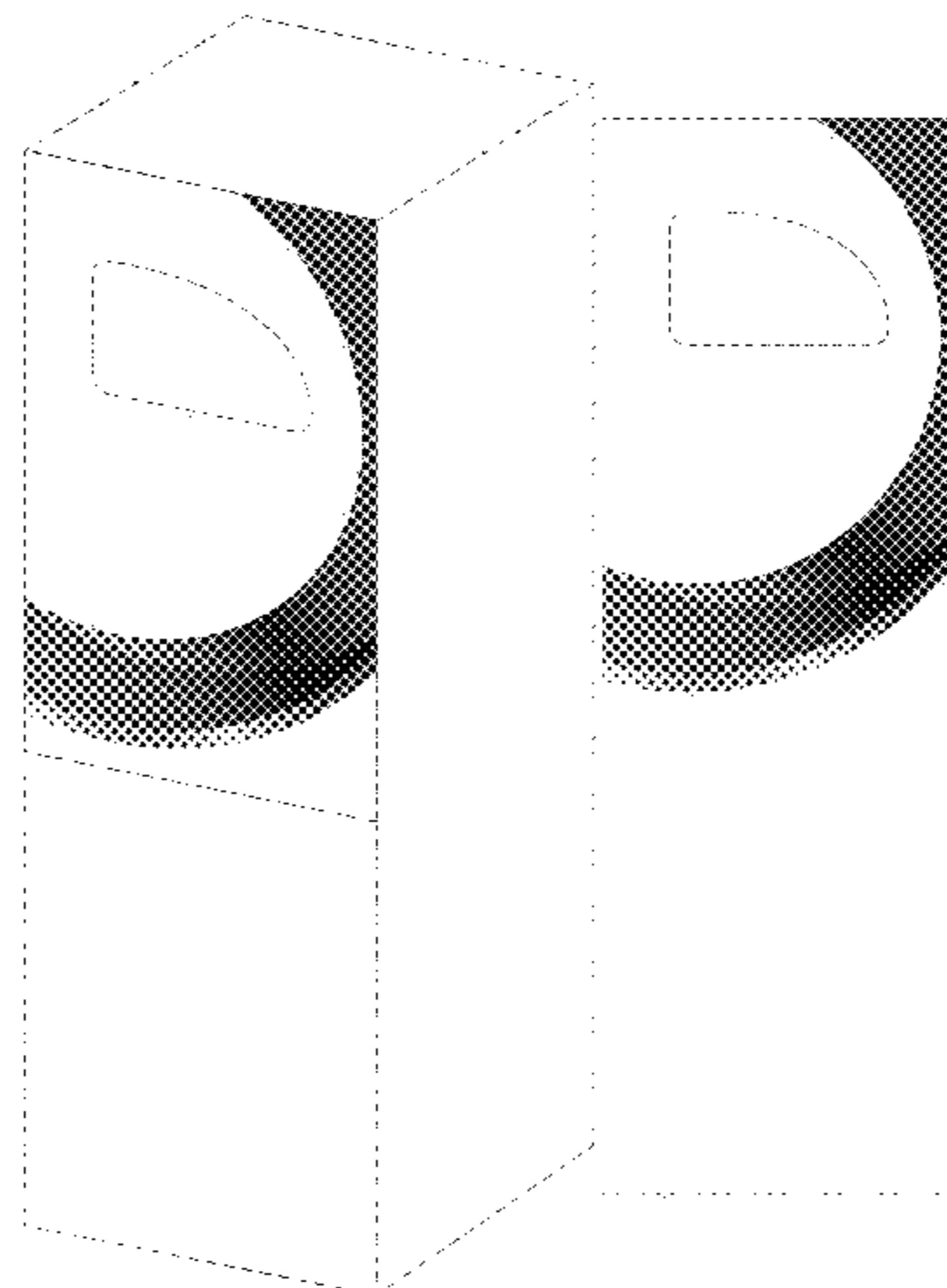

FIG. 20 is a top view thereof; and
 FIG. 21 is a bottom view thereof.
 FIG. 22 is a top, front, right perspective view of a fourth embodiment of a toothpaste carton;
 FIG. 23 is a front view thereof;
 FIG. 24 is a right side view thereof;
 FIG. 25 is a back view thereof;
 FIG. 26 is a left side view thereof;
 FIG. 27 is a top view thereof; and,
 FIG. 28 is a bottom view thereof.
 The broken lines are shown for the purpose of illustrating parts of the article that form no part of the claim. The dot-dash lines represent the boundaries of the claim and form no part thereof.

**1 Claim, 16 Drawing Sheets
 (4 of 16 Drawing Sheet(s) Filed in Color)**

(58) Field of Classification Search

CPC B65D 35/34; B65D 75/32; B65D 77/24;
 B65D 5/00; B65D 1/00; B65D 2203/00;
 B65D 2203/02; B65D 65/22

See application file for complete search history.

(56) References Cited

U.S. PATENT DOCUMENTS

D499,019	S	*	11/2004	Sagmeister	D9/418
D586,210	S	*	2/2009	Noschang	D9/434
D595,129	S	*	6/2009	Russell	D9/432
D629,044	S	*	12/2010	Suyama	D20/28
D637,486	S	*	5/2011	Andrew	D9/432
D649,874	S	*	12/2011	Barclay	D9/432
D660,145	S	*	5/2012	Tekulve	D9/432
D669,793	S	*	10/2012	Hynes	D9/702

D693,681	S	*	11/2013	Allen	D9/434
D701,760	S	*	4/2014	Fraser	D9/434
D706,630	S	*	6/2014	Merchant	D9/434
D711,737	S	*	8/2014	Hara	D9/432
D750,899	S	*	3/2016	Duparc	D5/27
D750,900	S	*	3/2016	Duparc	D5/27
D762,465	S	*	8/2016	Popper	D9/415
D767,398	S	*	9/2016	Miyazaki	D9/499
D784,455	S	*	4/2017	Sims	D20/22
D786,680	S	*	5/2017	Merchant	D9/516
D791,594	S	*	7/2017	Klarin	D9/516
D798,703	S	*	10/2017	Hainaut	D9/418
D821,199	S	*	6/2018	Boston	D9/499
D822,480	S	*	7/2018	Rivera	D9/418
D822,481	S	*	7/2018	Rivera	D9/418
D829,105	S	*	9/2018	Templeman	D9/629
D833,868	S	*	11/2018	Marotti	D9/434
D842,101	S	*	3/2019	Breen	D9/434
D842,102	S	*	3/2019	Janes	D9/434
D842,692	S	*	3/2019	Breen	D9/434
D842,693	S	*	3/2019	Janes	D9/434
D842,694	S	*	3/2019	Janes	D9/434
D852,820	S	*	7/2019	Sanchez	D14/485
D854,551	S	*	7/2019	Pistiner	D14/485
D855,452	S	*	8/2019	Palacios	D9/418
D870,551	S	*	12/2019	Klesmith	D9/418
D871,210	S	*	12/2019	Clifton	D9/432
D880,293	S	*	4/2020	Redding	D9/432

FOREIGN PATENT DOCUMENTS

WO	D208728-009	*	6/2020
WO	D208728-010	*	6/2020
WO	D208728-006		12/2020

OTHER PUBLICATIONS

“All Office Actions, U.S. Appl. No. 29/717,335”.
 “All Office Actions, U.S. Appl. No. 29/771,561”.

* cited by examiner

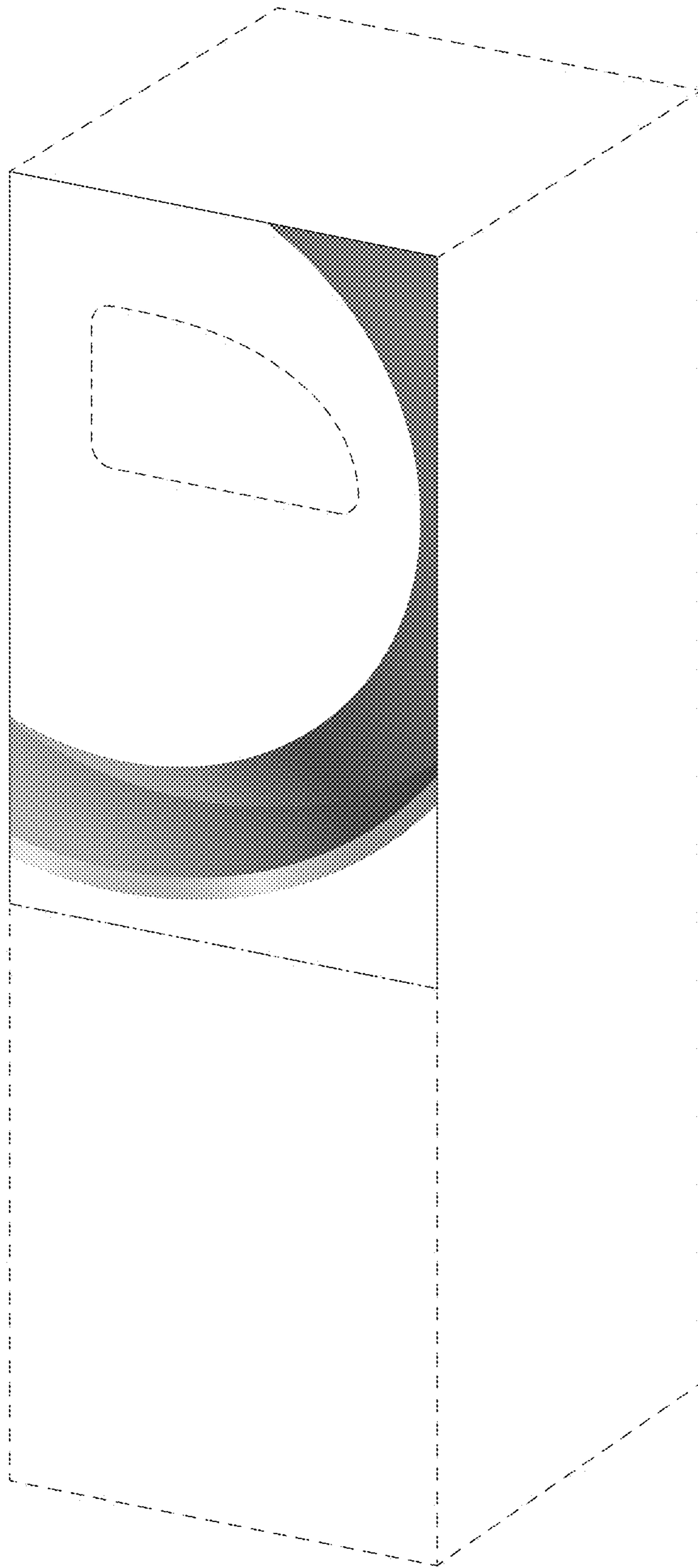

FIG. 1

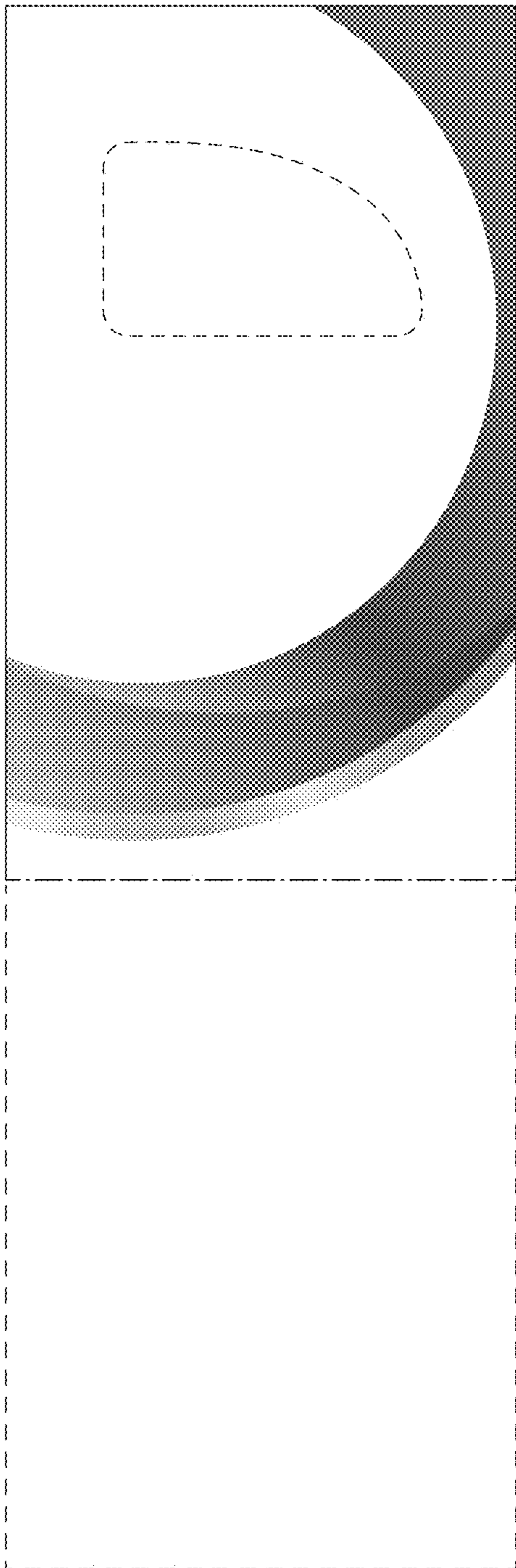

FIG. 2

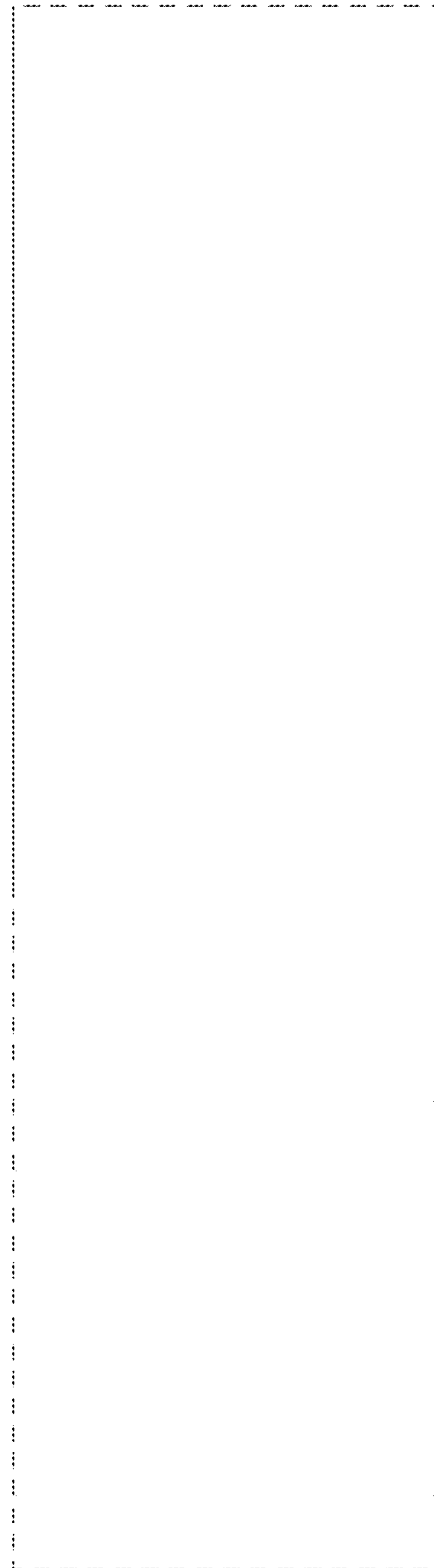

FIG. 3

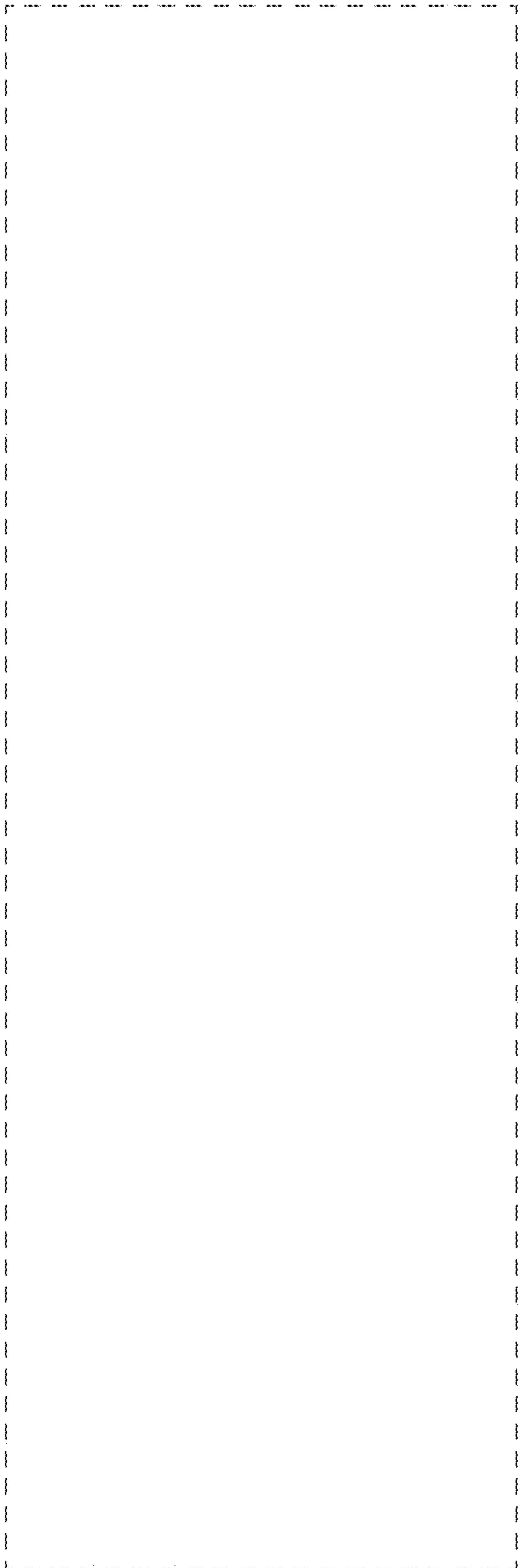

FIG. 4

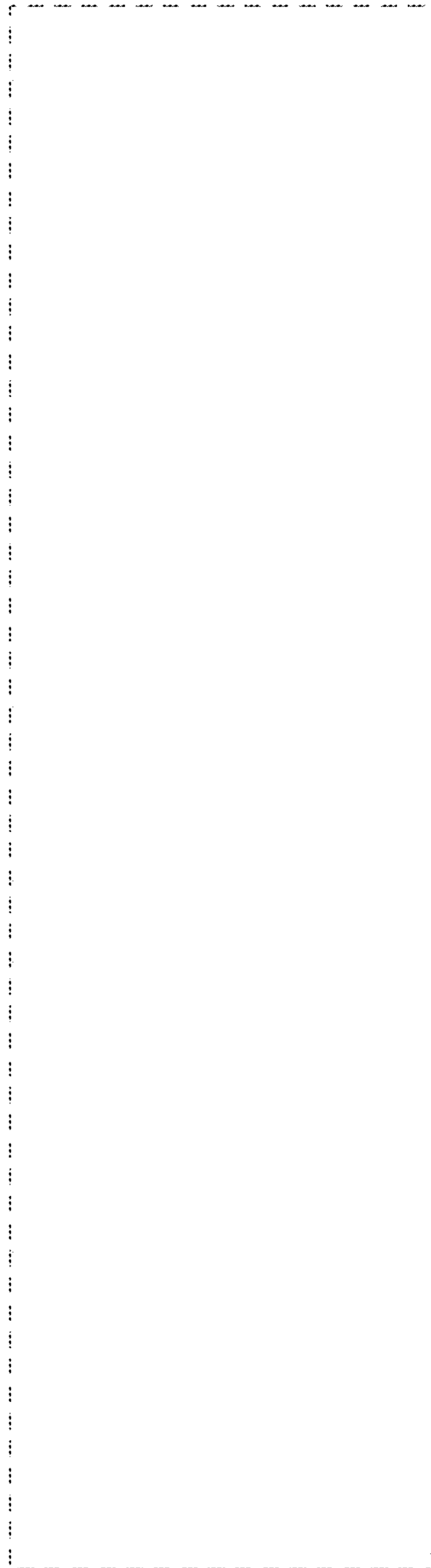

FIG. 5

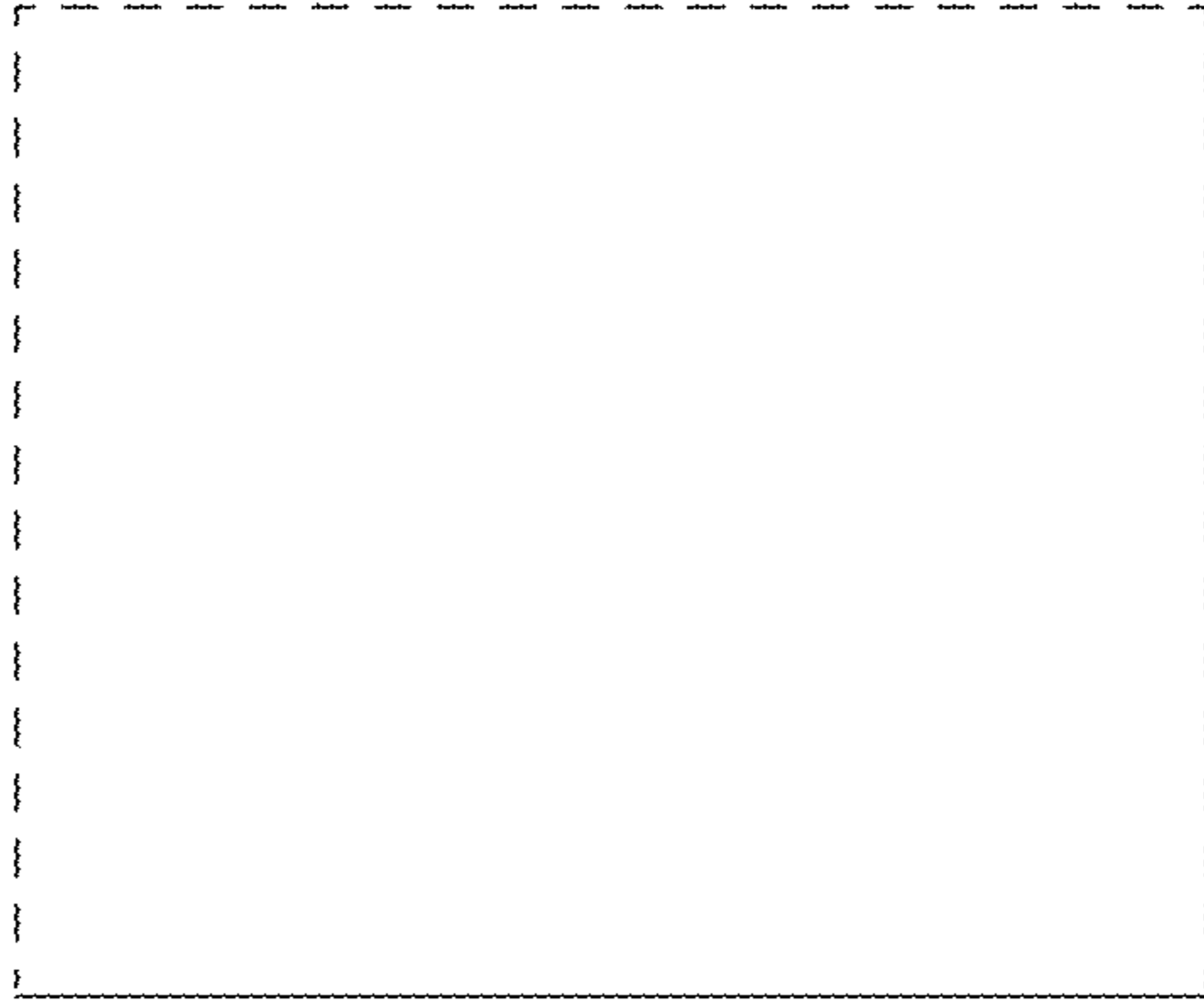

FIG. 6

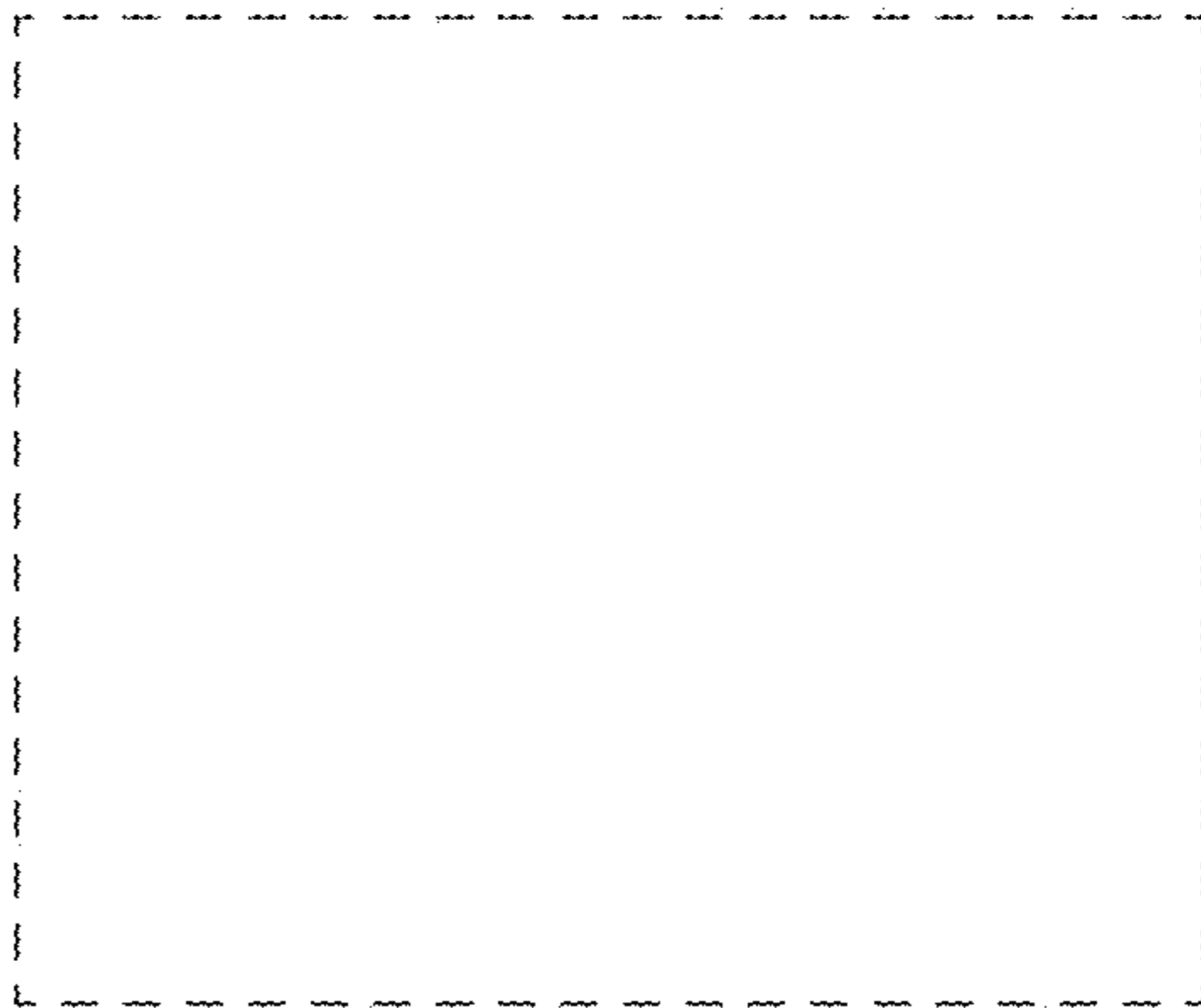

FIG. 7

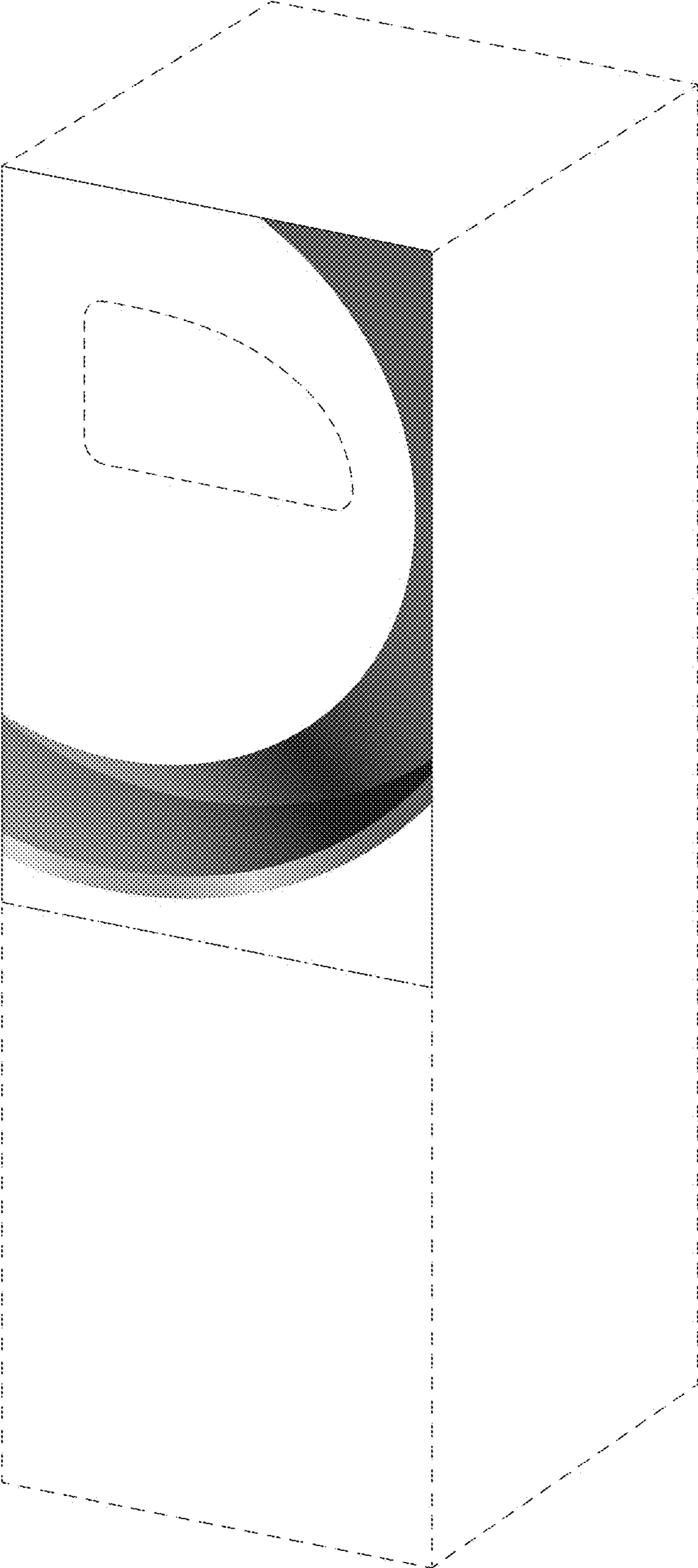

FIG. 8

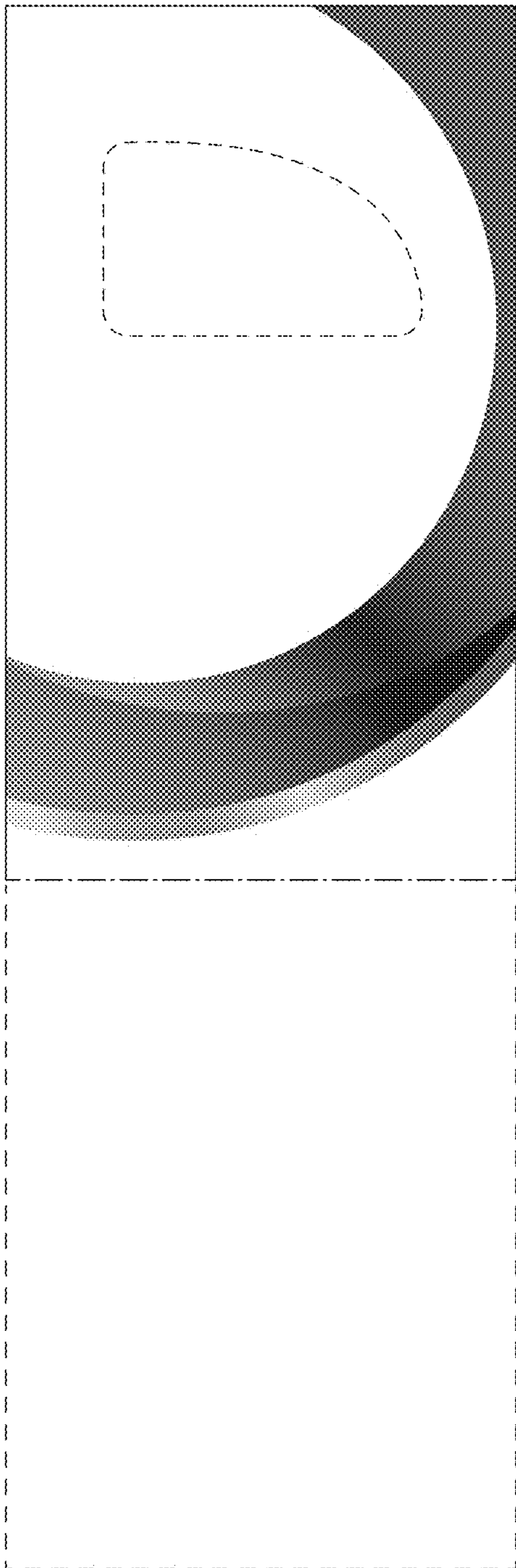

FIG. 9

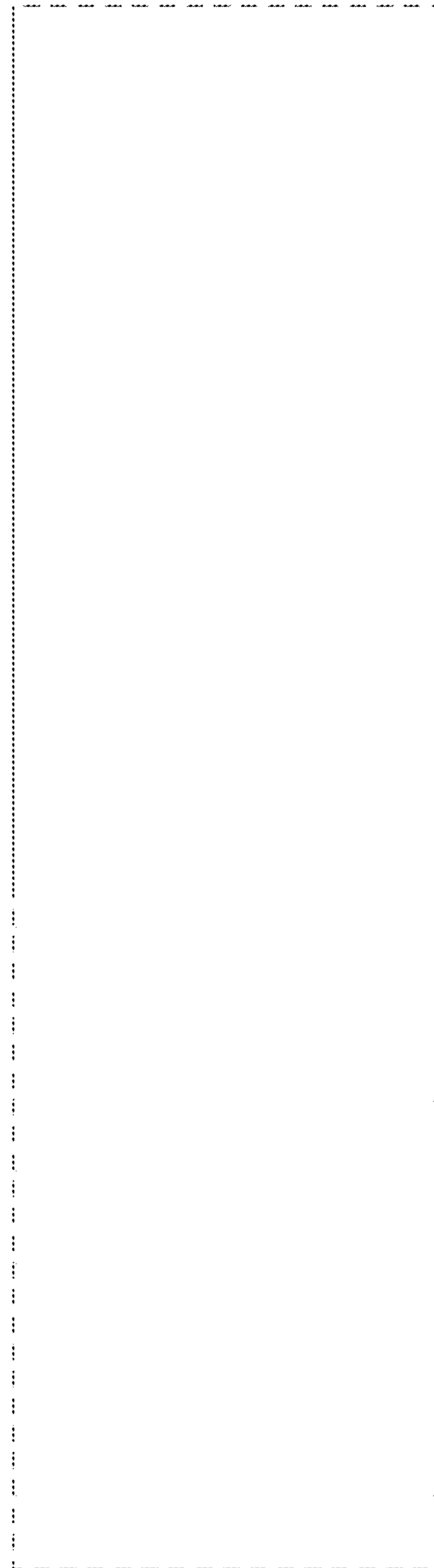

FIG. 10

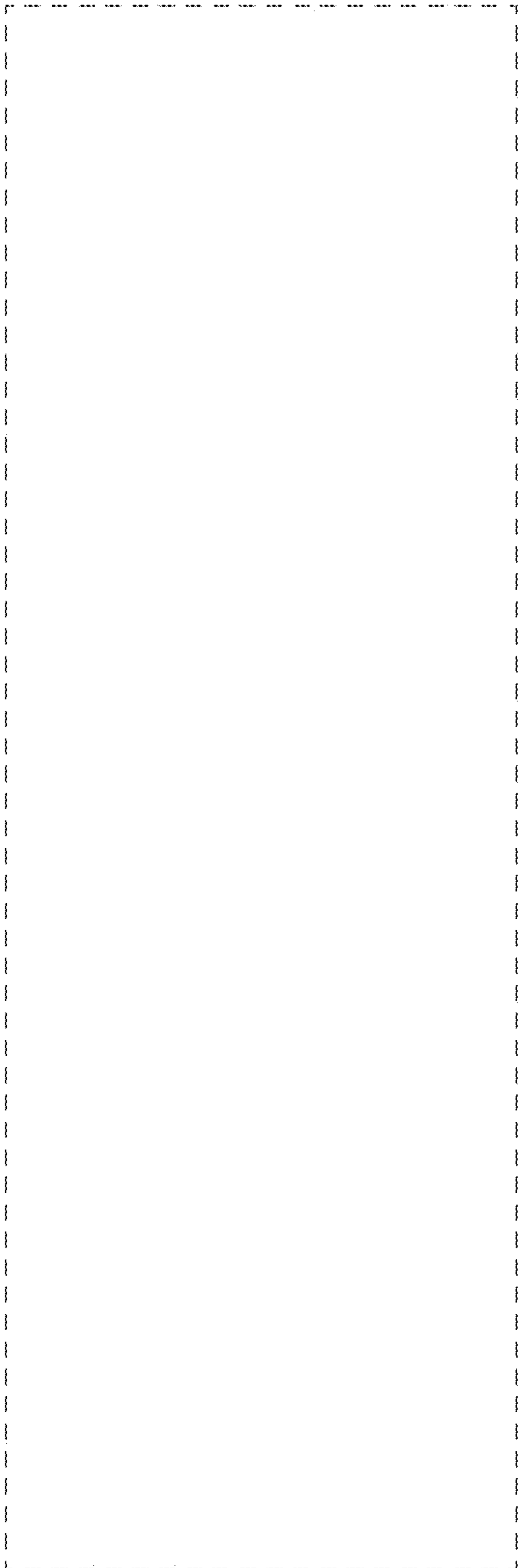

FIG. 11



FIG. 12

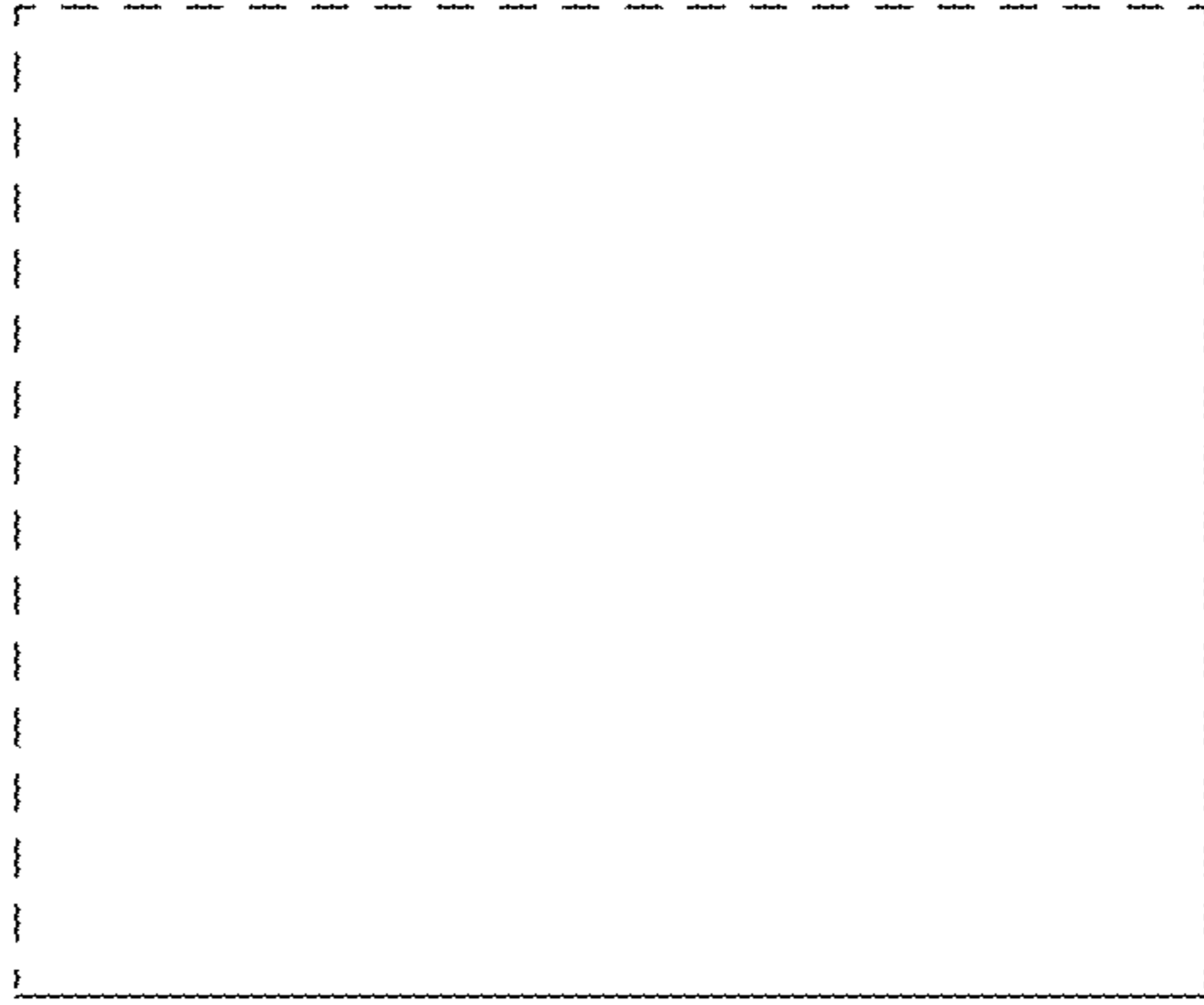

FIG. 13



FIG. 14

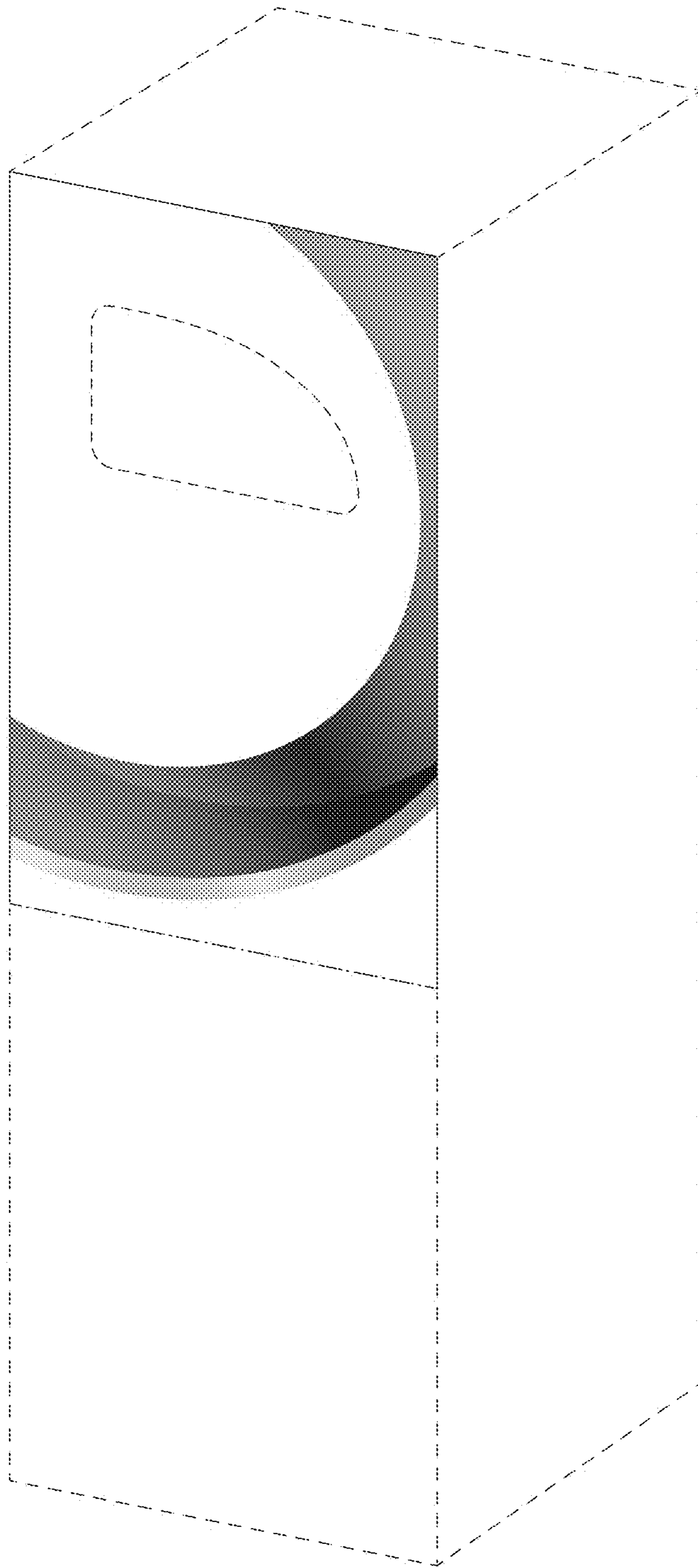

FIG. 15

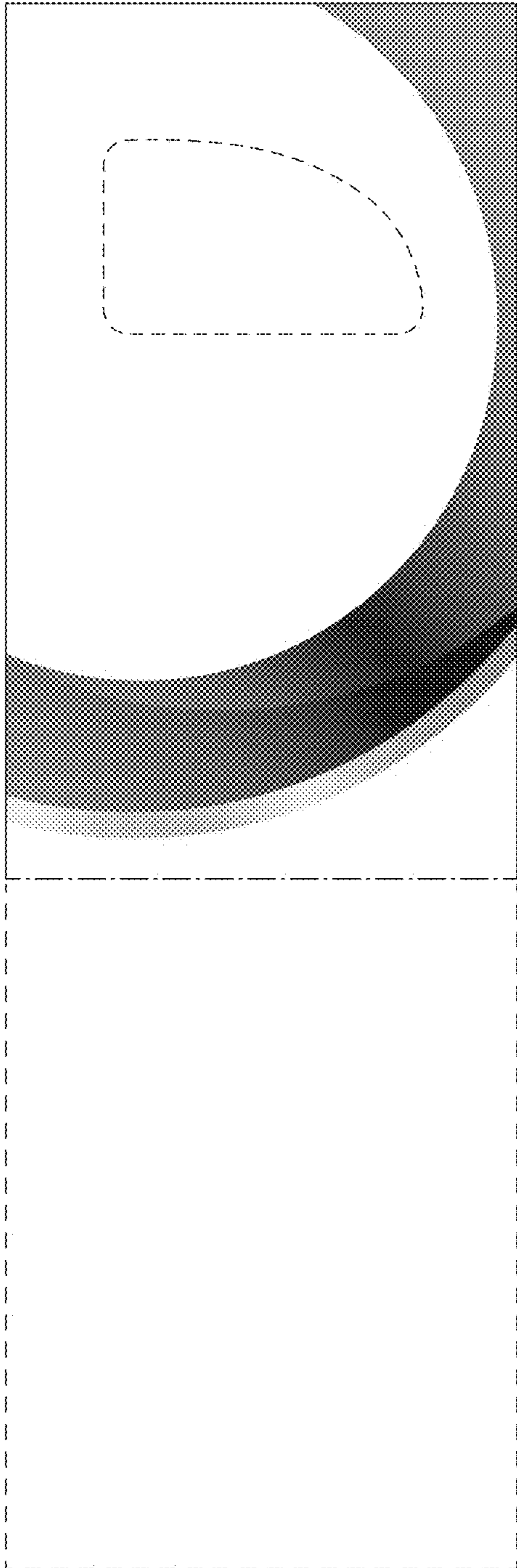

FIG. 16

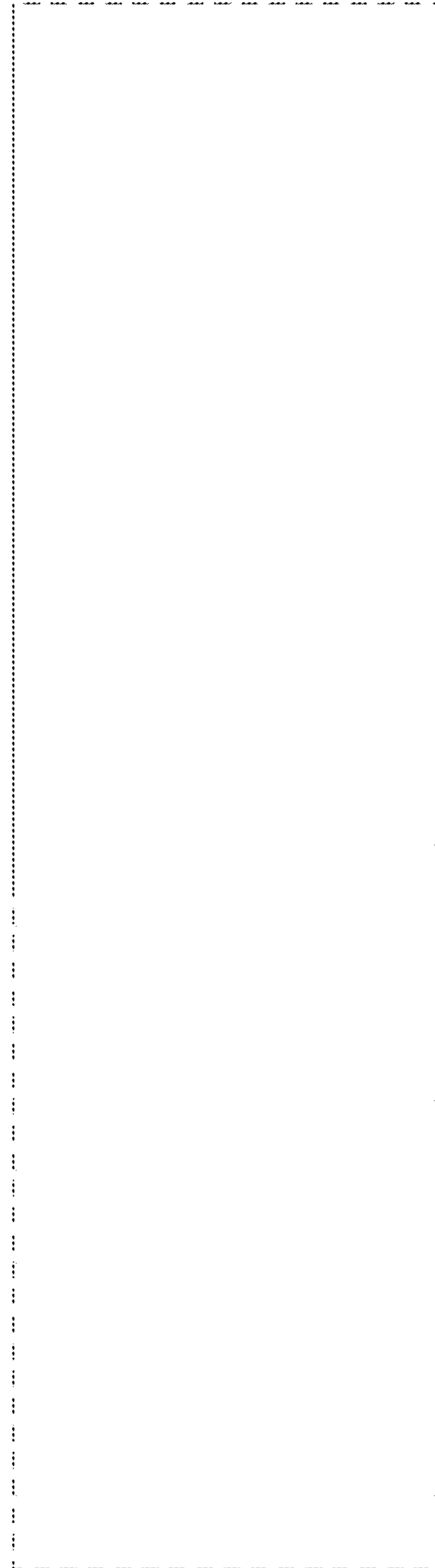

FIG. 17

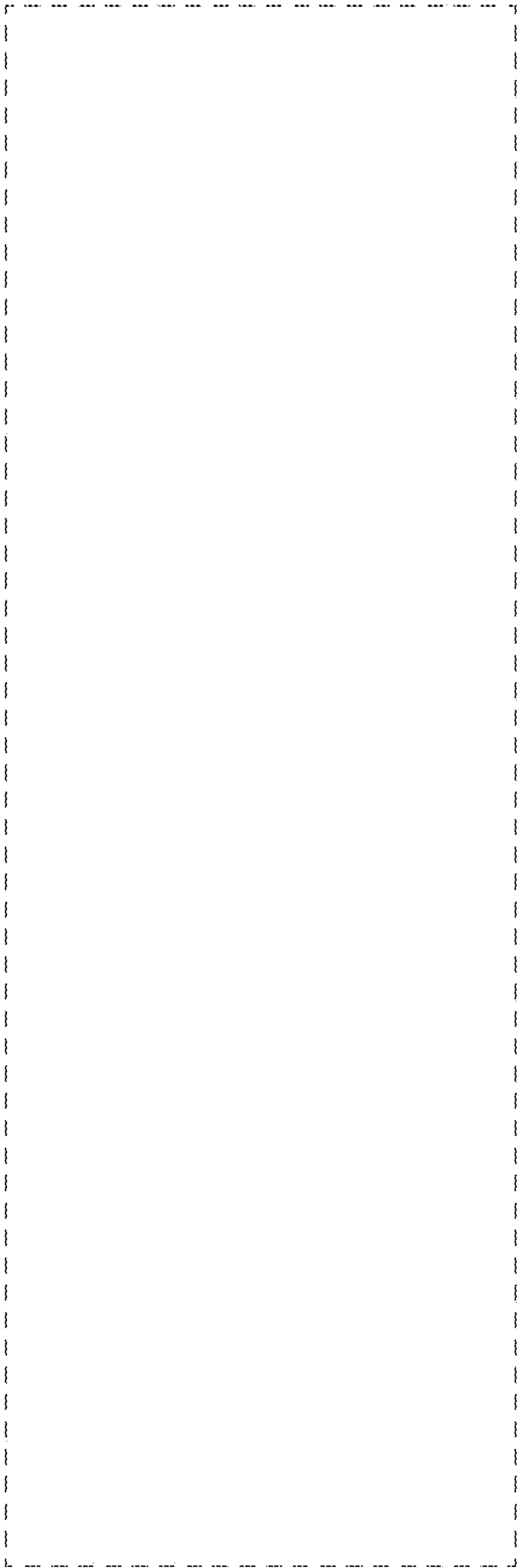

FIG. 18



FIG. 19

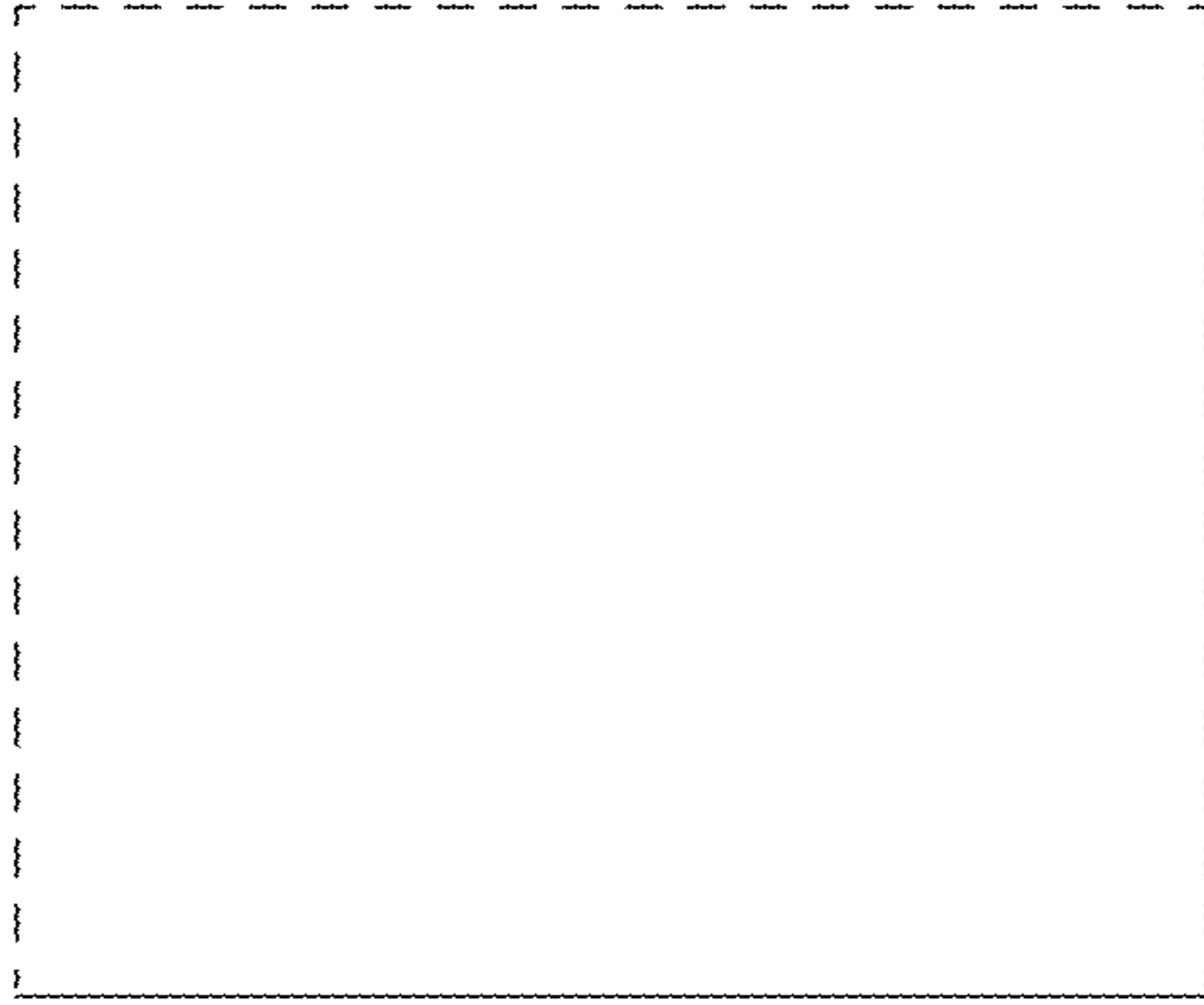

FIG. 20



FIG. 21

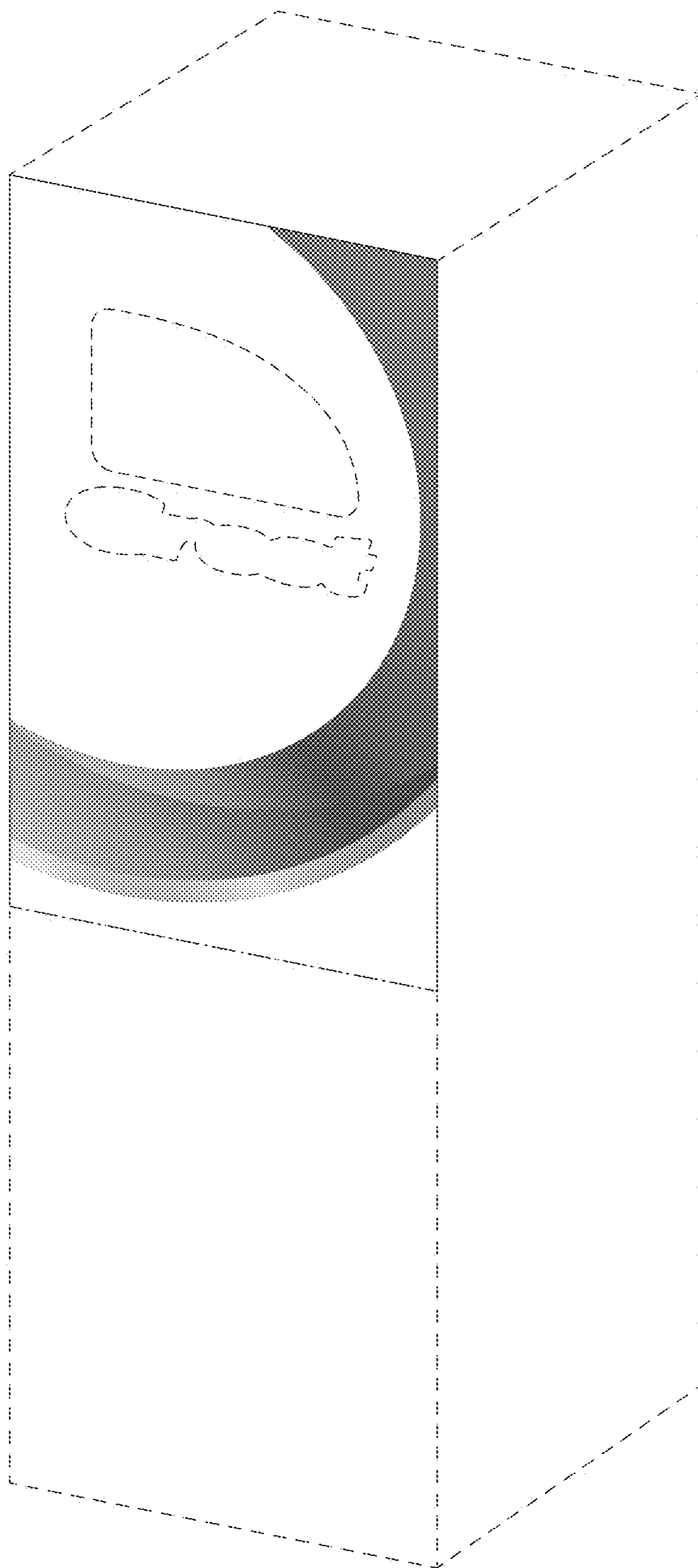

FIG. 22

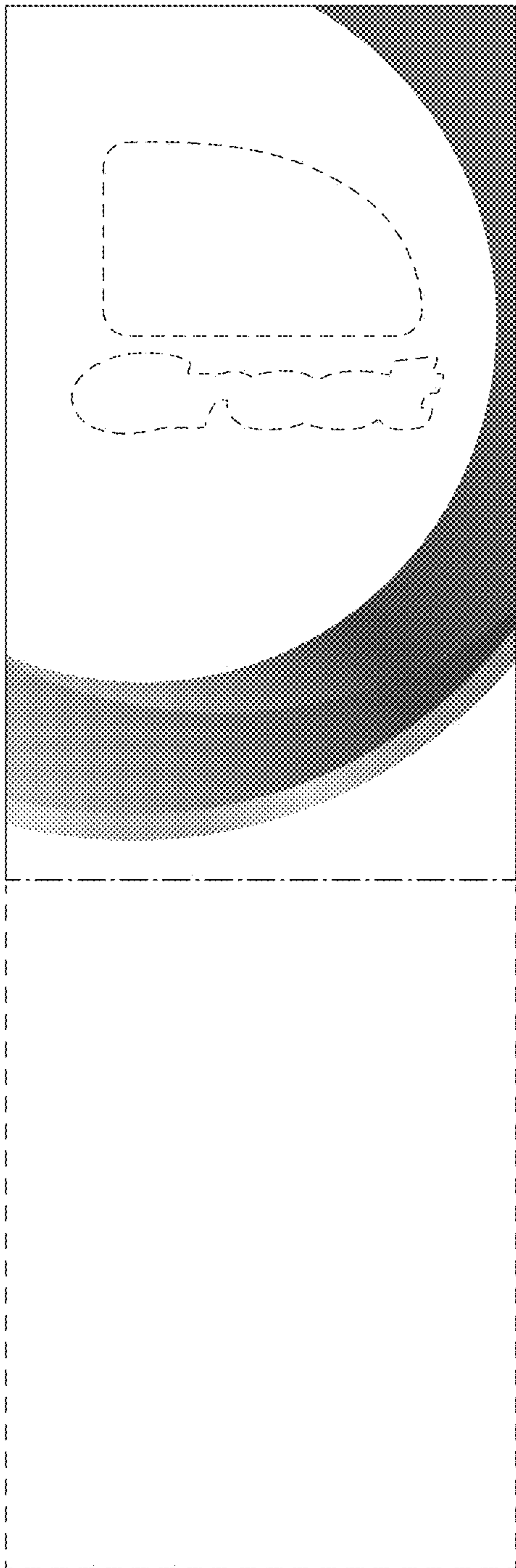

FIG. 23

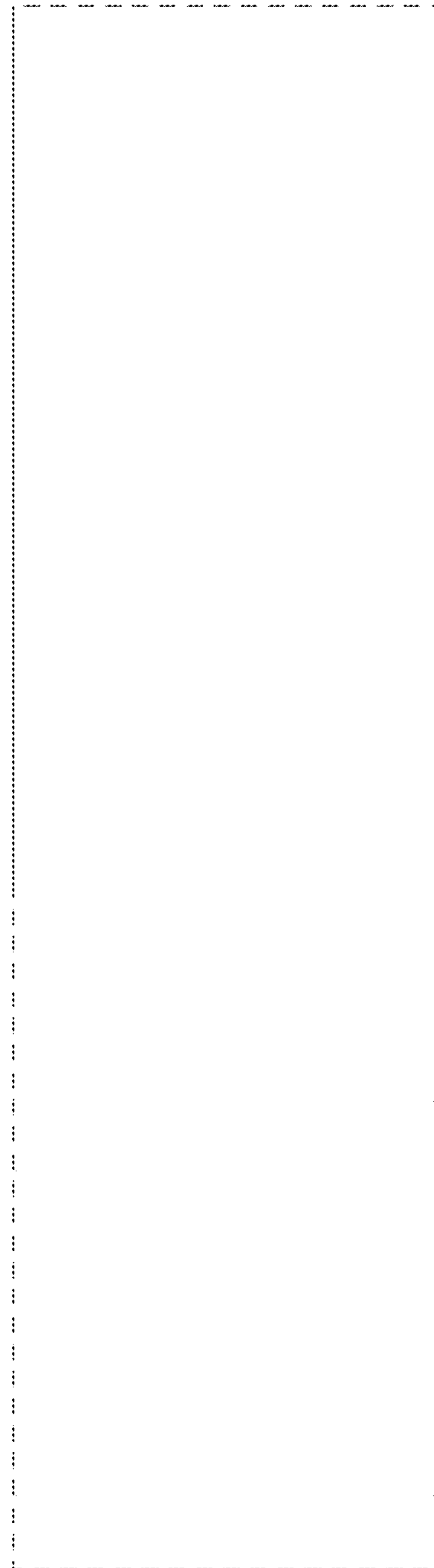

FIG. 24

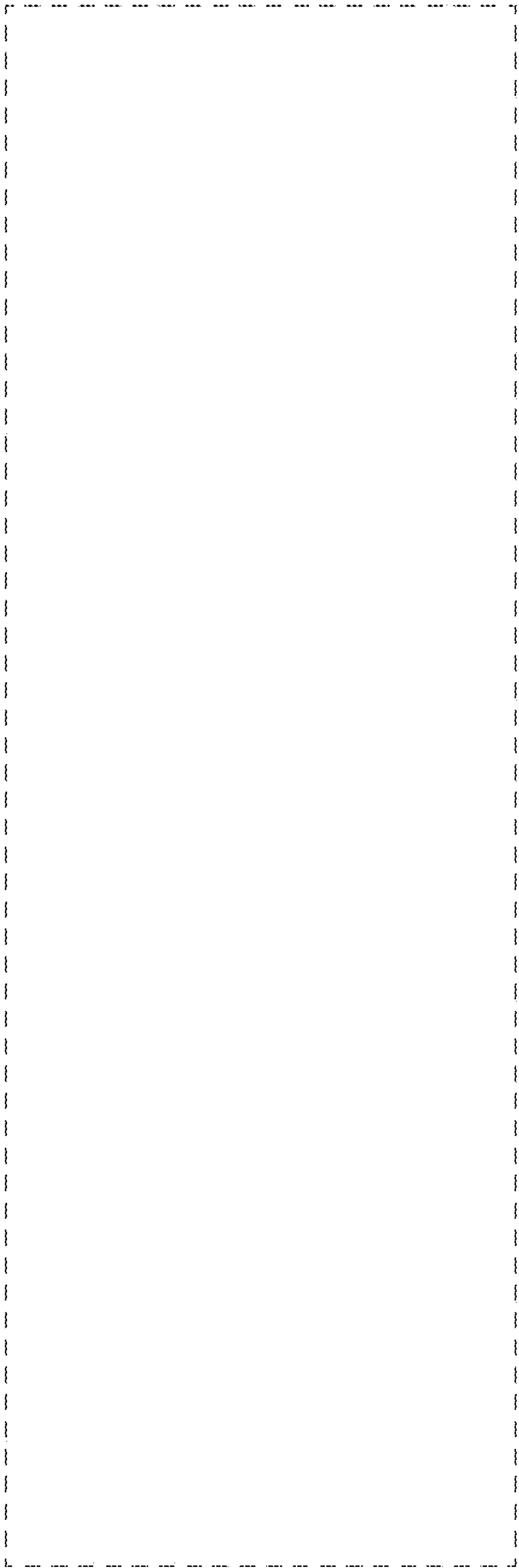

FIG. 25



FIG. 26

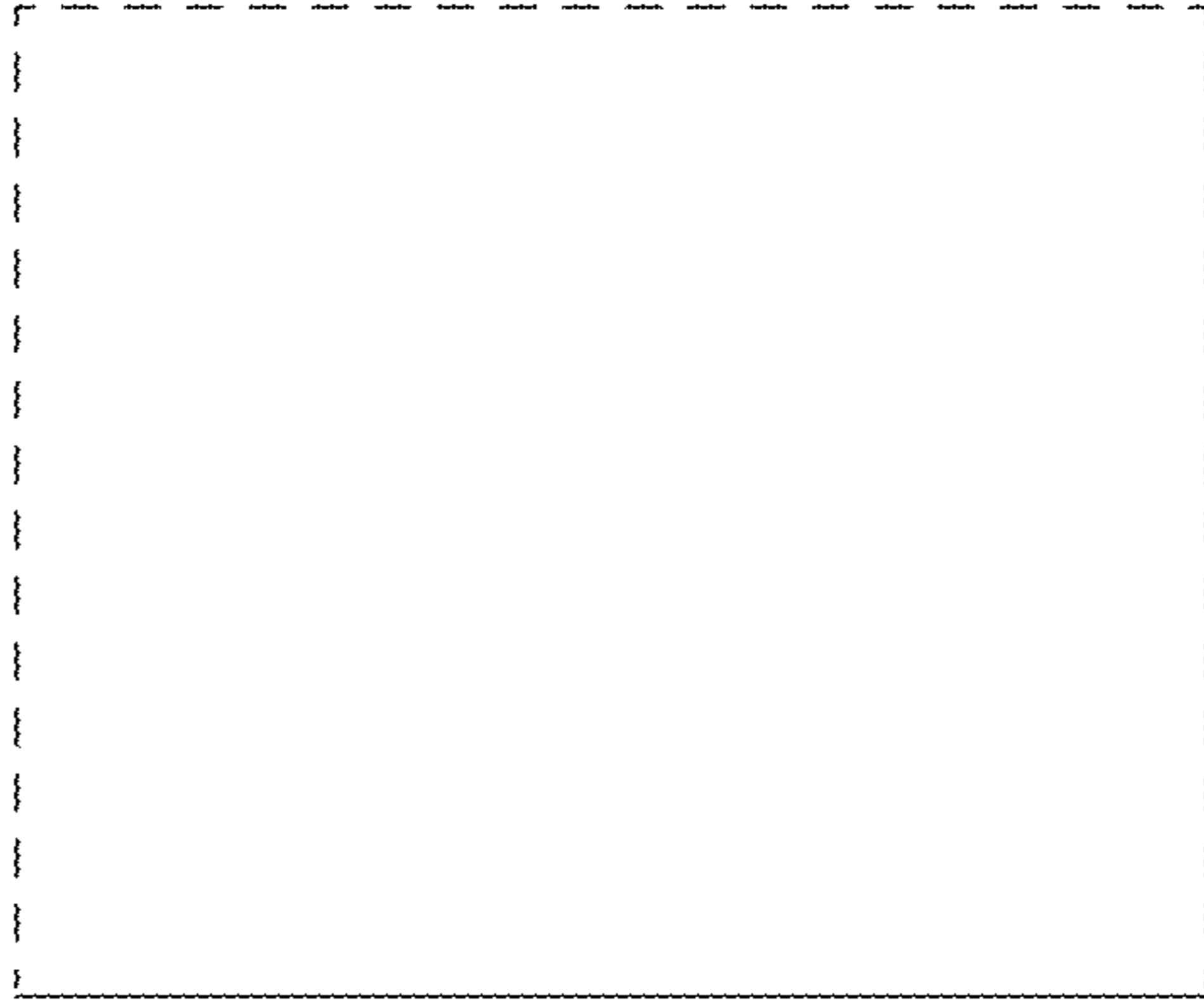

FIG. 27



FIG. 28