

US00D945257S

(12) **United States Design Patent** (10) **Patent No.:** **US D945,257 S**
Boon et al. (45) **Date of Patent:** **** Mar. 8, 2022**

(54) **PRODUCT PACKAGING**

(71) Applicant: **Kimberly-Clark Worldwide, Inc.**,
Neenah, WI (US)
(72) Inventors: **Jason R. Boon**, Appleton, WI (US);
Paige E. Chapman, Neenah, WI (US);
Benjamin Greengrass, New York, NY
(US); **Christopher R. Reynolds**,
Chicago, IL (US)
(73) Assignee: **Kimberly-Clark Worldwide, Inc.**,
Neenah, WI (US)

(**) Term: **15 Years**

(21) Appl. No.: **29/700,255**

(22) Filed: **Jul. 31, 2019**

(51) **LOC (13) Cl.** **09-03**

(52) **U.S. Cl.**
USPC **D9/414; D9/434**

(58) **Field of Classification Search**
USPC D5/5, 27, 30, 63, 64, 99; D1/100–130,
D1/199; D7/387, 388, 389, 396.4;
D9/414, 415, 416, 418, 419, 430, 432,
D9/433, 434, 456, 457, 600, 623, 643,
D9/715, 544, 545, 603, 629, 702–714,
D9/731, 662; D2/853, 857, 508;
D20/10, 11, 13, 19, 22, 27, 40; D24/100,
D24/121, 224; D18/24, 25, 26, 27, 28,
D18/29, 30, 31, 32
CPC B65D 21/0205; B65D 77/0426; B65D
71/10; B65D 5/00; B65D 5/001; B65D
5/02; B65D 5/0015; B65D 5/0227–0254;
B65D 5/18; B65D 5/20; B65D 5/38;
B65D 5/40; B65D 5/2033; B65D
5/40024; B65D 5/6605; B65D 1/22;
B65D 1/24; B65D 1/34; B63B 35/38;
B63B 35/00; A23G 3/50; A23G 3/563;
A23G 9/503; A23G 9/26; A23G 9/48

See application file for complete search history.

(56) **References Cited**

U.S. PATENT DOCUMENTS

D110,342 S * 7/1938 Chernow D18/24
D139,156 S * 10/1944 Stone D18/24
D151,736 S * 11/1948 Chernow D18/28
3,420,367 A * 1/1969 Carmichael B65D 71/08
206/432
3,460,671 A * 8/1969 Harm B65D 71/08
206/391
5,685,428 A * 11/1997 Herbers B65D 71/0085
206/391

(Continued)

OTHER PUBLICATIONS

Viva Logo: Site Visited [Jan. 7, 2021]. Available from Internet URL:
<https://logodix.com/logos/563096>.*

(Continued)

Primary Examiner — Catherine S Posthauer
(74) *Attorney, Agent, or Firm* — Banner & Witcoff, Ltd.

(57) **CLAIM**

The ornamental design for a product packaging, as shown and described.

DESCRIPTION

FIG. 1 is a top, front, left perspective view of a product packaging showing our new design;
FIG. 2 is a front view thereof;
FIG. 3 is a rear view thereof;
FIG. 4 is a right side view thereof;
FIG. 5 is a left side view thereof;
FIG. 6 is a top view thereof; and,
FIG. 7 is a bottom view thereof.
The broken lines are shown for the purpose of illustrating parts of the product packaging that form no part of the claimed design. The surfaces demarcated by solid lines form no part of the claimed design.

1 Claim, 7 Drawing Sheets

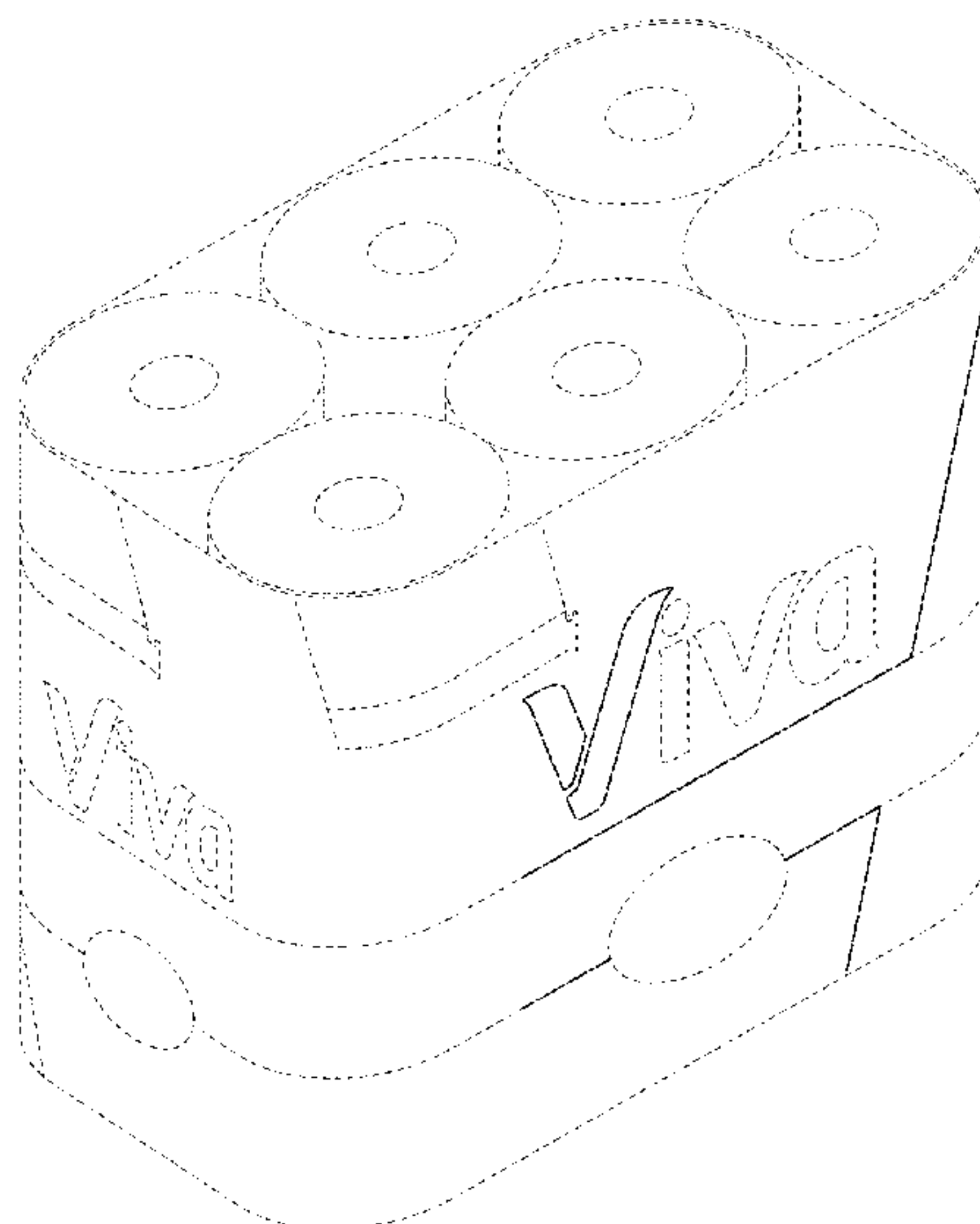

(56)

References Cited

U.S. PATENT DOCUMENTS

D499,887 S * 12/2004 Wong D5/53
 D574,721 S * 8/2008 Rillo D9/715
 D602,947 S * 10/2009 Arnell D14/489
 D612,260 S * 3/2010 Champion D9/600
 D613,304 S * 4/2010 Arnell D14/490
 D758,431 S * 6/2016 Kim D14/489
 D772,063 S * 11/2016 Thompson D9/434
 9,708,085 B2 * 7/2017 Moore B65D 85/07
 10,336,505 B2 * 7/2019 Moore B65D 5/46016
 D862,514 S * 10/2019 Laurino D14/489
 D867,393 S * 11/2019 Lee D14/489
 D882,277 S * 4/2020 Delaney D5/63
 2007/0084741 A1 * 4/2007 Dall’Omo B65D 75/52
 206/391
 2008/0078685 A1 * 4/2008 Patterson B65D 5/4204
 206/391
 2008/0202964 A1 * 8/2008 Knobloch B65D 71/00
 206/394

OTHER PUBLICATIONS

Viva Paper Towels Logo: Announced [Dec. 18, 2019; Online]. Site Visited [Jan. 7, 2021]. Available from Internet URL: logovector.dl.com/viva-paper-towels-logo-vector-svg/.*

Viva Towels: Announced [Dec. 24, 2019; Online]. Site Visited [Jan. 7, 2021]. Available from Internet URL: <https://www.vivatowels.com/en-us/>.*

“Kimberly-Clark Viva Choose-A-Sheet Paper Towel”; ReStockIt; retrieved Jul. 25, 2019; disclosure date unknown but prior to the filing date of the present application; URL: <https://www.restockit.com/viva-choose-a-sheet-paper-towel-num-kcc49430.html?source=IDx20111014x00001g&utm_source=IDx20111014x00001g&utm_medium=paid&utm_campaign=gpla&gclid=EAlalQobChMlv7DfzjQ4wIVDxgMCh0zmQgUEAQYCiABEglvfvD_BwE>.

* cited by examiner

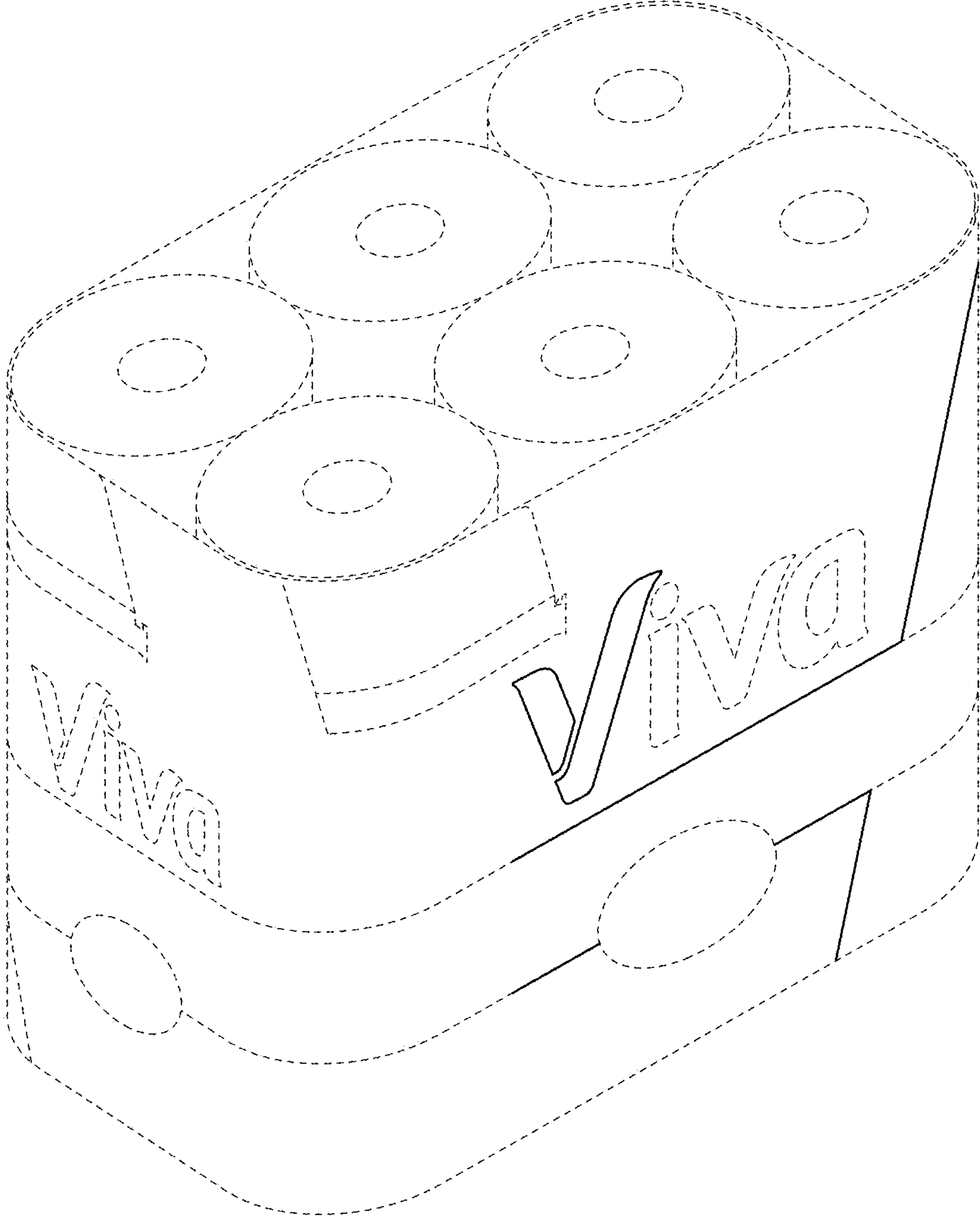

FIG. 1

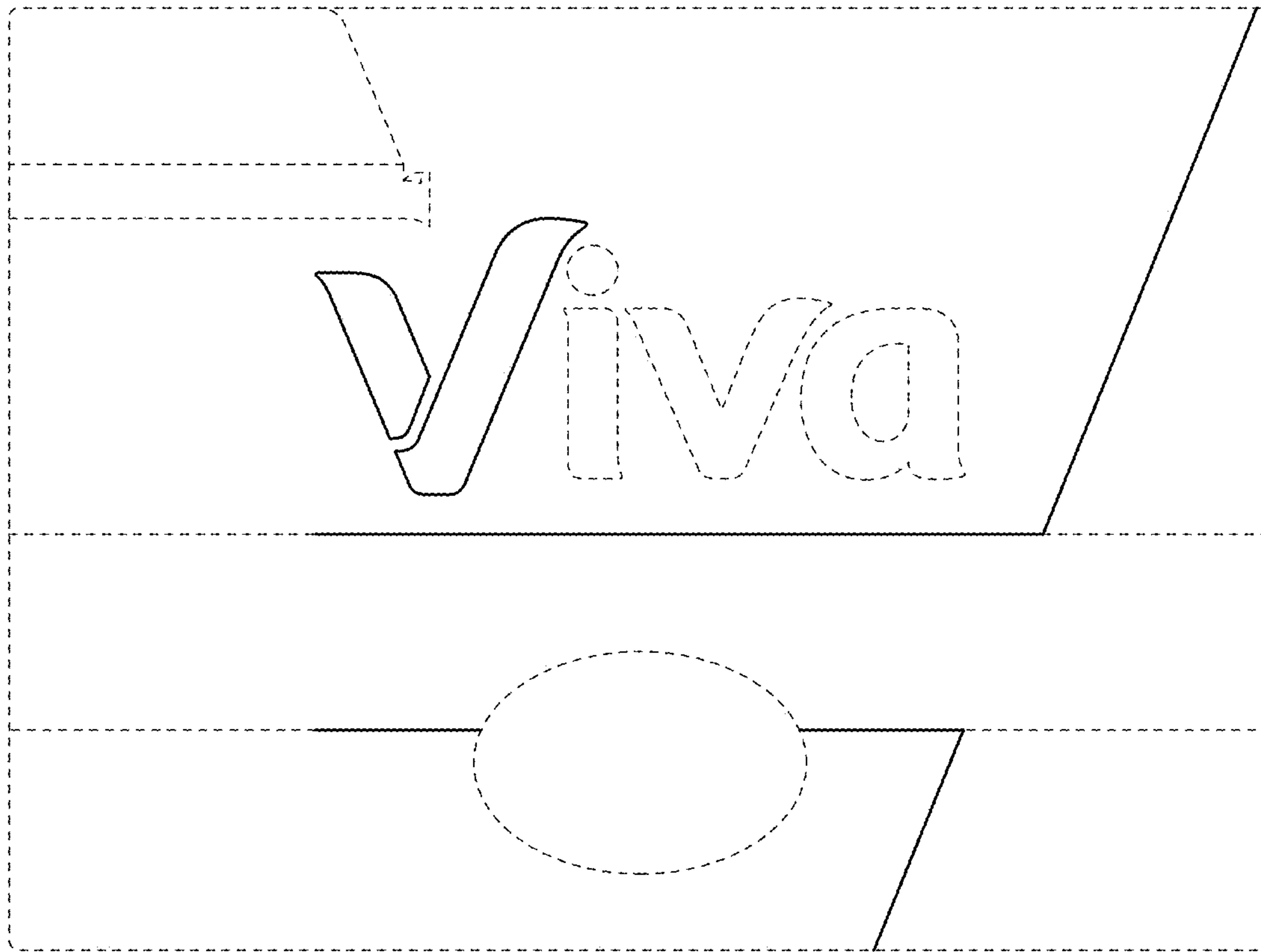

FIG. 2



FIG. 3

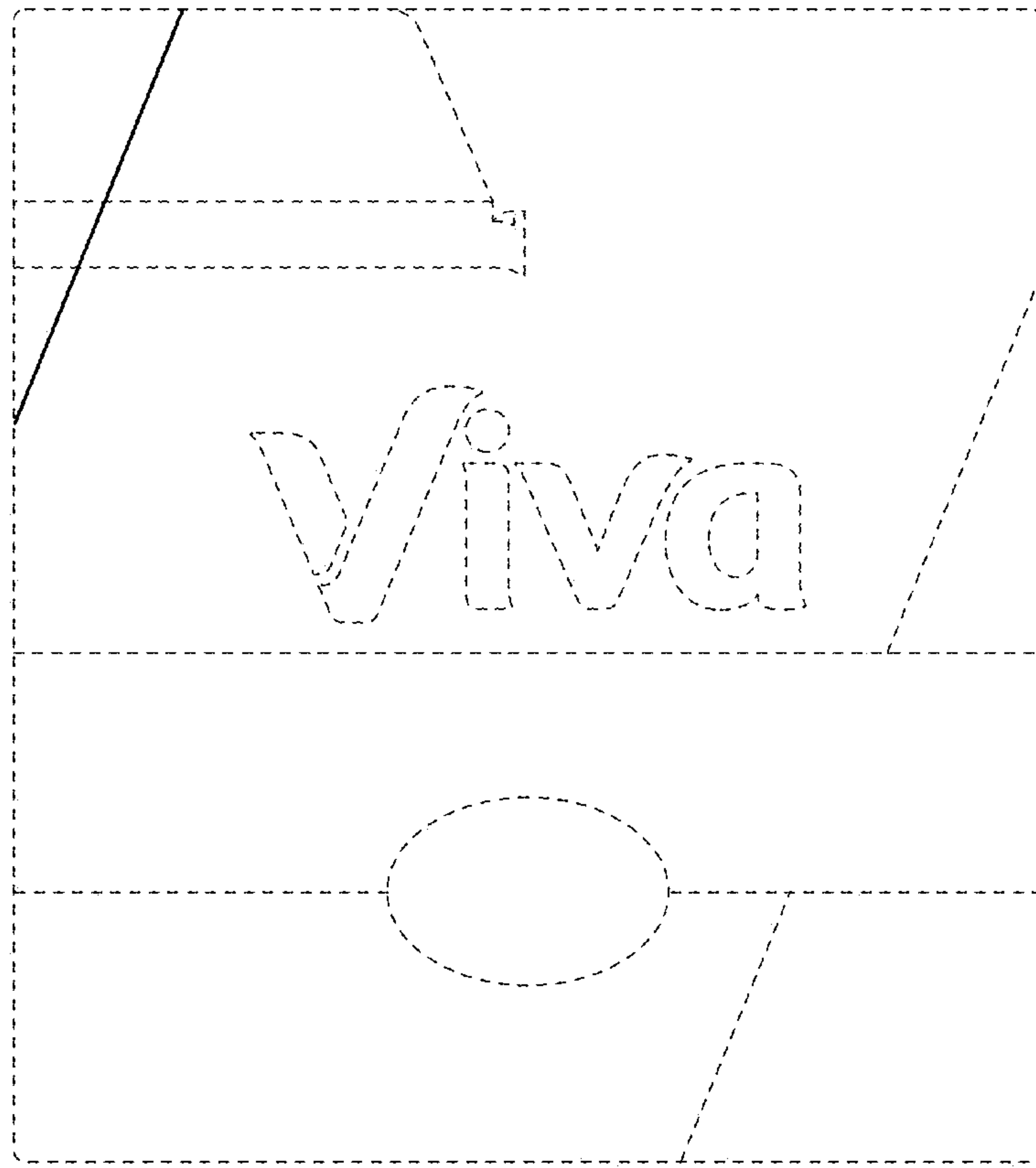

FIG. 4

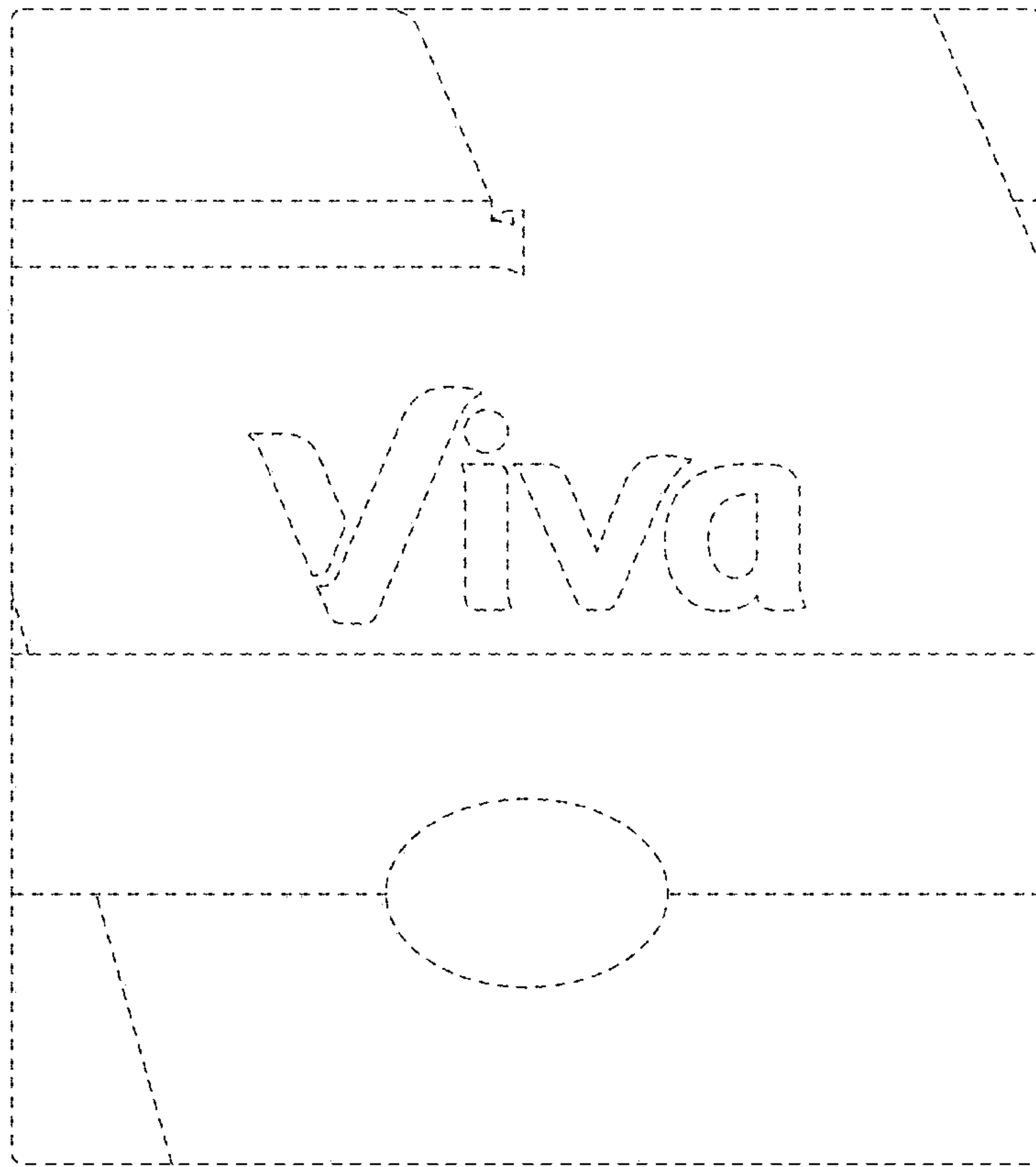

FIG. 5

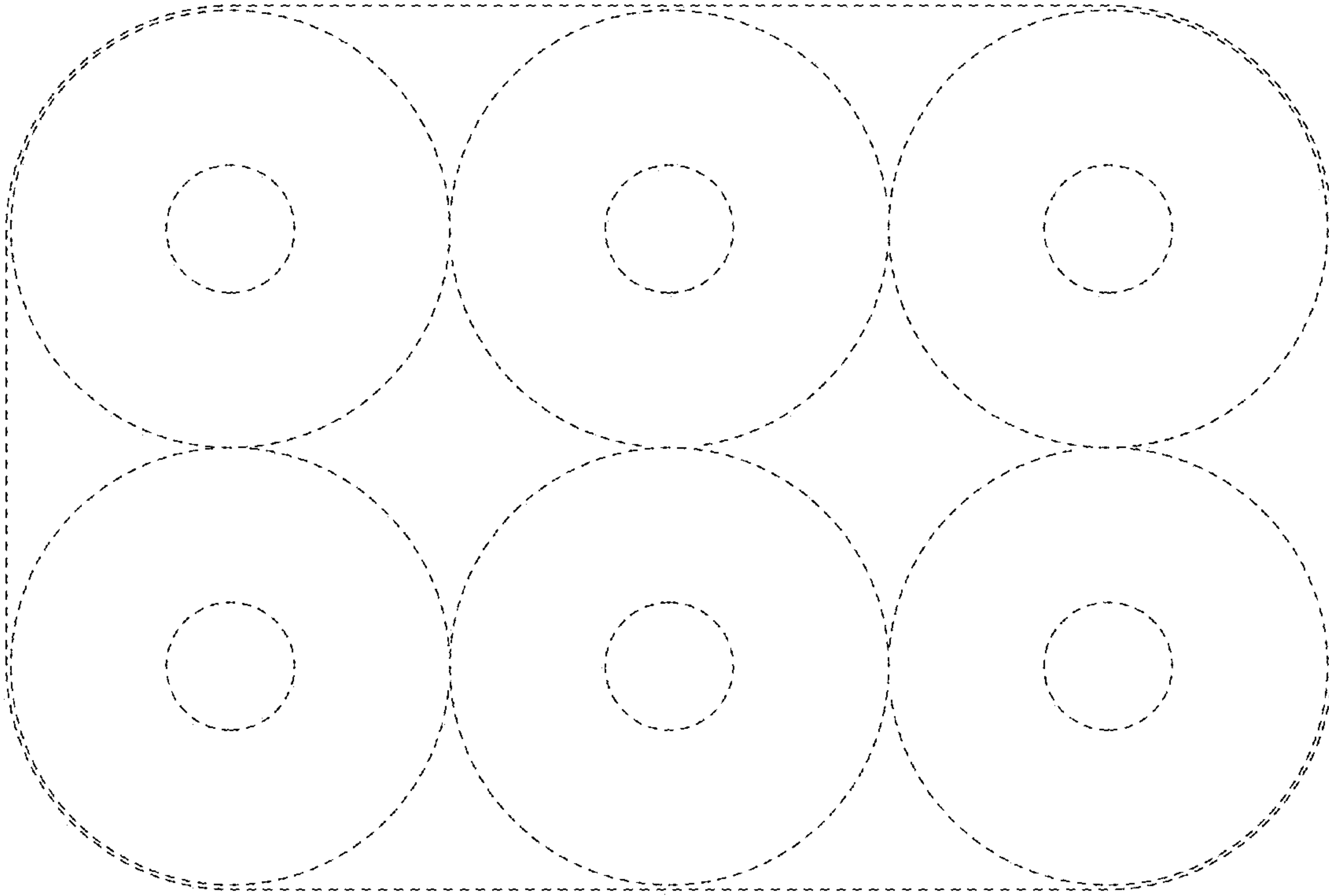

FIG. 6

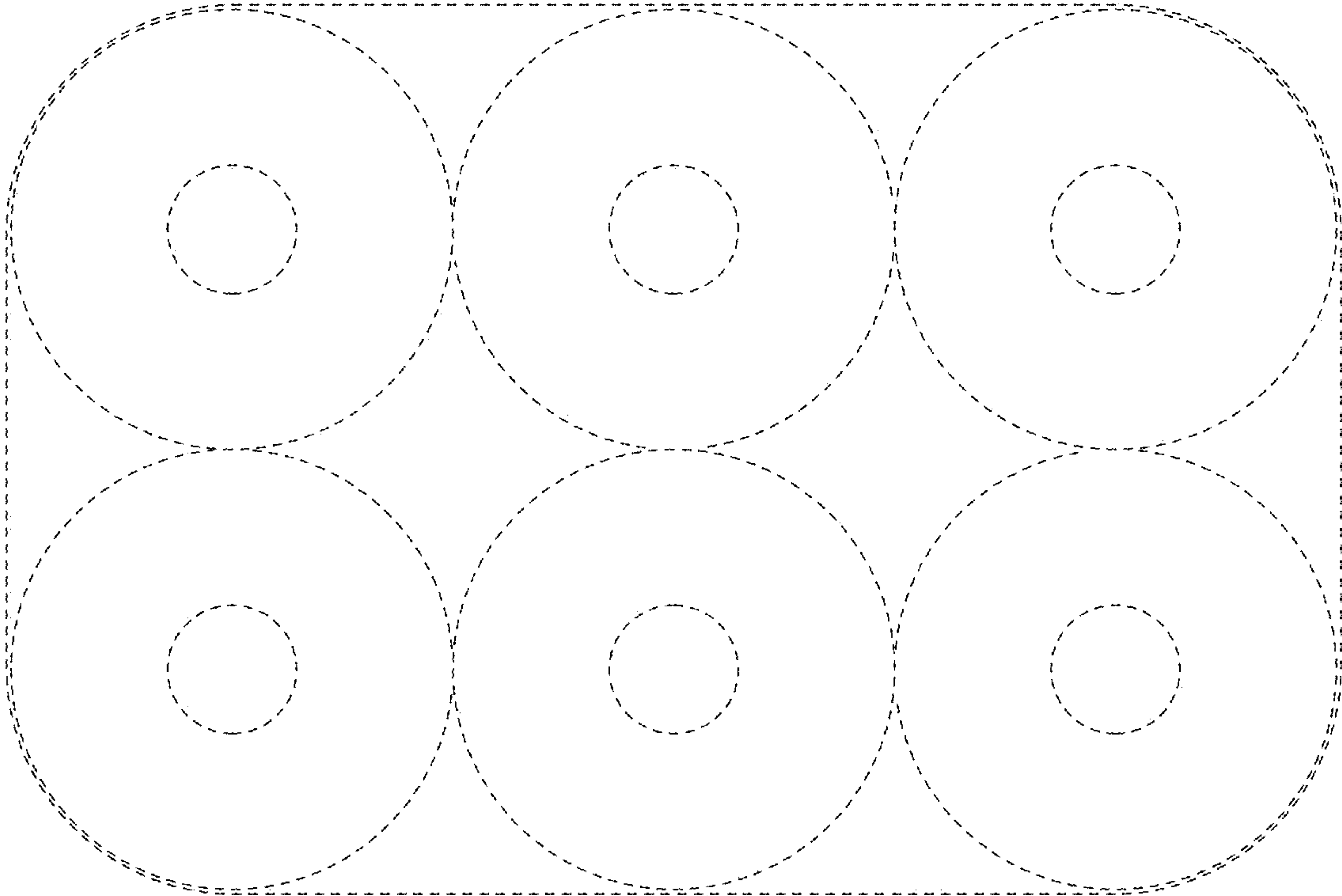

FIG. 7