



US00D945227S

(12) **United States Design Patent** (10) **Patent No.:** **US D945,227 S**  
**Li** (45) **Date of Patent:** **\*\* Mar. 8, 2022**

(54) **HERB GRINDER**  
(71) Applicant: **Guangzhou Jin Zhong Wang Luo Ji**  
**Shu You Xian Gong Si**, Guangzhou  
(CN)  
(72) Inventor: **Jinkun Li**, Guangzhou (CN)  
(\*\*) Term: **15 Years**  
(21) Appl. No.: **29/778,120**  
(22) Filed: **Apr. 11, 2021**  
(51) **LOC (13) Cl.** ..... **07-04**  
(52) **U.S. Cl.**  
USPC ..... **D7/679**; D27/194  
(58) **Field of Classification Search**  
USPC ..... D7/679, 372, 373, 374, 383, 384, 401.1;  
D27/194, 195; D24/220  
CPC ..... B02C 18/24; B02C 18/08; B02C 18/16;  
B02C 18/00; B02C 7/00; B02C 7/02;  
B02C 7/04; A47J 42/00; A47J 42/04;  
A47J 42/14; A47J 42/24; A47J 42/34;  
A47J 42/36; A47J 42/20; A47J 43/25;  
A47J 43/255; A47J 43/04; A47J 43/06;  
B26B 27/00; A24B 7/00; A24F 23/04  
See application file for complete search history.

D804,093 S 11/2017 Chen  
D813,618 S 3/2018 Witko et al.  
D842,537 S 3/2019 Booth  
D862,537 S 10/2019 Larose  
D894,668 S 9/2020 Feng  
D907,236 S 1/2021 Lee  
2012/0168544 A1\* 7/2012 Chaoui ..... A47J 42/24  
241/68  
2016/0100715 A1\* 4/2016 Staiano ..... A47J 42/34  
241/79  
2017/0202396 A1\* 7/2017 Gumbel ..... A47J 42/12  
2018/0199759 A1\* 7/2018 Qiu ..... A47J 42/20  
2018/0206675 A1\* 7/2018 Mennillo ..... A47J 42/14

\* cited by examiner

*Primary Examiner* — Terry A Wallace  
(74) *Attorney, Agent, or Firm* — Xiaofang Zhong; Law  
Office of Xiaofang Zhong, PLLC

(57) **CLAIM**

The ornamental design for an herb grinder, as shown and described.

**DESCRIPTION**

FIG. 1 is a perspective view of an herb grinder showing my new design;  
FIG. 2 is a front elevational view thereof;  
FIG. 3 is a rear elevational view thereof;  
FIG. 4 is a right side elevational view thereof;  
FIG. 5 is a left side elevational view thereof;  
FIG. 6 is a top plan view thereof;  
FIG. 7 is a bottom plan view thereof; and,  
FIG. 8 is an exploded perspective view of the herb grinder.  
The broken lines in the drawings depict portions of the herb grinder that form no part of the claimed design.

**1 Claim, 8 Drawing Sheets**

(56) **References Cited**  
U.S. PATENT DOCUMENTS  
D474,378 S 5/2003 Brandenburg  
D669,747 S 10/2012 Grant  
D714,595 S 10/2014 Ducey  
D755,022 S 5/2016 Dukat  
D761,064 S 7/2016 Dukat

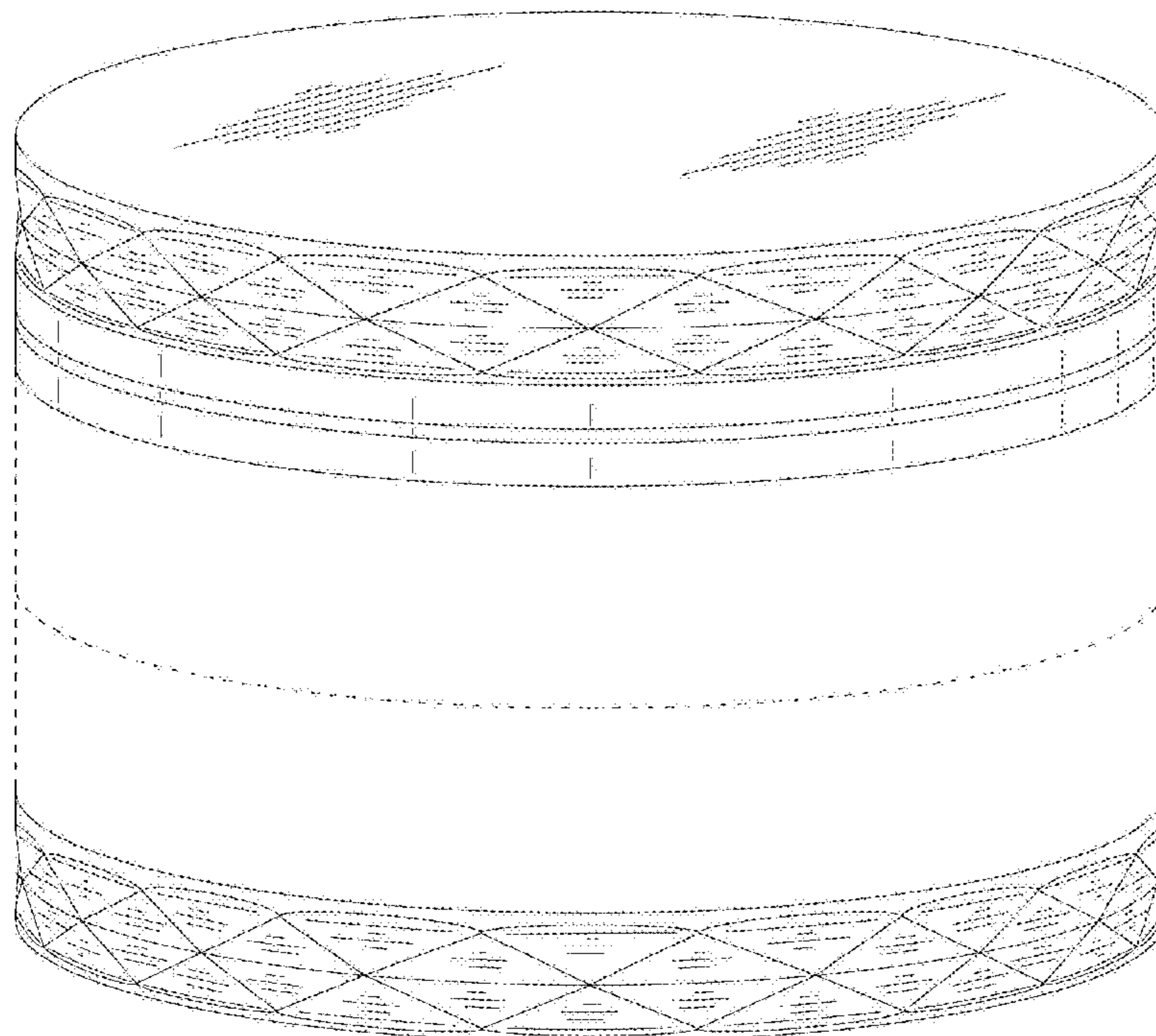

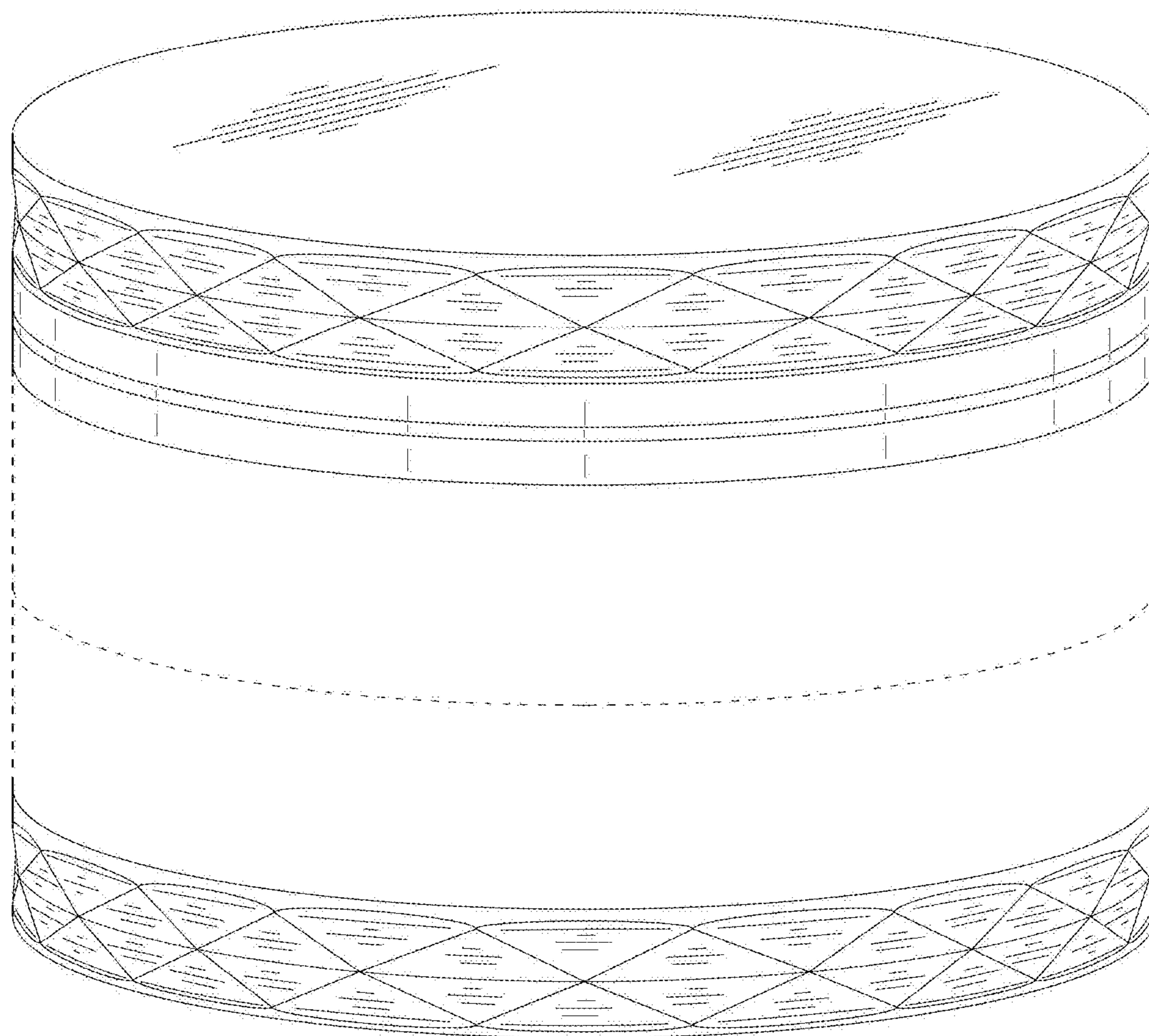

FIG. 1

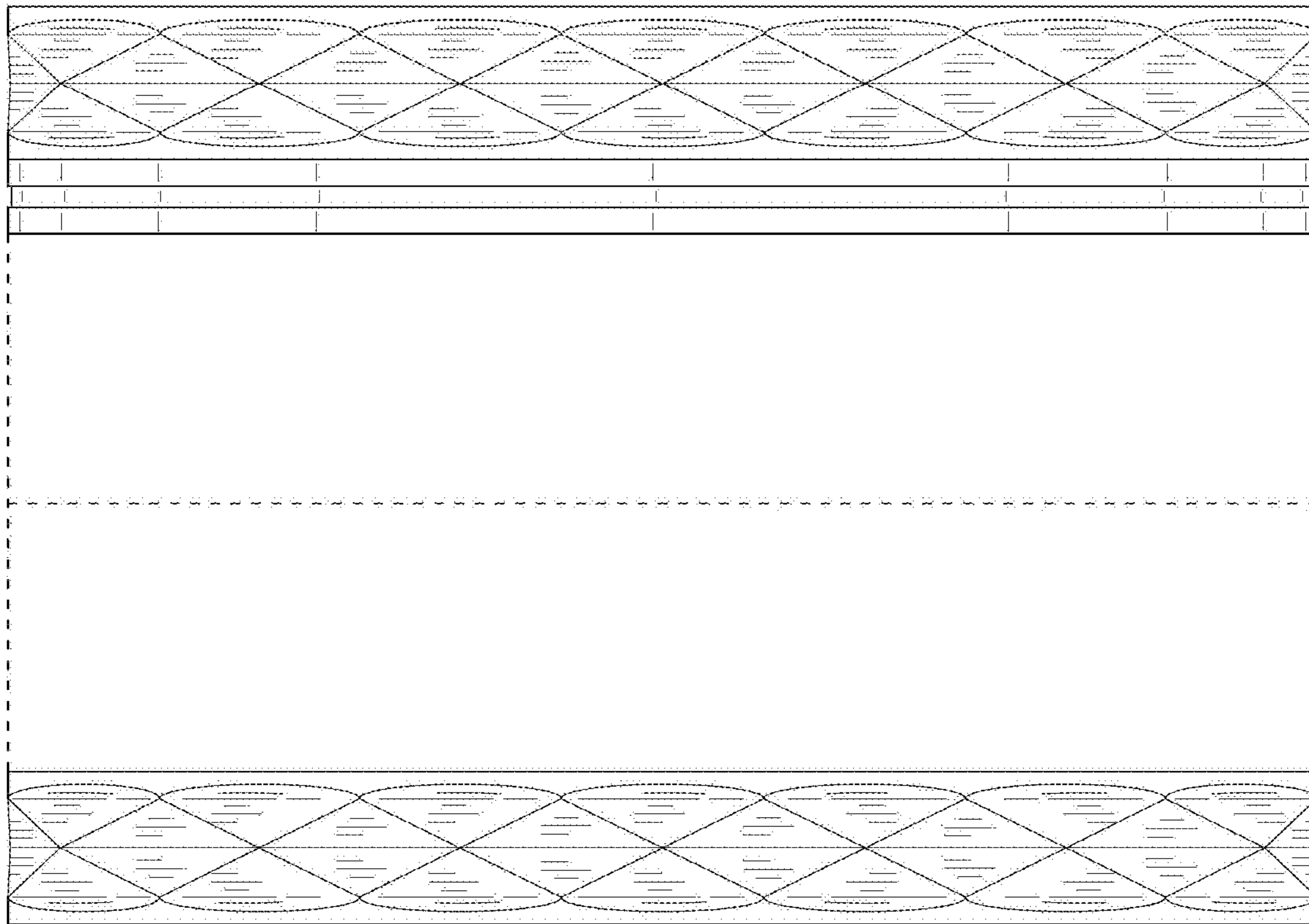

FIG. 2

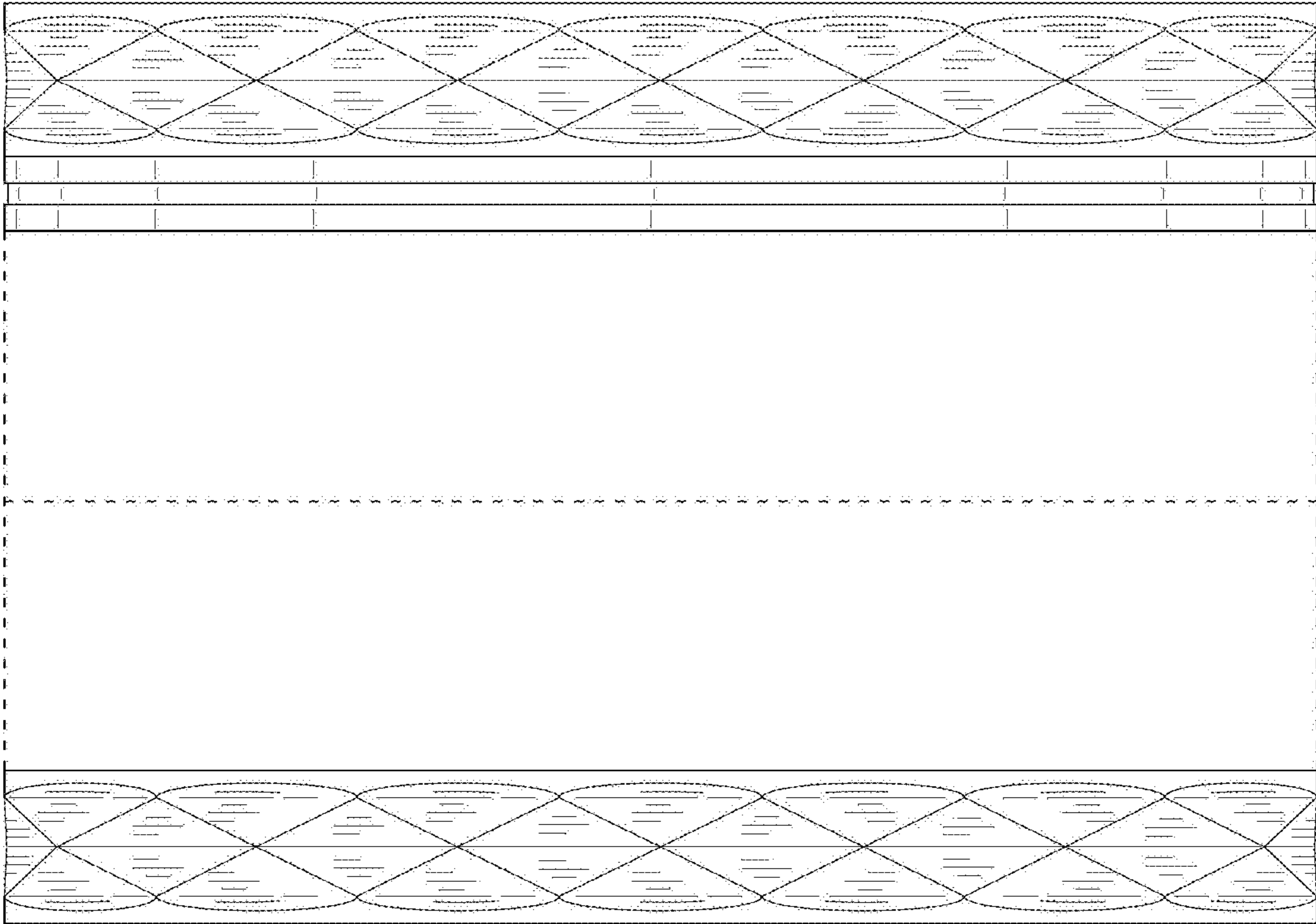

FIG. 3

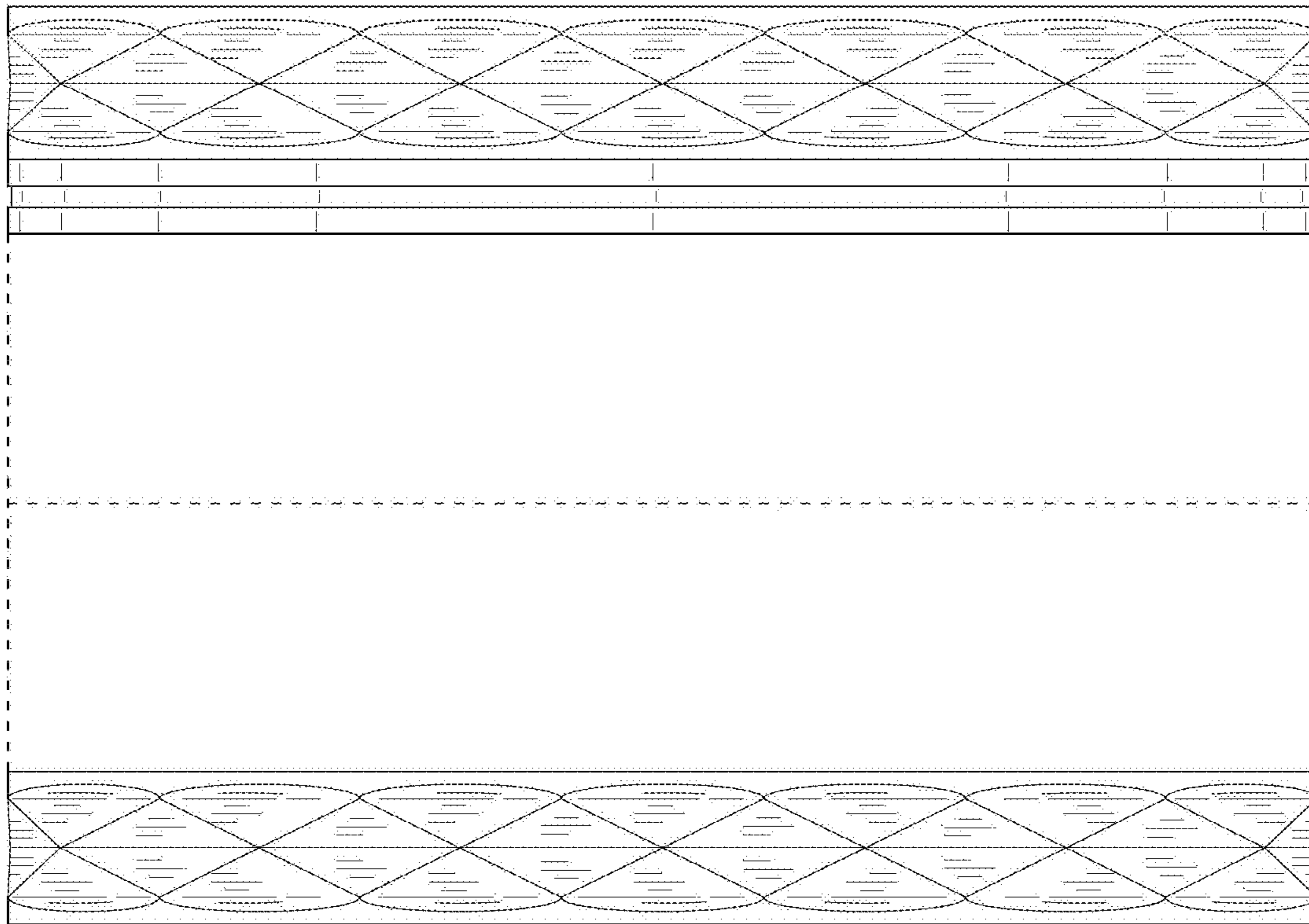

FIG. 4

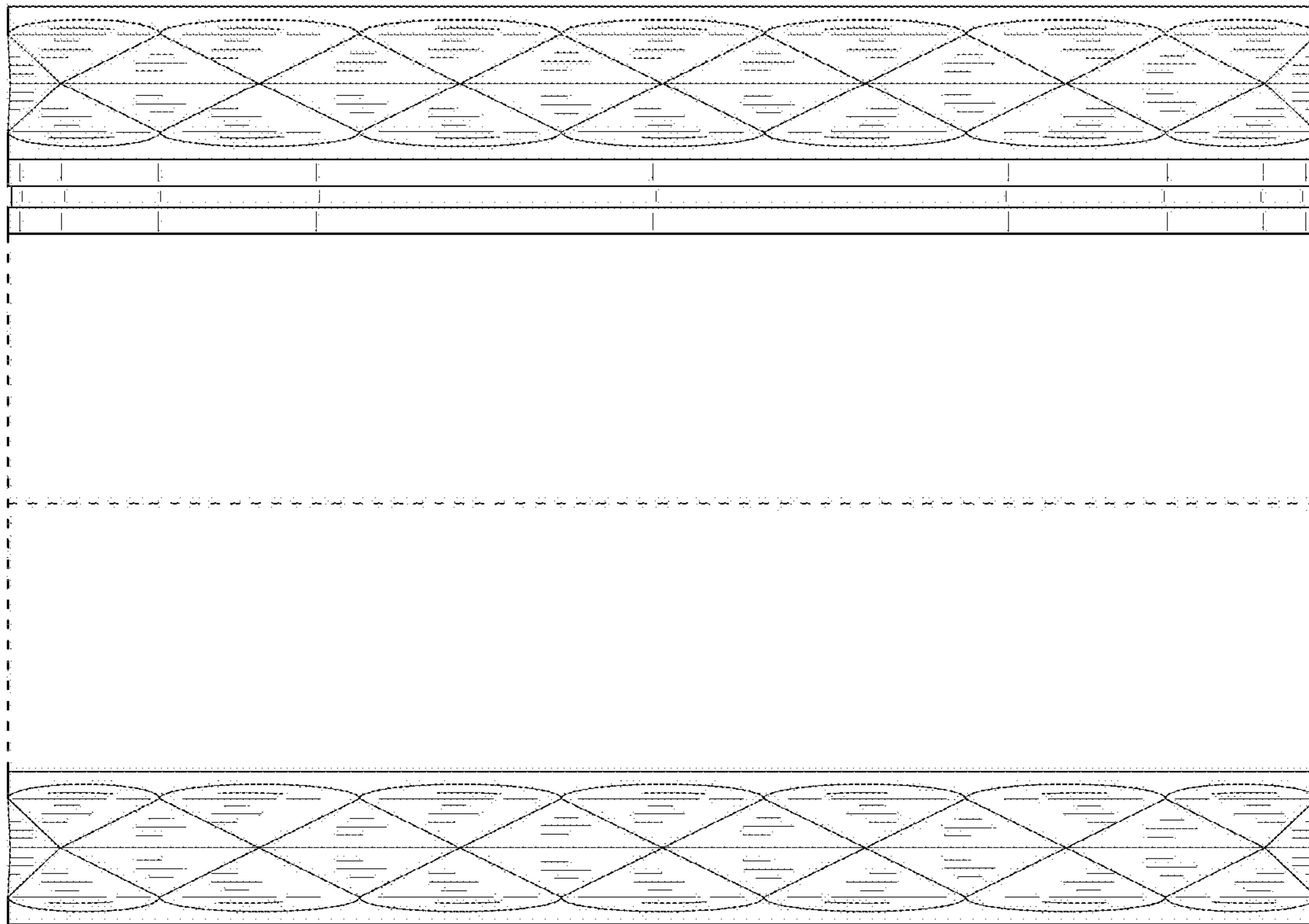

FIG. 5

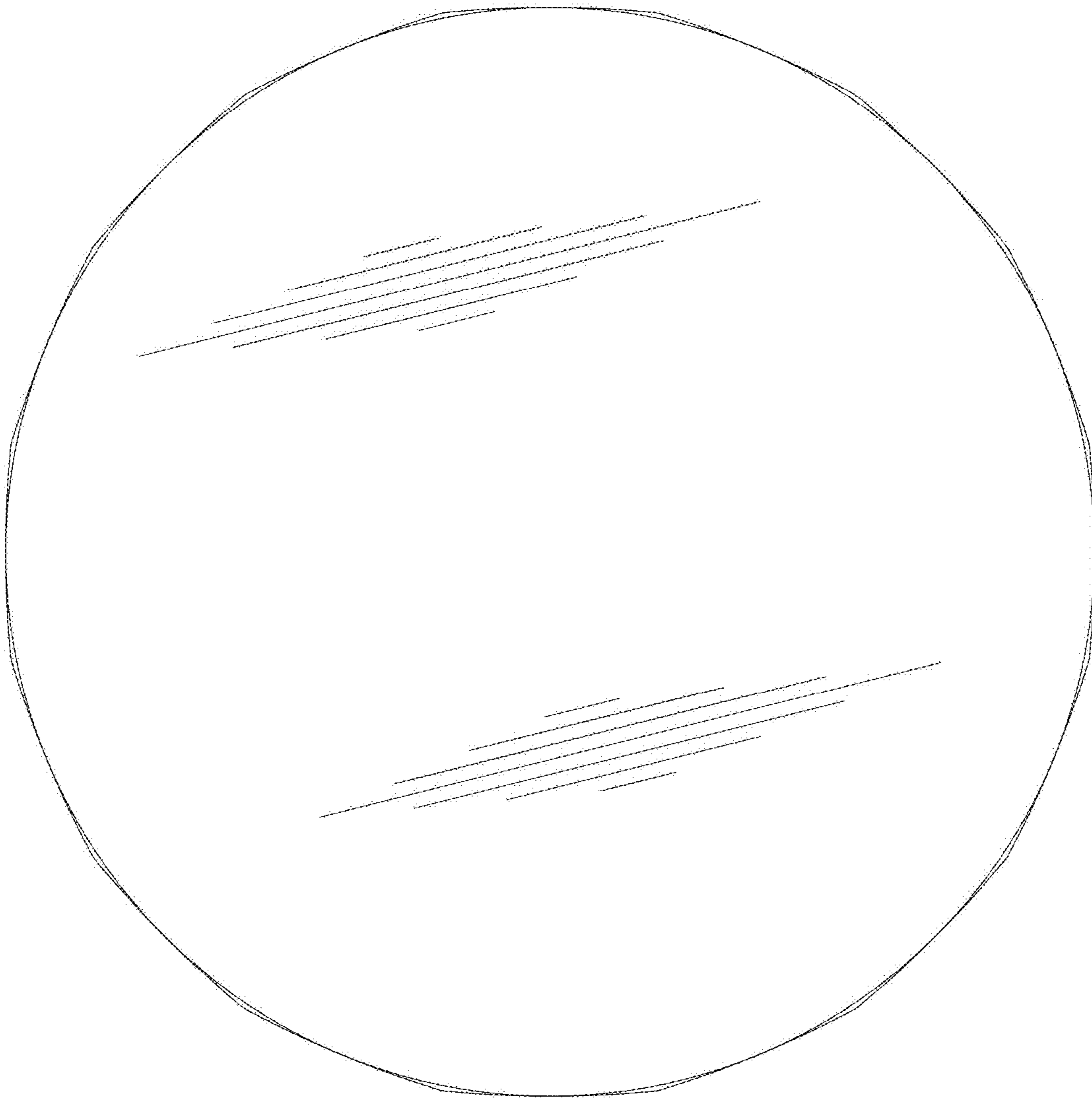

FIG. 6

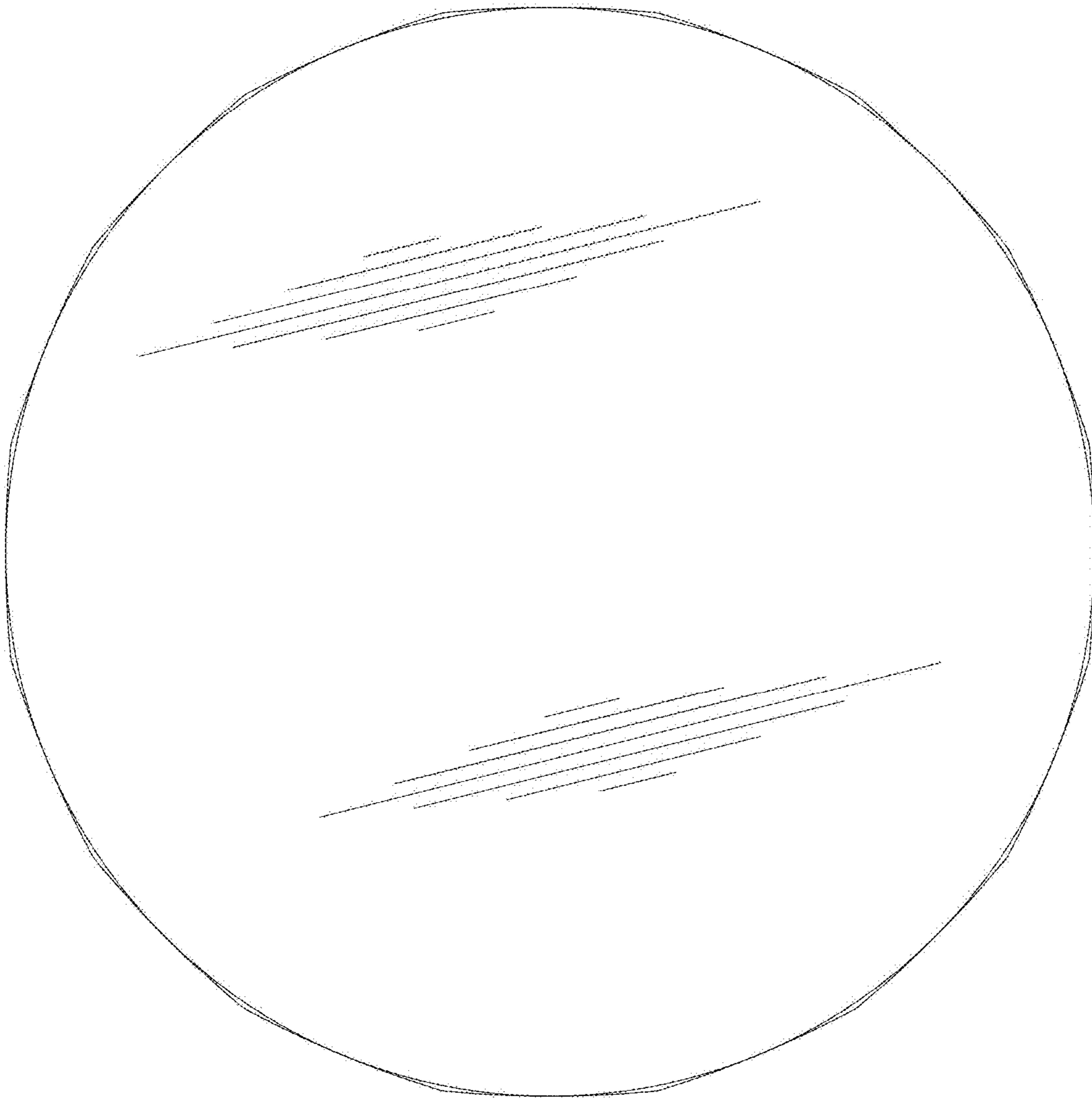

FIG. 7



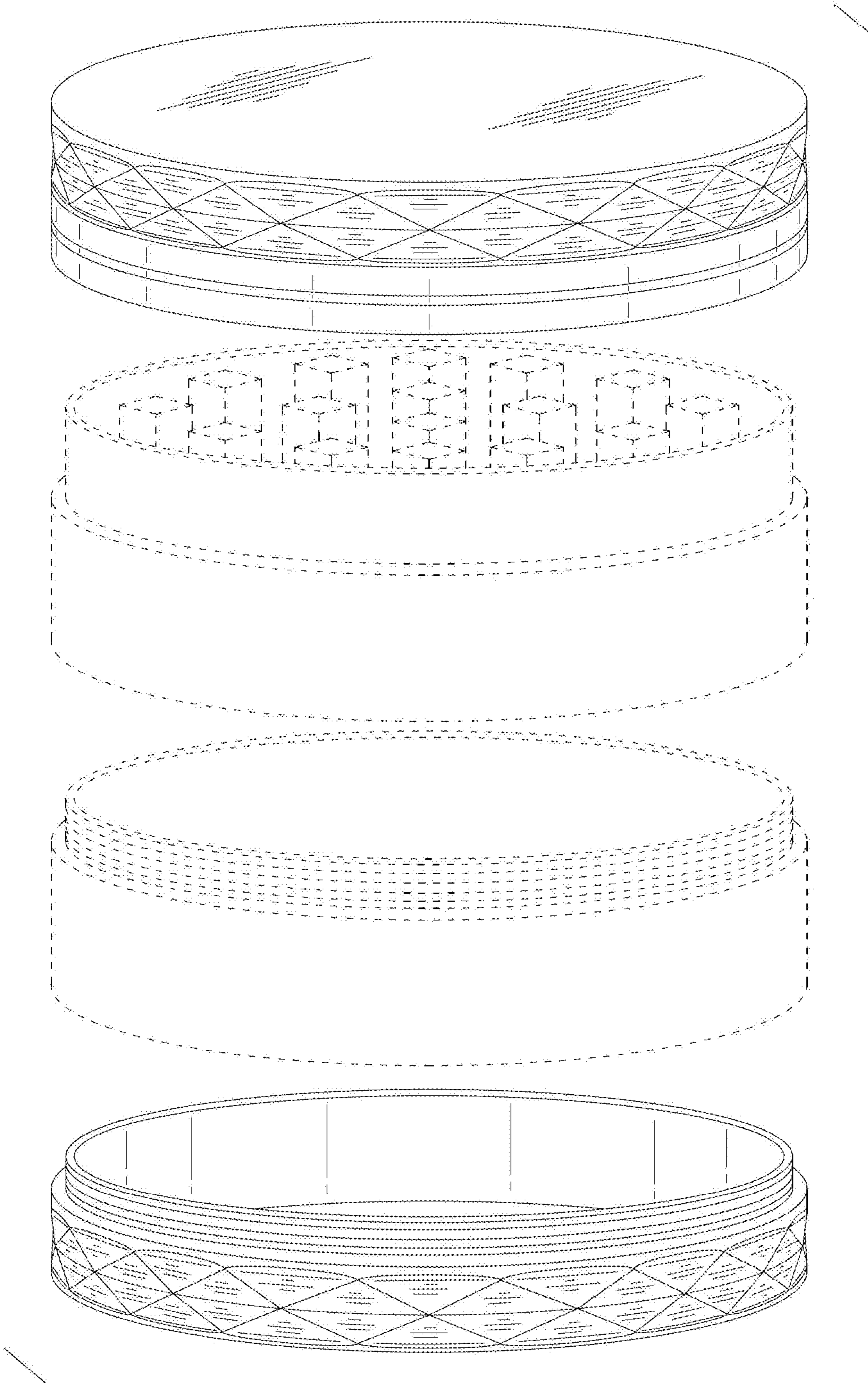

FIG. 8