



US00D945202S

(12) **United States Design Patent**  
**de Jesus Estima et al.**

(10) **Patent No.:** **US D945,202 S**  
(45) **Date of Patent:** **\*\* Mar. 8, 2022**

(54) **ESPRESSO COFFEE MACHINE**  
(71) Applicant: **NOVADELTA—COMÉRCIO E INDÚSTRIA DE CAFÉS LDA,**  
Lisbon (PT)  
(72) Inventors: **José Miguel de Jesus Estima,** Lisbon (PT); **Rui Miguel Nabeiro,** Campo Maior (PT)  
(73) Assignee: **NOVADELTA—COMÉRCIO E INDÚSTRIA DE CAFÉS LDA,**  
Lisbon (PT)

D386,944 S \* 12/1997 Demore ..... D23/209  
D506,525 S \* 6/2005 Wang ..... D23/207  
D518,677 S \* 4/2006 Van Berlo ..... D7/306  
D646,749 S \* 10/2011 Morad ..... D23/209  
D648,971 S \* 11/2011 Goralski ..... D7/306  
D673,241 S \* 12/2012 Choi ..... D23/207  
D723,315 S \* 3/2015 Wilder ..... D7/306  
D741,982 S \* 10/2015 Maeng ..... D23/207  
D878,844 S \* 3/2020 Zisman ..... D7/306  
D908,834 S \* 1/2021 Cho ..... D23/207  
D914,834 S \* 3/2021 Cho ..... D23/207

(\*\*) Term: **15 Years**  
(21) Appl. No.: **35/509,986**  
(22) Filed: **Jul. 16, 2020**

**FOREIGN PATENT DOCUMENTS**

GB 8209488000-1000 \* 7/2020

\* cited by examiner

*Primary Examiner* — S. Bryan Reinholdt, Jr.  
(74) *Attorney, Agent, or Firm* — Sughrue Mion, PLLC

(80) **Hague Agreement Data**

Int. Filing Date: **Jul. 16, 2020**  
Int. Reg. No.: **DM/209488**  
Int. Reg. Date: **Jul. 16, 2020**  
Int. Reg. Pub. Date: **Aug. 7, 2020**

(57) **CLAIM**

The ornamental design for an espresso coffee machine, as shown and described.

(51) **LOC (13) Cl.** ..... **07-01**  
(52) **U.S. Cl.**  
USPC ..... **D7/309; D23/207**  
(58) **Field of Classification Search**  
USPC ..... D7/300, 306, 309, 311; D23/202, 209, D23/207  
CPC ..... A47J 31/00; A47J 31/005; A47J 31/02  
See application file for complete search history.

**DESCRIPTION**

FIG. 1.1 is a front, right, and top perspective view of the espresso coffee machine showing our new design; FIG. 1.2 is a right side elevation view thereof; FIG. 1.3 is a left side elevation view thereof; FIG. 1.4 is a top plan view thereof; FIG. 1.5 is a bottom plan view thereof; FIG. 1.6 is a front elevation view thereof; and FIG. 1.7 is a rear elevation view thereof. The broken lines and the areas within them depict portions of the espresso coffee machine that form no part of the claim.

(56) **References Cited**

**U.S. PATENT DOCUMENTS**

2,657,554 A \* 11/1953 Hull ..... B67D 3/0012  
62/392  
D341,984 S \* 12/1993 Nurmesniemi ..... D7/300

**1 Claim, 7 Drawing Sheets**

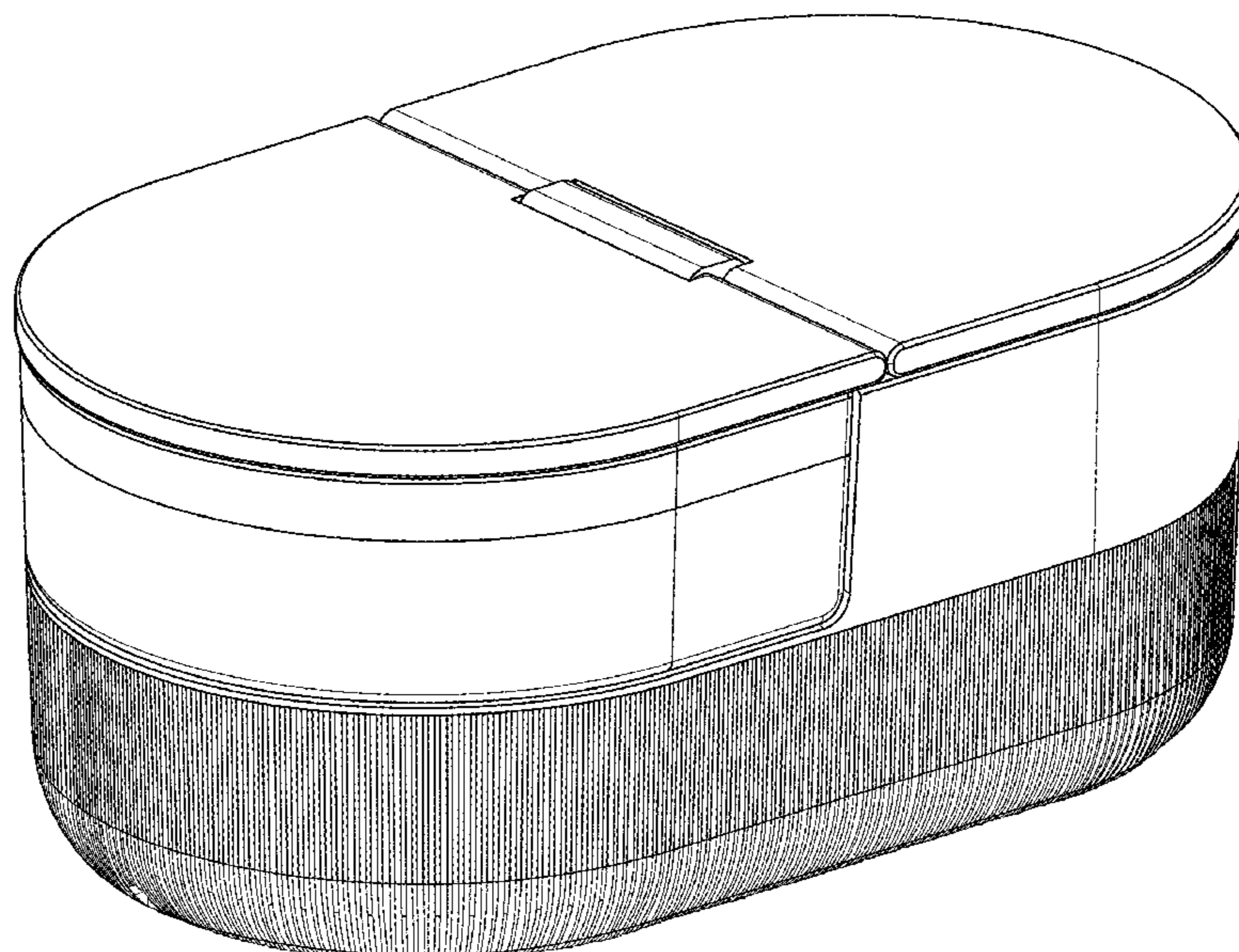

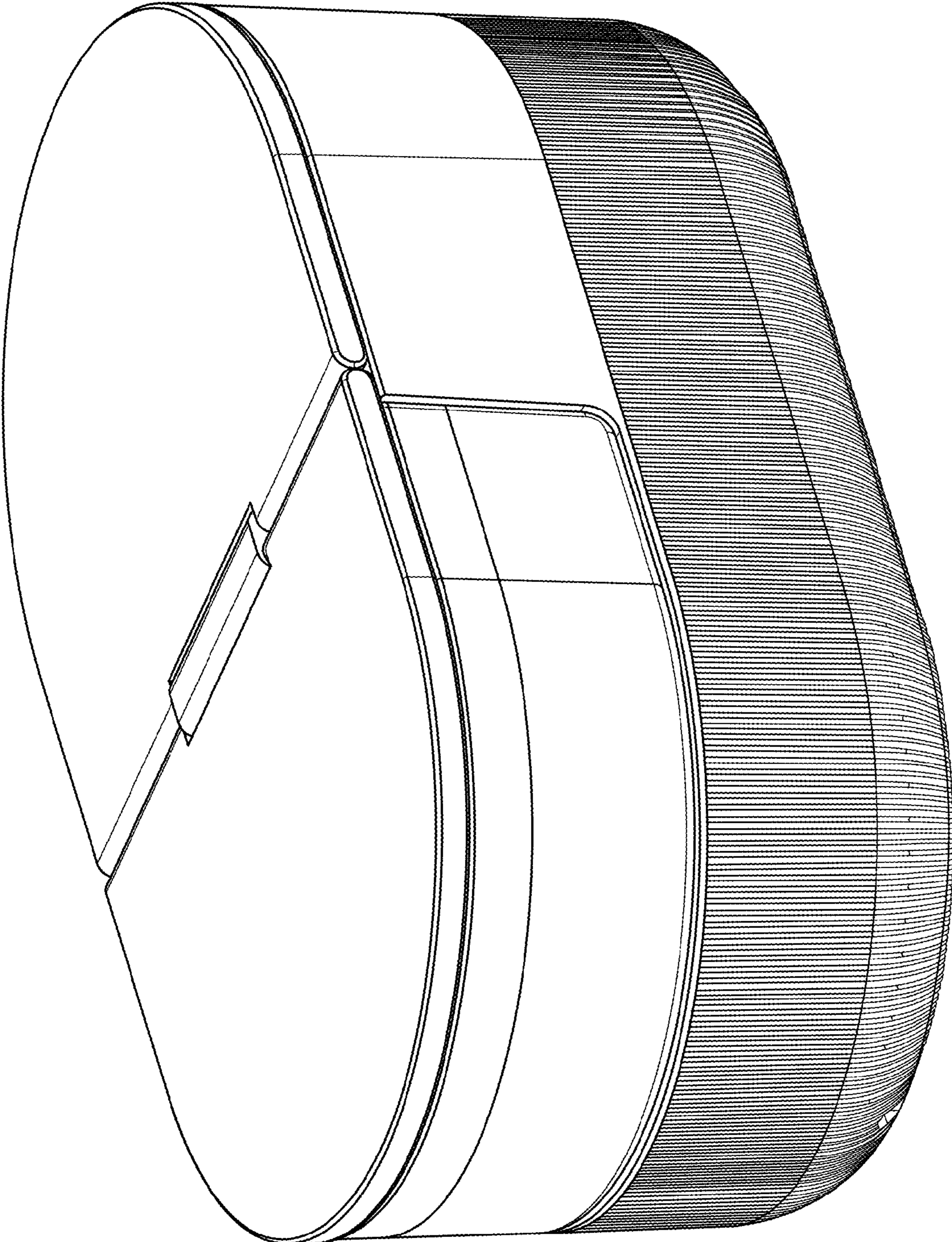

FIG. 1.1

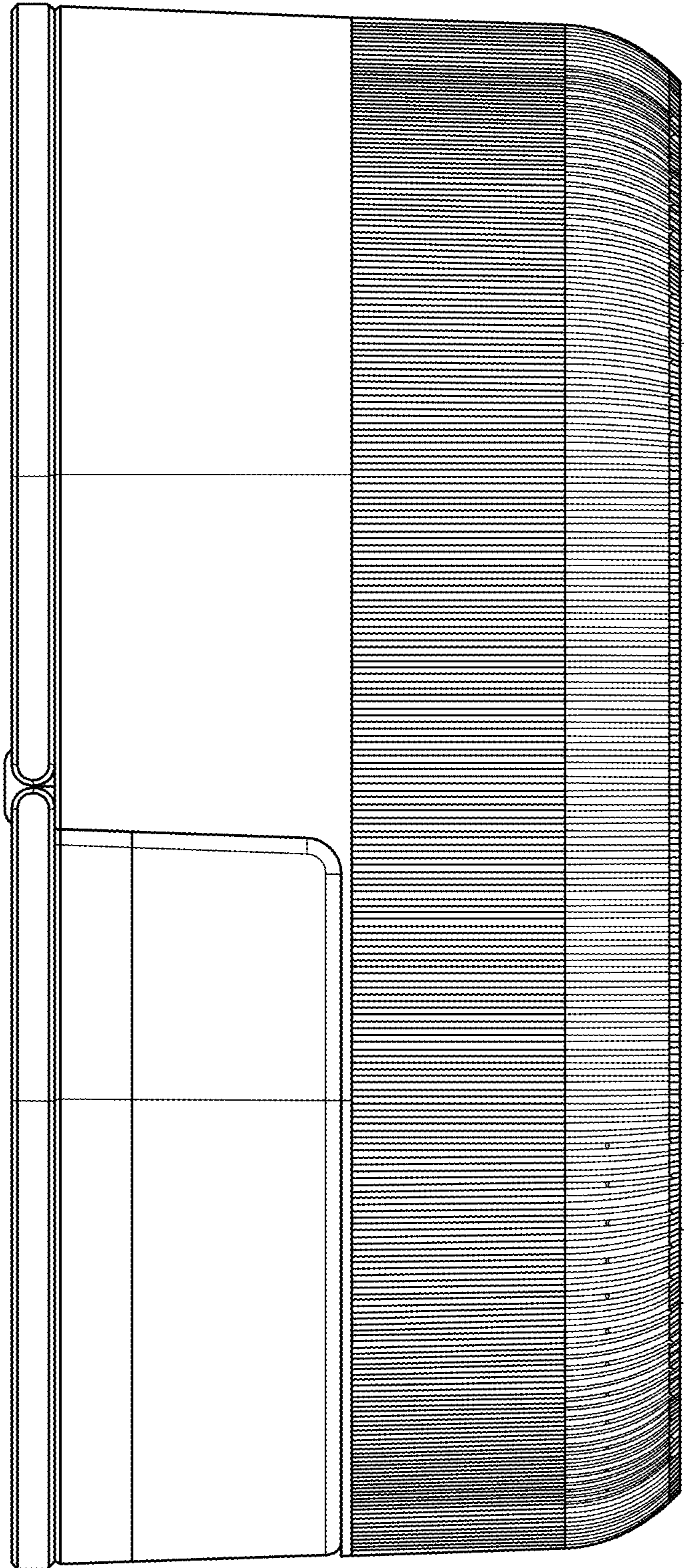

FIG. 1.2

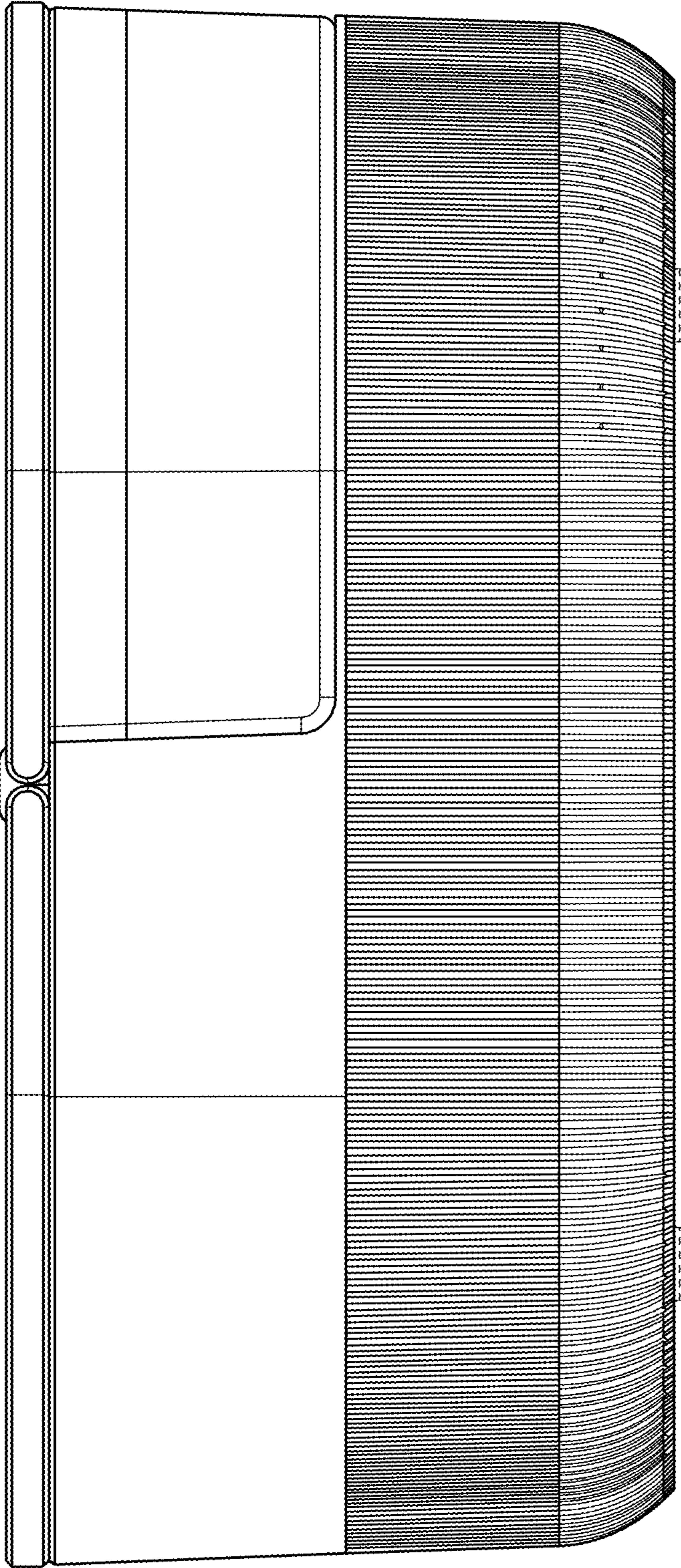

FIG. 1.3

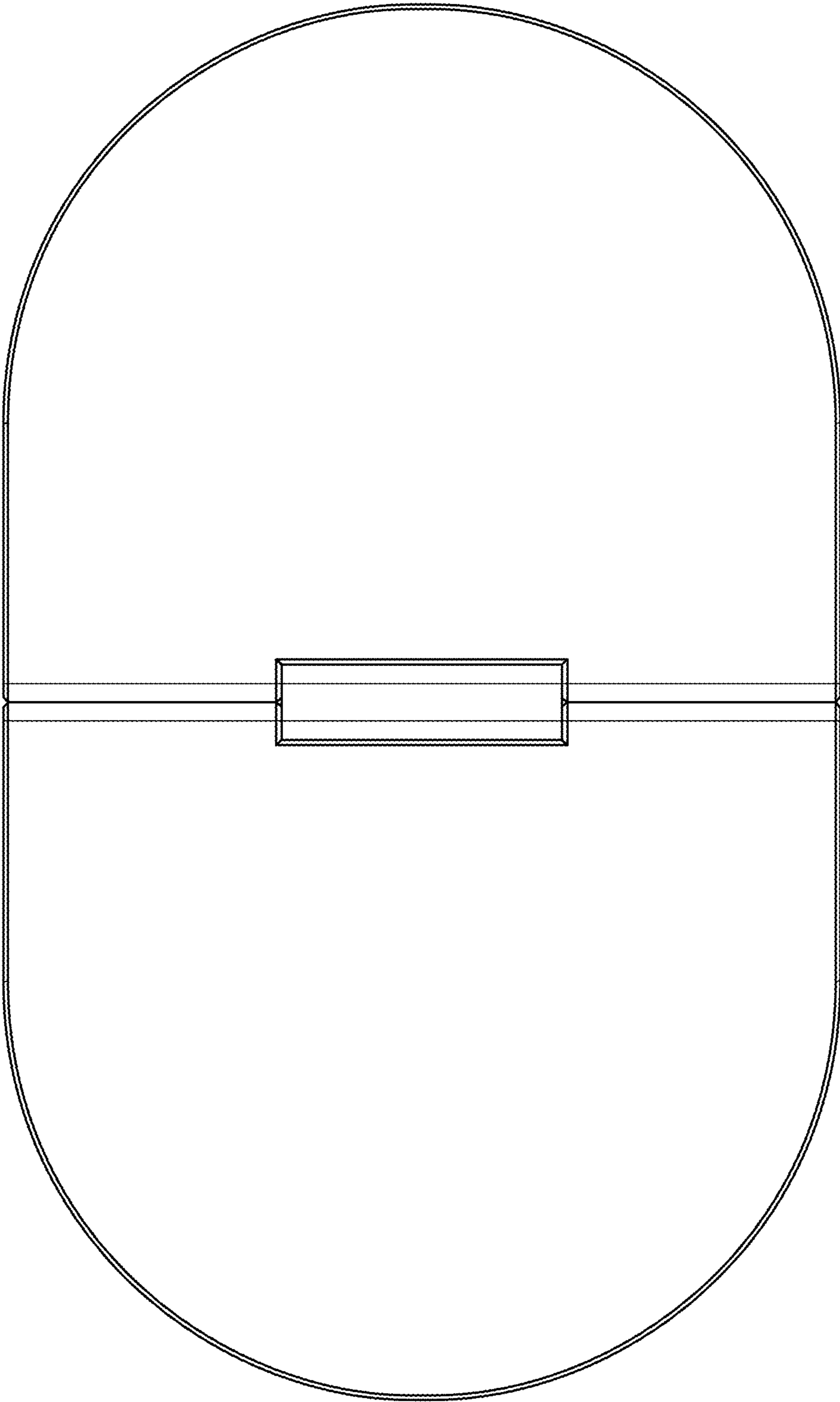

FIG. 1.4

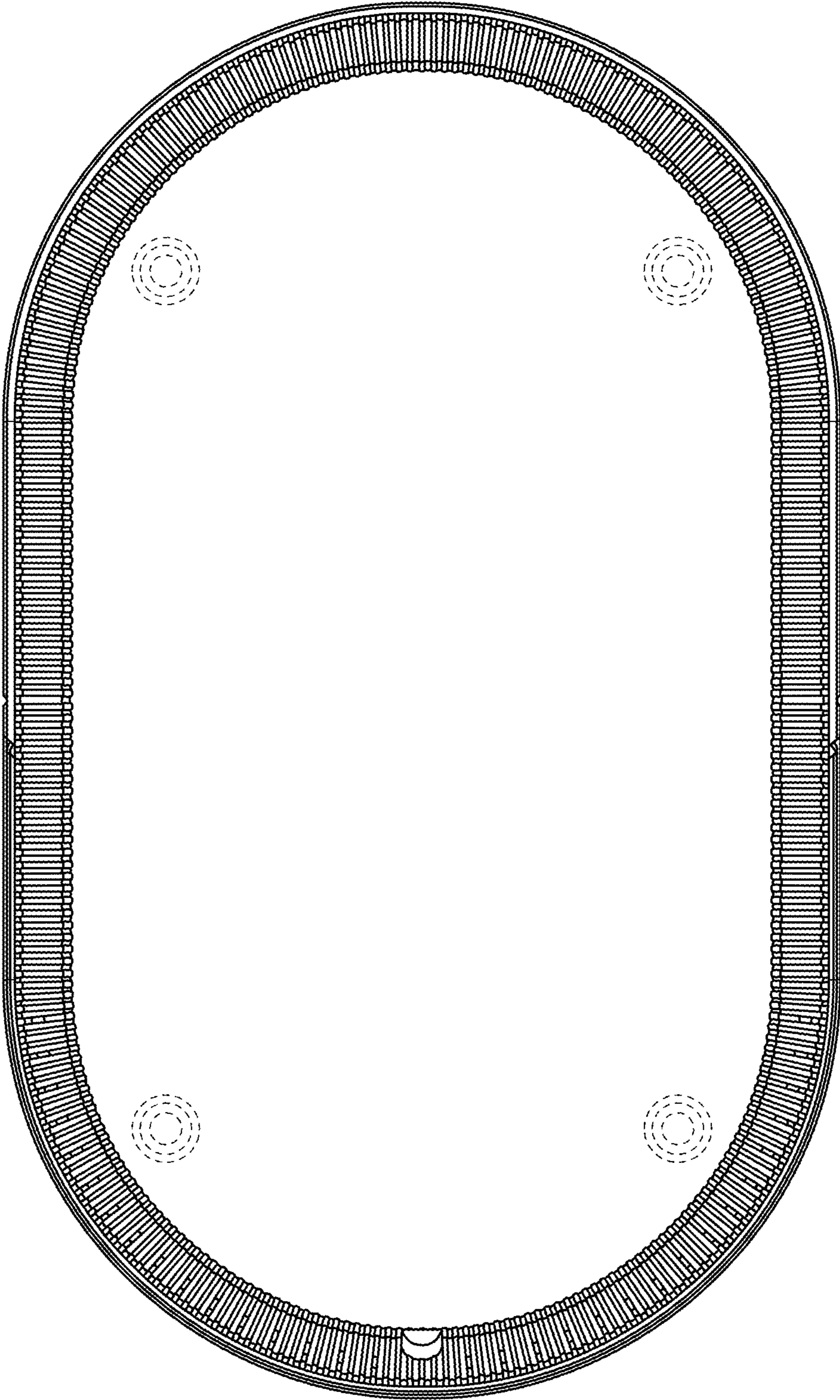

FIG. 1.5

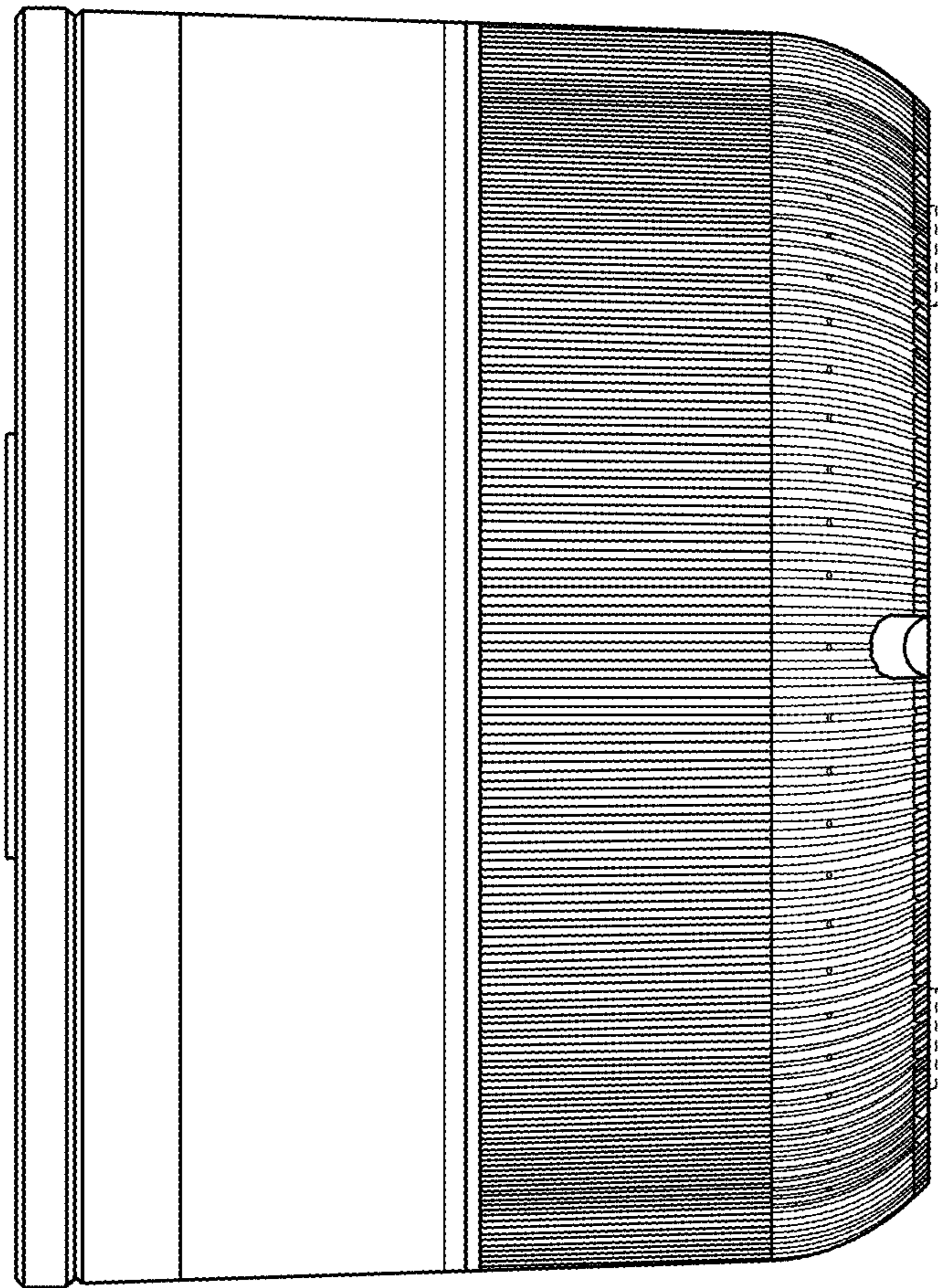

FIG. 1.6

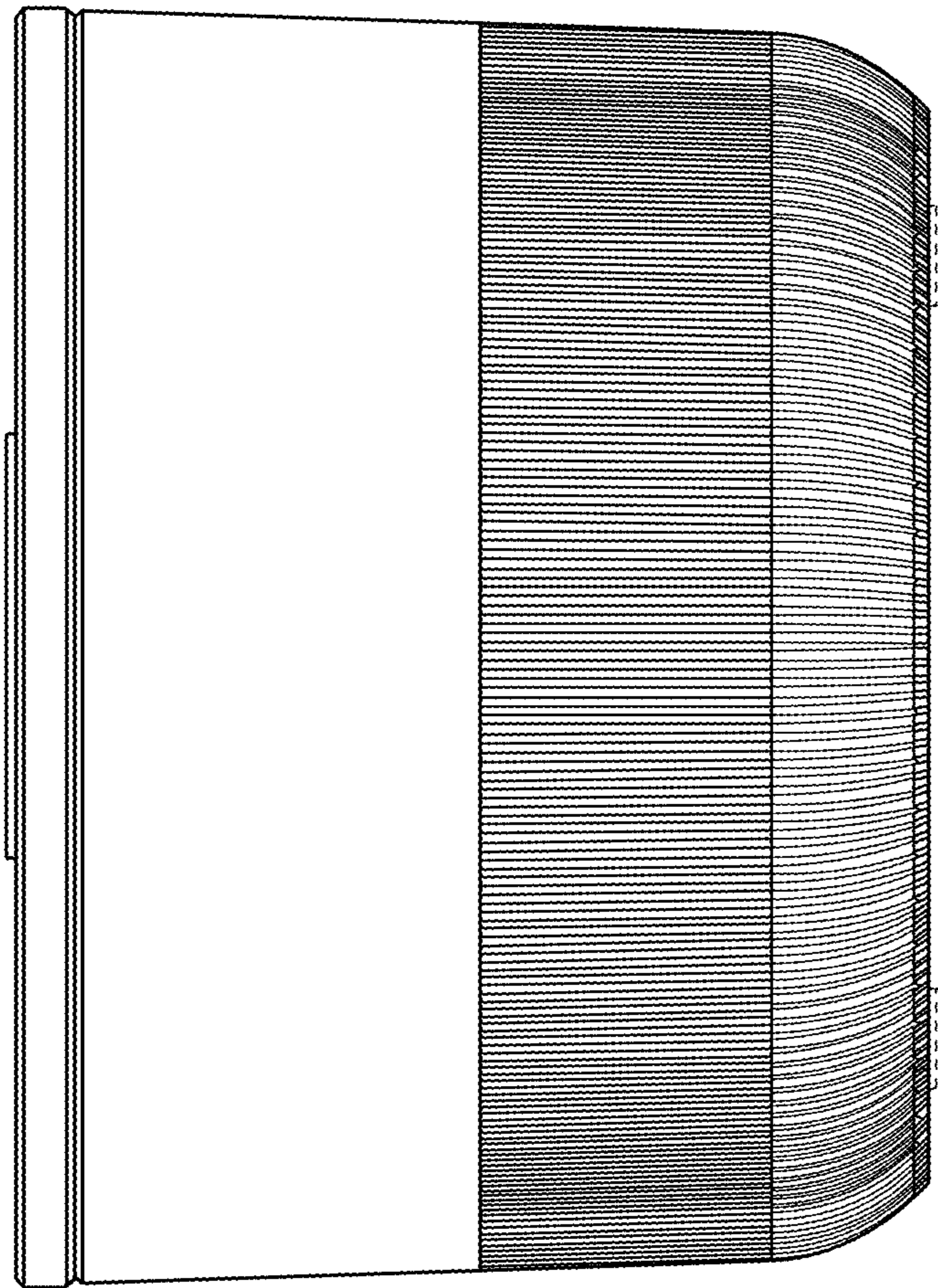

FIG. 1.7