



US00D945160S

(12) **United States Design Patent** (10) **Patent No.:** **US D945,160 S**
Birdwell (45) **Date of Patent:** **** Mar. 8, 2022**

(54) **PACKING CUBE**
(71) Applicant: **Real Value LLC**, Moore, OK (US)
(72) Inventor: **Ben Birdwell**, Oklahoma City, OK (US)
(73) Assignee: **Real Value LLC**, Moore, OK (US)
(**) Term: **15 Years**
(21) Appl. No.: **29/752,569**
(22) Filed: **Sep. 28, 2020**
(51) **LOC (13) Cl.** **03-01**
(52) **U.S. Cl.**
USPC **D3/301**
(58) **Field of Classification Search**
USPC D3/273, 276, 283, 284, 285, 289, 301
CPC A45C 5/005; A45C 3/00
See application file for complete search history.

(56) **References Cited**
U.S. PATENT DOCUMENTS
1,980,714 A * 11/1934 Brady A45C 13/02
190/109
D389,647 S * 1/1998 White D3/285
D396,750 S * 8/1998 Slater D3/284
D457,314 S * 5/2002 Stephens D3/276
D481,205 S * 10/2003 Parrott D19/86
D645,251 S * 9/2011 Lee D3/301
D790,211 S * 6/2017 Constantini D3/205
D841,974 S * 3/2019 Peng D3/205
D867,759 S * 11/2019 Liu D3/303
D874,144 S * 2/2020 Itoi D3/301
D879,462 S * 3/2020 Si D3/206
2006/0196744 A1 * 9/2006 Greiner A45C 13/02
190/110

OTHER PUBLICATIONS
AmazonBasics 4 Piece Packing Travel Organizer Cubes Set, announced May 24, 2016 [online], [site visited Dec. 17, 2021]. Available from

internet, URL: <<https://www.amazon.ca/Amazon-Basics-Packing-Travel-Organizer/dp/B014VBIEZQ>> (Year: 2016).*
JJ Power Travel Packing Cubes, announced Aug. 8, 2017 [online], [site visited Dec. 17, 2021]. Available from internet, URL: <<https://www.amazon.com/JJ-POWER-Lightweight-Packing-function/dp/B01MU18ORU?th=1>> (Year: 2017).*

(Continued)

Primary Examiner — Kevin K Rudzinski
Assistant Examiner — Amber J Rabie
(74) *Attorney, Agent, or Firm* — Hall Estill Law Firm

(57) **CLAIM**

The ornamental design for a packing cube, as shown and described.

DESCRIPTION

FIG. 1 is a top, perspective view showing a first embodiment of a new design for a packing cube.
FIG. 2 is a back view of the packing cube of FIG. 1.
FIG. 3 is a front view of the packing cube of FIG. 1.
FIG. 4 is a left side view of the packing cube of FIG. 1.
FIG. 5 is a right side view of the packing cube of FIG. 1.
FIG. 6 is a top view of the packing cube of FIG. 1.
FIG. 7 is a bottom view of the packing cube of FIG. 1.
FIG. 8 is a back view of a second embodiment of a packing cube.
FIG. 9 is a front view of the packing cube of FIG. 8.
FIG. 10 is a back view of a third embodiment of a packing cube; and,
FIG. 11 is a front view of the packing cube of FIG. 10.
The broken lines showing portions of the packing cube form no part of the claimed design.

1 Claim, 9 Drawing Sheets



(56)

References Cited

OTHER PUBLICATIONS

YAMIU Packing Cubes, available Jun. 6, 2017 [online], [site visited Dec. 17, 2021]. Available from internet, URL: <<https://www.amazon.com/YAMIU-Packing-Organizer-Accessories-Toiletry/dp/B071JR4F7X>> (Year: 2017).*

GOX Ultra Light 5 piece Packing Cubes, announced Jul. 27, 2017 [online], [site visited Dec. 17, 2021]. Available from internet, URL: <<https://www.amazon.com/GOX-Packing-Luggage-Organizers-Laundry/dp/B0749LXCXG>> (Year: 2017).*

* cited by examiner

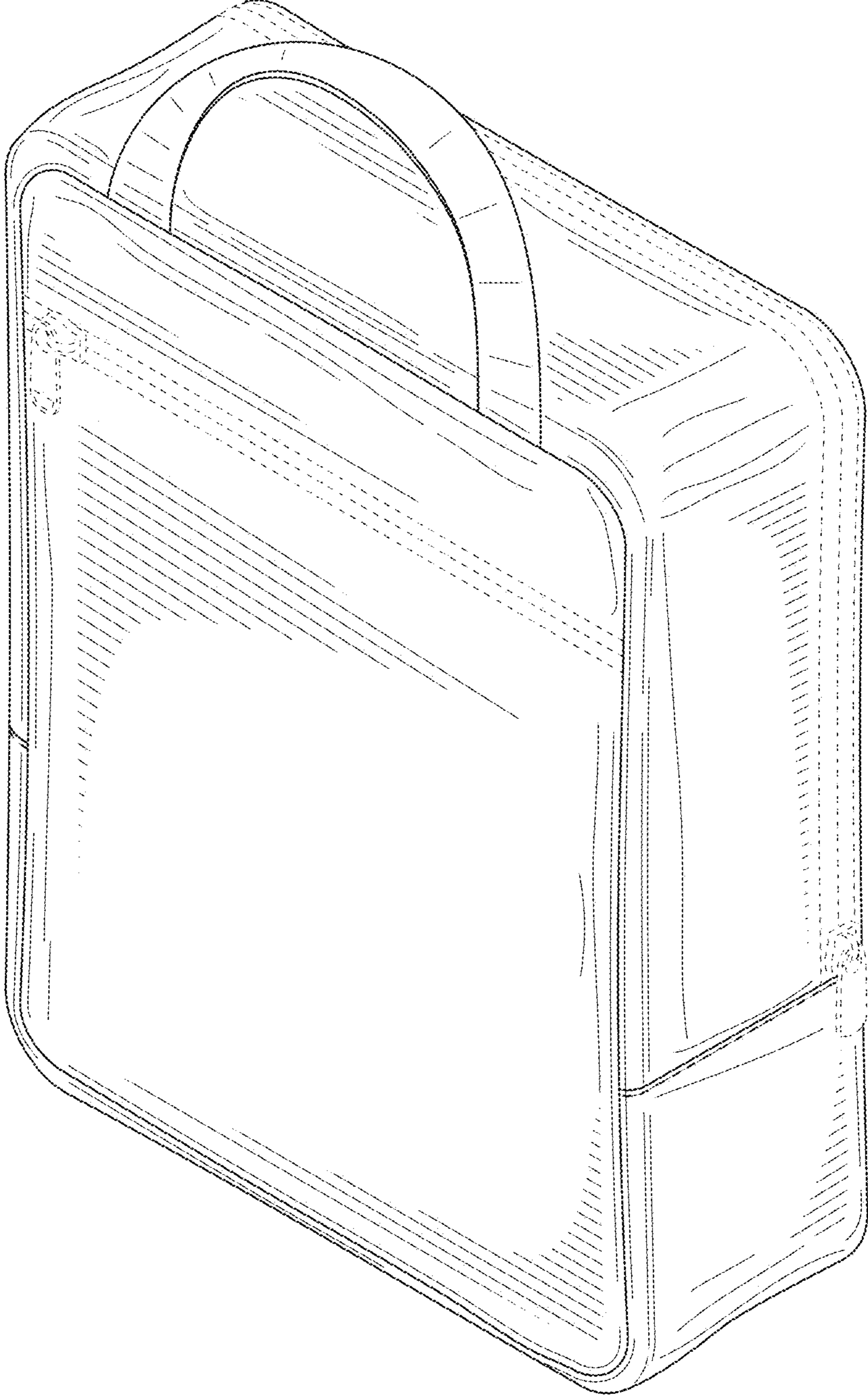

FIG. 1

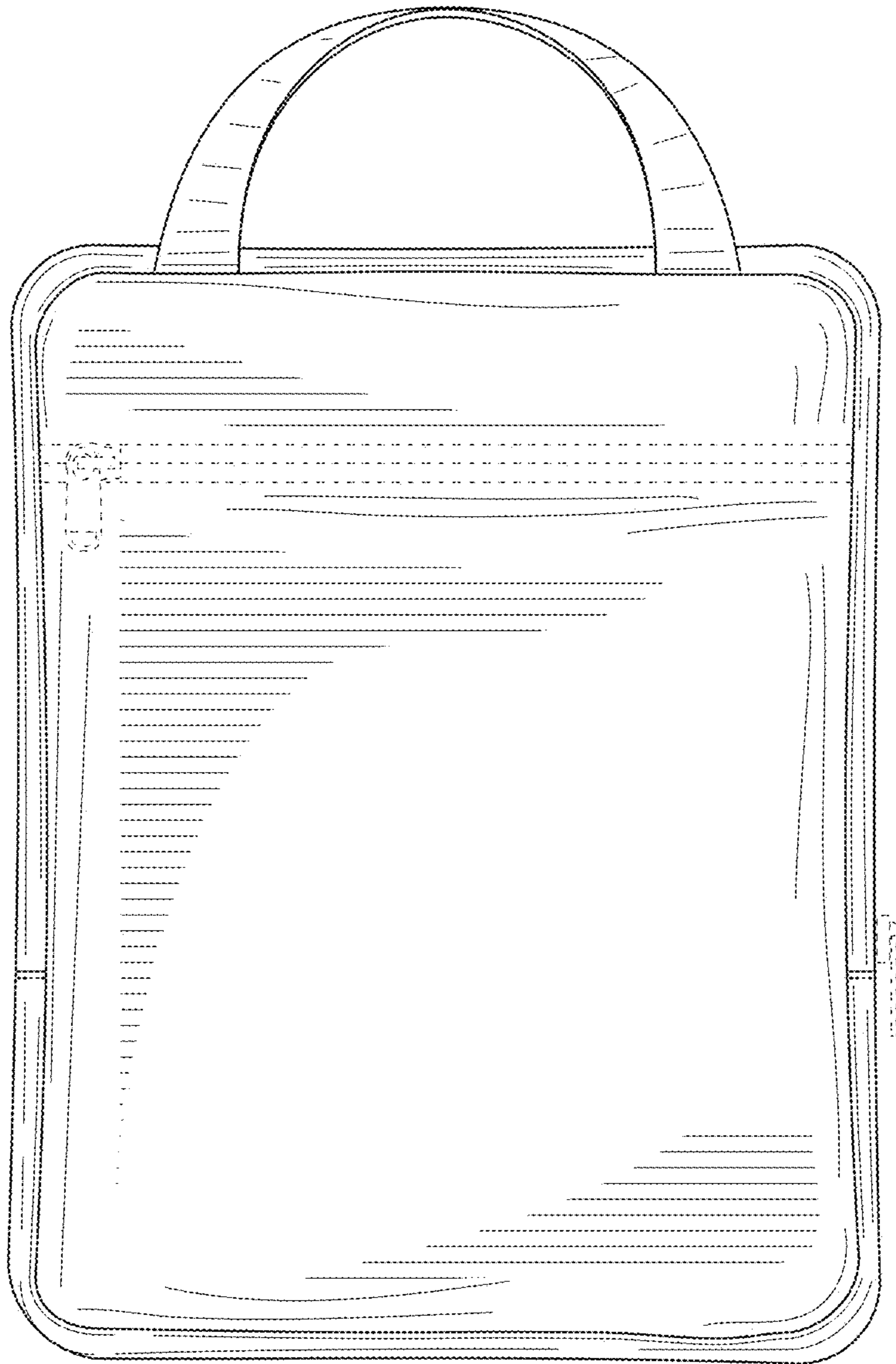

FIG. 2

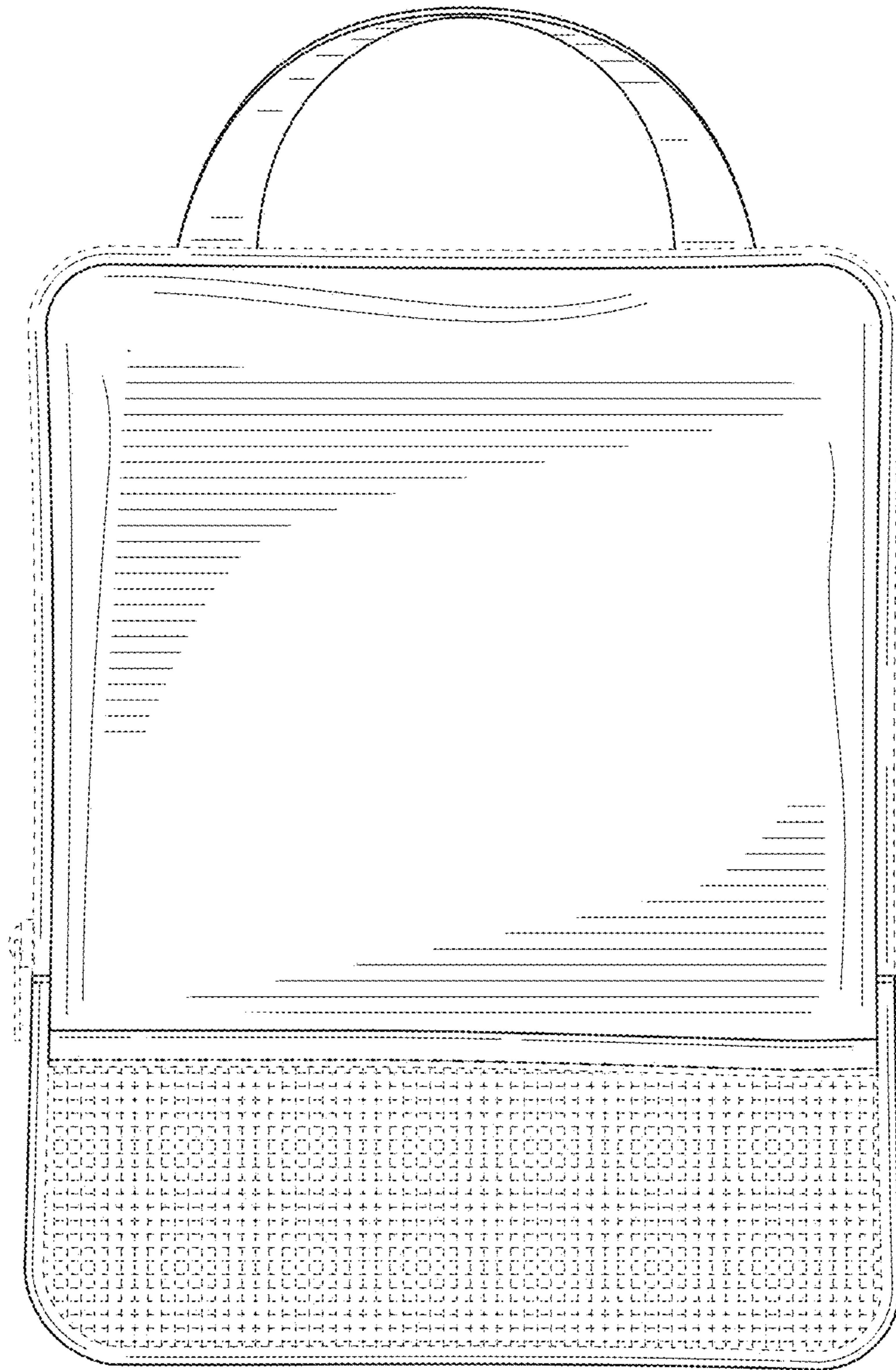

FIG. 3

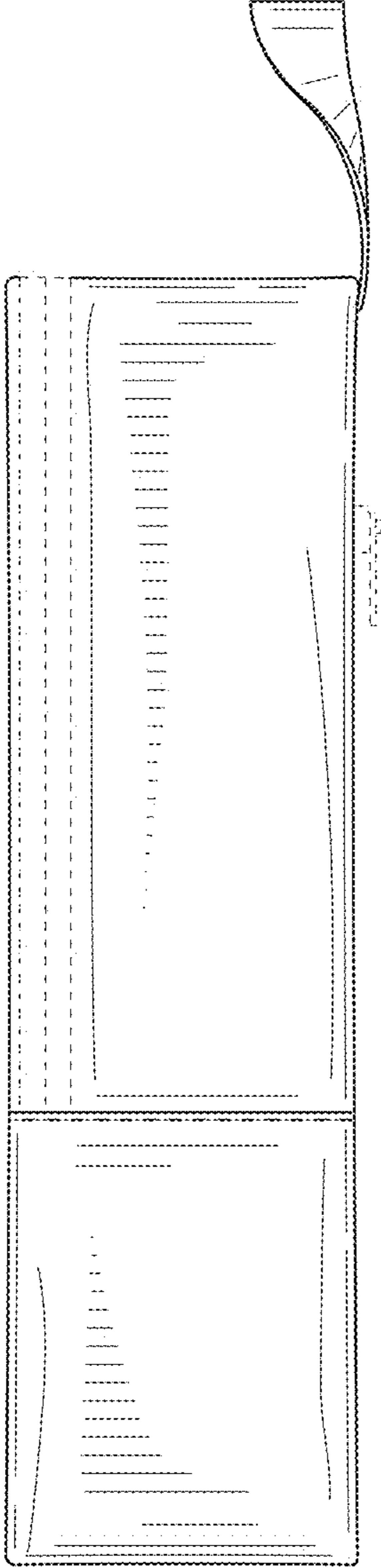

FIG. 4

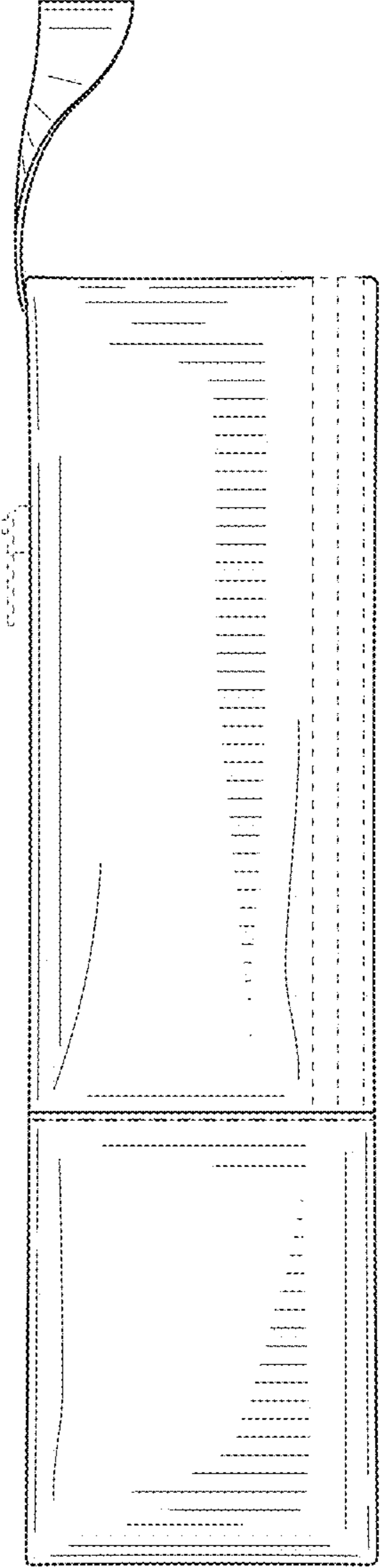

FIG. 5

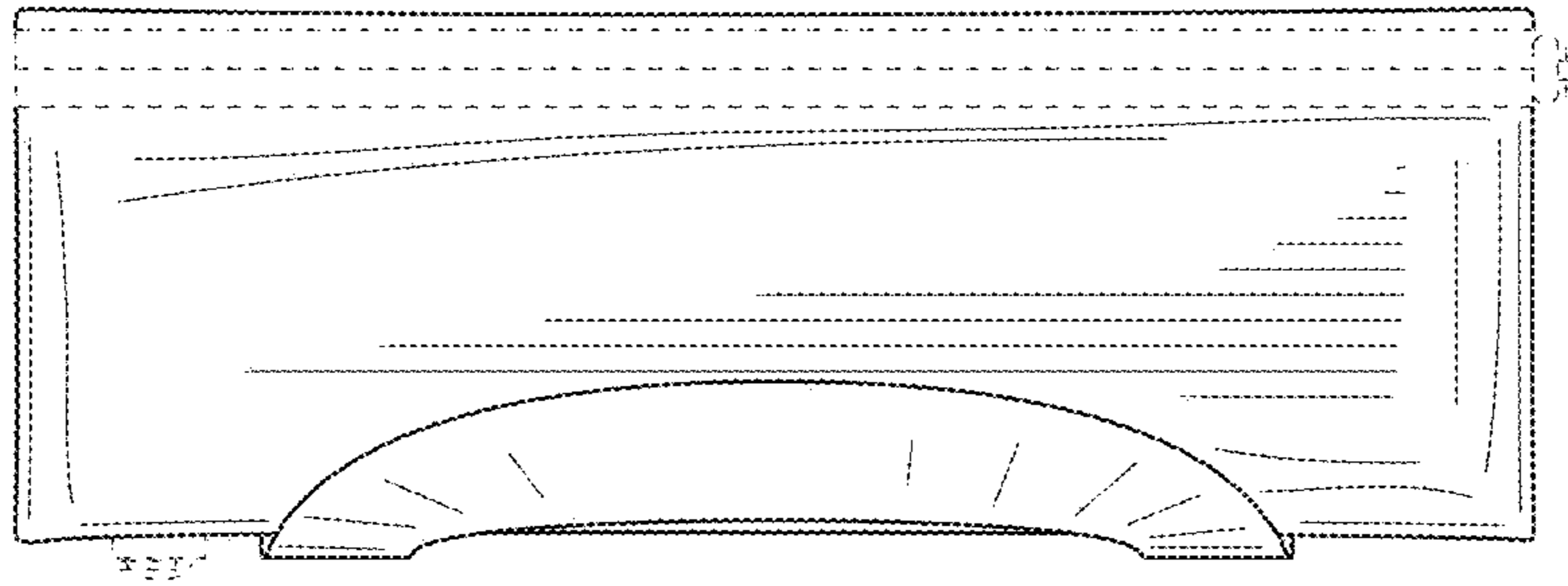

FIG. 6

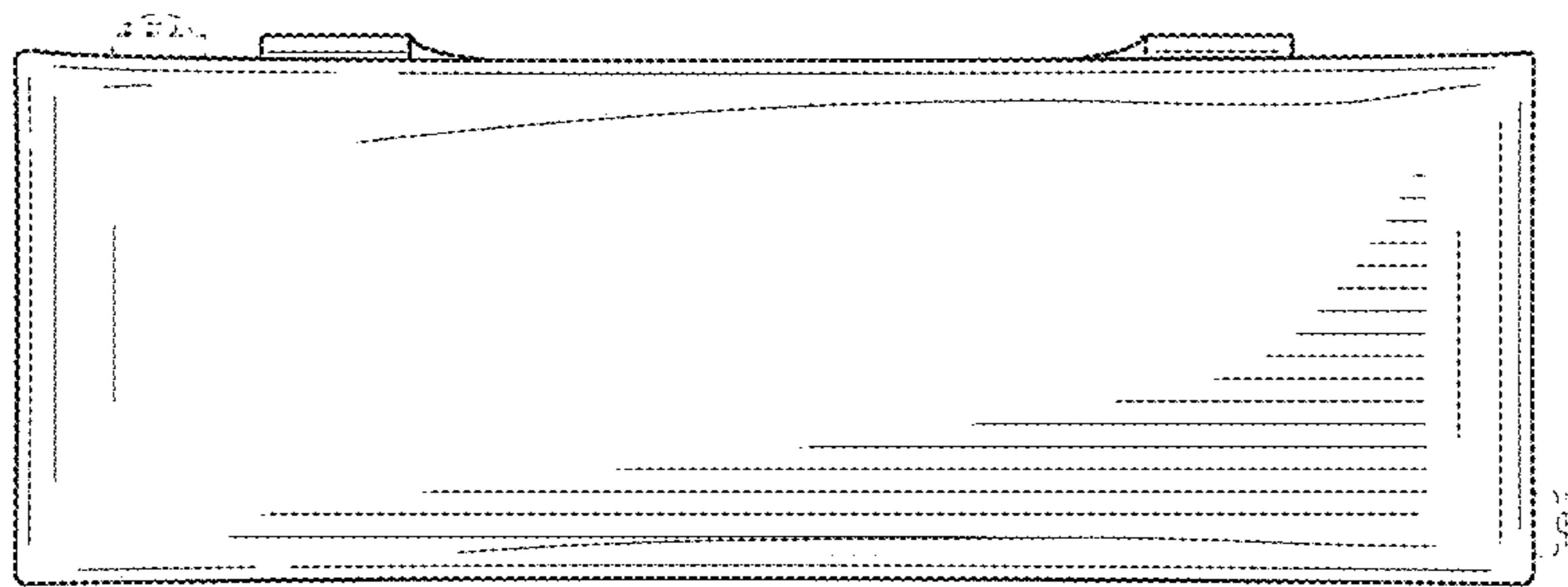

FIG. 7

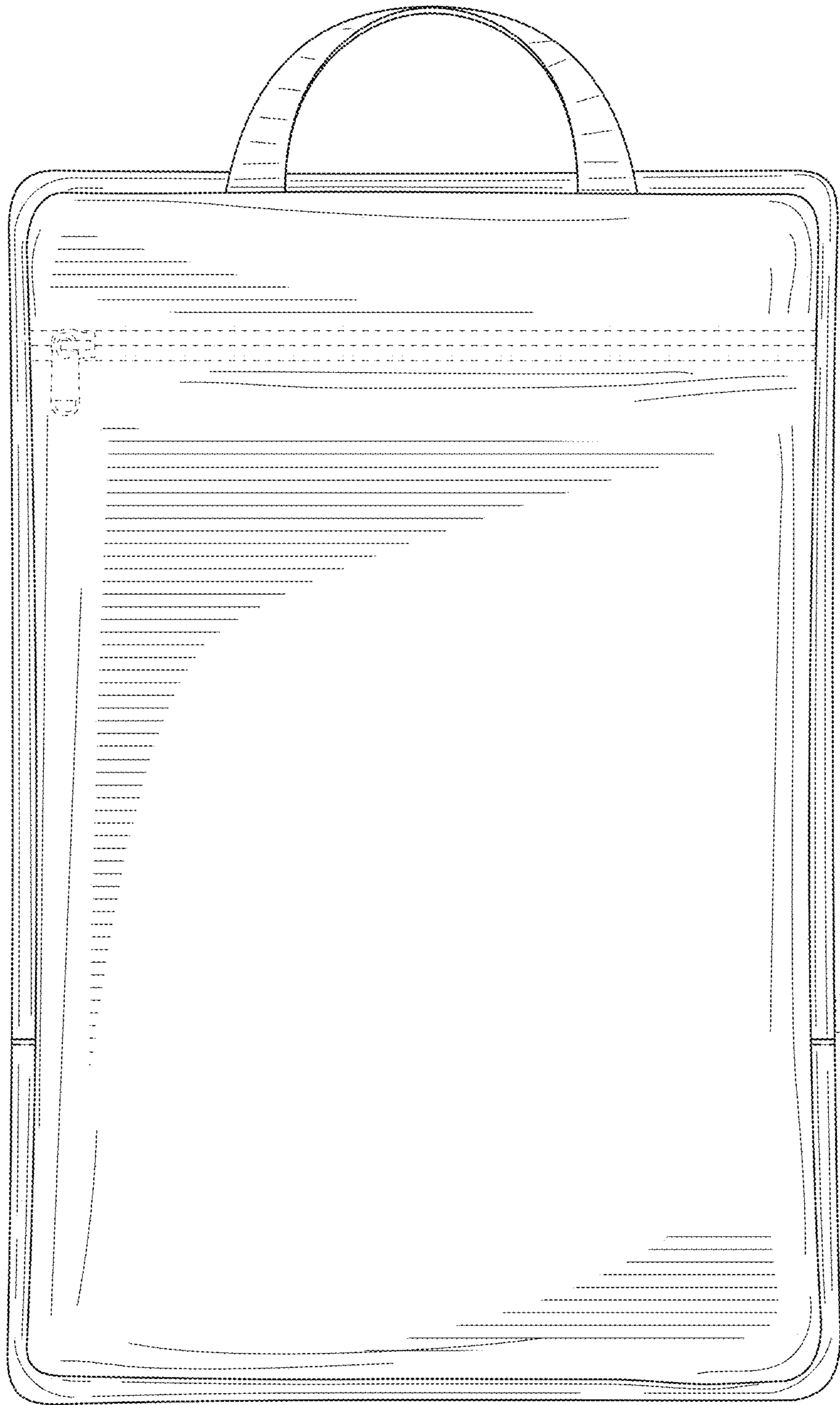

FIG. 8

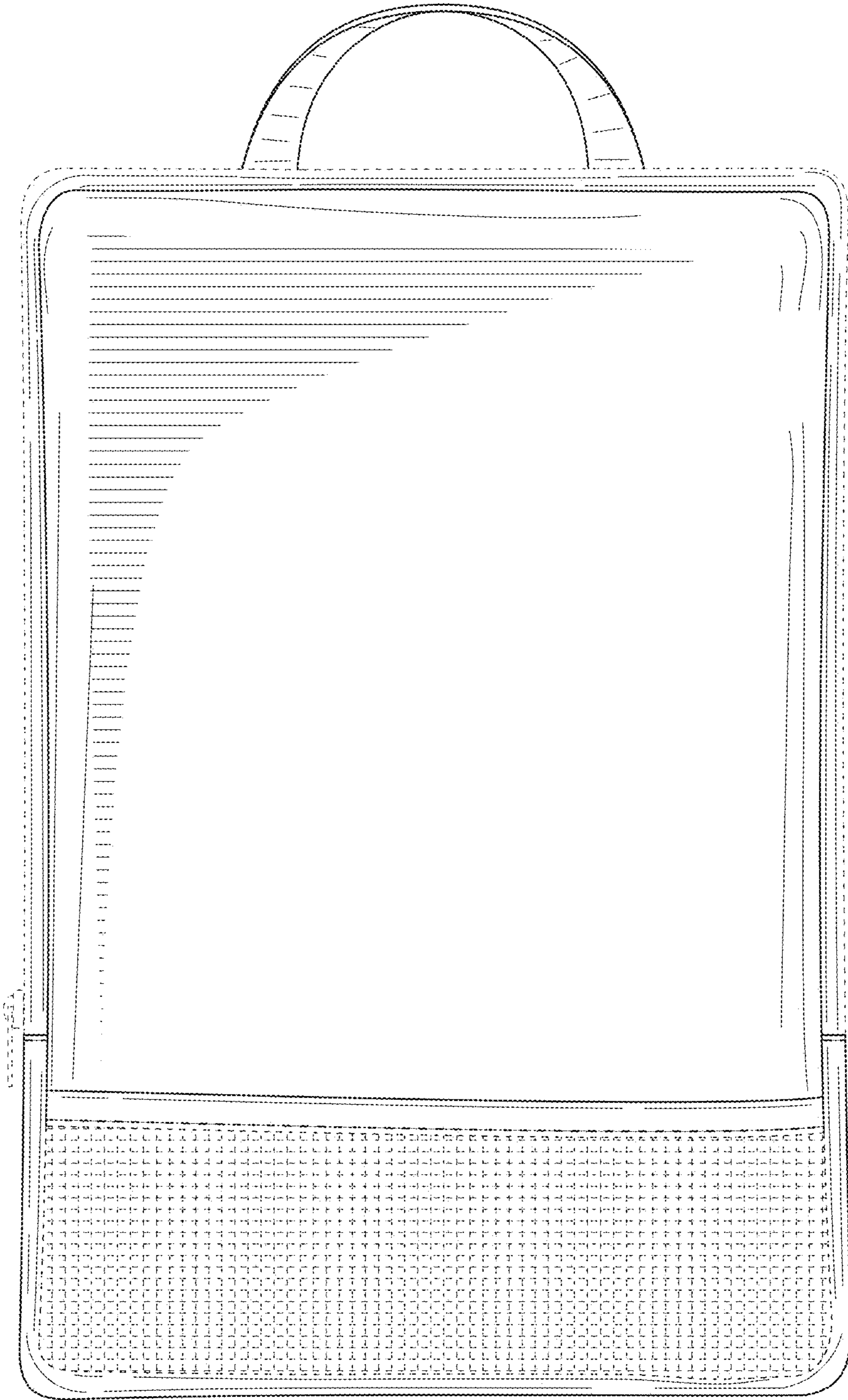

FIG. 9

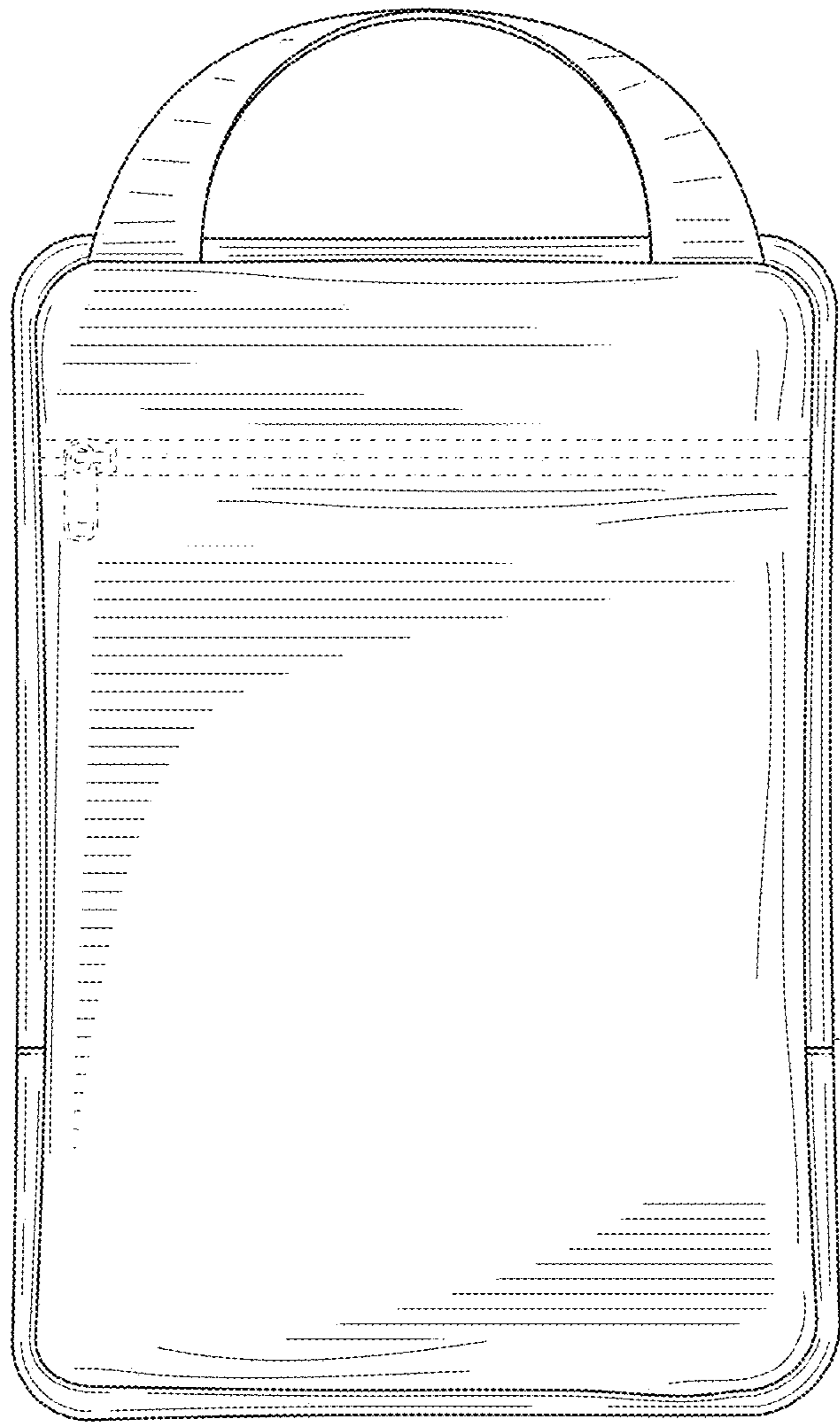

FIG. 10

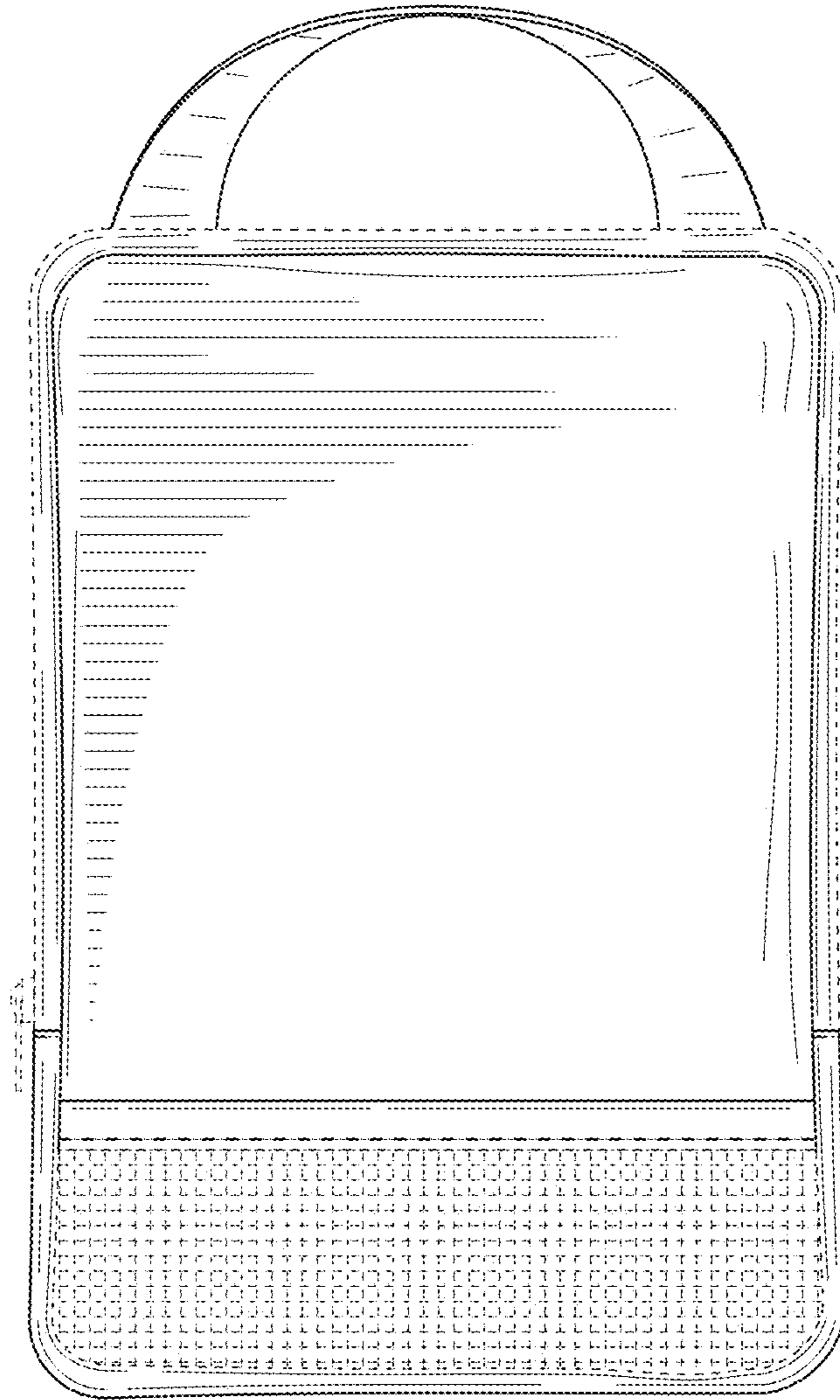

FIG. 11