



US00D944968S

(12) **United States Design Patent** (10) **Patent No.:** **US D944,968 S**
Gorali (45) **Date of Patent:** **** *Mar. 1, 2022**

(54) **CEILING FAN**
(71) Applicant: **Yuval Shimon Gorali**, Tel Aviv (IL)
(72) Inventor: **Yuval Shimon Gorali**, Tel Aviv (IL)
(*) Notice: This patent is subject to a terminal disclaimer.
(**) Term: **15 Years**

(21) Appl. No.: **35/509,736**
(22) Filed: **Jan. 3, 2020**

(80) **Hague Agreement Data**
Int. Filing Date: **Jan. 3, 2020**
Int. Reg. No.: **DM/208450**
Int. Reg. Date: **Jan. 3, 2020**
Int. Reg. Pub. Date: **Jul. 3, 2020**

(51) **LOC (13) Cl.** **23-03**
(52) **U.S. Cl.**
USPC **D23/411**
(58) **Field of Classification Search**
USPC D23/370-385, 411-414; D13/179
CPC F04D 25/088; F04D 25/06; F04D 29/38;
F04D 29/522; F04D 29/5853; F04D
29/326; F01P 5/02
See application file for complete search history.

(56) **References Cited**
U.S. PATENT DOCUMENTS

| | | | | | |
|------------|---|---------|-----------|-------|---------|
| D516,201 S | * | 2/2006 | Badarello | | D23/411 |
| D580,545 S | * | 11/2008 | Pickett | | D23/411 |
| D584,810 S | * | 1/2009 | Pickett | | D23/411 |
| D598,997 S | * | 8/2009 | Klausing | | D23/377 |
| D782,025 S | * | 3/2017 | Pickett | | D23/411 |
| D799,661 S | * | 10/2017 | Holmes | | D23/385 |
| D872,252 S | * | 1/2020 | McRoberts | | D23/377 |

| | | | | | |
|------------|---|--------|-----------|-------|---------|
| D874,635 S | * | 2/2020 | Holmes | | D23/377 |
| D877,882 S | * | 3/2020 | Holmes | | D23/411 |
| D882,059 S | * | 4/2020 | McRoberts | | D23/377 |
| D884,867 S | * | 5/2020 | Gobber | | D23/366 |
| D885,551 S | * | 5/2020 | McRoberts | | D23/377 |
| D886,979 S | * | 6/2020 | Gorali | | D23/377 |
| D914,191 S | * | 3/2021 | Gorali | | D23/411 |
| D918,376 S | * | 5/2021 | Schulzman | | D23/411 |
| D921,881 S | * | 6/2021 | Haggar | | D23/411 |

* cited by examiner

Primary Examiner — Natasha Vujcic
(74) *Attorney, Agent, or Firm* — Vorys. Sater, Seymour and Pease LLP; William L. Klima

(57) **CLAIM**

The ornamental design for a ceiling fan, as shown and described.

DESCRIPTION

The patent or application file contains at least one drawing executed in color. Copies of this patent or patent application publication with color drawing(s) will be provided by the Office upon request and payment of the necessary fee.

1. Ceiling fan
 - 1.1 : Front
 - 1.2 : Left
 - 1.3 : Perspective
 - 1.4 : Perspective
 - 1.5 : Perspective
 - 1.6 : Bottom
 - 1.7 : Top

The portions colored with orange form no part of the claimed design; the right side view is omitted because it is a mirror image of the left side view; 1.1: front; 1.2: left; 1.3: perspective (front, bottom, left); 1.4: perspective (front, top, left); 1.5: perspective (rear, bottom, right); 1.6: bottom; 1.7: top.

1 Claim, 7 Drawing Sheets
(7 of 7 Drawing Sheet(s) Filed in Color)

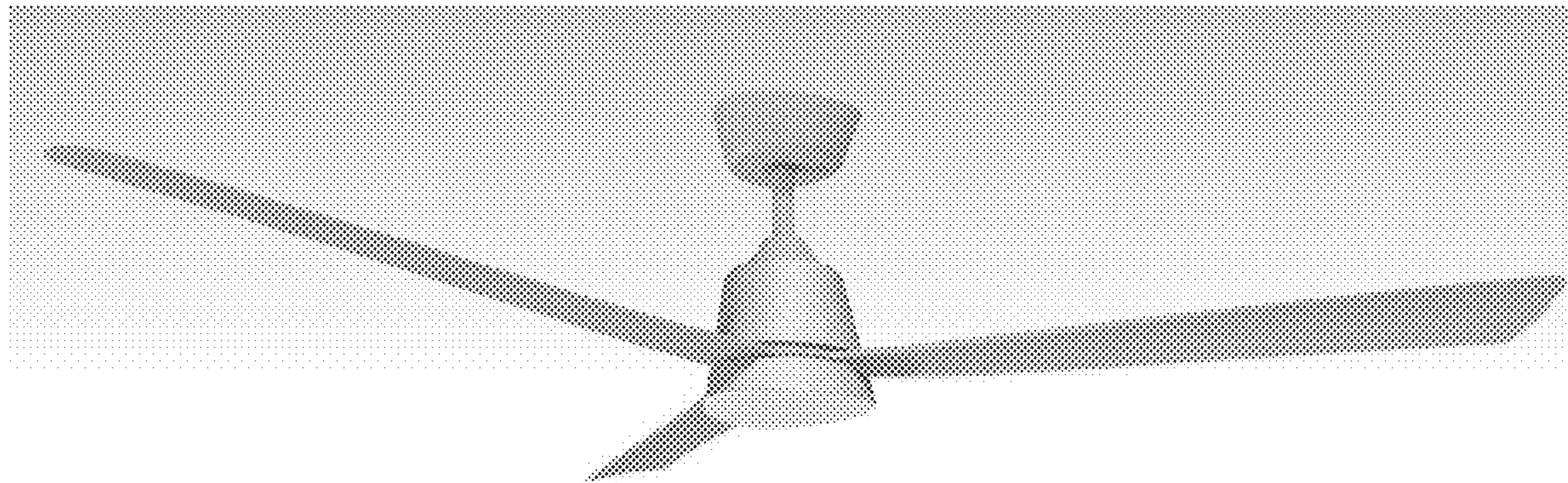

1.1

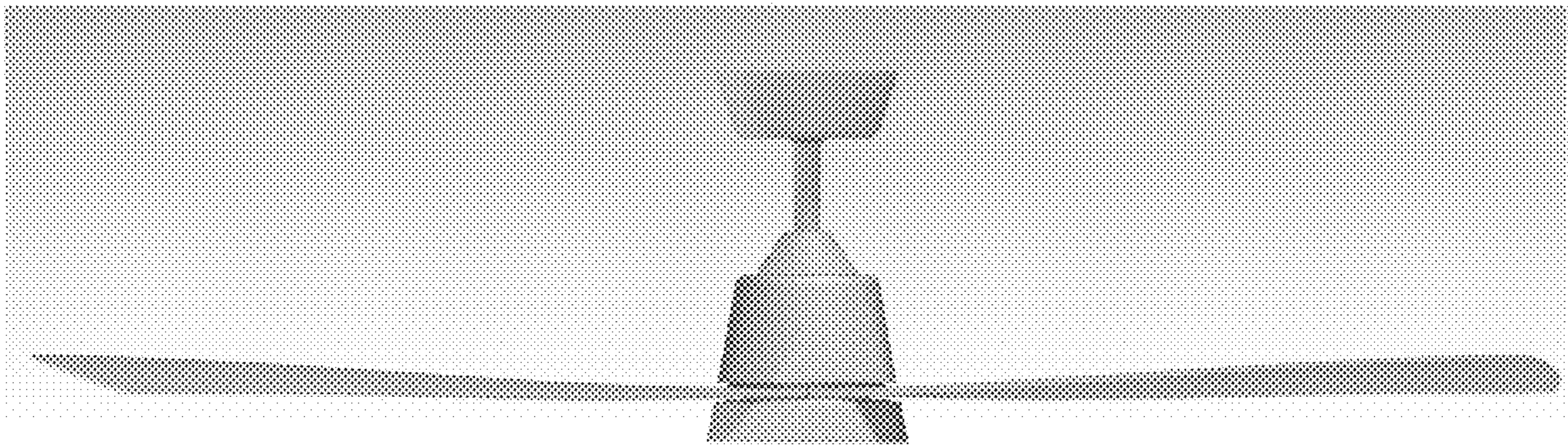

1.2

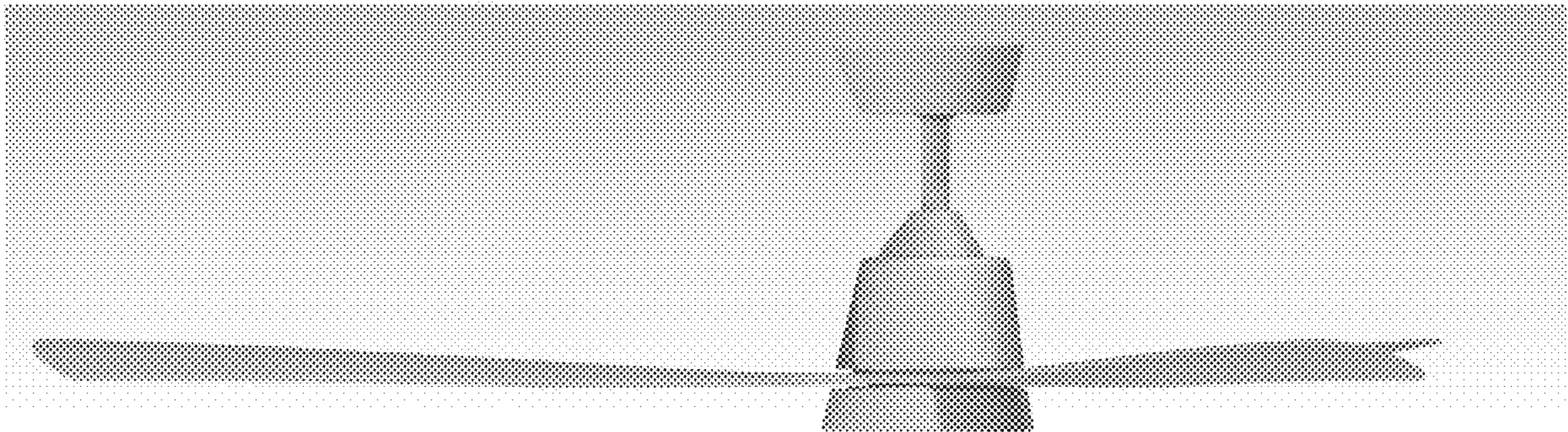

1.3

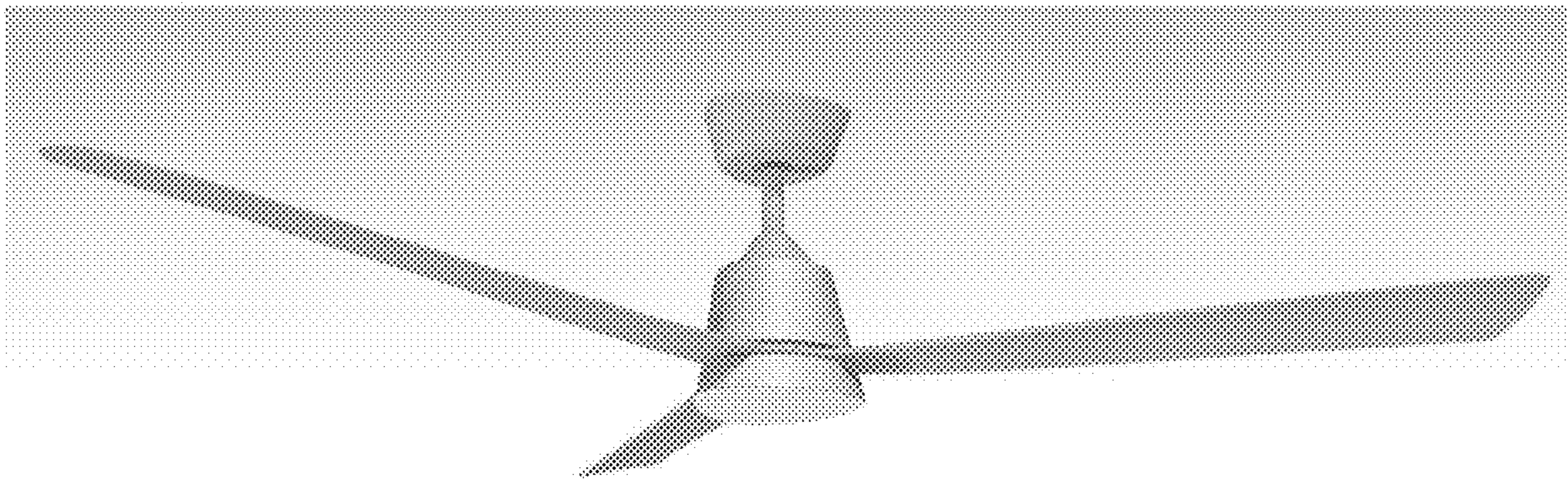

1.4

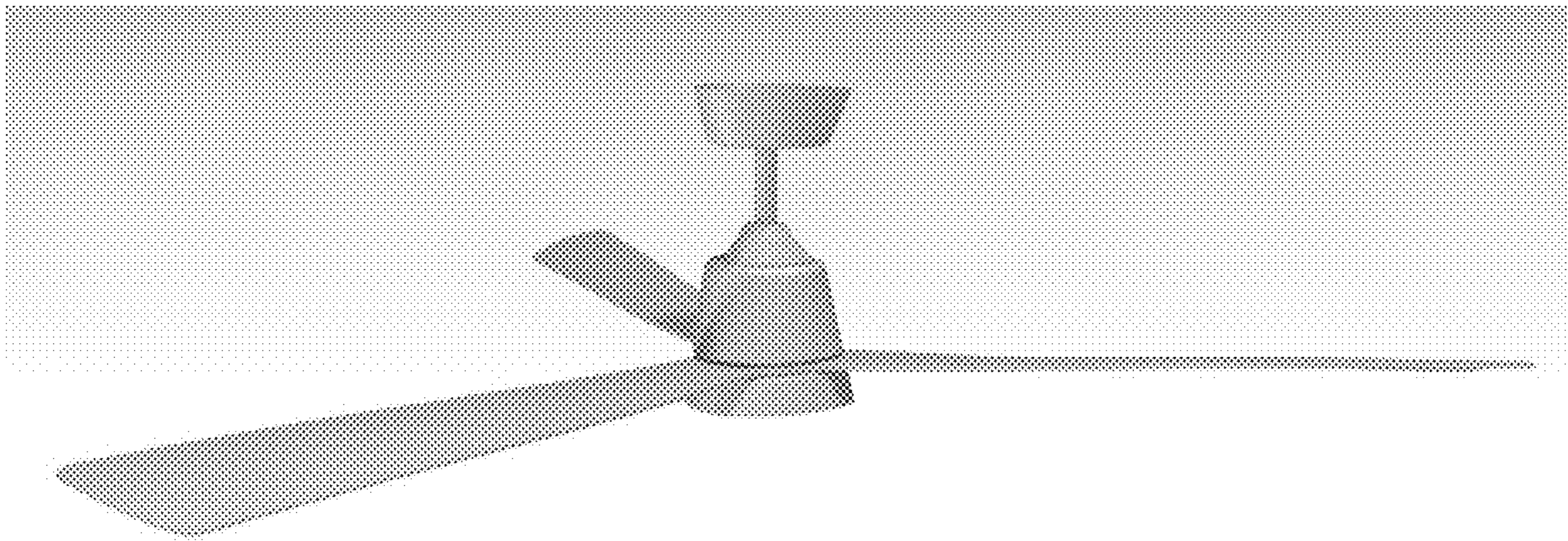

1.5

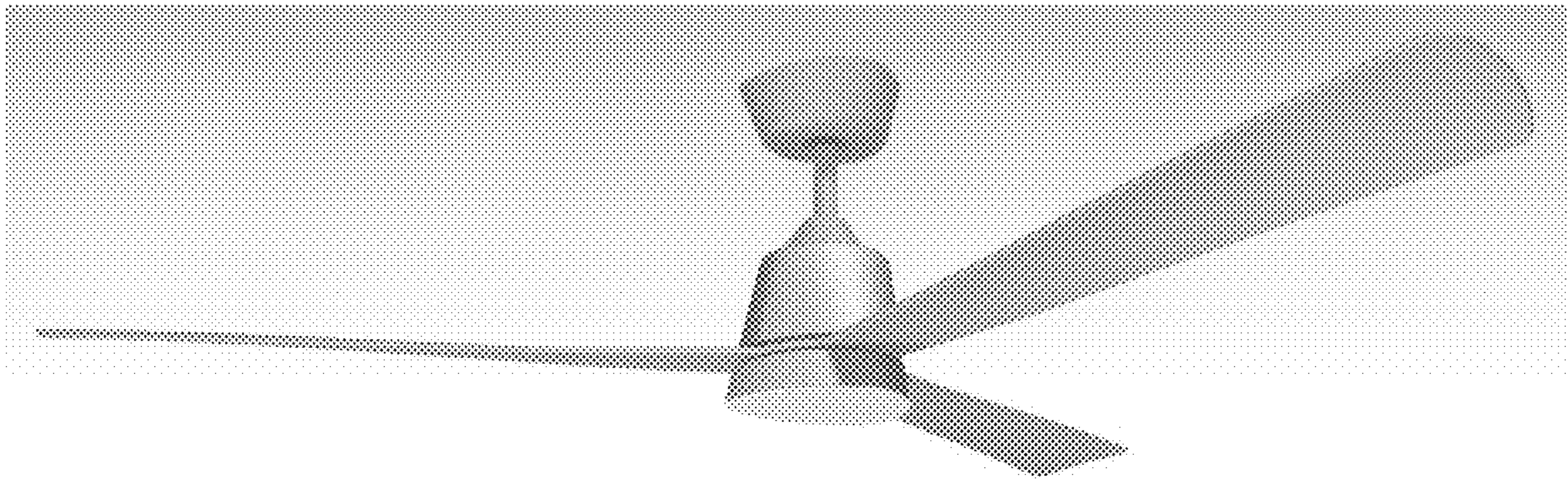

1.6

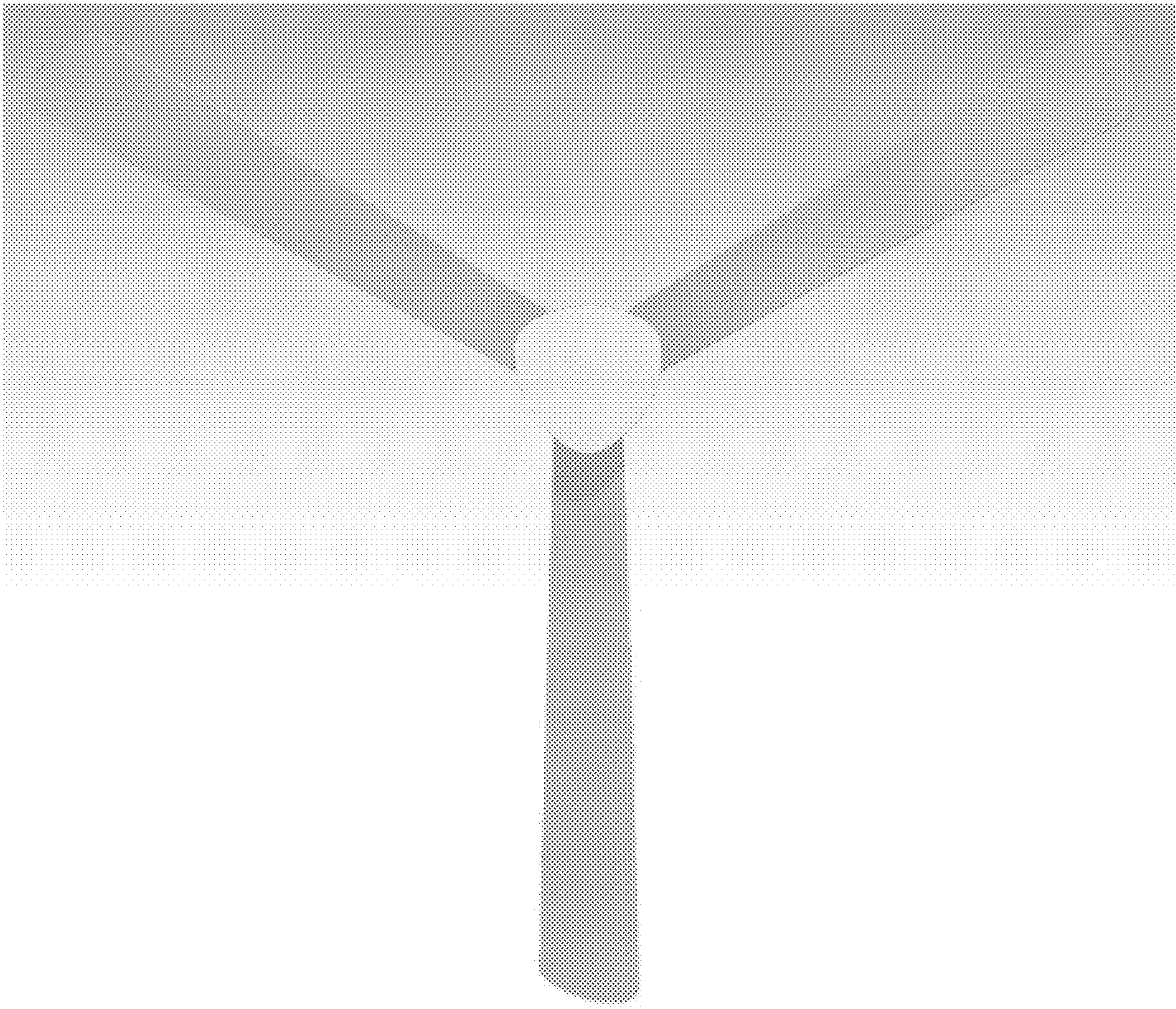

1.7

