



US00D944946S

(12) **United States Design Patent** (10) **Patent No.:** **US D944,946 S**
Adachi et al. (45) **Date of Patent:** **** *Mar. 1, 2022**

(54) **SHOWER PLATE**

FOREIGN PATENT DOCUMENTS

(71) Applicant: **ASM IP Holding B.V.**, Almere (NL)
(72) Inventors: **Wataru Adachi**, Kawasaki (JP);
Takafumi Hisamitsu, Sagamihara (JP)

AT 520629 6/2019
CN 1186873 7/1998
(Continued)

(73) Assignee: **ASM IP Holding B.V.**, Almere (NL)

OTHER PUBLICATIONS

(*) Notice: This patent is subject to a terminal disclaimer.

CNIPA; Notice of Allowance dated Dec. 27, 2019 in Application No. 201510765406.3.

(Continued)

(**) Term: **15 Years**

Primary Examiner — Amy C Wierenga

(21) Appl. No.: **29/695,044**

(74) *Attorney, Agent, or Firm* — Snell & Wilmer L.L.P.

(22) Filed: **Jun. 14, 2019**

(51) **LOC (13) Cl.** **23-01**

(57) **CLAIM**

(52) **U.S. Cl.**
USPC **D23/261**; D13/182

The ornamental design for a shower plate, as shown and described.

(58) **Field of Classification Search**
USPC D23/209–210, 233, 235, 259–261, 366;
D13/121, 154, 182; 118/728

See application file for complete search history.

DESCRIPTION

(56) **References Cited**

FIG. 1 is a perspective view of a shower plate showing a first embodiment of our new design;
FIG. 2 is a top plan view thereof;
FIG. 3 is a bottom plan view thereof;
FIG. 4 is a front elevational view thereof;
FIG. 5 is a rear elevational view thereof;
FIG. 6 is a right side elevational view thereof;
FIG. 7 is a left side elevational view thereof;
FIG. 8 is a perspective view of a shower plate showing a second embodiment of our new design;
FIG. 9 is a top plan view thereof;
FIG. 10 is a bottom plan view thereof;
FIG. 11 is a front elevational view thereof;
FIG. 12 is a rear elevational view thereof;
FIG. 13 is a right side elevational view thereof; and,
FIG. 14 is a left side elevational view thereof.

U.S. PATENT DOCUMENTS

D30,036 S	1/1899	Rhind
D31,889 S	11/1899	Gill
D56,051 S	8/1920	Cohn
2,059,480 A	11/1936	Obermaier
2,161,626 A	6/1939	Loughner et al.
2,240,163 A	4/1941	Pick
2,266,416 A	12/1941	Duclos
2,280,778 A	4/1942	Andersen
D142,841 S	11/1945	D'Algodt
2,410,420 A	11/1946	Bennett
2,441,253 A	5/1948	Sarver
2,480,557 A	8/1949	Cummins
2,563,931 A	8/1951	Harrison
2,660,061 A	11/1953	Lewis
2,745,640 A	5/1956	Cushman
2,847,320 A	8/1958	Bulloff

(Continued)

1 Claim, 10 Drawing Sheets

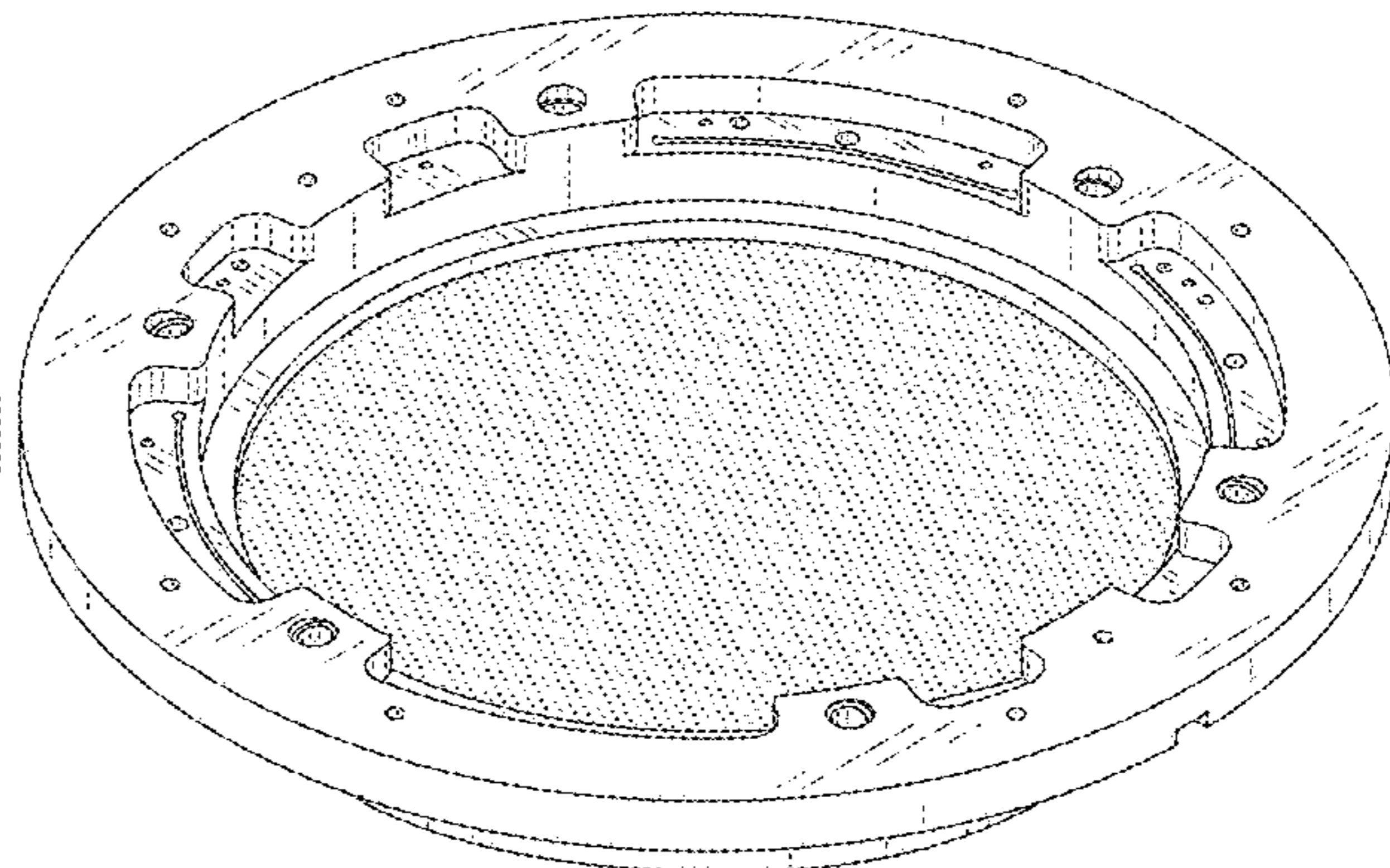
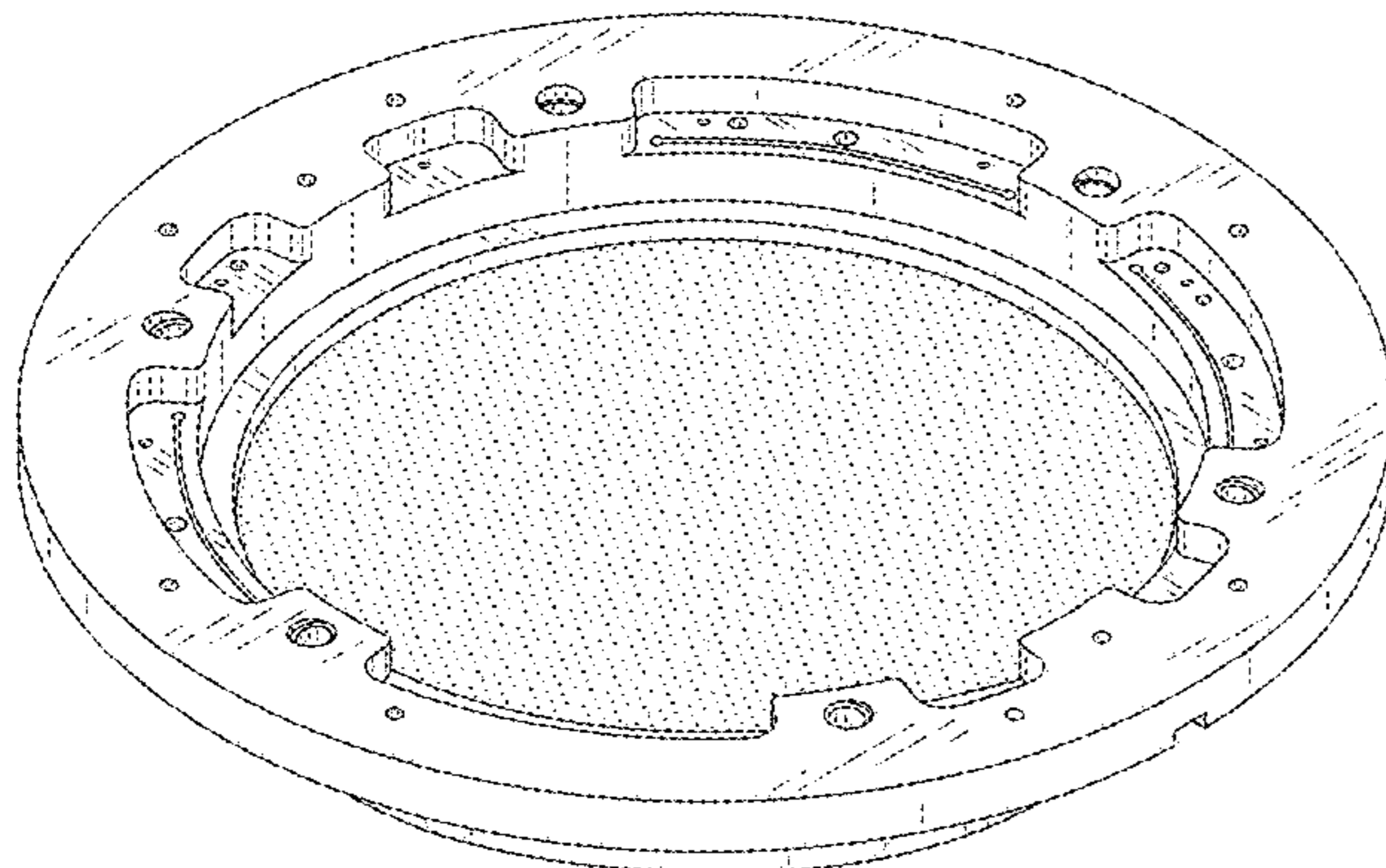

(56)

References Cited

U.S. PATENT DOCUMENTS

2,990,045 A	6/1961	Root	4,479,831 A	10/1984	Sandow
3,038,951 A	6/1962	Mead	4,480,284 A	10/1984	Tojo et al.
3,089,507 A	5/1963	Drake et al.	4,484,061 A	11/1984	Zelinka et al.
3,094,396 A	6/1963	Flugge et al.	4,488,506 A	12/1984	Heinecke et al.
3,197,682 A	7/1965	Klass et al.	4,495,024 A	1/1985	Bok
3,232,437 A	2/1966	Hultgren	4,496,828 A	1/1985	Kusmierz et al.
3,263,502 A	8/1966	Springfield	4,499,354 A	2/1985	Hill et al.
3,332,286 A	7/1967	Strong	4,502,094 A	2/1985	Lewin et al.
3,410,349 A	11/1968	Troutman	4,504,439 A	3/1985	Elter et al.
3,420,622 A	1/1969	Donges et al.	4,512,113 A	4/1985	Budinger
3,588,192 A	6/1971	Drutchas et al.	4,512,841 A	4/1985	Cunningham et al.
3,634,740 A	1/1972	Stevko	4,520,421 A	5/1985	Sakitani et al.
3,647,387 A	3/1972	Benson	4,527,005 A	7/1985	McKelvey et al.
3,647,716 A	3/1972	Koches	4,534,816 A	8/1985	Chen et al.
3,713,899 A	1/1973	Sebestyen	4,537,001 A	8/1985	Uppstrom
3,718,429 A	2/1973	Williamson	4,548,688 A	10/1985	Mathews
3,796,182 A	3/1974	Rosler	4,551,192 A	11/1985	Di Milia et al.
3,814,128 A	6/1974	Grantham	4,554,611 A	11/1985	Lewin
3,833,492 A	9/1974	Bollyky	4,560,590 A	12/1985	Bok
3,854,443 A	12/1974	Baerg	4,570,328 A	2/1986	Price et al.
3,862,397 A	1/1975	Anderson et al.	4,575,408 A	3/1986	Bok
3,867,205 A	2/1975	Schley	4,575,636 A	3/1986	Caprari
3,885,504 A	5/1975	Baermann	4,578,560 A	3/1986	Tanaka et al.
3,887,790 A	6/1975	Ferguson	4,579,080 A	4/1986	Martin et al.
3,904,371 A	9/1975	Neti	4,579,378 A	4/1986	Snyders
3,913,058 A	10/1975	Nishio et al.	4,579,623 A	4/1986	Suzuki et al.
3,913,617 A	10/1975	van Laar	4,581,520 A	4/1986	Vu et al.
3,916,270 A	10/1975	Wachtler et al.	4,590,326 A	5/1986	Woldy
3,947,685 A	3/1976	Meinel	4,611,966 A	9/1986	Johnson
3,960,559 A	6/1976	Suzuki	4,620,998 A	11/1986	Lalvani
3,962,004 A	6/1976	Sonneborn	4,622,918 A	11/1986	Bok
3,983,401 A	9/1976	Livesay	4,624,728 A	11/1986	Bithell et al.
3,997,638 A	12/1976	Manning et al.	D288,556 S	3/1987	Wallgren
4,048,110 A	9/1977	Vanderspurt	4,653,541 A	3/1987	Oehlschlaeger et al.
4,054,071 A	10/1977	Patejak	4,654,226 A	3/1987	Jackson et al.
4,058,430 A	11/1977	Suntola et al.	4,655,592 A	4/1987	Allemand
4,079,944 A	3/1978	Durley et al.	4,662,987 A	5/1987	Bok
4,093,491 A	6/1978	Whelpton et al.	4,664,769 A	5/1987	Cuomo et al.
4,099,041 A	7/1978	Berkman et al.	4,670,126 A	6/1987	Messer et al.
D249,341 S	9/1978	Mertz	4,681,134 A	7/1987	Paris
4,126,027 A	11/1978	Smith et al.	4,693,211 A	9/1987	Ogami et al.
4,134,425 A	1/1979	Gussefeld et al.	4,700,089 A	10/1987	Fujii et al.
4,145,699 A	3/1979	Hu et al.	4,707,815 A	11/1987	Yamasaki
4,149,237 A	4/1979	Freitas	4,717,461 A	1/1988	Strahl et al.
4,152,760 A	5/1979	Freitas et al.	4,718,637 A	1/1988	Contin
4,157,751 A	6/1979	Grundken et al.	4,720,407 A	1/1988	Sculke
4,164,959 A	8/1979	Wurzburger	4,721,533 A	1/1988	Phillippi et al.
4,176,630 A	12/1979	Elmer	4,721,534 A	1/1988	Phillippi et al.
4,179,530 A	12/1979	Koppl et al.	4,722,298 A	2/1988	Rubin et al.
4,181,330 A	1/1980	Kojima	4,724,272 A	2/1988	Raniere et al.
4,184,188 A	1/1980	Briglia	4,725,204 A	2/1988	Powell
4,194,536 A	3/1980	Stine et al.	4,735,259 A	4/1988	Vincent
4,217,463 A	8/1980	Swearingen	4,738,618 A	4/1988	Massey et al.
4,229,064 A	10/1980	Vetter et al.	4,738,748 A	4/1988	Kisa
4,234,449 A	11/1980	Wolson et al.	4,747,367 A	5/1988	Posa
4,314,763 A	2/1982	Steigmeier et al.	4,749,416 A	6/1988	Greenspan
4,322,592 A	3/1982	Martin	4,750,520 A	6/1988	Heim et al.
4,324,611 A	4/1982	Vogel et al.	4,753,192 A	6/1988	Goldsmith et al.
4,333,735 A	6/1982	Hardy	4,753,856 A	6/1988	Haluska et al.
4,355,912 A	10/1982	Haak	4,756,794 A	7/1988	Yoder
4,384,918 A	5/1983	Abe	4,764,076 A	8/1988	Layman et al.
4,389,973 A	6/1983	Suntola et al.	4,770,590 A	9/1988	Hugues et al.
D269,850 S	7/1983	Preisler et al.	4,771,015 A	9/1988	Kanai
4,393,013 A	7/1983	McMenamin	4,775,281 A	10/1988	Prentakis
4,401,507 A	8/1983	Engle	4,776,744 A	10/1988	Stonestreet et al.
4,412,133 A	10/1983	Eckes et al.	4,780,169 A	10/1988	Stark et al.
4,413,022 A	11/1983	Suntola et al.	4,781,511 A	11/1988	Harada et al.
4,414,492 A	11/1983	Hanlet	4,789,294 A	12/1988	Sato et al.
4,436,674 A	3/1984	McMenamin	4,790,258 A	12/1988	Drage et al.
4,444,990 A	4/1984	Villar	4,802,441 A	2/1989	Waugh
D274,122 S	6/1984	Stahel et al.	4,808,387 A	2/1989	Datta et al.
4,454,370 A	6/1984	Voznick	4,812,201 A	3/1989	Sakai et al.
4,455,193 A	6/1984	Jeuch et al.	4,812,217 A	3/1989	George et al.
4,465,716 A	8/1984	Baber et al.	4,821,674 A	4/1989	deBoer et al.
4,466,766 A	8/1984	Geren et al.	4,827,430 A	5/1989	Aid et al.
			4,828,224 A	5/1989	Crabb et al.
			4,830,515 A	5/1989	Cortes
			4,837,113 A	6/1989	Luttmer et al.
			4,837,185 A	6/1989	Yau et al.

(56)

References Cited

U.S. PATENT DOCUMENTS

4,854,263 A	8/1989	Chang et al.	5,158,128 A	10/1992	Inoue et al.
4,854,266 A	8/1989	Simson et al.	D330,900 S	11/1992	Wakegijig
4,857,137 A	8/1989	Tachi et al.	5,167,716 A	12/1992	Boitnott et al.
4,857,382 A	8/1989	Liu et al.	5,167,761 A	12/1992	Westendorp et al.
4,858,557 A	8/1989	Pozzetti et al.	5,174,881 A	12/1992	Iwasaki et al.
4,863,374 A	9/1989	Vukovich	5,176,451 A	1/1993	Sasada
4,867,629 A	9/1989	Iwasawa et al.	5,178,639 A	1/1993	Nishi
4,871,523 A	10/1989	Datta et al.	5,178,682 A	1/1993	Tsukamoto et al.
4,874,273 A	10/1989	Tokisue et al.	5,180,273 A	1/1993	Sakaya et al.
4,882,199 A	11/1989	Sadoway et al.	5,180,435 A	1/1993	Markunas et al.
4,886,162 A	12/1989	Ambrogio	5,181,779 A	1/1993	Shia et al.
4,916,091 A	4/1990	Freeman et al.	5,182,232 A	1/1993	Chhabra et al.
4,917,556 A	4/1990	Stark et al.	5,183,511 A	2/1993	Yamazaki et al.
4,920,918 A	5/1990	Adams et al.	D333,606 S	3/1993	Kanemitsu et al.
4,925,388 A	5/1990	Iseki et al.	5,192,717 A	3/1993	Kawakami
4,931,135 A	6/1990	Horiuchi et al.	5,193,912 A	3/1993	Saunders
4,934,831 A	6/1990	Volbrecht	5,193,969 A	3/1993	Rush et al.
4,938,815 A	7/1990	McNeilly	5,194,401 A	3/1993	Adams et al.
D309,702 S	8/1990	Hall	5,199,603 A	4/1993	Prescott
4,949,848 A	8/1990	Kos	5,208,961 A	5/1993	Lajoie
4,950,624 A	8/1990	Inuzima et al.	5,213,650 A	5/1993	Wang et al.
4,956,538 A	9/1990	Moslehi	5,221,556 A	6/1993	Hawkins et al.
4,958,061 A	9/1990	Wakabayashi et al.	5,225,366 A	7/1993	Yoder
D311,126 S	10/1990	Crowley	5,226,383 A	7/1993	Bhat
4,962,063 A	10/1990	Maydan et al.	5,226,713 A	7/1993	Matsumura
4,976,996 A	12/1990	Monkowski et al.	5,226,967 A	7/1993	Chen et al.
4,978,567 A	12/1990	Miller	5,228,114 A	7/1993	Suzuki
4,984,904 A	1/1991	Nakano et al.	5,232,508 A	8/1993	Arena et al.
4,985,114 A	1/1991	Okudaira	5,234,526 A	8/1993	Chen et al.
4,986,215 A	1/1991	Yamada	5,242,501 A	9/1993	McDiarmid
4,987,102 A	1/1991	Nguyen et al.	5,242,539 A	9/1993	Kumihashi et al.
4,987,856 A	1/1991	Hey	5,243,195 A	9/1993	Nishi
4,989,992 A	2/1991	Piai	5,243,202 A	9/1993	Mori et al.
4,991,614 A	2/1991	Hammel	5,246,218 A	9/1993	Yap et al.
5,002,632 A	3/1991	Loewenstein et al.	5,246,500 A	9/1993	Samata et al.
5,013,691 A	5/1991	Lory et al.	5,249,960 A	10/1993	Monoe
5,022,961 A	6/1991	Izumi et al.	5,259,881 A	11/1993	Edwards et al.
5,027,746 A	7/1991	Frijlink	5,261,167 A	11/1993	Sakata
5,028,366 A	7/1991	Harakal et al.	5,266,526 A	11/1993	Aoyama
D320,148 S	9/1991	Andrews	5,268,989 A	12/1993	Moslehi et al.
5,049,029 A	9/1991	Mitsui et al.	5,271,967 A	12/1993	Kramer et al.
5,053,247 A	10/1991	Moore	5,273,609 A	12/1993	Moslehi
5,057,436 A	10/1991	Ball	5,277,932 A	1/1994	Spencer
5,060,322 A	10/1991	Delepine	5,278,494 A	1/1994	Obigane
5,061,083 A	10/1991	Grimm et al.	5,279,886 A	1/1994	Kawai et al.
5,062,386 A	11/1991	Christensen	5,279,986 A	1/1994	Maloney et al.
5,064,337 A	11/1991	Asakawa et al.	5,280,894 A	1/1994	Witcraft et al.
5,065,698 A	11/1991	Koike	5,281,274 A	1/1994	Yoder
5,067,437 A	11/1991	Watanabe et al.	5,284,519 A	2/1994	Gadgil
5,069,591 A	12/1991	Kinoshita	5,288,684 A	2/1994	Yamazaki et al.
5,071,258 A	12/1991	Usher et al.	5,294,572 A	3/1994	Granneman et al.
5,074,017 A	12/1991	Toya et al.	5,294,778 A	3/1994	Carman et al.
5,082,517 A	1/1992	Moslehi	5,298,089 A	3/1994	Bowe et al.
5,084,126 A	1/1992	McKee	5,305,417 A	4/1994	Najm et al.
5,088,444 A	2/1992	Ohmine et al.	5,306,666 A	4/1994	Izumi
5,097,890 A	3/1992	Nakao	5,306,946 A	4/1994	Yamamoto
5,098,638 A	3/1992	Sawada	5,308,650 A	5/1994	Krummel et al.
5,098,865 A	3/1992	Machado	5,310,410 A	5/1994	Begin et al.
5,104,514 A	4/1992	Quartarone	5,310,456 A	5/1994	Kadomura
5,107,170 A	4/1992	Ishikawa et al.	5,312,245 A	5/1994	Brannen et al.
5,108,192 A	4/1992	Mailliet et al.	5,313,061 A	5/1994	Drew et al.
5,110,407 A	5/1992	Ono et al.	5,314,538 A	5/1994	Maeda et al.
5,114,683 A	5/1992	Hirase	5,314,570 A	5/1994	Ikegaya et al.
5,116,018 A	5/1992	Friemoth et al.	5,315,092 A	5/1994	Takahashi et al.
5,117,121 A	5/1992	Watanabe et al.	5,320,218 A	5/1994	Takahashi et al.
D327,534 S	6/1992	Manville	5,326,427 A	6/1994	Yamashita et al.
5,119,760 A	6/1992	McMillan et al.	5,328,810 A	7/1994	Jerbic
5,124,272 A	6/1992	Saito et al.	5,328,810 A	7/1994	Lowrey et al.
5,125,358 A	6/1992	Ueda et al.	5,335,309 A	8/1994	Fujii et al.
5,125,710 A	6/1992	Gianelo	5,336,327 A	8/1994	Lee
5,130,003 A	7/1992	Conrad	5,338,362 A	8/1994	Imahashi
5,134,965 A	8/1992	Tokuda et al.	5,340,261 A	8/1994	Oosawa et al.
5,137,286 A	8/1992	Whitford	5,346,961 A	9/1994	Shaw et al.
5,151,296 A	9/1992	Tokunaga	5,348,774 A	9/1994	Golecki et al.
5,154,301 A	10/1992	Kos	5,350,480 A	9/1994	Gray
			5,354,433 A	10/1994	Granneman et al.
			5,354,580 A	10/1994	Goela et al.
			5,356,478 A	10/1994	Chen et al.
			5,356,672 A	10/1994	Schmitt et al.
			5,360,269 A	11/1994	Ogawa et al.

(56)

References Cited

U.S. PATENT DOCUMENTS

5,364,667 A	11/1994	Rhieu	5,583,736 A	12/1996	Anderson et al.
D353,452 S	12/1994	Groenhoff	5,584,936 A	12/1996	Pickering et al.
5,374,315 A	12/1994	Deboer et al.	5,586,585 A	12/1996	Bonora et al.
D354,898 S	1/1995	Nagy	5,589,002 A	12/1996	Su
5,380,367 A	1/1995	Bertone	5,589,110 A	12/1996	Motoda et al.
5,382,311 A	1/1995	Ishikawa et al.	5,595,606 A	1/1997	Fujikawa et al.
5,387,265 A	2/1995	Kakizaki et al.	5,601,641 A	2/1997	Stephens
5,388,945 A	2/1995	Garric et al.	5,602,060 A	2/1997	Kobayashi et al.
5,393,577 A	2/1995	Uesugi et al.	5,604,410 A	2/1997	Vollkommer et al.
5,397,395 A	3/1995	Sano et al.	5,611,448 A	3/1997	Chen
5,403,630 A	4/1995	Matsui et al.	5,616,264 A	4/1997	Nishi et al.
5,404,082 A	4/1995	Hernandez et al.	5,616,947 A	4/1997	Tamura
5,407,449 A	4/1995	Zinger	5,621,982 A	4/1997	Yamashita
5,407,867 A	4/1995	Iwasaki et al.	5,632,919 A	5/1997	MacCracken et al.
5,413,813 A	5/1995	Cruse et al.	D380,527 S	7/1997	Velez
5,414,221 A	5/1995	Gardner	5,645,646 A	7/1997	Beinglass et al.
5,415,753 A	5/1995	Hurwitt et al.	5,650,013 A	7/1997	Yamazaki
5,418,382 A	5/1995	Blackwood et al.	5,650,351 A	7/1997	Wu
5,421,893 A	6/1995	Perlov	5,653,807 A	8/1997	Crumbaker
5,422,139 A	6/1995	Fischer	5,656,093 A	8/1997	Burkhart et al.
5,423,942 A	6/1995	Robbins et al.	5,661,263 A	8/1997	Salvaggio
5,426,137 A	6/1995	Allen	5,662,470 A	9/1997	Huussen et al.
5,427,824 A	6/1995	Inushima et al.	5,663,899 A	9/1997	Zvonar et al.
5,430,011 A	7/1995	Tanaka et al.	5,665,608 A	9/1997	Chapple-Sokol et al.
5,431,734 A	7/1995	Chapple-Sokol et al.	5,667,592 A	9/1997	Boitnott et al.
5,443,646 A	8/1995	Yamada et al.	5,670,786 A	9/1997	Meyer et al.
5,443,648 A	8/1995	Ohkase	5,679,215 A	10/1997	Barnes et al.
5,443,686 A	8/1995	Jones et al.	5,681,779 A	10/1997	Pasch et al.
5,444,217 A	8/1995	Moore	D386,076 S	11/1997	Moore
5,447,294 A	9/1995	Sakata et al.	5,683,517 A	11/1997	Shan
5,453,124 A	9/1995	Moslehi et al.	5,685,912 A	11/1997	Nishizaka
D363,464 S	10/1995	Fukasawa	5,685,914 A	11/1997	Hills et al.
5,456,207 A	10/1995	Gedridge et al.	5,690,742 A	11/1997	Ogata et al.
5,456,757 A	10/1995	Aruga et al.	5,695,567 A	12/1997	Kordina
5,461,214 A	10/1995	Peck et al.	5,697,706 A	12/1997	Ciaravino et al.
5,462,899 A	10/1995	Ikeda	5,698,036 A	12/1997	Ishii et al.
5,463,176 A	10/1995	Eckert	5,700,729 A	12/1997	Lee et al.
5,464,313 A	11/1995	Ohsawa	5,708,825 A	1/1998	Sotomayor
5,474,410 A	12/1995	Ozawa et al.	5,709,745 A	1/1998	Larkin et al.
5,474,612 A	12/1995	Sato et al.	5,711,811 A	1/1998	Suntola et al.
5,480,488 A	1/1996	Bittner et al.	5,716,133 A	2/1998	Hosokawa et al.
5,480,818 A	1/1996	Matsumoto et al.	5,718,574 A	2/1998	Shimazu
5,482,559 A	1/1996	Imai et al.	5,720,927 A	2/1998	Cripe et al.
5,484,484 A	1/1996	Yamaga et al.	D392,855 S	3/1998	Pillow
5,494,439 A	2/1996	Goldstein et al.	5,724,748 A	3/1998	Brooks
5,494,494 A	2/1996	Mizuno et al.	5,728,223 A	3/1998	Murakarni et al.
5,496,408 A	3/1996	Motoda et al.	5,728,425 A	3/1998	Ebe et al.
5,501,740 A	3/1996	Besen et al.	5,730,801 A	3/1998	Tepman et al.
5,503,875 A	4/1996	Imai et al.	5,730,802 A	3/1998	Ishizumi et al.
5,504,042 A	4/1996	Cho et al.	5,732,597 A	3/1998	Devenyi
5,510,277 A	4/1996	Cunningham et al.	5,732,744 A	3/1998	Barr et al.
5,512,102 A	4/1996	Yamazaki	5,736,314 A	4/1998	Hayes et al.
5,514,439 A	5/1996	Sibley	5,753,835 A	5/1998	Gustin
5,518,549 A	5/1996	Hellwig	5,754,390 A	5/1998	Sandhu et al.
5,519,234 A	5/1996	Paz de Araujo	5,759,281 A	6/1998	Gurary et al.
5,520,743 A	5/1996	Takahashi et al.	5,761,328 A	6/1998	Solberg et al.
5,523,616 A	6/1996	Yasuhide	5,766,365 A	6/1998	Umutoy et al.
5,527,111 A	6/1996	Lysen et al.	5,768,125 A	6/1998	Zinger et al.
5,527,417 A	6/1996	Iida et al.	5,769,952 A	6/1998	Komino
5,531,218 A	7/1996	Krebs	5,775,889 A	7/1998	Kobayashi et al.
5,531,835 A	7/1996	Fodor et al.	5,777,838 A	7/1998	Tamagawa et al.
5,537,311 A	7/1996	Stevens	5,779,203 A	7/1998	Edlinger
5,540,059 A	7/1996	Yokokawa	5,781,693 A	7/1998	Ballance et al.
5,540,898 A	7/1996	Davidson	5,782,979 A	7/1998	Kaneno
5,554,557 A	9/1996	Koh	5,790,750 A	8/1998	Anderson
5,556,275 A	9/1996	Sakata et al.	5,791,782 A	8/1998	Wooten et al.
5,558,717 A	9/1996	Zhao et al.	5,792,272 A	8/1998	Van Os et al.
5,559,046 A	9/1996	Oishi et al.	5,796,074 A	8/1998	Edelstein et al.
5,562,383 A	10/1996	Iwai et al.	5,801,104 A	9/1998	Schuegraf et al.
5,562,947 A	10/1996	White et al.	5,801,945 A	9/1998	Commer
5,562,952 A	10/1996	Nakahigashi et al.	5,806,980 A	9/1998	Berrian
5,569,402 A	10/1996	Meisser et al.	5,813,851 A	9/1998	Nakao
5,574,247 A	11/1996	Nishitani et al.	5,818,716 A	10/1998	Chin et al.
5,576,629 A	11/1996	Turner	5,819,092 A	10/1998	Ferguson et al.
5,577,331 A	11/1996	Suzuki	5,819,434 A	10/1998	Herchen et al.
			5,820,366 A	10/1998	Lee
			5,820,685 A	10/1998	Kurihira et al.
			5,820,686 A	10/1998	Moore
			5,826,129 A	10/1998	Hasebe et al.

(56)

References Cited

U.S. PATENT DOCUMENTS

5,827,420 A	10/1998	Shirazi et al.	6,001,267 A	12/1999	Van Os et al.
5,827,435 A	10/1998	Samukawa	6,004,204 A	12/1999	Luxton et al.
5,827,757 A	10/1998	Robinson, Jr. et al.	D419,652 S	1/2000	Hall et al.
5,836,483 A	11/1998	Disel	6,013,553 A	1/2000	Wallace
5,837,058 A	11/1998	Chen et al.	6,013,920 A	1/2000	Gordon et al.
5,837,320 A	11/1998	Hampden-Smith et al.	6,014,677 A	1/2000	Hayashi et al.
5,844,683 A	12/1998	Pavloski et al.	6,015,459 A	1/2000	Jamison et al.
5,846,332 A	12/1998	Zhao et al.	6,015,465 A	1/2000	Kholodenko et al.
5,851,294 A	12/1998	Young et al.	6,017,779 A	1/2000	Miyasaka
5,851,299 A	12/1998	Cheng et al.	6,017,818 A	1/2000	Lu
5,852,445 A	12/1998	Yoshikawa et al.	6,022,180 A	2/2000	Motoyama et al.
5,852,879 A	12/1998	Schumaier	6,022,802 A	2/2000	Jang
5,853,484 A	12/1998	Jeong	6,024,799 A	2/2000	Chen
D403,949 S	1/1999	Nakamura	6,025,117 A	2/2000	Nakano et al.
D404,370 S	1/1999	Kimura	6,027,163 A	2/2000	Longenecker et al.
D404,372 S	1/1999	Ishii	6,029,602 A	2/2000	Bhatnagar
5,855,680 A	1/1999	Soininen et al.	6,030,900 A	2/2000	Grassl et al.
5,855,681 A	1/1999	Maydan et al.	6,033,215 A	3/2000	Ohsawa
5,855,687 A	1/1999	DuBois et al.	6,035,101 A	3/2000	Sajoto et al.
5,855,726 A	1/1999	Soraoka et al.	6,035,804 A	3/2000	Arami et al.
5,857,777 A	1/1999	Schuh	6,039,809 A	3/2000	Toyama et al.
5,861,233 A	1/1999	Sekine et al.	6,042,652 A	3/2000	Hyun
5,862,302 A	1/1999	Okase	6,044,860 A	4/2000	Neu
5,863,123 A	1/1999	Lee et al.	6,045,260 A	4/2000	Schwartz et al.
5,865,205 A	2/1999	Wilmer	6,048,154 A	4/2000	Wytman
5,866,795 A	2/1999	Wang et al.	6,050,506 A	4/2000	Guo et al.
5,871,586 A	2/1999	Crawley et al.	6,053,982 A	4/2000	Halpin et al.
5,872,065 A	2/1999	Sivaramakrishnan	6,053,983 A	4/2000	Saeki et al.
5,873,942 A	2/1999	Park	6,054,013 A	4/2000	Collins et al.
5,877,095 A	3/1999	Tamura et al.	6,054,678 A	4/2000	Miyazaki
5,879,128 A	3/1999	Tietz et al.	6,060,691 A	5/2000	Minami et al.
5,879,459 A	3/1999	Gadgil et al.	6,060,721 A	5/2000	Huang
5,880,980 A	3/1999	Rothacher et al.	6,063,196 A	5/2000	Li et al.
5,882,165 A	3/1999	Maydan et al.	6,066,204 A	5/2000	Haven
5,884,640 A	3/1999	Fishkin et al.	6,068,441 A	5/2000	Raaijmakers et al.
5,888,304 A	3/1999	Umotoy et al.	6,071,572 A	6/2000	Mosely et al.
5,891,251 A	4/1999	MacLeish et al.	6,072,163 A	6/2000	Armstrong et al.
5,893,741 A	4/1999	Huang	6,073,973 A	6/2000	Boscaljon et al.
5,897,348 A	4/1999	Wu	6,074,154 A	6/2000	Ueda et al.
5,897,378 A	4/1999	Eriguchi	6,074,443 A	6/2000	Venkatesh
5,897,379 A	4/1999	Ulrich et al.	6,074,514 A	6/2000	Bjorkman et al.
D409,894 S	5/1999	McClurg	6,077,027 A	6/2000	Kawamura et al.
5,904,170 A	5/1999	Harvey et al.	6,079,356 A	6/2000	Umotoy et al.
D411,516 S	6/1999	Imafuku et al.	6,079,927 A	6/2000	Muka
5,908,672 A	6/1999	Ryu	6,083,321 A	7/2000	Lei et al.
5,915,200 A	6/1999	Tokumasu et al.	6,086,677 A	7/2000	Umotoy et al.
5,915,562 A	6/1999	Nyseth et al.	6,090,212 A	7/2000	Mahawili
5,916,365 A	6/1999	Sherman	6,090,659 A	7/2000	Laibowitz et al.
D412,270 S	7/1999	Fredrickson	6,091,062 A	7/2000	Pfahnl et al.
5,920,798 A	7/1999	Higuchi et al.	6,093,252 A	7/2000	Wengert et al.
5,928,426 A	7/1999	Aitchison	6,093,253 A	7/2000	Lofgren
D412,512 S	8/1999	Boisvert	6,095,083 A	8/2000	Rice et al.
5,937,142 A	8/1999	Moslehi et al.	6,096,133 A	8/2000	Yuuki et al.
5,937,323 A	8/1999	Orczyk et al.	6,096,267 A	8/2000	Kishkovich
5,939,886 A	8/1999	Turner et al.	6,099,302 A	8/2000	Hong et al.
5,947,718 A	9/1999	Weaver	6,099,649 A	8/2000	Schmitt et al.
5,950,327 A	9/1999	Peterson et al.	6,099,651 A	8/2000	Sajoto et al.
5,950,925 A	9/1999	Fukunaga et al.	6,102,565 A	8/2000	Kita et al.
5,954,375 A	9/1999	Trickle et al.	6,104,002 A	8/2000	Hirose et al.
5,961,775 A	10/1999	Fujimura	6,104,011 A	8/2000	Juliano
5,968,275 A	10/1999	Lee et al.	6,104,401 A	8/2000	Parsons
5,970,621 A	10/1999	Bazydola	6,106,625 A	8/2000	Koai et al.
5,972,196 A	10/1999	Murphy et al.	6,106,678 A	8/2000	Shufflebotham
5,975,492 A	11/1999	Brenes	6,110,531 A	8/2000	Paz de Araujo et al.
5,979,506 A	11/1999	Aarseth	6,113,703 A	9/2000	Anderson et al.
5,982,931 A	11/1999	Ishimaru	6,119,710 A	9/2000	Brown
5,984,391 A	11/1999	Vanderpot et al.	6,121,061 A	9/2000	Van Bilsen et al.
5,987,480 A	11/1999	Donohue et al.	6,121,158 A	9/2000	Benchikha et al.
5,989,342 A	11/1999	Ikeda et al.	6,122,036 A	9/2000	Yamasaki et al.
5,992,453 A	11/1999	Zimmer	6,124,600 A	9/2000	Moroishi et al.
5,997,588 A	12/1999	Goodwin	6,125,789 A	10/2000	Gupta et al.
5,997,768 A	12/1999	Scully	6,126,744 A	10/2000	Hawkins et al.
5,998,870 A	12/1999	Lee et al.	6,126,848 A	10/2000	Li et al.
6,000,732 A	12/1999	Scheler et al.	6,127,249 A	10/2000	Hu
6,001,183 A	12/1999	Gurary et al.	6,129,044 A	10/2000	Zhao et al.
			6,129,546 A	10/2000	Sada
			6,132,207 A	10/2000	Stoutjesdijk
			6,134,807 A	10/2000	Komino
			6,135,460 A	10/2000	Wise et al.

(56)

References Cited

U.S. PATENT DOCUMENTS

6,137,240	A	10/2000	Bogdan	6,284,149	B1	9/2001	Li et al.
6,139,239	A	10/2000	Snijders	6,287,965	B1	9/2001	Kang et al.
6,140,252	A	10/2000	Cho et al.	6,287,988	B1	9/2001	Nagamine et al.
6,143,079	A	11/2000	Halpin	6,293,700	B1	9/2001	Lund et al.
6,143,082	A	11/2000	McInerney et al.	D449,873	S	10/2001	Bronson
6,146,463	A	11/2000	Yudovsky et al.	6,296,710	B1	10/2001	Allen et al.
6,148,761	A	11/2000	Majewski et al.	6,296,711	B1	10/2001	Loan et al.
6,151,446	A	11/2000	Hunter et al.	6,296,909	B1	10/2001	Spitsberg
6,152,070	A	11/2000	Fairbairn et al.	6,297,539	B1	10/2001	Ma et al.
6,156,151	A	12/2000	Komino et al.	6,299,133	B2	10/2001	Waragai et al.
6,158,941	A	12/2000	Muka et al.	6,302,964	B1	10/2001	Umotoy et al.
6,160,244	A	12/2000	Ohashi	6,303,523	B2	10/2001	Cheung
6,161,500	A	12/2000	Kopacz et al.	6,305,898	B1	10/2001	Yamagishi et al.
6,162,323	A	12/2000	Koshimizu	6,311,016	B1	10/2001	Yanagawa et al.
6,164,894	A	12/2000	Cheng	6,312,525	B1	11/2001	Bright et al.
6,174,809	B1	1/2001	Kang et al.	6,315,512	B1	11/2001	Tabrizi et al.
6,176,929	B1	1/2001	Fukunaga et al.	6,316,162	B1	11/2001	Jung et al.
6,178,918	B1	1/2001	Van Os et al.	6,316,371	B1	11/2001	Oosterlaken et al.
6,179,955	B1	1/2001	Shin et al.	6,320,320	B1	11/2001	Bailey et al.
6,180,979	B1	1/2001	Hofman et al.	6,321,680	B2	11/2001	Cook et al.
6,182,603	B1	2/2001	Shang et al.	6,321,780	B1	11/2001	Iwabuchi
6,183,564	B1	2/2001	Reynolds et al.	D451,893	S	12/2001	Robson
6,183,565	B1	2/2001	Granneman et al.	D452,220	S	12/2001	Robson
6,187,672	B1	2/2001	Zhao et al.	6,325,858	B1	12/2001	Wengert
6,187,691	B1	2/2001	Fukuda	6,326,322	B1	12/2001	Kim et al.
6,190,037	B1	2/2001	Das et al.	6,326,597	B1	12/2001	Lubomirsky et al.
6,190,113	B1	2/2001	Bui et al.	6,328,561	B1	12/2001	Hasper et al.
6,190,634	B1	2/2001	Lieber et al.	6,329,297	B1	12/2001	Balish
6,191,399	B1	2/2001	Van Bilsen	6,333,275	B1	12/2001	Mayer et al.
6,194,037	B1	2/2001	Terasaki et al.	6,335,049	B1	1/2002	Basceri
6,200,897	B1	3/2001	Wang et al.	6,335,240	B1	1/2002	Kim et al.
6,201,999	B1	3/2001	Jevtic	6,342,427	B1	1/2002	Choi et al.
6,203,613	B1	3/2001	Gates et al.	6,343,239	B1	1/2002	Toda et al.
6,203,618	B1	3/2001	Hashizume et al.	6,344,084	B1	2/2002	Koinuma et al.
6,207,932	B1	3/2001	Yoo	6,344,232	B1	2/2002	Jones et al.
6,207,936	B1	3/2001	de Waard	6,346,419	B1	2/2002	Ryerson et al.
6,209,221	B1	4/2001	Beulens	6,347,636	B1	2/2002	Xia
6,210,485	B1	4/2001	Zhao et al.	6,350,391	B1	2/2002	Livshits et al.
6,212,789	B1	4/2001	Kato	6,352,049	B1	3/2002	Yin et al.
6,213,708	B1	4/2001	Allen	6,352,945	B1	3/2002	Matsuki
6,214,122	B1	4/2001	Thompson	6,357,984	B1	3/2002	Zinger et al.
6,214,717	B1	4/2001	Yan et al.	6,363,294	B1	3/2002	Coronel et al.
6,217,658	B1	4/2001	Orczyk et al.	D455,024	S	4/2002	Mimick et al.
6,217,662	B1	4/2001	Kong et al.	6,367,410	B1	4/2002	Leahey et al.
6,218,288	B1	4/2001	Li et al.	6,368,773	B1	4/2002	Jung et al.
6,225,020	B1	5/2001	Jung et al.	6,368,987	B1	4/2002	Kopacz et al.
6,225,602	B1	5/2001	Buijze et al.	6,370,796	B1	4/2002	Zucker
6,225,745	B1	5/2001	Srivastava	6,372,583	B1	4/2002	Tyagi
6,230,650	B1	5/2001	Yamazaki	6,374,831	B1	4/2002	Chandran
6,231,290	B1	5/2001	Kikuchi et al.	6,375,312	B1	4/2002	Ikeda et al.
6,235,858	B1	5/2001	Swarup et al.	6,375,749	B1	4/2002	Boydston et al.
6,238,734	B1	5/2001	Senzaki et al.	6,375,750	B1	4/2002	Van Os et al.
6,239,715	B1	5/2001	Belton	6,379,466	B1	4/2002	Sahin et al.
6,240,875	B1	6/2001	Wijck et al.	D457,609	S	5/2002	Piano
6,241,822	B1	6/2001	Ide	6,383,300	B1	5/2002	Saito et al.
6,242,359	B1	6/2001	Misra	6,383,566	B1	5/2002	Zagdoun
6,243,654	B1	6/2001	Johnson et al.	6,383,955	B1	5/2002	Matsuki
6,245,665	B1	6/2001	Yokoyama	6,387,207	B1	5/2002	Janakiraman
6,247,245	B1	6/2001	Ishii	6,387,827	B1	5/2002	Mertens et al.
6,250,250	B1	6/2001	Maishev et al.	6,390,753	B1	5/2002	de Ridder et al.
6,255,221	B1	7/2001	Hudson et al.	6,390,754	B2	5/2002	Yamaga et al.
6,257,758	B1	7/2001	Culbertson	6,391,803	B1	5/2002	Kim et al.
6,261,648	B1	7/2001	Akiba et al.	6,395,650	B1	5/2002	Callegari et al.
6,264,467	B1	7/2001	Lue et al.	6,398,184	B1	6/2002	Sowada et al.
6,265,113	B1	7/2001	Rosasco et al.	6,399,022	B1	6/2002	Schuler et al.
6,265,311	B1	7/2001	Hautala et al.	6,402,806	B1	6/2002	Schmitt et al.
6,270,572	B1	8/2001	Kim et al.	6,410,433	B1	6/2002	Hautala et al.
6,271,148	B1	8/2001	Kao	6,410,459	B2	6/2002	Blalock et al.
6,271,320	B1	8/2001	Keller et al.	6,410,463	B1	6/2002	Matsuki
6,274,496	B1	8/2001	Leusink et al.	6,413,321	B1	7/2002	Kim et al.
6,274,878	B1	8/2001	Li et al.	6,413,583	B1	7/2002	Moghadam et al.
6,281,098	B1	8/2001	Wang	6,420,279	B1	7/2002	Ono et al.
6,281,141	B1	8/2001	Das et al.	6,423,949	B1	7/2002	Chen et al.
6,283,692	B1	9/2001	Perlov et al.	D461,233	S	8/2002	Whalen
6,284,050	B1	9/2001	Shi et al.	D461,882	S	8/2002	Piano
				6,428,859	B1	8/2002	Chiang et al.
				6,429,465	B1	8/2002	Yagi et al.
				6,432,206	B1	8/2002	Tolt
				6,432,255	B1	8/2002	Sun et al.

(56)

References Cited

U.S. PATENT DOCUMENTS

- | | | | | | |
|--------------|---------|---------------------|--------------|---------|------------------|
| 6,432,479 B2 | 8/2002 | Chang et al. | 6,534,395 B2 | 3/2003 | Werkhoven et al. |
| 6,432,849 B1 | 8/2002 | Endo et al. | 6,536,950 B1 | 3/2003 | Green |
| 6,433,298 B1 | 8/2002 | Ishii | 6,539,891 B1 | 4/2003 | Kang et al. |
| 6,435,798 B1 | 8/2002 | Satoh | 6,540,469 B2 | 4/2003 | Matsunaga et al. |
| 6,435,865 B1 | 8/2002 | Tseng et al. | 6,540,838 B2 | 4/2003 | Sneh et al. |
| 6,436,819 B1 | 8/2002 | Zhang | 6,544,906 B2 | 4/2003 | Rotondaro et al. |
| 6,437,444 B2 | 8/2002 | Andideh | 6,552,209 B1 | 4/2003 | Lei et al. |
| 6,438,502 B1 | 8/2002 | Awtrey | 6,558,517 B2 | 5/2003 | Basceri |
| 6,439,822 B1 | 8/2002 | Kimura et al. | 6,558,755 B2 | 5/2003 | Berry et al. |
| 6,440,261 B1 | 8/2002 | Tepman et al. | 6,559,026 B1 | 5/2003 | Rossmann et al. |
| 6,441,350 B1 | 8/2002 | Stoddard et al. | 6,562,094 B2 | 5/2003 | Denker et al. |
| 6,445,574 B1 | 9/2002 | Saw et al. | 6,565,763 B1 | 5/2003 | Asakawa et al. |
| 6,446,573 B2 | 9/2002 | Hirayama et al. | 6,566,278 B1 | 5/2003 | Harvey et al. |
| 6,447,232 B1 | 9/2002 | Davis et al. | 6,569,239 B2 | 5/2003 | Arai et al. |
| 6,447,651 B1 | 9/2002 | Ishikawa et al. | 6,569,971 B2 | 5/2003 | Roh et al. |
| 6,447,937 B1 | 9/2002 | Murakawa et al. | 6,573,030 B1 | 6/2003 | Fairbairn et al. |
| 6,448,192 B1 | 9/2002 | Kaushik | 6,574,644 B2 | 6/2003 | Hsu et al. |
| 6,450,117 B1 | 9/2002 | Murugesh et al. | 6,576,062 B2 | 6/2003 | Matsuse |
| 6,450,757 B1 | 9/2002 | Saeki | 6,576,064 B2 | 6/2003 | Griffiths et al. |
| 6,451,713 B1 | 9/2002 | Tay et al. | 6,576,300 B1 | 6/2003 | Berry et al. |
| 6,454,860 B2 | 9/2002 | Metzner et al. | 6,576,564 B2 | 6/2003 | Agarwal |
| 6,454,909 B1 | 9/2002 | Matsuse et al. | 6,578,589 B1 | 6/2003 | Mayusumi |
| 6,455,098 B2 | 9/2002 | Tran et al. | 6,579,833 B1 | 6/2003 | McNallan et al. |
| 6,455,225 B1 | 9/2002 | Kong et al. | 6,580,050 B1 | 6/2003 | Miller et al. |
| 6,455,445 B2 | 9/2002 | Matsuki | 6,582,174 B1 | 6/2003 | Hayashi |
| 6,460,482 B1 | 10/2002 | Kuibira et al. | 6,583,048 B1 | 6/2003 | Vincent et al. |
| 6,461,435 B1 | 10/2002 | Littau et al. | 6,583,572 B2 | 6/2003 | Veltrop et al. |
| 6,461,436 B1 | 10/2002 | Campbell et al. | 6,587,108 B1 | 7/2003 | Guerlain et al. |
| 6,461,439 B1 | 10/2002 | Granneman et al. | 6,589,352 B1 | 7/2003 | Yudovsky et al. |
| 6,468,924 B2 | 10/2002 | Lee | 6,589,707 B2 | 7/2003 | Lee et al. |
| 6,471,779 B1 | 10/2002 | Nishio et al. | 6,589,868 B2 | 7/2003 | Rossmann |
| 6,472,266 B1 | 10/2002 | Yu et al. | 6,590,251 B2 | 7/2003 | Kang et al. |
| 6,474,987 B1 | 11/2002 | Huang et al. | 6,594,550 B1 | 7/2003 | Okrah |
| 6,475,276 B1 | 11/2002 | Elers et al. | 6,596,398 B1 | 7/2003 | Russo et al. |
| 6,475,902 B1 | 11/2002 | Hausmann et al. | 6,596,653 B2 | 7/2003 | Tan |
| 6,475,930 B1 | 11/2002 | Junker et al. | 6,598,559 B1 | 7/2003 | Vellore et al. |
| 6,478,872 B1 | 11/2002 | Chae et al. | 6,602,806 B1 | 8/2003 | Xia et al. |
| 6,481,945 B1 | 11/2002 | Hasper et al. | 6,607,602 B1 | 8/2003 | Granneman et al. |
| 6,482,331 B2 | 11/2002 | Lu et al. | 6,607,868 B2 | 8/2003 | Choi |
| 6,482,663 B1 | 11/2002 | Buckland | 6,607,948 B1 | 8/2003 | Sugiyama et al. |
| 6,483,989 B1 | 11/2002 | Okada et al. | 6,608,745 B2 | 8/2003 | Tsuruta et al. |
| 6,488,774 B1 | 12/2002 | Horie et al. | 6,610,375 B2 | 8/2003 | Akiba et al. |
| 6,490,493 B1 | 12/2002 | Dharnipragada | 6,613,685 B1 | 9/2003 | Granneman et al. |
| 6,492,625 B1 | 12/2002 | Boguslavskiy et al. | 6,616,986 B2 | 9/2003 | Sherman |
| 6,494,065 B2 | 12/2002 | Babbitt | 6,617,253 B1 | 9/2003 | Chu et al. |
| 6,494,998 B1 | 12/2002 | Brcka | 6,620,251 B2 | 9/2003 | Kitano |
| 6,496,819 B1 | 12/2002 | Bello et al. | 6,624,064 B1 | 9/2003 | Sahin |
| 6,497,734 B1 | 12/2002 | Barber et al. | 6,627,268 B1 | 9/2003 | Fair et al. |
| 6,497,767 B1 | 12/2002 | Okase et al. | 6,627,503 B2 | 9/2003 | Ma et al. |
| 6,498,091 B1 | 12/2002 | Chen et al. | 6,630,030 B1 | 10/2003 | Suntola et al. |
| 6,499,533 B2 | 12/2002 | Yamada | 6,632,478 B2 | 10/2003 | Gaillard et al. |
| 6,500,487 B1 | 12/2002 | Holst et al. | 6,633,364 B2 | 10/2003 | Hayashi |
| 6,502,530 B1 | 1/2003 | Turlot et al. | 6,635,115 B1 | 10/2003 | Fairbairn et al. |
| 6,503,079 B2 | 1/2003 | Kogano et al. | 6,635,117 B1 | 10/2003 | Kinnard et al. |
| 6,503,330 B1 | 1/2003 | Sneh et al. | 6,635,578 B1 | 10/2003 | Xu et al. |
| 6,503,365 B1 | 1/2003 | Kim et al. | 6,638,839 B2 | 10/2003 | Deng et al. |
| 6,503,562 B1 | 1/2003 | Saito et al. | 6,640,145 B2 | 10/2003 | Hoffberg et al. |
| 6,503,826 B1 | 1/2003 | Oda | 6,645,304 B2 | 11/2003 | Yamaguchi |
| 6,506,009 B1 | 1/2003 | Nulman et al. | 6,648,974 B1 | 11/2003 | Ogliari et al. |
| 6,506,253 B2 | 1/2003 | Sakuma | 6,649,921 B1 | 11/2003 | Cekic et al. |
| 6,507,410 B1 | 1/2003 | Robertson et al. | 6,652,924 B2 | 11/2003 | Sherman |
| 6,511,539 B1 | 1/2003 | Raaijmakers | 6,656,281 B1 | 12/2003 | Ueda |
| 6,514,313 B1 | 2/2003 | Spiegelman | 6,656,282 B2 | 12/2003 | Kim et al. |
| 6,514,666 B1 | 2/2003 | Choi et al. | 6,660,662 B2 | 12/2003 | Ishikawa et al. |
| 6,521,295 B1 | 2/2003 | Remington | 6,662,817 B2 | 12/2003 | Yamagishi |
| 6,521,547 B1 | 2/2003 | Chang et al. | 6,663,332 B1 | 12/2003 | Sluijk et al. |
| 6,527,884 B1 | 3/2003 | Takakuwa et al. | 6,673,196 B1 | 1/2004 | Oyabu |
| 6,528,171 B1 | 3/2003 | Endler et al. | 6,676,290 B1 | 1/2004 | Lu |
| 6,528,430 B2 | 3/2003 | Kwan | 6,676,759 B1 | 1/2004 | Takagi |
| 6,528,752 B1 | 3/2003 | Ishii et al. | 6,679,194 B2 | 1/2004 | Ham et al. |
| 6,528,767 B2 | 3/2003 | Bagley et al. | 6,682,971 B2 | 1/2004 | Tsuneda et al. |
| 6,530,994 B1 | 3/2003 | Mahawili | 6,682,973 B1 | 1/2004 | Paton et al. |
| 6,531,193 B2 | 3/2003 | Fonash et al. | 6,683,274 B1 | 1/2004 | Kwon et al. |
| 6,531,412 B2 | 3/2003 | Conti et al. | D486,891 S | 2/2004 | Cronce |
| 6,534,133 B1 | 3/2003 | Kaloyeros et al. | 6,684,659 B1 | 2/2004 | Tanaka et al. |
| | | | 6,684,719 B2 | 2/2004 | Gehner et al. |
| | | | 6,686,281 B2 | 2/2004 | Yamazaki et al. |
| | | | 6,688,784 B1 | 2/2004 | Templeton |
| | | | 6,689,220 B1 | 2/2004 | Nguyen |

(56)

References Cited

U.S. PATENT DOCUMENTS

- | | | | | | |
|---------------|---------|-----------------------------------|--------------|---------|--------------------------|
| 6,692,575 B1 | 2/2004 | Omstead et al. | 6,858,524 B2 | 2/2005 | Haukka et al. |
| 6,692,576 B2 | 2/2004 | Halpin et al. | 6,858,547 B2 | 2/2005 | Metzner |
| 6,696,367 B1 | 2/2004 | Aggarwal | 6,861,642 B2 | 3/2005 | Ichiki et al. |
| 6,699,003 B2 | 3/2004 | Saeki | 6,863,019 B2 | 3/2005 | Shamouilian |
| 6,699,399 B1 | 3/2004 | Qian et al. | 6,863,281 B2 | 3/2005 | Endou et al. |
| 6,700,089 B1 | 3/2004 | Hirooka | 6,864,041 B2 | 3/2005 | Brown |
| 6,709,989 B2 | 3/2004 | Ramdani et al. | 6,867,086 B1 | 3/2005 | Chen et al. |
| 6,710,364 B2 | 3/2004 | Guldi et al. | 6,867,859 B1 | 3/2005 | Powell |
| 6,710,857 B2 | 3/2004 | Kondo | 6,872,258 B2 | 3/2005 | Park et al. |
| 6,712,949 B2 | 3/2004 | Gopal | 6,872,259 B2 | 3/2005 | Strang |
| 6,713,824 B1 | 3/2004 | Mikata | D504,142 S | 4/2005 | Horner-Richardson et al. |
| 6,715,949 B1 | 4/2004 | Fisher et al. | 6,874,247 B1 | 4/2005 | Hsu |
| 6,716,571 B2 | 4/2004 | Gabriel | 6,874,480 B1 | 4/2005 | Ismailov |
| 6,719,499 B1 | 4/2004 | Kuznetsov et al. | 6,875,477 B2 | 4/2005 | Trickett et al. |
| 6,720,260 B1 | 4/2004 | Fair et al. | 6,875,677 B1 | 4/2005 | Conley, Jr. et al. |
| 6,720,531 B1 | 4/2004 | Jacobson et al. | 6,876,017 B2 | 4/2005 | Goodner |
| 6,722,837 B2 | 4/2004 | Inui | 6,876,191 B2 | 4/2005 | de Ridder |
| 6,723,642 B1 | 4/2004 | Lim et al. | 6,878,206 B2 | 4/2005 | Tzu et al. |
| 6,730,614 B1 | 5/2004 | Lim et al. | 6,878,402 B2 | 4/2005 | Chiang et al. |
| 6,732,006 B2 | 5/2004 | Haanstra et al. | 6,883,733 B1 | 4/2005 | Lind |
| 6,734,090 B2 | 5/2004 | Agarwala et al. | 6,884,066 B2 | 4/2005 | Nguyen et al. |
| 6,734,631 B2 | 5/2004 | Juestel et al. | 6,884,295 B2 | 4/2005 | Ishii |
| 6,737,716 B1 | 5/2004 | Matsuo et al. | 6,884,319 B2 | 4/2005 | Kim |
| 6,740,853 B1 | 5/2004 | Johnson et al. | 6,884,475 B2 | 4/2005 | Basceri |
| 6,743,475 B2 | 6/2004 | Skarp et al. | D505,590 S | 5/2005 | Greiner |
| 6,743,738 B2 | 6/2004 | Todd et al. | 6,889,211 B1 | 5/2005 | Yoshiura et al. |
| 6,745,095 B1 | 6/2004 | Ben-Dov | 6,889,864 B2 | 5/2005 | Lindfors et al. |
| 6,746,240 B2 | 6/2004 | de Ridder et al. | 6,890,596 B2 | 5/2005 | Sarigiannis et al. |
| 6,746,308 B1 | 6/2004 | Bode et al. | 6,895,158 B2 | 5/2005 | Alyward et al. |
| 6,749,671 B2 | 6/2004 | Holst et al. | 6,899,507 B2 | 5/2005 | Yamagishi et al. |
| 6,753,507 B2 | 6/2004 | Fure et al. | 6,902,395 B2 | 6/2005 | Oosterlaken et al. |
| 6,755,221 B2 | 6/2004 | Jeong et al. | 6,909,839 B2 | 6/2005 | Wang et al. |
| 6,756,085 B2 | 6/2004 | Waldfried | 6,911,092 B2 | 6/2005 | Sneh |
| 6,756,293 B2 | 6/2004 | Li et al. | 6,913,152 B2 | 7/2005 | Zuk |
| 6,756,318 B2 | 6/2004 | Nguyen et al. | 6,913,796 B2 | 7/2005 | Albano et al. |
| 6,759,098 B2 | 7/2004 | Han | 6,916,398 B2 | 7/2005 | Chen et al. |
| 6,760,981 B2 | 7/2004 | Leap | 6,916,559 B2 | 7/2005 | Murakawa et al. |
| 6,766,545 B2* | 7/2004 | Hodges E03C 1/20
210/164 | 6,917,755 B2 | 7/2005 | Nguyen et al. |
| 6,767,447 B2 | 7/2004 | Uno et al. | 6,924,078 B2 | 8/2005 | Lee et al. |
| D494,552 S | 8/2004 | Tezuka et al. | 6,928,890 B2 | 8/2005 | Gehner et al. |
| 6,776,849 B2 | 8/2004 | Aggarwal et al. | 6,929,699 B2 | 8/2005 | Whitesell |
| 6,780,704 B1 | 8/2004 | Raaijmakers et al. | 6,929,700 B2 | 8/2005 | Tan et al. |
| 6,783,875 B2 | 8/2004 | Yamada et al. | 6,930,041 B2 | 8/2005 | Agarwal |
| 6,784,033 B1 | 8/2004 | Yamazaki | 6,930,059 B2 | 8/2005 | Conley, Jr. et al. |
| 6,784,108 B1 | 8/2004 | Donohoe et al. | 6,935,269 B2 | 8/2005 | Lee et al. |
| D496,008 S | 9/2004 | Takahashi et al. | 6,939,579 B2 | 9/2005 | Bondestam et al. |
| 6,786,997 B1 | 9/2004 | Yamazaki | 6,939,817 B2 | 9/2005 | Sandhu et al. |
| D497,536 S | 10/2004 | Fujiwara | 6,942,753 B2 | 9/2005 | Choi et al. |
| D497,977 S | 11/2004 | Engelbrektsson | 6,949,204 B1 | 9/2005 | Lenz et al. |
| 6,811,960 B2 | 11/2004 | Lee et al. | 6,951,587 B1 | 10/2005 | Narushima |
| 6,812,157 B1 | 11/2004 | Gadgil | 6,952,656 B1 | 10/2005 | Cordova et al. |
| 6,815,350 B2 | 11/2004 | Kim et al. | 6,953,609 B2 | 10/2005 | Carollo |
| 6,815,352 B1 | 11/2004 | Tamura et al. | 6,955,741 B2 | 10/2005 | Yamagishi |
| 6,818,864 B2 | 11/2004 | Ptak | 6,955,836 B2 | 10/2005 | Kumagai et al. |
| 6,820,570 B2 | 11/2004 | Kilpela et al. | 6,955,928 B1 | 10/2005 | Brennan |
| 6,821,910 B2 | 11/2004 | Adomaitis et al. | 6,963,052 B2 | 11/2005 | Kuibira et al. |
| 6,824,665 B2 | 11/2004 | Shelnut et al. | 6,972,055 B2 | 12/2005 | Sferlazzo |
| 6,825,134 B2 | 11/2004 | Law et al. | 6,972,478 B1 | 12/2005 | Waite et al. |
| D499,620 S | 12/2004 | Horner-Richardson et al. | 6,974,781 B2 | 12/2005 | Timmermans et al. |
| 6,827,789 B2 | 12/2004 | Lee et al. | 6,975,921 B2 | 12/2005 | Verhaar |
| 6,828,235 B2 | 12/2004 | Takano | 6,976,822 B2 | 12/2005 | Woodruff |
| 6,831,004 B2 | 12/2004 | Byun | RE38,937 E | 1/2006 | Nakamura |
| 6,833,024 B2 | 12/2004 | Holst et al. | 6,981,832 B2 | 1/2006 | Zinger et al. |
| 6,835,039 B2 | 12/2004 | Van Den Berg | 6,982,046 B2 | 1/2006 | Srivastava et al. |
| 6,838,122 B2 | 1/2005 | Basceri et al. | 6,982,103 B2 | 1/2006 | Basceri et al. |
| 6,841,201 B2 | 1/2005 | Shanov et al. | 6,984,591 B1 | 1/2006 | Buchanan et al. |
| 6,843,202 B2 | 1/2005 | Kusuda | 6,984,595 B1 | 1/2006 | Yamazaki |
| 6,846,146 B2 | 1/2005 | Inui | 6,985,788 B2 | 1/2006 | Haanstra et al. |
| 6,846,515 B2 | 1/2005 | Vrtis | 6,986,914 B2 | 1/2006 | Elers et al. |
| 6,846,742 B2 | 1/2005 | Rossmann | 6,987,155 B2 | 1/2006 | Roh et al. |
| 6,847,014 B1 | 1/2005 | Benjamin et al. | 6,990,430 B2 | 1/2006 | Hosek |
| 6,849,241 B2 | 2/2005 | Dauelsberg et al. | 7,005,227 B2 | 2/2006 | Yueh et al. |
| 6,849,857 B2 | 2/2005 | Ichiki et al. | 7,005,391 B2 | 2/2006 | Min |
| 6,854,580 B2 | 2/2005 | Braford | 7,008,879 B2 | 3/2006 | Lee et al. |
| | | | 7,010,580 B1 | 3/2006 | Fu et al. |
| | | | 7,017,514 B1 | 3/2006 | Shepherd et al. |
| | | | 7,018,941 B2 | 3/2006 | Cui et al. |
| | | | 7,021,330 B2 | 4/2006 | Maula et al. |
| | | | 7,021,881 B2 | 4/2006 | Yamagishi |

(56)

References Cited

U.S. PATENT DOCUMENTS

7,036,453 B2	5/2006	Ishikawa et al.	7,211,524 B2	5/2007	Ryu et al.
7,041,609 B2	5/2006	Vaartstra	7,211,525 B1	5/2007	Shanker
7,045,430 B2	5/2006	Ahn et al.	7,214,630 B1	5/2007	Varadarajan et al.
7,049,226 B2	5/2006	Chung et al.	7,217,617 B2	5/2007	Basceri
7,049,247 B2	5/2006	Gates et al.	7,223,014 B2	5/2007	Lojen
7,052,584 B2	5/2006	Basceri	7,208,413 B2	6/2007	Byun et al.
7,053,009 B2	5/2006	Conley, Jr. et al.	7,234,476 B2	6/2007	Arai
7,055,263 B2	6/2006	Wu et al.	7,235,137 B2	6/2007	Kitayama et al.
7,055,875 B2	6/2006	Bonora	7,235,482 B2	6/2007	Wu
7,062,161 B2	6/2006	Kusuda et al.	7,235,501 B2	6/2007	Ahn et al.
D524,600 S	7/2006	Austin et al.	7,238,596 B2	7/2007	Kouvetakis et al.
D525,127 S	7/2006	Cogley et al.	7,238,616 B2	7/2007	Agarwal
7,070,178 B2	7/2006	Van Der Toorn et al.	7,238,653 B2	7/2007	Lee et al.
7,071,051 B1	7/2006	Jeon et al.	D549,815 S	8/2007	Murphy
7,073,834 B2	7/2006	Matsumoto et al.	7,256,375 B2	8/2007	Oosterlaken
7,074,690 B1	7/2006	Gauri et al.	7,265,061 B1	9/2007	Cho et al.
7,077,614 B1	7/2006	Hasper et al.	7,274,867 B2	9/2007	Peukert
7,080,545 B2	7/2006	Dimeo et al.	D553,104 S	10/2007	Oohashi et al.
7,084,060 B1	8/2006	Furukawa	7,279,256 B2	10/2007	Son
7,084,079 B2	8/2006	Conti et al.	7,290,813 B2	11/2007	Bonora
7,085,623 B2	8/2006	Siegers	7,294,581 B2	11/2007	Haverkort et al.
7,086,347 B2	8/2006	Howald et al.	7,296,460 B2	11/2007	Dimeo et al.
7,088,003 B2	8/2006	Gates et al.	7,297,641 B2	11/2007	Todd et al.
7,090,394 B2	8/2006	Hashikura et al.	7,298,009 B2	11/2007	Yan et al.
7,092,287 B2	8/2006	Beulens et al.	7,301,623 B1	11/2007	Madsen et al.
7,098,149 B2	8/2006	Lukas	D556,704 S	12/2007	Nakamura et al.
7,098,150 B2	8/2006	Misra et al.	D557,226 S	12/2007	Uchino et al.
7,100,459 B2	9/2006	Gehner et al.	D558,021 S	12/2007	Lawrence
7,101,763 B1	9/2006	Anderson et al.	7,307,028 B2	12/2007	Goto et al.
7,108,753 B2	9/2006	Wood	7,307,178 B2	12/2007	Kiyomori et al.
7,109,098 B1	9/2006	Ramaswamy et al.	7,312,148 B2	12/2007	Ramaswamy et al.
7,109,114 B2	9/2006	Chen et al.	7,312,162 B2	12/2007	Ramaswamy et al.
7,111,232 B1	9/2006	Bascom	7,312,494 B2	12/2007	Ahn et al.
7,115,305 B2	10/2006	Bronikowski et al.	D559,993 S	1/2008	Nagakubo et al.
7,115,838 B2	10/2006	Kurara et al.	D559,994 S	1/2008	Nagakubo et al.
7,122,085 B2	10/2006	Shero et al.	7,320,544 B2	1/2008	Hsieh
7,122,222 B2	10/2006	Xiao et al.	7,323,401 B2	1/2008	Ramaswamy et al.
7,122,844 B2	10/2006	Nakamura et al.	D562,357 S	2/2008	Hardy
7,129,165 B2	10/2006	Basol et al.	7,326,656 B2	2/2008	Brask et al.
7,132,360 B2	11/2006	Schaeffer et al.	7,326,657 B2	2/2008	Xia et al.
7,135,421 B2	11/2006	Ahn et al.	7,327,948 B1	2/2008	Shrinivasan
7,140,558 B2	11/2006	McCracken et al.	7,329,947 B2	2/2008	Adachi et al.
7,141,499 B2	11/2006	Raaijmakers	7,335,611 B2	2/2008	Ramaswamy et al.
7,143,897 B1	12/2006	Guzman et al.	7,351,057 B2	4/2008	Berenbak et al.
7,144,809 B2	12/2006	Elers et al.	7,354,482 B2	4/2008	Konishi et al.
7,147,766 B2	12/2006	Uzoh et al.	7,354,847 B2	4/2008	Chan et al.
7,153,542 B2	12/2006	Nguyen et al.	7,354,873 B2	4/2008	Fukazawa et al.
D535,673 S	1/2007	Conway et al.	7,356,762 B2	4/2008	van Driel
7,156,380 B2	1/2007	Soininen	7,357,138 B2	4/2008	Ji et al.
7,163,393 B2	1/2007	Adachi et al.	7,361,447 B2	4/2008	Jung
7,163,721 B2	1/2007	Zhang et al.	7,375,035 B2	5/2008	Heden et al.
7,163,900 B2	1/2007	Weber	7,376,520 B2	5/2008	Wong
7,168,852 B2	1/2007	Linnarsson	7,378,618 B1	5/2008	Sorabji et al.
7,172,497 B2	2/2007	Basol et al.	7,379,785 B2	5/2008	Higashi et al.
7,173,216 B2	2/2007	Ptak	D571,383 S	6/2008	Ota et al.
7,183,229 B2	2/2007	Yamanaka	D571,831 S	6/2008	Ota et al.
7,186,648 B1	3/2007	Rozbicki	7,381,644 B1	6/2008	Soubramonium et al.
7,192,824 B2	3/2007	Ahn et al.	7,387,685 B2	6/2008	Choi et al.
7,192,892 B2	3/2007	Ahn et al.	7,393,207 B2	7/2008	Imai
7,195,479 B2	3/2007	Beatty et al.	7,393,418 B2	7/2008	Yokogawa
7,195,693 B2	3/2007	Cowans	7,393,736 B2	7/2008	Ahn et al.
D541,125 S	4/2007	Gaudron	7,393,765 B2	7/2008	Hanawa et al.
7,198,447 B2	4/2007	Morimitsu et al.	7,396,491 B2	7/2008	Marking et al.
7,199,513 B2	4/2007	Huber et al.	7,399,388 B2	7/2008	Moghadam et al.
7,201,943 B2	4/2007	Park et al.	7,399,570 B2	7/2008	Lee et al.
7,202,148 B2	4/2007	Chen et al.	7,402,534 B2	7/2008	Mahajani
7,202,512 B2	4/2007	Chen et al.	7,405,166 B2	7/2008	Liang et al.
7,204,886 B2	4/2007	Chen et al.	7,405,454 B2	7/2008	Ahn et al.
7,204,887 B2	4/2007	Kawamura et al.	D575,713 S	8/2008	Ratcliffe
7,205,246 B2	4/2007	MacNeil et al.	7,408,225 B2	8/2008	Shinriki et al.
7,205,247 B2	4/2007	Lee et al.	7,410,290 B2	8/2008	Tanaka
7,207,763 B2	4/2007	Lee	7,410,666 B2	8/2008	Elers
7,208,198 B2	4/2007	Basceri et al.	7,411,352 B2	8/2008	Madocks
7,208,389 B1	4/2007	Tipton et al.	7,414,281 B1	8/2008	Fastow
7,210,925 B2	5/2007	Adachi	D576,001 S	9/2008	Brunderman
			7,422,635 B2	9/2008	Zheng et al.
			7,422,636 B2	9/2008	Ishizaka
			7,422,653 B2	9/2008	Blahnik et al.
			7,422,775 B2	9/2008	Ramaswamy et al.

(56)

References Cited

U.S. PATENT DOCUMENTS

7,425,224 B2	9/2008	Nguyen	7,651,583 B2	1/2010	Kent et al.
7,427,571 B2	9/2008	Lindeboom et al.	7,651,955 B2	1/2010	Ranish et al.
7,429,532 B2	9/2008	Ramaswamy et al.	7,651,959 B2	1/2010	Fukazawa et al.
7,431,966 B2	10/2008	Derderian et al.	7,651,961 B2	1/2010	Clark
7,432,476 B2	10/2008	Morita et al.	D609,652 S	2/2010	Nagasaka
7,437,060 B2	10/2008	Wang et al.	D609,655 S	2/2010	Sugimoto
7,442,275 B2	10/2008	Cowans	7,661,299 B2	2/2010	Kusunoki
7,456,429 B2	11/2008	Levy	7,662,689 B2	2/2010	Boyanov et al.
D583,395 S	12/2008	Ueda	7,670,432 B2	3/2010	Li
7,467,632 B2	12/2008	Lee et al.	7,674,726 B2	3/2010	Hasper et al.
7,473,655 B2	1/2009	Wang et al.	7,678,197 B2	3/2010	Maki
7,475,588 B2	1/2009	Dimeo et al.	7,678,715 B2	3/2010	Mungekar et al.
7,476,291 B2	1/2009	Wang et al.	7,682,454 B2	3/2010	Sneh
7,479,198 B2	1/2009	Guffrey	7,682,657 B2	3/2010	Sherman
7,482,247 B1	1/2009	Papasouliotis	D613,829 S	4/2010	Griffin et al.
7,482,283 B2	1/2009	Yamasaki et al.	D614,153 S	4/2010	Fondurulia et al.
D585,968 S	2/2009	Elkins et al.	D614,258 S	4/2010	Kojima
7,489,389 B2	2/2009	Shibazaki et al.	D614,267 S	4/2010	Breda
7,494,882 B2	2/2009	Vitale	D614,268 S	4/2010	Breda
7,497,614 B2	3/2009	Gaff	D614,593 S	4/2010	Lee
7,498,242 B2	3/2009	Kumar et al.	7,690,881 B2	4/2010	Yamagishi
7,501,292 B2	3/2009	Matsushita et al.	7,691,205 B2	4/2010	Ikedo
7,501,355 B2	3/2009	Bhatia et al.	7,692,171 B2	4/2010	Kaszuba et al.
7,503,980 B2	3/2009	Kida et al.	7,695,808 B2	4/2010	Tuma
7,504,344 B2	3/2009	Matsuki et al.	D616,390 S	5/2010	Sato
D590,933 S	4/2009	Vansell	D616,394 S	5/2010	Sato
7,514,058 B1	4/2009	Hitzman et al.	7,712,435 B2	5/2010	Yoshizaki et al.
7,514,375 B1	4/2009	Shanker et al.	7,713,874 B2	5/2010	Milligan
D593,585 S	6/2009	Ota et al.	7,716,993 B2	5/2010	Ozawa et al.
D593,969 S	6/2009	Li	7,718,930 B2	5/2010	Kawasaki et al.
7,541,297 B2	6/2009	Mallick et al.	7,720,560 B2	5/2010	Menser et al.
7,544,398 B1	6/2009	Chang et al.	7,723,648 B2	5/2010	Tsukamoto et al.
7,547,363 B2	6/2009	Tomiyasu et al.	7,725,012 B2	5/2010	Aggarwal et al.
7,547,633 B2	6/2009	Ranish et al.	7,727,864 B2	6/2010	Elers
7,550,396 B2	6/2009	Frohberg et al.	7,727,880 B1	6/2010	Chattopadhyay et al.
D596,476 S	7/2009	Welch	7,732,343 B2	6/2010	Niroomand et al.
7,561,982 B2	7/2009	Rund et al.	7,736,437 B2	6/2010	Cadwell et al.
7,563,715 B2	7/2009	Haukka et al.	7,736,528 B2	6/2010	Okita et al.
7,566,891 B2	7/2009	Rocha-Alvarez et al.	7,736,600 B2	6/2010	Clark et al.
7,569,193 B2	8/2009	Ferron et al.	7,737,035 B1	6/2010	Lind et al.
7,575,968 B2	8/2009	Sadaka et al.	7,740,437 B2	6/2010	de Ridder et al.
7,579,285 B2	8/2009	Zimmerman et al.	7,740,705 B2	6/2010	Li
7,579,785 B2	8/2009	Shinmen et al.	7,745,346 B2	6/2010	Hausmann et al.
D600,223 S	9/2009	Aggarwal	7,748,760 B2	7/2010	Kushida
7,582,555 B1	9/2009	Lang	7,749,563 B2	7/2010	Zheng et al.
7,582,575 B2	9/2009	Fukazawa et al.	7,753,584 B2	7/2010	Gambino et al.
7,589,003 B2	9/2009	Kouvetakis et al.	7,754,621 B2	7/2010	Putjkonen
7,589,028 B1	9/2009	Cho et al.	7,758,698 B2	7/2010	Bang et al.
7,589,029 B2	9/2009	Derderian et al.	7,763,869 B2	7/2010	Matsushita et al.
7,591,601 B2	9/2009	Matsuoka et al.	7,767,262 B2	8/2010	Clark
7,591,907 B2	9/2009	Chen et al.	7,771,796 B2	8/2010	Kohno et al.
D602,575 S	10/2009	Breda	7,780,440 B2	8/2010	Shibagaki et al.
7,598,513 B2	10/2009	Kouvetakis et al.	7,780,789 B2	8/2010	Wu et al.
7,601,223 B2	10/2009	Lindfors et al.	7,781,352 B2	8/2010	Fukazawa et al.
7,601,225 B2	10/2009	Tuominen et al.	7,789,559 B2	9/2010	Waser et al.
7,601,652 B2	10/2009	Singh et al.	7,789,965 B2	9/2010	Matsushita et al.
7,611,640 B1	11/2009	Howald et al.	7,790,633 B1	9/2010	Tarafdar et al.
7,611,751 B2	11/2009	Elers	7,794,546 B2	9/2010	Li
7,611,980 B2	11/2009	Wells et al.	7,798,096 B2	9/2010	Mahajani et al.
7,618,226 B2	11/2009	Takizawa	7,799,300 B2	9/2010	Lindfors et al.
7,621,672 B2	11/2009	Ripley	7,799,706 B2	9/2010	Yeom et al.
7,622,369 B1	11/2009	Lee et al.	7,803,722 B2	9/2010	Liang
7,622,378 B2	11/2009	Liu et al.	D625,977 S	10/2010	Watson et al.
7,623,940 B2	11/2009	Huskamp et al.	7,795,160 B2	10/2010	Wang et al.
D606,952 S	12/2009	Lee	7,806,587 B2	10/2010	Kobayashi
7,625,820 B1	12/2009	Papasouliotis	7,807,566 B2	10/2010	Tsuji et al.
7,629,277 B2	12/2009	Ghatnagar	7,807,578 B2	10/2010	Bencher et al.
7,632,549 B2	12/2009	Goundar	7,816,278 B2	10/2010	Reed et al.
7,638,951 B2	12/2009	DeVincentis et al.	7,824,492 B2	11/2010	Tois et al.
7,640,142 B2	12/2009	Tachikawa et al.	7,825,040 B1	11/2010	Fukazawa et al.
7,645,341 B2	1/2010	Kennedy et al.	7,829,460 B2	11/2010	Streck et al.
7,645,484 B2	1/2010	Ishizaka	7,833,348 B2	11/2010	Wada et al.
7,648,895 B2	1/2010	Kurokawa et al.	7,833,353 B2	11/2010	Furukawahara et al.
7,648,927 B2	1/2010	Singh et al.	7,838,084 B2	11/2010	Derderian et al.
7,651,269 B2	1/2010	Comendant	7,842,518 B2	11/2010	Miyajima
			7,842,622 B1	11/2010	Lee et al.
			D629,874 S	12/2010	Hermans
			7,850,449 B2	12/2010	Yang et al.
			7,851,019 B2	12/2010	Tuominen et al.

(56)

References Cited

U.S. PATENT DOCUMENTS

7,851,232 B2	12/2010	van Schravendijk et al.	8,076,251 B2	12/2011	Akae et al.
7,858,519 B2	12/2010	Liu et al.	8,078,310 B2	12/2011	Nishimoto et al.
7,858,533 B2	12/2010	Liu et al.	8,082,946 B2	12/2011	Laverdiere et al.
7,865,070 B2	1/2011	Nakamura	8,084,104 B2	12/2011	Shinriki et al.
7,871,198 B2	1/2011	Rempe et al.	8,084,372 B2	12/2011	You et al.
7,874,726 B2	1/2011	Jacobs et al.	D652,896 S	1/2012	Gether
7,884,918 B2	2/2011	Hattori	8,092,604 B2	1/2012	Tomiyasu et al.
7,888,233 B1	2/2011	Gauri	8,092,606 B2	1/2012	Park et al.
7,894,474 B1	2/2011	Bell	8,100,583 B2	1/2012	Aggarwal
D634,329 S	3/2011	Wastrom	D653,734 S	2/2012	Sisk
D634,719 S	3/2011	Yasuda et al.	D654,882 S	2/2012	Honma et al.
7,897,215 B1	3/2011	Fair et al.	D654,884 S	2/2012	Honma
7,897,217 B2	3/2011	Faguet	D655,055 S	2/2012	Toll
7,902,009 B2	3/2011	Simonelli et al.	8,110,099 B2	2/2012	Hersey et al.
7,902,582 B2	3/2011	Forbes et al.	8,114,734 B2	2/2012	Yang et al.
7,906,174 B1	3/2011	Wu et al.	8,119,466 B2	2/2012	Avouris
7,910,288 B2	3/2011	Abatchev et al.	8,119,527 B1	2/2012	Chadrashekar et al.
7,910,452 B2	3/2011	Roh et al.	D655,260 S	3/2012	Honma et al.
7,910,494 B2	3/2011	Dip et al.	D655,261 S	3/2012	Honma et al.
7,915,139 B1	3/2011	Lang	D655,599 S	3/2012	Durham
7,915,667 B2	3/2011	Knoefler et al.	8,129,290 B2	3/2012	Balseanu et al.
7,919,142 B2	4/2011	Yeom et al.	8,137,462 B2	3/2012	Fondurulia et al.
7,919,416 B2	4/2011	Lee et al.	8,137,465 B1	3/2012	Shrinivasan et al.
7,923,382 B2	4/2011	Huotari et al.	8,138,104 B2	3/2012	Balseanu et al.
7,925,378 B2	4/2011	Gilchrist et al.	8,138,676 B2	3/2012	Mills
7,935,940 B1	5/2011	Smargiassi	8,142,862 B2	3/2012	Lee et al.
7,939,447 B2	5/2011	Bauer et al.	8,143,174 B2	3/2012	Xia et al.
7,942,969 B2	5/2011	Riker et al.	8,147,242 B2	4/2012	Shibagaki et al.
7,946,762 B2	5/2011	Yednak	8,152,922 B2	4/2012	Schmidt et al.
7,951,262 B2	5/2011	Koshiishi et al.	8,158,512 B2	4/2012	Ji et al.
7,955,516 B2	6/2011	Chandrachood	8,172,947 B2	5/2012	Shibata et al.
7,955,646 B2	6/2011	Cruse et al.	8,173,554 B2	5/2012	Lee et al.
7,955,650 B2	6/2011	Tsuji	8,174,400 B2	5/2012	Park et al.
7,957,708 B2	6/2011	Karschnia et al.	8,178,436 B2	5/2012	King et al.
7,963,736 B2	6/2011	Takizawa et al.	8,187,679 B2	5/2012	Dickey et al.
7,967,913 B2	6/2011	Hua et al.	8,187,951 B1	5/2012	Wang
7,972,980 B2	7/2011	Lee et al.	8,192,901 B2	6/2012	Kageyama
7,977,256 B2	7/2011	Liu et al.	8,196,234 B2	6/2012	Glunk
7,981,751 B2	7/2011	Zhu et al.	8,197,915 B2	6/2012	Oka et al.
D643,055 S	8/2011	Takahashi	8,198,168 B2	6/2012	Tanioku
7,989,365 B2	8/2011	Park et al.	8,202,575 B2	6/2012	Monsma et al.
7,989,736 B2	8/2011	Park et al.	8,206,506 B2	6/2012	Kadkhodayan et al.
7,992,318 B2	8/2011	Kawaji	8,216,380 B2	7/2012	White et al.
7,993,457 B1	8/2011	Krotov et al.	8,227,032 B2	7/2012	Dussarrat et al.
7,994,070 B1	8/2011	Dip et al.	8,231,799 B2	7/2012	Bera et al.
7,994,721 B2	8/2011	Espiau et al.	D665,055 S	8/2012	Yanagisawa et al.
7,997,795 B2	8/2011	Schwagerman et al.	8,241,991 B2	8/2012	Hsieh et al.
7,998,875 B2	8/2011	DeYoung	8,241,992 B2	8/2012	Clevenger et al.
8,003,174 B2	8/2011	Fukazawa	8,242,028 B1	8/2012	van Schravendijk
8,003,919 B2	8/2011	Goto et al.	8,242,031 B2	8/2012	Mallick et al.
8,004,198 B2	8/2011	Bakre et al.	8,246,900 B2	8/2012	Kasai et al.
8,020,315 B2	9/2011	Nishimura	8,252,114 B2	8/2012	Vukovic
8,030,129 B2	10/2011	Jeong	8,252,659 B2	8/2012	Huyghabaert et al.
8,033,771 B1	10/2011	Gage et al.	8,252,691 B2	8/2012	Beynet et al.
8,038,835 B2	10/2011	Hayashi et al.	8,253,204 B2	8/2012	Lee et al.
8,041,197 B2	10/2011	Kasai et al.	8,267,633 B2	9/2012	Obikane
8,041,450 B2	10/2011	Takizawa et al.	8,272,516 B2	9/2012	Salvador
8,043,972 B1	10/2011	Liu et al.	8,278,176 B2	10/2012	Bauer et al.
8,046,193 B2	10/2011	Yetter et al.	8,282,769 B2	10/2012	Iizuka
8,047,711 B2	11/2011	Ploechinger	8,282,847 B2	10/2012	Romano
8,048,783 B2	11/2011	Chung et al.	8,282,992 B2	10/2012	Myo et al.
8,051,799 B2	11/2011	Itagaki et al.	8,287,648 B2	10/2012	Reed et al.
8,052,794 B2	11/2011	Sumakeris et al.	8,291,857 B2	10/2012	Lam et al.
8,055,378 B2	11/2011	Numakura	8,293,016 B2	10/2012	Bahng et al.
8,060,252 B2	11/2011	Gage et al.	8,293,642 B2	10/2012	Kim
8,083,853 B2	11/2011	Choi et al.	8,298,336 B2	10/2012	Wang et al.
RE43,023 E	12/2011	Nakashima et al.	8,298,951 B1	10/2012	Nakano
D649,986 S	12/2011	Fujikata et al.	8,307,472 B1	11/2012	Saxon et al.
D651,291 S	12/2011	Liebson et al.	8,309,173 B2	11/2012	Tuominen et al.
8,071,451 B2	12/2011	Berry	8,318,327 B2	11/2012	O'Donnell
8,071,452 B2	12/2011	Raisanen	8,323,413 B2	12/2012	Son
8,072,578 B2	12/2011	Yasuda et al.	8,324,699 B2	12/2012	Ichijo et al.
8,076,230 B2	12/2011	Wei	8,328,939 B2	12/2012	Choi et al.
8,076,237 B2	12/2011	Uzoh	8,329,599 B2	12/2012	Fukazawa et al.
8,076,250 B1	12/2011	Rajagopalan	8,333,839 B2	12/2012	Oh
			8,334,219 B2	12/2012	Lee et al.
			8,338,809 B2	12/2012	Yang et al.
			8,349,083 B2	1/2013	Takasuka et al.
			D676,943 S	2/2013	Kluss

(56)

References Cited

U.S. PATENT DOCUMENTS

8,367,528 B2	2/2013	Bauer et al.	8,697,198 B2	4/2014	Lee
8,372,204 B2	2/2013	Nakamura	8,703,002 B2	4/2014	Matsudo et al.
8,378,464 B2	2/2013	Kato et al.	8,709,162 B2	4/2014	Leung et al.
8,382,370 B2	2/2013	Aggarwal et al.	8,710,580 B2	4/2014	Sakuma et al.
8,382,939 B2	2/2013	Kutney et al.	8,711,338 B2	4/2014	Liu et al.
8,393,091 B2	3/2013	Kawamoto	D705,745 S	5/2014	Kurs et al.
8,394,466 B2	3/2013	Hong et al.	D705,762 S	5/2014	Yu
8,398,773 B2	3/2013	Jdira et al.	8,664,127 B2	5/2014	Bhatia et al.
8,402,918 B2	3/2013	Kadkhodayan et al.	8,720,965 B2	5/2014	Hino et al.
8,404,499 B2	3/2013	Moffatt	8,721,791 B2	5/2014	Choi et al.
8,415,258 B2	4/2013	Akae	8,722,510 B2	5/2014	Watanabe et al.
8,415,259 B2	4/2013	Lee et al.	8,722,546 B2	5/2014	Fukazawa et al.
8,415,587 B2	4/2013	Millman et al.	8,726,837 B2	5/2014	Patalay et al.
8,419,959 B2	4/2013	Bettencourt et al.	8,728,832 B2	5/2014	Raisanen et al.
8,425,682 B2	4/2013	Wang et al.	8,728,956 B2	5/2014	Lavoie et al.
8,430,620 B1	4/2013	Blank et al.	8,741,062 B2	6/2014	Lindfors et al.
8,440,259 B2	5/2013	Chiang et al.	8,741,065 B2	6/2014	Odagiri et al.
8,443,484 B2	5/2013	Ozaki et al.	8,742,668 B2	6/2014	Nakano et al.
8,444,120 B2	5/2013	Gregg et al.	8,758,512 B2	6/2014	Lee
8,445,075 B2	5/2013	Xu et al.	8,759,223 B2	6/2014	Sapre et al.
8,450,191 B2	5/2013	Wang	D709,536 S	7/2014	Yoshimura et al.
8,454,749 B2	6/2013	Li	D709,537 S	7/2014	Kuwabara et al.
8,465,811 B2	6/2013	Ueda	8,764,085 B2	7/2014	Urabe
8,465,903 B2	6/2013	Weidman et al.	8,771,791 B2	7/2014	Lee et al.
8,466,411 B2	6/2013	Arai	8,771,807 B2	7/2014	Xiao et al.
8,470,187 B2	6/2013	Ha	8,779,502 B2	7/2014	Sakuma et al.
8,470,718 B2	6/2013	Lee	8,784,950 B2	7/2014	Fukazawa et al.
8,484,846 B2	7/2013	Dhindsa	8,784,951 B2	7/2014	Fukazawa et al.
8,492,170 B2	7/2013	Xie et al.	8,785,215 B2	7/2014	Kobayashi et al.
8,496,377 B2	7/2013	Harr et al.	8,785,311 B2	7/2014	Miyoshi
8,496,756 B2	7/2013	Cruse et al.	8,790,743 B1	7/2014	Omari
8,497,213 B2	7/2013	Yasui et al.	8,790,749 B2	7/2014	Omori et al.
8,501,599 B2	8/2013	Ueno et al.	8,802,201 B2	8/2014	Raisanen et al.
8,506,162 B2	8/2013	Schick et al.	8,809,170 B2	8/2014	Bauer
8,506,713 B2	8/2013	Takagi	D712,358 S	9/2014	Allen et al.
8,507,720 B2	8/2013	Shay	D712,359 S	9/2014	Allen et al.
8,524,612 B2	9/2013	Li et al.	8,820,809 B2	9/2014	Ando et al.
8,529,701 B2	9/2013	Morita	8,821,640 B2	9/2014	Cleary et al.
8,535,767 B1	9/2013	Kimura	8,821,985 B2	9/2014	Shao et al.
8,536,068 B2	9/2013	Weidman et al.	8,823,672 B2	9/2014	Kim
D691,974 S	10/2013	Osada et al.	8,828,886 B2	9/2014	Samukawa et al.
8,551,892 B2	10/2013	Nakano	8,841,182 B1	9/2014	Chen et al.
8,557,712 B1	10/2013	Antonelli et al.	8,845,806 B2	9/2014	Aida et al.
8,562,272 B2	10/2013	Lenz	8,846,502 B2	9/2014	Haukka et al.
8,563,443 B2	10/2013	Fukazawa	D715,410 S	10/2014	Lohmann
8,569,184 B2	10/2013	Oka	8,859,368 B2	10/2014	Deniz
D693,200 S	11/2013	Saunders	8,860,955 B2	10/2014	Rodnick et al.
D693,782 S *	11/2013	Mori D13/182	8,864,202 B1	10/2014	Schrameyer
8,573,152 B2	11/2013	de la Llera et al.	8,864,375 B2	10/2014	Abe et al.
8,573,154 B2	11/2013	Yorozuya	D716,742 S	11/2014	Jang et al.
8,586,484 B2	11/2013	Matsuyama et al.	8,876,974 B2	11/2014	Wan
8,591,659 B1	11/2013	Fang et al.	8,877,300 B2	11/2014	Lee
8,592,005 B2	11/2013	Ueda	8,877,655 B2	11/2014	Shero et al.
D694,790 S	12/2013	Matsumoto et al.	8,882,923 B2	11/2014	Saido et al.
D695,240 S	12/2013	Iida et al.	8,883,270 B2	11/2014	Shero et al.
8,608,885 B2	12/2013	Goto et al.	8,895,108 B2	11/2014	Lee
8,614,047 B2	12/2013	Ayothi et al.	8,895,395 B1	11/2014	Kerber et al.
8,616,765 B2	12/2013	Darabnia et al.	8,900,935 B2	12/2014	Guo et al.
8,617,411 B2	12/2013	Singh	8,900,999 B1	12/2014	Wu et al.
D697,038 S	1/2014	Matsumoto et al.	8,901,016 B2	12/2014	Jeongseok et al.
8,623,770 B1	1/2014	Gao et al.	8,911,553 B2	12/2014	Baluja et al.
8,633,115 B2	1/2014	Chang et al.	8,911,826 B2	12/2014	Adachi et al.
D698,904 S	2/2014	Milligan et al.	8,912,101 B2	12/2014	Tsuji et al.
8,642,488 B2	2/2014	Liu et al.	D720,838 S *	1/2015	Yamagishi D23/261
8,647,439 B2	2/2014	Sanchez et al.	8,927,906 B2	1/2015	Tadokoro et al.
8,647,722 B2	2/2014	Kobayashi et al.	8,932,802 B2	1/2015	Wu et al.
8,647,993 B2	2/2014	Lavoie et al.	8,933,375 B2	1/2015	Dunn et al.
8,651,788 B1	2/2014	Budde	8,940,646 B1	1/2015	Chandrasekharan
8,664,627 B1	3/2014	Ishikawa et al.	D723,153 S	2/2015	Borkholder
8,667,654 B2	3/2014	Gros-Jean	8,945,305 B2	2/2015	Marsh
8,668,957 B2	3/2014	Dussarrat et al.	8,945,306 B2	2/2015	Tsuda
8,669,185 B2	3/2014	Onizawa	8,945,339 B2	2/2015	Kakimoto
8,679,958 B2	3/2014	Takamure et al.	8,946,830 B2	2/2015	Jung et al.
D702,188 S	4/2014	Jacobs	8,956,971 B2	2/2015	Huakka
8,683,943 B2	4/2014	Onodera et al.	8,956,983 B2	2/2015	Swaminathan
			D723,330 S	3/2015	York
			D724,553 S	3/2015	Choi
			D724,701 S	3/2015	Yamagishi et al.
			D725,168 S	3/2015	Yamagishi

(56)

References Cited

U.S. PATENT DOCUMENTS

8,967,608 B2	3/2015	Mitsumori et al.	9,202,727 B2	12/2015	Dunn et al.
8,969,934 B1	3/2015	Cheng et al.	9,214,333 B1	12/2015	Sims et al.
8,974,868 B2	3/2015	Ishikawa et al.	9,214,340 B2	12/2015	Kurita et al.
8,980,006 B2	3/2015	Huh et al.	9,219,006 B2	12/2015	Chatterjee
8,986,456 B2	3/2015	Fondurulia et al.	9,223,203 B2	12/2015	Farm et al.
8,991,214 B2	3/2015	Hoshino et al.	9,228,259 B2	1/2016	Haukka et al.
8,991,887 B2	3/2015	Shin et al.	9,240,412 B2	1/2016	Xie et al.
8,993,054 B2	3/2015	Jung et al.	9,245,742 B2	1/2016	Haukka
8,993,457 B1	3/2015	Ramkumar et al.	9,252,024 B2	2/2016	Lam et al.
D726,365 S	4/2015	Weigensberg	9,252,238 B1	2/2016	Trevino et al.
D726,884 S	4/2015	Yamagishi et al.	9,257,274 B2	2/2016	Kang et al.
8,999,102 B2	4/2015	Miyoshi et al.	9,263,298 B2	2/2016	Matsumoto et al.
9,004,744 B1	4/2015	Kemp	9,267,204 B2	2/2016	Honma
9,005,539 B2	4/2015	Halpin et al.	9,267,850 B2	2/2016	Aggarwal
9,017,481 B1	4/2015	Pettinger et al.	D751,176 S	3/2016	Schoenherr et al.
9,017,933 B2	4/2015	Liu et al.	9,275,834 B1	3/2016	Park et al.
9,018,093 B2	4/2015	Tsuji et al.	9,281,277 B2	3/2016	Baek et al.
9,018,111 B2	4/2015	Milligan et al.	9,284,642 B2	3/2016	Nakano
9,018,567 B2	4/2015	de Ridder et al.	9,287,273 B2	3/2016	Ragnarsson et al.
9,021,985 B2	5/2015	Alokozai et al.	9,297,705 B2	3/2016	Aggarwal
9,023,737 B2	5/2015	Beynet et al.	9,299,557 B2	3/2016	Tolle et al.
9,023,738 B2	5/2015	Kato et al.	9,299,595 B2	3/2016	Dunn et al.
9,029,244 B2	5/2015	Won et al.	D753,269 S	4/2016	Yamagishi et al.
9,029,253 B2	5/2015	Milligan et al.	D753,629 S	4/2016	Plattard
9,029,272 B1	5/2015	Nakano	9,305,836 B1	4/2016	Gates et al.
D732,145 S	6/2015	Yamagishi	9,309,598 B2	4/2016	Wang et al.
D732,644 S	6/2015	Yamagishi et al.	9,309,978 B2	4/2016	Hatch et al.
D733,257 S	6/2015	Schoenherr et al.	9,310,684 B2	4/2016	Meyers et al.
D733,261 S	6/2015	Yamagishi et al.	9,312,155 B2	4/2016	Mori
D733,262 S	6/2015	Kang	9,315,897 B2	4/2016	Byun
9,057,388 B2	6/2015	Comeau et al.	9,324,811 B2	4/2016	Weeks
9,064,815 B2	6/2015	Zhang et al.	9,324,846 B1	4/2016	Camillo
D733,843 S	7/2015	Yamagishi	D756,929 S	5/2016	Harck et al.
D734,377 S	7/2015	Hirakida	9,331,200 B1	5/2016	Wang et al.
9,076,635 B2	7/2015	Gross et al.	9,337,031 B2	5/2016	Kim et al.
9,076,726 B2	7/2015	Kauerauf et al.	9,337,054 B2	5/2016	Hunks et al.
D735,836 S	8/2015	Yamagishi et al.	9,337,057 B2	5/2016	Park et al.
D736,348 S	8/2015	Tan	9,341,296 B2	5/2016	Yednak
9,095,869 B2	8/2015	Kilpi et al.	9,343,297 B1	5/2016	Fukazawa et al.
9,096,931 B2	8/2015	Yednak et al.	9,343,308 B2	5/2016	Isii
9,099,423 B2	8/2015	Weeks et al.	9,343,343 B2	5/2016	Mori
9,099,505 B2	8/2015	Kusakabe et al.	9,343,350 B2	5/2016	Arai
9,111,972 B2	8/2015	Takeshita et al.	9,349,620 B2	5/2016	Kamata et al.
9,117,657 B2	8/2015	Nakano et al.	9,353,440 B2	5/2016	Ge et al.
9,117,866 B2	8/2015	Marquardt et al.	9,353,441 B2	5/2016	Chung
D739,222 S	9/2015	Chadbourne	9,355,876 B2	5/2016	Reuter et al.
9,123,510 B2	9/2015	Nakano et al.	9,355,882 B2	5/2016	Wu et al.
9,123,577 B2	9/2015	Fujimoto et al.	D759,137 S	6/2016	Hassan
9,127,358 B2	9/2015	Inoue et al.	D759,193 S	6/2016	Gutierrez et al.
9,127,362 B2	9/2015	Scheible et al.	9,362,107 B2	6/2016	Thadani et al.
9,129,897 B2	9/2015	Pore et al.	9,362,137 B2	6/2016	Kang et al.
9,136,108 B2	9/2015	Matsushita et al.	9,362,180 B2	6/2016	Lee et al.
9,136,180 B2	9/2015	Machkaoutsan	9,365,924 B2	6/2016	Nonaka
9,142,393 B2	9/2015	Okabe et al.	9,368,352 B2	6/2016	Takamure et al.
9,142,437 B2	9/2015	Fosnight et al.	9,370,863 B2	6/2016	Tsuji et al.
9,142,764 B1	9/2015	Wang	9,378,969 B2	6/2016	Hsu et al.
9,153,441 B2	10/2015	Takamure et al.	9,384,987 B2	7/2016	Jung et al.
9,163,310 B2	10/2015	Lee	9,390,909 B2	7/2016	Pasquale et al.
9,166,012 B2	10/2015	Sim et al.	9,394,608 B2	7/2016	Shero et al.
9,169,975 B2	10/2015	Sarin et al.	9,396,934 B2	7/2016	Tolle
9,171,714 B2	10/2015	Mori	9,396,956 B1	7/2016	Fukazawa
9,171,715 B2	10/2015	Matero	9,399,228 B2	7/2016	Breiling et al.
9,171,716 B2	10/2015	Fukuda	D764,196 S	8/2016	Handler et al.
D742,202 S	11/2015	Cyphers et al.	9,404,587 B2	8/2016	Shugrue
D743,357 S	11/2015	Vyne	9,412,564 B2	8/2016	Milligan
D743,513 S	11/2015	Yamagishi	9,412,581 B2	8/2016	Thadani et al.
9,174,178 B2	11/2015	Berger et al.	9,412,582 B2	8/2016	Sasaki et al.
9,175,394 B2	11/2015	Yudovsky et al.	9,418,885 B2	8/2016	Sung et al.
9,177,784 B2	11/2015	Raisanen et al.	9,425,078 B2	8/2016	Tang et al.
9,184,047 B2	11/2015	Liu et al.	9,428,833 B1	8/2016	Duvall et al.
9,184,054 B1	11/2015	Huang et al.	9,443,725 B2	9/2016	Liu et al.
9,190,263 B2	11/2015	Ishikawa et al.	9,447,498 B2	9/2016	Shiba et al.
9,190,264 B2	11/2015	Yuasa et al.	9,449,793 B2	9/2016	Shaji et al.
9,196,483 B1	11/2015	Lee et al.	9,449,795 B2	9/2016	Sabri et al.
D745,641 S	12/2015	Blum	9,449,987 B1	9/2016	Miyata et al.
			9,455,138 B1	9/2016	Fukazawa
			9,455,177 B1	9/2016	Park et al.
			9,464,352 B2	10/2016	Nakano et al.
			9,472,432 B1	10/2016	Blank

(56)

References Cited

U.S. PATENT DOCUMENTS

9,474,163 B2	10/2016	Tolle et al.	9,786,491 B2	10/2017	Suzuki et al.
9,478,414 B2	10/2016	Kobayashi et al.	9,786,570 B2	10/2017	Kang et al.
9,478,415 B2	10/2016	Kimura	9,790,595 B2	10/2017	Jung et al.
D770,993 S	11/2016	Yoshida et al.	9,793,115 B2	10/2017	Tolle
9,484,191 B2	11/2016	Winkler	9,793,135 B1	10/2017	Zaitso et al.
9,496,225 B1	11/2016	Adusumilli et al.	9,793,148 B2	10/2017	Yamagishi et al.
9,514,927 B2	12/2016	Tolle et al.	9,798,308 B2	10/2017	Mimura
9,514,932 B2	12/2016	Mallick et al.	9,799,736 B1	10/2017	Ebrish et al.
9,520,289 B2	12/2016	Park et al.	D801,942 S	11/2017	Riker et al.
9,523,148 B1	12/2016	Pore et al.	D802,546 S	11/2017	Jang et al.
D777,546 S	1/2017	Ishii et al.	D803,802 S *	11/2017	Sasaki D13/182
9,543,180 B2	1/2017	Kamiya	9,808,246 B2	11/2017	Shelton et al.
9,556,516 B2	1/2017	Takamure	9,812,319 B1	11/2017	Fukazawa et al.
9,558,931 B2	1/2017	Tang	9,812,320 B1	11/2017	Pore et al.
9,564,312 B2	2/2017	Henri et al.	9,812,372 B2	11/2017	Choi et al.
9,564,314 B2	2/2017	Takamure et al.	9,820,289 B1	11/2017	Pawar et al.
9,570,302 B1	2/2017	Chang et al.	9,824,884 B1	11/2017	Sims et al.
9,574,268 B1	2/2017	Dunn et al.	9,824,893 B1	11/2017	Smith et al.
9,576,952 B2	2/2017	Joshi et al.	9,837,355 B2	12/2017	Briggs et al.
9,583,333 B2	2/2017	Chatterjee	9,847,221 B1	12/2017	McLaughlin et al.
9,583,345 B2	2/2017	Chen et al.	9,850,573 B1	12/2017	Sun
D782,419 S	3/2017	Willette	D807,494 S	1/2018	Kim et al.
9,589,770 B2	3/2017	Winkler	D808,254 S	1/2018	Deleu
9,605,342 B2	3/2017	Alokozai et al.	9,859,151 B1	1/2018	Niskanen
9,605,343 B2	3/2017	Winkler	9,865,455 B1	1/2018	Sims et al.
9,607,837 B1	3/2017	Namba	9,865,456 B1	1/2018	Pandey et al.
D783,351 S	4/2017	Fujino et al.	9,865,815 B2	1/2018	Hausmann
D784,276 S	4/2017	Tiner et al.	9,868,131 B2	1/2018	Kilpi et al.
9,613,801 B2	4/2017	Carcasi et al.	9,870,964 B1	1/2018	Yoshino et al.
9,627,221 B1	4/2017	Zaitso et al.	9,875,891 B2	1/2018	Henri et al.
D785,766 S	5/2017	Sato	9,875,893 B2	1/2018	Takamure et al.
D787,458 S *	5/2017	Kim D13/182	9,881,788 B2	1/2018	Kim et al.
9,640,416 B2	5/2017	Arai	D810,705 S	2/2018	Krishnan et al.
9,640,448 B2	5/2017	Ikegawa et al.	9,887,082 B1	2/2018	Pore et al.
9,640,542 B2	5/2017	Lee et al.	9,890,456 B2	2/2018	Tolle et al.
9,644,266 B2	5/2017	Nasu et al.	9,891,521 B2	2/2018	Kang et al.
9,647,114 B2	5/2017	Margetis	9,892,908 B2	2/2018	Pettinger et al.
9,653,267 B2	5/2017	Carducci et al.	9,892,913 B2	2/2018	Margetis et al.
9,657,845 B2	5/2017	Shugrue	9,895,715 B2	2/2018	Haukka et al.
9,659,799 B2	5/2017	Lawson	9,899,291 B2	2/2018	Kato
9,663,857 B2	5/2017	Nakano et al.	9,899,405 B2	2/2018	Kim
9,666,528 B1	5/2017	Bergendahl et al.	9,905,420 B2	2/2018	Margetis et al.
D789,888 S *	6/2017	Jang D13/121	9,905,492 B2	2/2018	Tang et al.
D790,041 S	6/2017	Jang et al.	9,909,492 B2	2/2018	Tang
9,680,268 B1	6/2017	Finona	9,909,214 B2	3/2018	Suemori
9,684,234 B2	6/2017	Darling et al.	9,911,676 B2	3/2018	Tang
9,685,320 B2	6/2017	Kang et al.	9,916,980 B1	3/2018	Knaepen
9,691,668 B2	6/2017	Chang et al.	9,920,451 B2	3/2018	Sivaramakrishnan et al.
9,691,771 B2	6/2017	Lansalot-Matras	9,922,824 B2	3/2018	Okada
9,698,031 B2	7/2017	Kobayashi et al.	9,929,005 B1	3/2018	Shimamoto et al.
9,708,707 B2	7/2017	Ditizio et al.	9,929,011 B2	3/2018	Hawryluk et al.
9,708,708 B2	7/2017	Isobe et al.	9,929,055 B2	3/2018	Dube et al.
9,711,345 B2	7/2017	Shiba et al.	9,951,421 B2	4/2018	Lind
D793,352 S	8/2017	Hill	9,960,033 B1	5/2018	Nozawa
D793,526 S *	8/2017	Behdjat D23/213	9,960,072 B2	5/2018	Coomer
D793,572 S	8/2017	Kozuka et al.	9,966,299 B2	5/2018	Tang et al.
D793,976 S	8/2017	Fukushima et al.	9,984,869 B1	5/2018	Blanquart
D794,753 S *	8/2017	Miller D23/213	D819,580 S	6/2018	Krishnan et al.
D795,208 S	8/2017	Sasaki et al.	9,987,747 B2	6/2018	Hwang et al.
9,735,024 B2	8/2017	Zaitso	9,991,138 B2	6/2018	Lin et al.
9,741,546 B2	8/2017	Carducci et al.	9,996,004 B2	6/2018	Smith et al.
9,741,559 B2	8/2017	Shimura et al.	9,997,357 B2	6/2018	Arghavani et al.
9,745,658 B2	8/2017	Kang et al.	9,997,373 B2	6/2018	Hudson
9,748,145 B1	8/2017	Kannan et al.	10,032,628 B2	6/2018	Xie et al.
D796,458 S	9/2017	Jang et al.	10,014,212 B2	7/2018	Chen et al.
D796,670 S	9/2017	Dolk et al.	10,017,856 B1	7/2018	Arnepalli et al.
D797,067 S	9/2017	Zhang et al.	10,018,920 B2	7/2018	Chang et al.
9,754,779 B1	9/2017	Ishikawa	10,023,960 B2	7/2018	Alokozai
9,754,818 B2	9/2017	Shiu et al.	10,032,792 B2	7/2018	Kim et al.
9,759,489 B2	9/2017	Kaneko	D825,505 S *	8/2018	Hanson D13/182
9,765,432 B2	9/2017	Ge et al.	D825,614 S	8/2018	Bever et al.
9,773,818 B2	9/2017	Kimura	10,043,661 B2	8/2018	Kato et al.
D800,782 S	10/2017	Bever et al.	10,047,435 B2	8/2018	Haukka et al.
9,778,561 B2	10/2017	Marks et al.	10,053,774 B2	8/2018	Tolle et al.
9,780,225 B2	10/2017	Venkatasubramanian et al.	10,060,473 B2	8/2018	Davey et al.
			D827,592 S	9/2018	Ichino et al.
			D829,306 S *	9/2018	Ikedo D23/261
			10,083,836 B2	9/2018	Milligan
			D830,981 S	10/2018	Jeong et al.

(56)

References Cited

U.S. PATENT DOCUMENTS

10,087,522 B2	10/2018	Raisanen et al.	10,648,788 B2	5/2020	Boyd et al.
10,087,525 B2	10/2018	Schmotzer et al.	10,714,335 B2	7/2020	Kim et al.
10,090,316 B2	10/2018	Ootsuka	10,763,139 B2	9/2020	Shindo
10,103,040 B1	10/2018	Oosterlaken et al.	D900,036 S	10/2020	Wuester et al.
10,106,892 B1	10/2018	Siddiqui et al.	D903,477 S	12/2020	Goratela et al.
RE47,145 E	11/2018	Hashimoto	D913,980 S *	3/2021	Lee D13/182
D834,686 S *	11/2018	Yamada D23/261	D914,620 S	3/2021	Rokkam et al.
10,121,671 B2	11/2018	Fu et al.	11,018,003 B2	5/2021	Huang et al.
10,134,617 B2	11/2018	Gurary et al.	D922,229 S	6/2021	Jun et al.
10,134,757 B2	11/2018	Chun et al.	2001/0000141 A1	4/2001	Zhou et al.
RE47,170 E	12/2018	Beynet et al.	2001/0001953 A1	5/2001	Griffiths et al.
10,147,600 B2	12/2018	Takamure et al.	2001/0002581 A1	6/2001	Nishikawa et al.
10,167,557 B2	1/2019	Hawkins et al.	2001/0003015 A1	6/2001	Chang et al.
10,177,024 B2	1/2019	Gomm et al.	2001/0003191 A1	6/2001	Kovacs et al.
10,177,025 B2	1/2019	Pore	2001/0003271 A1	6/2001	Otsuki
10,179,947 B2	1/2019	Fukazawa	2001/0004880 A1	6/2001	Cho et al.
10,186,420 B2	1/2019	Fukazawa	2001/0006070 A1	7/2001	Shang
10,190,213 B2	1/2019	Zhu et al.	2001/0007244 A1	7/2001	Matsuse
10,190,214 B2	1/2019	Shon et al.	2001/0007246 A1	7/2001	Ueda et al.
10,190,701 B2	1/2019	Raj et al.	2001/0007645 A1	7/2001	Honma
10,192,734 B2	1/2019	Sanchez et al.	2001/0014267 A1	8/2001	Yamaga et al.
10,193,429 B2	1/2019	Smith et al.	2001/0014514 A1	8/2001	Geusic
D840,364 S	2/2019	Ichino et al.	2001/0015343 A1	8/2001	Sprey et al.
10,204,788 B1	2/2019	Ye et al.	2001/0016273 A1	8/2001	Narasimhan et al.
10,211,308 B2	2/2019	Zhu et al.	2001/0017103 A1	8/2001	Takeshita et al.
10,229,833 B2	3/2019	Raisanen et al.	2001/0018267 A1	8/2001	Shinriki et al.
10,229,851 B2	3/2019	Briggs et al.	2001/0019777 A1	9/2001	Tanaka et al.
10,236,177 B1	3/2019	Kohen et al.	2001/0019900 A1	9/2001	Hasegawa
10,249,524 B2	4/2019	den Hartog Besselink et al.	2001/0020715 A1	9/2001	Yamasaki
10,249,577 B2	4/2019	Lee et al.	2001/0021591 A1	9/2001	Srinivasan et al.
10,262,859 B2	4/2019	Margetis et al.	2001/0022215 A1	9/2001	Donohoe
10,269,558 B2	4/2019	Blanquart et al.	2001/0024387 A1	9/2001	Raaijmakers et al.
10,276,355 B2	4/2019	White et al.	2001/0027026 A1	10/2001	Dhindsa et al.
D849,055 S	5/2019	Kneip	2001/0028924 A1	10/2001	Sherman
D849,662 S	5/2019	Rike	2001/0031535 A1	10/2001	Agnello et al.
10,283,353 B2	5/2019	Kobayashi et al.	2001/0031541 A1	10/2001	Madan et al.
10,287,684 B2	5/2019	Yanai et al.	2001/0034097 A1	10/2001	Lim et al.
10,290,508 B1	5/2019	Kubota et al.	2001/0038783 A1	11/2001	Nakashima et al.
10,297,440 B2	5/2019	Yamazaki et al.	2001/0039922 A1	11/2001	Nakahara
RE47,440 E	6/2019	Yudovsky et al.	2001/0039966 A1	11/2001	Walpole et al.
10,312,055 B2	6/2019	Suzuki	2001/0040511 A1	11/2001	Bushner et al.
10,312,129 B2	6/2019	Coomer	2001/0041250 A1	11/2001	Werkhoven et al.
10,319,588 B2	6/2019	Mattinen et al.	2001/0042511 A1	11/2001	Liu et al.
10,322,384 B2	6/2019	Stumpf et al.	2001/0042594 A1	11/2001	Shamouilian et al.
10,332,963 B1	6/2019	Xie	2001/0046765 A1	11/2001	Cappellani et al.
D855,089 S	7/2019	Hopkins	2001/0047761 A1	12/2001	Wijck et al.
10,340,125 B2	7/2019	Winkler	2001/0048981 A1	12/2001	Suzuki
10,340,135 B2	7/2019	Blanquart	2001/0049080 A1	12/2001	Asano
10,343,920 B2	7/2019	Haukka	2001/0049202 A1	12/2001	Maeda et al.
10,347,547 B2	7/2019	Varadarajan et al.	2001/0054388 A1	12/2001	Qian
10,354,873 B2	7/2019	Ko et al.	2002/0000195 A1	1/2002	Bang et al.
10,361,201 B2	7/2019	Xie et al.	2002/0000202 A1	1/2002	Yuda et al.
10,361,366 B2	7/2019	Hakamata et al.	2002/0001971 A1	1/2002	Cho
10,367,080 B2	7/2019	Tang et al.	2002/0001974 A1	1/2002	Chan
10,388,513 B1	8/2019	Blanquart	2002/0001976 A1	1/2002	Danek
10,395,917 B2	8/2019	Niskanen et al.	2002/0005400 A1	1/2002	Gat et al.
10,395,919 B2	8/2019	Masaru et al.	2002/0005943 A1	1/2002	Voinalovich
D859,136 S	9/2019	Tenander et al.	2002/0008270 A1	1/2002	Marsh
10,400,335 B2	9/2019	Ge et al.	2002/0009119 A1	1/2002	Matthew et al.
10,410,943 B2	9/2019	Jiang et al.	2002/0009560 A1	1/2002	Ozono
D864,134 S	10/2019	Watarai et al.	2002/0009861 A1	1/2002	Narwankar et al.
10,428,419 B2	10/2019	Huotari et al.	2002/0011210 A1	1/2002	Satoh et al.
10,435,790 B2	10/2019	Fukazawa et al.	2002/0011211 A1	1/2002	Halpin
D867,867 S	11/2019	Tenander et al.	2002/0011310 A1	1/2002	Kamarehi et al.
10,468,244 B2	11/2019	Li et al.	2002/0013792 A1	1/2002	Imielinski et al.
10,468,251 B2	11/2019	Ishikawa et al.	2002/0014204 A1	2/2002	Pyo
10,483,154 B1	11/2019	Smith et al.	2002/0014483 A1	2/2002	Suzuki et al.
10,510,871 B1	12/2019	More et al.	2002/0016829 A1	2/2002	Defosse
10,529,554 B2	1/2020	Ishikawa et al.	2002/0020429 A1	2/2002	Selbrede et al.
D876,504 S	2/2020	Lee et al.	2002/0022347 A1	2/2002	Park et al.
10,590,531 B1	3/2020	Shirako et al.	2002/0023677 A1	2/2002	Zheng
10,600,637 B2	3/2020	Suzuki et al.	2002/0025688 A1	2/2002	Kato
D880,437 S	4/2020	Lee et al.	2002/0027945 A1	3/2002	Hirano et al.
D881,338 S *	4/2020	Chen D23/209	2002/0030047 A1	3/2002	Shao et al.
10,622,196 B2	4/2020	Nagayama et al.	2002/0031644 A1	3/2002	Malofsky et al.
			2002/0041931 A1	4/2002	Suntola et al.
			2002/0043337 A1	4/2002	Goodman et al.
			2002/0045336 A1	4/2002	Locati et al.
			2002/0048634 A1	4/2002	Basceri

(56)

References Cited

U.S. PATENT DOCUMENTS

2002/0050648	A1	5/2002	Kishida et al.	2003/0003719	A1	1/2003	Lim et al.
2002/0062633	A1	5/2002	Denker et al.	2003/0008528	A1	1/2003	Xia et al.
2002/0064592	A1	5/2002	Datta et al.	2003/0010355	A1	1/2003	Nowak et al.
2002/0064598	A1	5/2002	Wang et al.	2003/0010451	A1	1/2003	Tzu
2002/0066532	A1	6/2002	Shih et al.	2003/0010452	A1	1/2003	Park et al.
2002/0068458	A1	6/2002	Chiang et al.	2003/0012632	A1	1/2003	Saeki
2002/0069222	A1	6/2002	McNeely	2003/0013314	A1	1/2003	Ying et al.
2002/0073922	A1	6/2002	Frankel et al.	2003/0015141	A1	1/2003	Takagi
2002/0073923	A1	6/2002	Saito et al.	2003/0015294	A1	1/2003	Wang
2002/0076490	A1	6/2002	Chiang et al.	2003/0015596	A1	1/2003	Evans
2002/0076507	A1	6/2002	Chiang et al.	2003/0017265	A1	1/2003	Basceri et al.
2002/0076944	A1	6/2002	Wang et al.	2003/0017266	A1	1/2003	Basceri et al.
2002/0078893	A1	6/2002	Van Os et al.	2003/0017268	A1	1/2003	Hu
2002/0079714	A1	6/2002	Soucy et al.	2003/0019428	A1	1/2003	Ku et al.
2002/0081826	A1	6/2002	Rotondaro et al.	2003/0019580	A1	1/2003	Strang
2002/0086501	A1	7/2002	O'Donnell et al.	2003/0022468	A1	1/2003	Shioya et al.
2002/0088542	A1	7/2002	Nishikawa et al.	2003/0022523	A1	1/2003	Irino et al.
2002/0090735	A1	7/2002	Kishkovich et al.	2003/0023338	A1	1/2003	Chin et al.
2002/0094378	A1	7/2002	O'Donnell et al.	2003/0024901	A1	2/2003	Ishikawa
2002/0094388	A1	7/2002	Fonash et al.	2003/0025146	A1	2/2003	Narwankar et al.
2002/0096211	A1	7/2002	Zheng	2003/0026904	A1	2/2003	Yadav et al.
2002/0098627	A1	7/2002	Pomarede et al.	2003/0027431	A1	2/2003	Sneh et al.
2002/0099470	A1	7/2002	Zinger et al.	2003/0029303	A1	2/2003	Hasegawa et al.
2002/0100418	A1	8/2002	Sandhu et al.	2003/0029381	A1	2/2003	Nishibayashi
2002/0104481	A1	8/2002	Chiang et al.	2003/0029475	A1	2/2003	Hua et al.
2002/0104751	A1	8/2002	Drewery et al.	2003/0032297	A1	2/2003	Lindstrom et al.
2002/0108670	A1	8/2002	Baker et al.	2003/0035002	A1	2/2003	Moles
2002/0108714	A1	8/2002	Doering et al.	2003/0035705	A1	2/2003	Johnson
2002/0109115	A1	8/2002	Cederstav et al.	2003/0036272	A1	2/2003	Shamouilian et al.
2002/0110695	A1	8/2002	Yang et al.	2003/0037800	A1	2/2003	Bailey et al.
2002/0110991	A1	8/2002	Li	2003/0040120	A1	2/2003	Allen et al.
2002/0112114	A1	8/2002	Blair et al.	2003/0040158	A1	2/2003	Saitoh
2002/0114886	A1	8/2002	Chou et al.	2003/0040196	A1	2/2003	Lim et al.
2002/0115252	A1	8/2002	Haukka et al.	2003/0040841	A1	2/2003	Nasr et al.
2002/0117113	A1	8/2002	Tsuruno et al.	2003/0041971	A1	3/2003	Kido et al.
2002/0122885	A1	9/2002	Ahn	2003/0042419	A1	3/2003	Katsumata et al.
2002/0123200	A1	9/2002	Yamamoto et al.	2003/0045961	A1	3/2003	Nakao
2002/0123230	A1	9/2002	Hubacek	2003/0049372	A1	3/2003	Cook et al.
2002/0123237	A1	9/2002	Nguyen et al.	2003/0049375	A1	3/2003	Nguyen et al.
2002/0124883	A1	9/2002	Zheng	2003/0049499	A1	3/2003	Murakawa et al.
2002/0124906	A1	9/2002	Suzuki et al.	2003/0049580	A1	3/2003	Goodman
2002/0127350	A1	9/2002	Ishikawa et al.	2003/0049937	A1	3/2003	Suzuki
2002/0129768	A1	9/2002	Carpenter et al.	2003/0054670	A1	3/2003	Wang et al.
2002/0132408	A1	9/2002	Ma et al.	2003/0057848	A1	3/2003	Yuasa et al.
2002/0134511	A1	9/2002	Ushioda et al.	2003/0059535	A1	3/2003	Luo et al.
2002/0136214	A1	9/2002	Do et al.	2003/0059980	A1	3/2003	Chen et al.
2002/0136909	A1	9/2002	Yang	2003/0062359	A1	4/2003	Ho et al.
2002/0139775	A1	10/2002	Chang	2003/0065413	A1	4/2003	Liteplo et al.
2002/0146512	A1	10/2002	Rossmann	2003/0066482	A1	4/2003	Pokharna et al.
2002/0151327	A1	10/2002	Levitt	2003/0066541	A1	4/2003	Sun et al.
2002/0152244	A1	10/2002	Dean et al.	2003/0066826	A1	4/2003	Lee et al.
2002/0155219	A1	10/2002	Wang et al.	2003/0070617	A1	4/2003	Kim et al.
2002/0155708	A1	10/2002	Lo et al.	2003/0071015	A1	4/2003	Chinn et al.
2002/0157611	A1	10/2002	Bondestam et al.	2003/0072882	A1	4/2003	Niinisto et al.
2002/0160112	A1	10/2002	Sakai et al.	2003/0075925	A1	4/2003	Lindfors et al.
2002/0164420	A1	11/2002	Derderian et al.	2003/0077857	A1	4/2003	Xia et al.
2002/0164423	A1	11/2002	Chiang et al.	2003/0077883	A1	4/2003	Ohtake
2002/0168870	A1	11/2002	Matsuki	2003/0082296	A1	5/2003	Elers et al.
2002/0170676	A1	11/2002	Mitrovic et al.	2003/0082307	A1	5/2003	Chung et al.
2002/0172768	A1	11/2002	Endo et al.	2003/0085663	A1	5/2003	Horsky
2002/0174106	A1	11/2002	Martin	2003/0091938	A1	5/2003	Fairbairn et al.
2002/0179011	A1	12/2002	Jonnalagadda et al.	2003/0094133	A1	5/2003	Yoshidome et al.
2002/0181612	A1	12/2002	Warble et al.	2003/0101938	A1	6/2003	Ronsse et al.
2002/0184111	A1	12/2002	Swanson	2003/0109107	A1	6/2003	Hsieh et al.
2002/0187650	A1	12/2002	Blalock et al.	2003/0109951	A1	6/2003	Hsiung et al.
2002/0187656	A1	12/2002	Tan et al.	2003/0111013	A1	6/2003	Oosterlaken et al.
2002/0188376	A1	12/2002	Derderian et al.	2003/0111963	A1	6/2003	Tolmachev et al.
2002/0192370	A1	12/2002	Metzner et al.	2003/0113995	A1	6/2003	Xia et al.
2002/0197402	A1	12/2002	Chiang et al.	2003/0116087	A1	6/2003	Nguyen
2002/0197849	A1	12/2002	Mandal	2003/0121608	A1	7/2003	Chen
2003/0000647	A1	1/2003	Yudovsky et al.	2003/0124792	A1	7/2003	Jeon et al.
2003/0002562	A1	1/2003	Yerlikaya et al.	2003/0124818	A1	7/2003	Luo et al.
2003/0003607	A1	1/2003	Kagoshima	2003/0124820	A1	7/2003	Johnsgard et al.
2003/0003635	A1	1/2003	Paranjpe et al.	2003/0124842	A1	7/2003	Hytros et al.
2003/0003696	A1	1/2003	Gelatos et al.	2003/0127049	A1	7/2003	Han et al.
				2003/0132319	A1*	7/2003	Hytros C23C 16/45565 239/548
				2003/0133854	A1	7/2003	Tabata et al.
				2003/0134038	A1	7/2003	Paranjpe

(56)

References Cited

U.S. PATENT DOCUMENTS

2003/0140851	A1	7/2003	Janakiraman et al.	2004/0018307	A1	1/2004	Park et al.
2003/0141527	A1	7/2003	Joo et al.	2004/0018723	A1	1/2004	Byun et al.
2003/0141820	A1	7/2003	White et al.	2004/0018750	A1	1/2004	Sophie et al.
2003/0143328	A1	7/2003	Chen	2004/0023125	A1	2/2004	Nozawa et al.
2003/0145789	A1	8/2003	Bauch et al.	2004/0023516	A1	2/2004	Londergan et al.
2003/0149506	A1	8/2003	Haanstra et al.	2004/0025786	A1	2/2004	Kontani et al.
2003/0150386	A1	8/2003	Shimada	2004/0025787	A1	2/2004	Selbrede et al.
2003/0153177	A1	8/2003	Tepman et al.	2004/0026372	A1	2/2004	Takenaka et al.
2003/0153186	A1	8/2003	Bar-Gadda	2004/0029052	A1	2/2004	Park et al.
2003/0157345	A1	8/2003	Beldi et al.	2004/0031564	A1	2/2004	Gottscho et al.
2003/0157432	A1	8/2003	Rottsegge	2004/0035358	A1	2/2004	Basceri et al.
2003/0157436	A1	8/2003	Manger et al.	2004/0036129	A1	2/2004	Forbes et al.
2003/0159653	A1	8/2003	Dando et al.	2004/0037339	A1	2/2004	Watson et al.
2003/0159656	A1	8/2003	Tan	2004/0037675	A1	2/2004	Zinger et al.
2003/0162412	A1	8/2003	Chung	2004/0038525	A1	2/2004	Meng et al.
2003/0168001	A1	9/2003	Sneh	2004/0043149	A1	3/2004	Gordon et al.
2003/0168008	A1	9/2003	Ohmi et al.	2004/0043544	A1	3/2004	Asai et al.
2003/0168012	A1	9/2003	Tamura et al.	2004/0048439	A1	3/2004	Soman
2003/0168174	A1	9/2003	Foree	2004/0048452	A1	3/2004	Sugawara et al.
2003/0168699	A1	9/2003	Honda	2004/0048492	A1	3/2004	Ishikawa et al.
2003/0168750	A1	9/2003	Basceri et al.	2004/0050325	A1	3/2004	Samoilov
2003/0168948	A1	9/2003	Yamagishi et al.	2004/0050496	A1	3/2004	Iwai et al.
2003/0170153	A1	9/2003	Bar-Gadda	2004/0052972	A1	3/2004	Schmitt
2003/0170583	A1	9/2003	Nakashima	2004/0056017	A1	3/2004	Renken
2003/0170945	A1	9/2003	Igeta et al.	2004/0062081	A1	4/2004	Drewes
2003/0173030	A1	9/2003	Ishii et al.	2004/0063289	A1	4/2004	Ohta
2003/0173490	A1	9/2003	Lappen	2004/0065255	A1	4/2004	Yang et al.
2003/0176074	A1	9/2003	Paterson et al.	2004/0069226	A1	4/2004	Yoshida et al.
2003/0178145	A1	9/2003	Anderson et al.	2004/0071897	A1	4/2004	Verplancken et al.
2003/0180458	A1	9/2003	Sneh	2004/0077182	A1	4/2004	Lim et al.
2003/0183156	A1	10/2003	Dando	2004/0079286	A1	4/2004	Lindfors
2003/0183856	A1	10/2003	Wieczorek et al.	2004/0079960	A1	4/2004	Shakuda
2003/0188682	A1	10/2003	Tois et al.	2004/0080697	A1	4/2004	Song
2003/0188685	A1	10/2003	Wang	2004/0082171	A1	4/2004	Shin et al.
2003/0190804	A1	10/2003	Glenn et al.	2004/0083961	A1	5/2004	Basceri
2003/0192875	A1	10/2003	Bieker et al.	2004/0083964	A1	5/2004	Ingle et al.
2003/0198587	A1	10/2003	Kaloyeros	2004/0083975	A1	5/2004	Tong et al.
2003/0200926	A1	10/2003	Dando et al.	2004/0087141	A1	5/2004	Ramanathan et al.
2003/0201541	A1	10/2003	Kim	2004/0087168	A1	5/2004	Granneman et al.
2003/0205096	A1	11/2003	Gehner et al.	2004/0089078	A1	5/2004	Gehner et al.
2003/0205202	A1	11/2003	Funaki et al.	2004/0089236	A1	5/2004	Yokogawa et al.
2003/0205327	A1	11/2003	Howald et al.	2004/0092073	A1	5/2004	Cabral et al.
2003/0207032	A1	11/2003	Ahn et al.	2004/0092120	A1	5/2004	Wicker
2003/0209323	A1	11/2003	Yokogaki	2004/0093963	A1	5/2004	Gehner et al.
2003/0209326	A1	11/2003	Lee et al.	2004/0094206	A1	5/2004	Ishida
2003/0209746	A1	11/2003	Horii	2004/0094402	A1	5/2004	Gopalraja
2003/0210901	A1	11/2003	Donald et al.	2004/0095074	A1	5/2004	Ishii et al.
2003/0211735	A1	11/2003	Rossmann	2004/0099213	A1	5/2004	Adomaitis et al.
2003/0213435	A1	11/2003	Okuda et al.	2004/0099635	A1	5/2004	Nishikawa
2003/0213560	A1	11/2003	Wang et al.	2004/0101622	A1	5/2004	Park et al.
2003/0213562	A1	11/2003	Gondhalekar et al.	2004/0103914	A1	6/2004	Cheng et al.
2003/0215963	A1	11/2003	AmRhein et al.	2004/0105738	A1	6/2004	Ahn et al.
2003/0217915	A1	11/2003	Ouellet	2004/0106249	A1	6/2004	Huotari
2003/0219972	A1	11/2003	Green	2004/0115936	A1	6/2004	DePettillo et al.
2003/0221780	A1	12/2003	Lei et al.	2004/0118342	A1	6/2004	Cheng et al.
2003/0226840	A1	12/2003	Dalton	2004/0121620	A1	6/2004	Pomarede et al.
2003/0228772	A1	12/2003	Cowans	2004/0124131	A1	7/2004	Aitchison
2003/0230986	A1	12/2003	Horsky et al.	2004/0124549	A1	7/2004	Curran
2003/0231698	A1	12/2003	Yamaguchi	2004/0126213	A1	7/2004	Pelzmann et al.
2003/0232138	A1	12/2003	Tuominen et al.	2004/0126929	A1	7/2004	Tang et al.
2003/0232491	A1	12/2003	Yamaguchi	2004/0126990	A1	7/2004	Ohta
2003/0232511	A1	12/2003	Metzner et al.	2004/0127069	A1	7/2004	Yamazaki et al.
2003/0234371	A1	12/2003	Ziegler	2004/0129211	A1	7/2004	Blonigan et al.
2004/0002224	A1	1/2004	Chono et al.	2004/0129671	A1	7/2004	Ji et al.
2004/0005147	A1	1/2004	Wang et al.	2004/0134429	A1	7/2004	Yamanaka
2004/0005753	A1	1/2004	Kostamo et al.	2004/0137756	A1	7/2004	Li et al.
2004/0009307	A1	1/2004	Koh et al.	2004/0142577	A1	7/2004	Sugawara et al.
2004/0009679	A1	1/2004	Yeo et al.	2004/0144311	A1	7/2004	Chen
2004/0010772	A1	1/2004	McKenna et al.	2004/0144323	A1	7/2004	Kai
2004/0011504	A1	1/2004	Ku et al.	2004/0144980	A1	7/2004	Ahn et al.
2004/0013577	A1	1/2004	Ganguli et al.	2004/0146644	A1	7/2004	Xia et al.
2004/0013818	A1	1/2004	Moon et al.	2004/0151844	A1	8/2004	Zhang et al.
2004/0015300	A1	1/2004	Ganguli et al.	2004/0151845	A1	8/2004	Nguyen et al.
2004/0016637	A1	1/2004	Yang	2004/0152287	A1	8/2004	Sherrill et al.
2004/0018304	A1	1/2004	Chung et al.	2004/0159343	A1	8/2004	Shimbara et al.
				2004/0168627	A1	9/2004	Conley et al.
				2004/0168742	A1	9/2004	Kim et al.
				2004/0168769	A1	9/2004	Matsuoka et al.
				2004/0169032	A1	9/2004	Murayama et al.

(56)

References Cited

U.S. PATENT DOCUMENTS

2004/0185177	A1	9/2004	Basceri et al.	2005/0059261	A1	3/2005	Basceri et al.
2004/0187304	A1	9/2004	Chen et al.	2005/0059262	A1	3/2005	Yin et al.
2004/0187777	A1	9/2004	Okamoto et al.	2005/0059264	A1	3/2005	Cheung
2004/0187784	A1	9/2004	Sferlazzo	2005/0061964	A1	3/2005	Nagano et al.
2004/0187790	A1	9/2004	Bader	2005/0063451	A1	3/2005	Abe et al.
2004/0187928	A1	9/2004	Ambrosina	2005/0064207	A1	3/2005	Senzaki et al.
2004/0198069	A1	10/2004	Metzner et al.	2005/0064719	A1	3/2005	Liu
2004/0200499	A1	10/2004	Harvey et al.	2005/0066893	A1	3/2005	Soininen
2004/0202786	A1	10/2004	Wongsenakhum et al.	2005/0069651	A1	3/2005	Miyoshi
2004/0203251	A1	10/2004	Kawaguchi et al.	2005/0070123	A1	3/2005	Hirano
2004/0206305	A1	10/2004	Choi et al.	2005/0070128	A1	3/2005	Xia et al.
2004/0208228	A1	10/2004	Hashikura et al.	2005/0070729	A1	3/2005	Kiyomori et al.
2004/0209477	A1	10/2004	Buxbaum et al.	2005/0072357	A1	4/2005	Shero et al.
2004/0211357	A1	10/2004	Gadgil	2005/0074576	A1	4/2005	Chaiken et al.
2004/0212947	A1	10/2004	Nguyen	2005/0074983	A1	4/2005	Shinriki et al.
2004/0213921	A1	10/2004	Leu	2005/0079124	A1	4/2005	Sanderson
2004/0214399	A1	10/2004	Ahn et al.	2005/0079691	A1	4/2005	Kim et al.
2004/0214445	A1	10/2004	Shimizu et al.	2005/0092247	A1	5/2005	Schmidt
2004/0217217	A1	11/2004	Han et al.	2005/0092249	A1	5/2005	Kilpela et al.
2004/0219793	A1	11/2004	Hishiya et al.	2005/0092733	A1	5/2005	Ito et al.
2004/0220699	A1	11/2004	Heden et al.	2005/0095770	A1	5/2005	Kumagai et al.
2004/0221807	A1	11/2004	Vergheze et al.	2005/0095779	A1	5/2005	Park et al.
2004/0221808	A1	11/2004	Kawano	2005/0095859	A1	5/2005	Chen et al.
2004/0223893	A1	11/2004	Tabata et al.	2005/0098107	A1	5/2005	Du Bois et al.
2004/0226515	A1	11/2004	Yendler et al.	2005/0100669	A1	5/2005	Kools et al.
2004/0228968	A1	11/2004	Basceri	2005/0101154	A1	5/2005	Huang
2004/0231600	A1	11/2004	Lee	2005/0101843	A1	5/2005	Quinn et al.
2004/0231799	A1	11/2004	Lee et al.	2005/0106762	A1	5/2005	Chakrapani et al.
2004/0238523	A1	12/2004	Kuibira et al.	2005/0106893	A1	5/2005	Wilk
2004/0241322	A1	12/2004	Basceri et al.	2005/0107627	A1	5/2005	Dussarrat et al.
2004/0241998	A1	12/2004	Hanson	2005/0109461	A1	5/2005	Sun
2004/0245091	A1	12/2004	Karim et al.	2005/0110069	A1	5/2005	Kil et al.
2004/0247779	A1	12/2004	Selvamanickam et al.	2005/0112282	A1	5/2005	Gordon et al.
2004/0250600	A1	12/2004	Bevens et al.	2005/0115946	A1	6/2005	Shim et al.
2004/0253867	A1	12/2004	Matsumoto	2005/0118804	A1	6/2005	Byun et al.
2004/0261492	A1	12/2004	Zarkar et al.	2005/0118837	A1	6/2005	Todd
2004/0261712	A1	12/2004	Hayashi et al.	2005/0120805	A1	6/2005	Lane
2004/0261946	A1	12/2004	Endoh et al.	2005/0120962	A1	6/2005	Ushioda et al.
2004/0266011	A1	12/2004	Lee et al.	2005/0121145	A1	6/2005	Du Bois et al.
2005/0000428	A1	1/2005	Shero et al.	2005/0123690	A1	6/2005	Derderian et al.
2005/0001062	A1	1/2005	McCracken et al.	2005/0130427	A1	6/2005	Seok-Jun
2005/0003089	A1	1/2005	Won et al.	2005/0132957	A1	6/2005	El-Raghy
2005/0003600	A1	1/2005	Kasai et al.	2005/0133160	A1*	6/2005	Kennedy H01J 37/3244 156/345.34
2005/0003662	A1	1/2005	Jurisch et al.	2005/0133161	A1	6/2005	Carpenter et al.
2005/0008799	A1	1/2005	Tomiyasu et al.	2005/0136188	A1	6/2005	Chang
2005/0009325	A1	1/2005	Chung et al.	2005/0139160	A1	6/2005	Lei et al.
2005/0016470	A1	1/2005	Kang et al.	2005/0141591	A1	6/2005	Sakano
2005/0016956	A1	1/2005	Liu et al.	2005/0142361	A1	6/2005	Nakanishi
2005/0017272	A1	1/2005	Yamashita et al.	2005/0145338	A1	7/2005	Park et al.
2005/0019026	A1	1/2005	Wang et al.	2005/0148162	A1	7/2005	Chen et al.
2005/0019494	A1	1/2005	Moghadam et al.	2005/0150601	A1	7/2005	Srivastava
2005/0019960	A1	1/2005	Lee et al.	2005/0151184	A1	7/2005	Lee et al.
2005/0020071	A1	1/2005	Sonobe et al.	2005/0153571	A1	7/2005	Senzaki
2005/0023231	A1	2/2005	Huang et al.	2005/0160987	A1	7/2005	Kasai et al.
2005/0023624	A1	2/2005	Ahn et al.	2005/0161434	A1	7/2005	Sugawara et al.
2005/0026402	A1	2/2005	Jurgensen	2005/0172895	A1	8/2005	Kijima et al.
2005/0033075	A1	2/2005	Chi et al.	2005/0173003	A1	8/2005	Laverdiere et al.
2005/0034664	A1	2/2005	Koh et al.	2005/0175789	A1	8/2005	Helms
2005/0034674	A1	2/2005	Ono	2005/0178333	A1	8/2005	Loke et al.
2005/0037154	A1	2/2005	Koh et al.	2005/0181535	A1	8/2005	Yun et al.
2005/0037578	A1	2/2005	Chen et al.	2005/0181555	A1	8/2005	Haukka et al.
2005/0037610	A1	2/2005	Cha	2005/0183827	A1	8/2005	White et al.
2005/0037619	A1	2/2005	Granneman et al.	2005/0186688	A1	8/2005	Basceri
2005/0040144	A1	2/2005	Sellers	2005/0187647	A1	8/2005	Wang et al.
2005/0042778	A1	2/2005	Peukert	2005/0191828	A1	9/2005	Al-Bayati et al.
2005/0046825	A1	3/2005	Powell et al.	2005/0193948	A1	9/2005	Oohirabaru et al.
2005/0048797	A1	3/2005	Fukazawa	2005/0193952	A1	9/2005	Goodman et al.
2005/0051093	A1	3/2005	Makino et al.	2005/0199013	A1	9/2005	Vandroux et al.
2005/0051100	A1	3/2005	Chiang et al.	2005/0199342	A1	9/2005	Shajii et al.
2005/0051854	A1	3/2005	Cabral et al.	2005/0201908	A1	9/2005	Nakamura et al.
2005/0054175	A1	3/2005	Bauer	2005/0208217	A1	9/2005	Shinriki et al.
2005/0054198	A1	3/2005	Um	2005/0208219	A1	9/2005	Basceri
2005/0054228	A1	3/2005	March	2005/0208718	A1	9/2005	Lim et al.
2005/0056218	A1	3/2005	Sun et al.	2005/0211167	A1	9/2005	Gunji
2005/0056780	A1	3/2005	Miller et al.	2005/0211384	A1	9/2005	Hayashi
				2005/0212119	A1	9/2005	Shero
				2005/0214457	A1	9/2005	Schmitt et al.
				2005/0214458	A1	9/2005	Meiere

(56)

References Cited

U.S. PATENT DOCUMENTS

2005/0208778	A1	10/2005	Li	2006/0068097	A1	3/2006	Yamasaki et al.
2005/0218462	A1	10/2005	Ahn et al.	2006/0068104	A1	3/2006	Ishizaka
2005/0221021	A1	10/2005	Strang	2006/0068121	A1	3/2006	Lee et al.
2005/0221618	A1	10/2005	AmRhein et al.	2006/0068125	A1	3/2006	Radhakrishnan
2005/0223982	A1	10/2005	Park et al.	2006/0081558	A1	4/2006	Collins et al.
2005/0223994	A1	10/2005	Blomiley et al.	2006/0087638	A1	4/2006	Hirayanagi
2005/0227502	A1	10/2005	Schmitt et al.	2006/0090702	A1	5/2006	Koo et al.
2005/0229848	A1	10/2005	Shinriki	2006/0093756	A1	5/2006	Rajagopalan et al.
2005/0229849	A1	10/2005	Silvetti et al.	2006/0094236	A1	5/2006	Elkins et al.
2005/0229972	A1	10/2005	Hoshi et al.	2006/0096540	A1	5/2006	Choi
2005/0233477	A1	10/2005	Yamazaki et al.	2006/0099782	A1	5/2006	Ritenour
2005/0238807	A1	10/2005	Lin et al.	2006/0102968	A1	5/2006	Bojarczuk et al.
2005/0241176	A1	11/2005	Shero et al.	2006/0105566	A1	5/2006	Waldfried et al.
2005/0241763	A1	11/2005	Huang et al.	2006/0107898	A1	5/2006	Blomberg
2005/0241765	A1	11/2005	Dhindsa et al.	2006/0108221	A1	5/2006	Goodwin et al.
2005/0245058	A1	11/2005	Lee et al.	2006/0108331	A1	5/2006	Nozawa et al.
2005/0249876	A1	11/2005	Kawahara et al.	2006/0110930	A1	5/2006	Senzaki
2005/0250340	A1	11/2005	Chen et al.	2006/0110934	A1	5/2006	Fukuchi
2005/0251990	A1	11/2005	Choi	2006/0113038	A1	6/2006	Gondhalekar et al.
2005/0252447	A1	11/2005	Zhao et al.	2006/0113675	A1	6/2006	Chang et al.
2005/0252449	A1	11/2005	Nguyen et al.	2006/0113806	A1	6/2006	Tsuji et al.
2005/0252455	A1	11/2005	Moriya et al.	2006/0118240	A1	6/2006	Holber et al.
2005/0253061	A1	11/2005	Cameron et al.	2006/0118241	A1	6/2006	Ohmi et al.
2005/0255257	A1	11/2005	Choi et al.	2006/0125099	A1	6/2006	Gordon et al.
2005/0255327	A1	11/2005	Chaney et al.	2006/0127067	A1	6/2006	Wintenberger et al.
2005/0258280	A1	11/2005	Goto et al.	2006/0128142	A1	6/2006	Whelan et al.
2005/0260347	A1	11/2005	Narwankar et al.	2006/0128168	A1	6/2006	Ahn et al.
2005/0260837	A1	11/2005	Walther et al.	2006/0130751	A1	6/2006	Volfovski et al.
2005/0260850	A1	11/2005	Loke	2006/0130767	A1	6/2006	Herchen
2005/0263072	A1	12/2005	Balasubramanian et al.	2006/0137608	A1	6/2006	Choi et al.
2005/0263075	A1	12/2005	Wang et al.	2006/0137609	A1	6/2006	Puchacz et al.
2005/0263719	A1	12/2005	Ohdaira et al.	2006/0141155	A1	6/2006	Gordon et al.
2005/0263932	A1	12/2005	Heugel	2006/0144820	A1	7/2006	Sawin et al.
2005/0268856	A1	12/2005	Miller et al.	2006/0147626	A1	7/2006	Blomberg
2005/0271812	A1	12/2005	Myo et al.	2006/0148151	A1	7/2006	Murthy et al.
2005/0271813	A1	12/2005	Kher et al.	2006/0148180	A1	7/2006	Ahn et al.
2005/0272247	A1	12/2005	Ikeda et al.	2006/0151117	A1	7/2006	Kasanami et al.
2005/0274323	A1	12/2005	Seidel et al.	2006/0154424	A1	7/2006	Yang et al.
2005/0276928	A1	12/2005	Okumura et al.	2006/0156981	A1	7/2006	Fondurulia
2005/0277271	A1	12/2005	Beintner	2006/0162658	A1	7/2006	Weidman
2005/0282101	A1	12/2005	Adachi	2006/0162661	A1	7/2006	Jung et al.
2005/0282350	A1	12/2005	Chou et al.	2006/0162863	A1	7/2006	Kim et al.
2005/0284573	A1	12/2005	Egley et al.	2006/0163612	A1	7/2006	Kouvetakis et al.
2005/0284991	A1	12/2005	Saez	2006/0163683	A1	7/2006	Roth et al.
2005/0285097	A1	12/2005	Shang et al.	2006/0165892	A1	7/2006	Weidman
2005/0287725	A1	12/2005	Kitagawa	2006/0166428	A1	7/2006	Kamioka
2005/0287771	A1	12/2005	Seamons et al.	2006/0172531	A1	8/2006	Lin et al.
2006/0000411	A1	1/2006	Seo	2006/0175669	A1	8/2006	Kim et al.
2006/0006538	A1	1/2006	Allman et al.	2006/0177855	A1	8/2006	Utermohlen
2006/0009044	A1	1/2006	Igeta et al.	2006/0182885	A1	8/2006	Lei et al.
2006/0013674	A1	1/2006	Elliott et al.	2006/0185589	A1	8/2006	Zehavi et al.
2006/0013946	A1	1/2006	Park et al.	2006/0188360	A1	8/2006	Bonora et al.
2006/0014384	A1	1/2006	Lee et al.	2006/0191555	A1	8/2006	Yoshida et al.
2006/0014397	A1	1/2006	Seamons et al.	2006/0193979	A1	8/2006	Meiere et al.
2006/0016783	A1	1/2006	Wu et al.	2006/0193980	A1	8/2006	Hasegawa
2006/0019033	A1	1/2006	Muthukrishnan et al.	2006/0196418	A1	9/2006	Lindfors et al.
2006/0019502	A1	1/2006	Park et al.	2006/0196420	A1	9/2006	Ushakov et al.
2006/0021572	A1	2/2006	Wolden	2006/0196421	A1	9/2006	Ronsse et al.
2006/0021573	A1	2/2006	Monsma et al.	2006/0199357	A1	9/2006	Wan et al.
2006/0021703	A1	2/2006	Umotoy et al.	2006/0205194	A1	9/2006	Bauer
2006/0024439	A2	2/2006	Tuominen et al.	2006/0205223	A1	9/2006	Smayling
2006/0026314	A1	2/2006	Franchuk et al.	2006/0205231	A1	9/2006	Chou et al.
2006/0032443	A1	2/2006	Hasebe et al.	2006/0208215	A1	9/2006	Metzner et al.
2006/0040054	A1	2/2006	Pearlstein et al.	2006/0211243	A1	9/2006	Ishizaka et al.
2006/0040508	A1	2/2006	Ji	2006/0211259	A1	9/2006	Maes
2006/0046518	A1	3/2006	Hill et al.	2006/0213437	A1	9/2006	Ishizaka et al.
2006/0048710	A1	3/2006	Horiguchi et al.	2006/0213439	A1	9/2006	Ishizaka
2006/0051505	A1	3/2006	Kortshagen et al.	2006/0216942	A1	9/2006	Kim et al.
2006/0051520	A1	3/2006	Behle et al.	2006/0219169	A1	10/2006	Chen et al.
2006/0051925	A1	3/2006	Ahn et al.	2006/0219361	A1	10/2006	Wang et al.
2006/0057799	A1	3/2006	Horiguchi et al.	2006/0219363	A1	10/2006	Matsumoto et al.
2006/0057828	A1	3/2006	Omura	2006/0223301	A1	10/2006	Vanhaelemeersch et al.
2006/0060930	A1	3/2006	Metz et al.	2006/0223337	A1	10/2006	Ahn et al.
2006/0062910	A1	3/2006	Meiere	2006/0226117	A1	10/2006	Bertram et al.
2006/0063346	A1	3/2006	Lee et al.	2006/0228496	A1	10/2006	Choi
				2006/0228863	A1	10/2006	Zhang et al.
				2006/0228888	A1	10/2006	Lee et al.
				2006/0228898	A1	10/2006	Wajda et al.
				2006/0236934	A1	10/2006	Choi et al.

(56)

References Cited

U.S. PATENT DOCUMENTS

2006/0240187	A1	10/2006	Weidman	2007/0065578	A1	3/2007	McDougall
2006/0240574	A1	10/2006	Yoshie	2007/0066010	A1	3/2007	Ando
2006/0240662	A1	10/2006	Conley et al.	2007/0066038	A1	3/2007	Sadjadi et al.
2006/0247404	A1	11/2006	Todd	2007/0066079	A1	3/2007	Kolster et al.
2006/0249253	A1	11/2006	Dando	2007/0066084	A1	3/2007	Wajda et al.
2006/0251827	A1	11/2006	Nowak	2007/0074665	A1	4/2007	Chacin et al.
2006/0252228	A1	11/2006	Jeng	2007/0077355	A1	4/2007	Chacin et al.
2006/0252351	A1	11/2006	Kundracik	2007/0082132	A1	4/2007	Shinriki
2006/0254514	A1	11/2006	Kang et al.	2007/0082500	A1	4/2007	Norman et al.
2006/0257563	A1	11/2006	Doh et al.	2007/0082508	A1	4/2007	Chiang et al.
2006/0257584	A1	11/2006	Derderian et al.	2007/0084405	A1	4/2007	Kim
2006/0258078	A1	11/2006	Lee et al.	2007/0087296	A1	4/2007	Kim et al.
2006/0258173	A1	11/2006	Xiao et al.	2007/0087579	A1	4/2007	Kitayama et al.
2006/0260545	A1	11/2006	Ramaswamy et al.	2007/0089670	A1	4/2007	Ikedo
2006/0263522	A1	11/2006	Byun	2007/0095283	A1	5/2007	Galewski
2006/0263540	A1	11/2006	Ramaswamy et al.	2007/0095286	A1	5/2007	Baek et al.
2006/0264060	A1	11/2006	Ramaswamy et al.	2007/0096194	A1	5/2007	Streck et al.
2006/0264066	A1	11/2006	Bartholomew	2007/0098527	A1	5/2007	Hall et al.
2006/0266289	A1	11/2006	Vergheze et al.	2007/0107845	A1	5/2007	Ishizawa et al.
2006/0269690	A1	11/2006	Watanabe et al.	2007/0111470	A1	5/2007	Smythe
2006/0269692	A1	11/2006	Balseanu	2007/0111545	A1	5/2007	Lee et al.
2006/0275710	A1	12/2006	Yamazaki et al.	2007/0113788	A1	5/2007	Nozawa et al.
2006/0275933	A1	12/2006	Du Bois et al.	2007/0116872	A1	5/2007	Li et al.
2006/0278524	A1	12/2006	Stowell	2007/0116873	A1	5/2007	Li et al.
2006/0283629	A1	12/2006	Kikuchi et al.	2007/0116887	A1	5/2007	Faguet
2006/0286774	A1	12/2006	Singh et al.	2007/0116888	A1	5/2007	Faguet
2006/0286775	A1	12/2006	Singh et al.	2007/0119370	A1	5/2007	Ma et al.
2006/0286817	A1	12/2006	Kato et al.	2007/0120275	A1	5/2007	Liu
2006/0286818	A1	12/2006	Wang et al.	2007/0123037	A1	5/2007	Lee et al.
2006/0286819	A1	12/2006	Seutter	2007/0123189	A1	5/2007	Saito et al.
2006/0291982	A1	12/2006	Tanaka	2007/0125762	A1	6/2007	Cui et al.
2006/0292310	A1	12/2006	Le et al.	2007/0128538	A1	6/2007	Fairbairn et al.
2006/0292845	A1	12/2006	Chiang et al.	2007/0128570	A1	6/2007	Goto et al.
2007/0004204	A1	1/2007	Fukazawa et al.	2007/0128858	A1	6/2007	Haukka et al.
2007/0006806	A1	1/2007	Imai	2007/0128876	A1	6/2007	Fukiage
2007/0010072	A1	1/2007	Bailey et al.	2007/0128888	A1	6/2007	Goto et al.
2007/0012402	A1	1/2007	Sneh	2007/0129621	A1	6/2007	Kellogg et al.
2007/0014919	A1	1/2007	Hamalainen et al.	2007/0131168	A1	6/2007	Gomi et al.
2007/0020160	A1	1/2007	Berkman et al.	2007/0134821	A1	6/2007	Thakur et al.
2007/0020167	A1	1/2007	Han et al.	2007/0134919	A1	6/2007	Gunji et al.
2007/0020830	A1	1/2007	Speranza	2007/0134942	A1	6/2007	Ahn et al.
2007/0020953	A1	1/2007	Tsai et al.	2007/0137794	A1	6/2007	Qiu et al.
2007/0022954	A1	2/2007	Iizuka et al.	2007/0144442	A1	6/2007	Migita
2007/0026148	A1	2/2007	Arai et al.	2007/0146621	A1	6/2007	Yeom
2007/0026162	A1	2/2007	Wei et al.	2007/0148347	A1	6/2007	Hatanpaa et al.
2007/0026540	A1	2/2007	Nooten et al.	2007/0148350	A1	6/2007	Rahtu
2007/0028842	A1	2/2007	Inagawa et al.	2007/0148990	A1	6/2007	Deboer et al.
2007/0031598	A1	2/2007	Okuyama et al.	2007/0153625	A1	6/2007	Lundgren et al.
2007/0031599	A1	2/2007	Gschwandtner et al.	2007/0155138	A1	7/2007	Tomasini et al.
2007/0032004	A1	2/2007	Ramaswamy et al.	2007/0157466	A1	7/2007	Kida et al.
2007/0032045	A1	2/2007	Kasahara et al.	2007/0157683	A1	7/2007	Li
2007/0032054	A1	2/2007	Ramaswamy et al.	2007/0158026	A1	7/2007	Amikura
2007/0032082	A1	2/2007	Ramaswamy et al.	2007/0163440	A1	7/2007	Kim et al.
2007/0032095	A1	2/2007	Ramaswamy et al.	2007/0163625	A1	7/2007	Lee
2007/0034477	A1	2/2007	Inui	2007/0163996	A1	7/2007	Horiguchi
2007/0037343	A1	2/2007	Colombo et al.	2007/0166457	A1	7/2007	Yamoto et al.
2007/0037412	A1	2/2007	Dip et al.	2007/0166966	A1	7/2007	Todd et al.
2007/0042117	A1	2/2007	Kupurao et al.	2007/0166999	A1	7/2007	Vaarstra
2007/0042581	A1	2/2007	Sano et al.	2007/0170372	A1	7/2007	Horsky
2007/0044716	A1	3/2007	Tetsuka et al.	2007/0173071	A1	7/2007	Afzali-Ardakani et al.
2007/0045244	A1	3/2007	Lee et al.	2007/0175393	A1	8/2007	Nishimura et al.
2007/0047384	A1	3/2007	McLaughlin et al.	2007/0175397	A1	8/2007	Tomiyasu et al.
2007/0048953	A1	3/2007	Gealy et al.	2007/0178235	A1	8/2007	Yamada et al.
2007/0049053	A1	3/2007	Mahajani	2007/0181066	A1	8/2007	Cadwell et al.
2007/0051299	A1	3/2007	Ong et al.	2007/0184179	A1	8/2007	Waghray et al.
2007/0051312	A1	3/2007	Sneh	2007/0186849	A1	8/2007	Furuya
2007/0051471	A1	3/2007	Kawaguchi et al.	2007/0186952	A1	8/2007	Honda et al.
2007/0054049	A1	3/2007	Lindfors et al.	2007/0187362	A1	8/2007	Nakagawa et al.
2007/0054499	A1	3/2007	Jang	2007/0187363	A1	8/2007	Oka et al.
2007/0056843	A1	3/2007	Ye et al.	2007/0190266	A1	8/2007	Fu et al.
2007/0056850	A1	3/2007	Ye et al.	2007/0190362	A1	8/2007	Weidman
2007/0059948	A1	3/2007	Metzner et al.	2007/0190744	A1	8/2007	Hiraiwa et al.
2007/0062439	A1	3/2007	Wada et al.	2007/0190782	A1	8/2007	Park
2007/0062453	A1	3/2007	Ishikawa	2007/0199510	A1	8/2007	Weiner et al.
2007/0062646	A1	3/2007	Ogawa et al.	2007/0202678	A1	8/2007	Plombon et al.
				2007/0205788	A1	9/2007	Natsuhara et al.
				2007/0207275	A1	9/2007	Nowak et al.
				2007/0209588	A1	9/2007	Li et al.
				2007/0209590	A1	9/2007	Li

(56)

References Cited

U.S. PATENT DOCUMENTS

2007/0210890	A1	9/2007	Hsu et al.	2008/0043803	A1	2/2008	Bandoh
2007/0212484	A1	9/2007	Li	2008/0044938	A1	2/2008	England et al.
2007/0212811	A1	9/2007	Hanawa et al.	2008/0050536	A1	2/2008	Aing et al.
2007/0212827	A1	9/2007	Girotra et al.	2008/0050538	A1	2/2008	Hirata
2007/0215048	A1	9/2007	Suzuki et al.	2008/0054332	A1	3/2008	Kim et al.
2007/0215580	A1	9/2007	Koshiishi et al.	2008/0054813	A1	3/2008	Espiau et al.
2007/0218200	A1	9/2007	Suzuki et al.	2008/0056860	A1	3/2008	Natume
2007/0218705	A1	9/2007	Matsuki et al.	2008/0057659	A1	3/2008	Forbes et al.
2007/0222131	A1	9/2007	Fukumoto et al.	2008/0061667	A1	3/2008	Gaertner et al.
2007/0224777	A1	9/2007	Hamelin	2008/0063798	A1	3/2008	Kher et al.
2007/0224833	A1	9/2007	Morisada et al.	2008/0066778	A1	3/2008	Matsushita et al.
2007/0227665	A1	10/2007	Matsumoto et al.	2008/0067146	A1	3/2008	Onishi et al.
2007/0231488	A1	10/2007	Von Kaenel	2008/0069955	A1	3/2008	Hong et al.
2007/0232031	A1	10/2007	Singh et al.	2008/0072821	A1	3/2008	Dalton et al.
2007/0232071	A1	10/2007	Balseanu et al.	2008/0075562	A1	3/2008	Maria et al.
2007/0232501	A1	10/2007	Tomomura	2008/0075838	A1	3/2008	Inoue et al.
2007/0234955	A1	10/2007	Suzuki et al.	2008/0075881	A1	3/2008	Won et al.
2007/0237697	A1	10/2007	Clark	2008/0076070	A1	3/2008	Koh et al.
2007/0237698	A1	10/2007	Clark	2008/0076266	A1	3/2008	Fukazawa et al.
2007/0237699	A1	10/2007	Clark	2008/0076281	A1	3/2008	Ciancanelli et al.
2007/0238305	A1	10/2007	Delgadino et al.	2008/0081104	A1	4/2008	Hasebe et al.
2007/0241688	A1	10/2007	DeVacentis et al.	2008/0081113	A1	4/2008	Clark
2007/0243317	A1	10/2007	Du Bois et al.	2008/0081121	A1	4/2008	Morita et al.
2007/0247075	A1	10/2007	Kim et al.	2008/0083710	A1	4/2008	Chen et al.
2007/0248767	A1	10/2007	Okura	2008/0083948	A1	4/2008	Lin et al.
2007/0249131	A1	10/2007	Allen et al.	2008/0085226	A1	4/2008	Fondurulia et al.
2007/0251444	A1	11/2007	Gros-Jean et al.	2008/0085610	A1	4/2008	Wang et al.
2007/0251456	A1	11/2007	Herchen et al.	2008/0087218	A1	4/2008	Shimada et al.
2007/0252233	A1	11/2007	Yamazaki et al.	2008/0087642	A1	4/2008	Sawin et al.
2007/0252244	A1	11/2007	Srividya et al.	2008/0087890	A1	4/2008	Ahn et al.
2007/0252532	A1	11/2007	DeVacentis et al.	2008/0092815	A1	4/2008	Chen et al.
2007/0254414	A1	11/2007	Miyanami	2008/0092821	A1	4/2008	Otsuka et al.
2007/0258506	A1	11/2007	Schwagerman et al.	2008/0099147	A1	5/2008	Myo et al.
2007/0258855	A1	11/2007	Turcot et al.	2008/0102203	A1	5/2008	Wu
2007/0259778	A1	11/2007	Spencer et al.	2008/0102205	A1	5/2008	Barry et al.
2007/0261868	A1	11/2007	Gross	2008/0102208	A1	5/2008	Wu et al.
2007/0264427	A1	11/2007	Shinriki et al.	2008/0102603	A1	5/2008	Kobayashi et al.
2007/0264793	A1	11/2007	Oh et al.	2008/0102630	A1	5/2008	Saito
2007/0264807	A1	11/2007	Leone et al.	2008/0105276	A1	5/2008	Yeh et al.
2007/0266932	A1	11/2007	Hiramatsu	2008/0110401	A1	5/2008	Fujikawa et al.
2007/0266945	A1	11/2007	Shuto et al.	2008/0113094	A1	5/2008	Casper
2007/0269983	A1	11/2007	Sneh	2008/0113096	A1	5/2008	Mahajani
2007/0275166	A1	11/2007	Thridandam et al.	2008/0113097	A1	5/2008	Mahajani et al.
2007/0277735	A1	12/2007	Mokhesi et al.	2008/0118334	A1	5/2008	Bonora
2007/0281082	A1	12/2007	Mokhesi et al.	2008/0121177	A1	5/2008	Bang et al.
2007/0281105	A1	12/2007	Mokhesi et al.	2008/0121626	A1	5/2008	Thomas et al.
2007/0281106	A1	12/2007	Lubomirsky et al.	2008/0121962	A1	5/2008	Forbes et al.
2007/0281496	A1	12/2007	Ingle et al.	2008/0124197	A1	5/2008	van der Meulen et al.
2007/0286957	A1	12/2007	Suzuki et al.	2008/0124908	A1	5/2008	Forbes et al.
2007/0289534	A1	12/2007	Lubomirsky et al.	2008/0124945	A1	5/2008	Miya et al.
2007/0292974	A1	12/2007	Mizuno et al.	2008/0124946	A1	5/2008	Xiao et al.
2007/0295602	A1	12/2007	Tiller et al.	2008/0128726	A1	6/2008	Sakata et al.
2007/0298362	A1	12/2007	Rocha-Alvarez et al.	2008/0129209	A1	6/2008	Deakins et al.
2007/0298565	A1	12/2007	Nieh et al.	2008/0132046	A1	6/2008	Walther
2008/0003425	A1	1/2008	Spencer et al.	2008/0133154	A1	6/2008	Krauss et al.
2008/0003824	A1	1/2008	Padhi et al.	2008/0134887	A1	6/2008	Sherer
2008/0003838	A1	1/2008	Haukka et al.	2008/0142483	A1	6/2008	Hua
2008/0006208	A1	1/2008	Ueno et al.	2008/0146033	A1	6/2008	Park
2008/0018004	A1	1/2008	Steidl	2008/0149031	A1	6/2008	Chu et al.
2008/0020591	A1	1/2008	Balseanu et al.	2008/0149593	A1	6/2008	Bai et al.
2008/0020593	A1	1/2008	Wang et al.	2008/0152463	A1	6/2008	Chidambaram et al.
2008/0023436	A1	1/2008	Gros-Jean et al.	2008/0153308	A1	6/2008	Ogawa et al.
2008/0026162	A1	1/2008	Dickey et al.	2008/0153311	A1	6/2008	Padhi et al.
2008/0026574	A1	1/2008	Brcka	2008/0156769	A1	7/2008	Weiner et al.
2008/0026597	A1	1/2008	Munro et al.	2008/0157157	A1	7/2008	Tomomura
2008/0029790	A1	2/2008	Ahn et al.	2008/0157365	A1	7/2008	Ott et al.
2008/0031708	A1	2/2008	Bonora et al.	2008/0173237	A1	7/2008	Collins
2008/0035055	A1	2/2008	Dip et al.	2008/0173238	A1	7/2008	Nakashima et al.
2008/0035306	A1	2/2008	White et al.	2008/0173240	A1	7/2008	Furukawahara
2008/0035607	A1	2/2008	O'Hara et al.	2008/0173326	A1	7/2008	Gu et al.
2008/0036354	A1	2/2008	Letz et al.	2008/0176335	A1	7/2008	Alberti et al.
2008/0038485	A1	2/2008	Fukazawa et al.	2008/0176375	A1	7/2008	Erben et al.
2008/0038934	A1	2/2008	Vrtis et al.	2008/0176412	A1	7/2008	Komeda
2008/0042165	A1	2/2008	Sugizaki	2008/0178608	A1	7/2008	Tandou et al.
2008/0042192	A1	2/2008	Park et al.	2008/0178805	A1	7/2008	Paterson et al.
				2008/0179104	A1	7/2008	Zhang
				2008/0179291	A1	7/2008	Collins et al.
				2008/0179715	A1	7/2008	Coppa
				2008/0182075	A1	7/2008	Chopra

(56)

References Cited

U.S. PATENT DOCUMENTS

2008/0182390	A1	7/2008	Lemmi et al.	2009/0004875	A1	1/2009	Shen et al.
2008/0182411	A1	7/2008	Elers	2009/0011145	A1	1/2009	Yun
2008/0191193	A1	8/2008	Li et al.	2009/0011150	A1	1/2009	Jeon et al.
2008/0193643	A1	8/2008	Dip	2009/0011608	A1	1/2009	Nabatame
2008/0194105	A1	8/2008	Dominguez et al.	2009/0014879	A1	1/2009	Park et al.
2008/0194113	A1	8/2008	Kim et al.	2009/0017227	A1	1/2009	Fu et al.
2008/0194169	A1	8/2008	Sterling et al.	2009/0017631	A1	1/2009	Bencher
2008/0199977	A1	8/2008	Weigel et al.	2009/0017733	A1	1/2009	Takahashi et al.
2008/0202416	A1	8/2008	Provencher	2009/0020072	A1	1/2009	Mizunaga et al.
2008/0202689	A1	8/2008	Kim	2009/0023229	A1	1/2009	Matsushita
2008/0203487	A1	8/2008	Hohage et al.	2009/0029503	A1	1/2009	Arai
2008/0205483	A1	8/2008	Rempe et al.	2009/0029528	A1	1/2009	Sanchez et al.
2008/0210162	A1	9/2008	Yonebayashi	2009/0029564	A1	1/2009	Yamashita et al.
2008/0210278	A1	9/2008	Orii et al.	2009/0031954	A1	2/2009	Nishikido et al.
2008/0211423	A1	9/2008	Shinmen et al.	2009/0033907	A1	2/2009	Watson
2008/0211526	A1	9/2008	Shinma	2009/0035463	A1	2/2009	Dip
2008/0213696	A1	9/2008	Meeus et al.	2009/0035584	A1	2/2009	Tran et al.
2008/0214003	A1	9/2008	Xia et al.	2009/0035927	A1	2/2009	Olsen et al.
2008/0216077	A1	9/2008	Emani et al.	2009/0035947	A1	2/2009	Horii
2008/0216742	A1	9/2008	Takebayashi	2009/0036292	A1	2/2009	Sun et al.
2008/0216958	A1	9/2008	Goto et al.	2009/0039475	A1	2/2009	Shioya
2008/0220619	A1	9/2008	Matsushita et al.	2009/0041952	A1	2/2009	Yoon et al.
2008/0223130	A1	9/2008	Snell et al.	2009/0041984	A1	2/2009	Mayers et al.
2008/0224240	A1	9/2008	Ahn et al.	2009/0042344	A1	2/2009	Ye et al.
2008/0228306	A1	9/2008	Yetter et al.	2009/0042408	A1	2/2009	Maeda
2008/0229811	A1	9/2008	Zhao et al.	2009/0045749	A1	2/2009	Ganachev et al.
2008/0230371	A1	9/2008	McHugh	2009/0045829	A1	2/2009	Awazu
2008/0233288	A1	9/2008	Clark	2009/0047426	A1	2/2009	Park et al.
2008/0237572	A1	10/2008	Chui et al.	2009/0047433	A1	2/2009	Kim et al.
2008/0241052	A1	10/2008	Hooper et al.	2009/0047447	A1	2/2009	Sawin et al.
2008/0241384	A1	10/2008	Jeong	2009/0050621	A1	2/2009	Awazu
2008/0241387	A1	10/2008	Keto	2009/0052498	A1	2/2009	Halpin et al.
2008/0242116	A1	10/2008	Clark	2009/0053023	A1	2/2009	Wakabayashi
2008/0248310	A1	10/2008	Kim et al.	2009/0053900	A1	2/2009	Nozawa et al.
2008/0248597	A1	10/2008	Qin et al.	2009/0053906	A1	2/2009	Miya et al.
2008/0257102	A1	10/2008	Packer	2009/0056112	A1	3/2009	Kobayashi
2008/0257494	A1	10/2008	Hayashi et al.	2009/0056629	A1	3/2009	Katz et al.
2008/0260345	A1	10/2008	Mertesdorf et al.	2009/0057269	A1	3/2009	Katz et al.
2008/0260963	A1	10/2008	Yoon et al.	2009/0061083	A1	3/2009	Chiang et al.
2008/0261405	A1	10/2008	Yang et al.	2009/0061644	A1	3/2009	Chiang et al.
2008/0261413	A1	10/2008	Mahajani	2009/0061647	A1	3/2009	Mallick et al.
2008/0264337	A1	10/2008	Sano et al.	2009/0075490	A1	3/2009	Dussarrat
2008/0264443	A1	10/2008	Shrinivasan et al.	2009/0075491	A1	3/2009	Liu et al.
2008/0267598	A1	10/2008	Nakamura	2009/0081879	A1	3/2009	Sukekawa et al.
2008/0268171	A1	10/2008	Ma et al.	2009/0084317	A1	4/2009	Wu
2008/0268635	A1	10/2008	Yu et al.	2009/0085156	A1	4/2009	Dewey et al.
2008/0272424	A1	11/2008	Kim et al.	2009/0087585	A1	4/2009	Lee et al.
2008/0274369	A1	11/2008	Lee et al.	2009/0087964	A1	4/2009	Maeda et al.
2008/0276864	A1	11/2008	Koelmel et al.	2009/0087967	A1	4/2009	Todd
2008/0277647	A1	11/2008	Kouvetakis et al.	2009/0090382	A1	4/2009	Morisada
2008/0277656	A1	11/2008	Park et al.	2009/0093080	A1	4/2009	Choi et al.
2008/0277715	A1	11/2008	Ohmi et al.	2009/0093094	A1	4/2009	Ye et al.
2008/0282970	A1	11/2008	Heys et al.	2009/0093100	A1	4/2009	Xia et al.
2008/0283962	A1	11/2008	Dyer	2009/0095221	A1	4/2009	Tam et al.
2008/0286463	A1	11/2008	Tiner et al.	2009/0104351	A1	4/2009	Kakegawa
2008/0289574	A1	11/2008	Jacobs et al.	2009/0104594	A1	4/2009	Webb
2008/0289650	A1	11/2008	Arena	2009/0104789	A1	4/2009	Mallick et al.
2008/0289767	A1	11/2008	Tandou et al.	2009/0107404	A1	4/2009	Ogliari et al.
2008/0291964	A1	11/2008	Shrimpling	2009/0108308	A1	4/2009	Yang et al.
2008/0295872	A1	12/2008	Riker et al.	2009/0112458	A1	4/2009	Nakai
2008/0298945	A1	12/2008	Cox	2009/0115064	A1	5/2009	Sandhu et al.
2008/0299326	A1	12/2008	Fukazawa	2009/0116936	A1	5/2009	Marubayashi et al.
2008/0299758	A1	12/2008	Harada et al.	2009/0117717	A1	5/2009	Tomasini et al.
2008/0302303	A1	12/2008	Choi et al.	2009/0117746	A1	5/2009	Masuda
2008/0303744	A1	12/2008	Hirayama et al.	2009/0120580	A1	5/2009	Kagoshima et al.
2008/0305014	A1	12/2008	Honda	2009/0122293	A1	5/2009	Shibazaki
2008/0305246	A1	12/2008	Choi et al.	2009/0122458	A1	5/2009	Lischer et al.
2008/0305443	A1	12/2008	Nakamura	2009/0124131	A1	5/2009	Breunsbach et al.
2008/0314319	A1	12/2008	Hamano et al.	2009/0130331	A1	5/2009	Asai
2008/0314892	A1	12/2008	Graham	2009/0130859	A1	5/2009	Itatani et al.
2008/0315292	A1	12/2008	Ji et al.	2009/0136665	A1	5/2009	Choi et al.
2008/0317972	A1	12/2008	Hendriks	2009/0136668	A1	5/2009	Gregg et al.
2009/0000550	A1	1/2009	Tran et al.	2009/0136683	A1	5/2009	Fukasawa et al.
2009/0000551	A1	1/2009	Choi et al.	2009/0137055	A1	5/2009	Bognar
2009/0000769	A1	1/2009	Lin et al.	2009/0139657	A1	6/2009	Lee et al.
				2009/0142905	A1	6/2009	Yamazaki
				2009/0142933	A1	6/2009	Yajima et al.
				2009/0142935	A1	6/2009	Fukazawa et al.
				2009/0146322	A1	6/2009	Weling et al.

(56)

References Cited

U.S. PATENT DOCUMENTS

2009/0147819 A1	6/2009	Goodman et al.	2009/0308425 A1	12/2009	Yednak
2009/0155488 A1	6/2009	Nakano et al.	2009/0311857 A1	12/2009	Todd et al.
2009/0156015 A1	6/2009	Park et al.	2009/0314208 A1	12/2009	Zhou et al.
2009/0156017 A1	6/2009	Fukazawa et al.	2009/0315093 A1	12/2009	Li et al.
2009/0159000 A1	6/2009	Aggarwal et al.	2009/0317214 A1	12/2009	Hsiao et al.
2009/0159002 A1	6/2009	Bera et al.	2009/0320754 A1	12/2009	Oya
2009/0159424 A1	6/2009	Liu et al.	2009/0320881 A1	12/2009	Aitchison
2009/0162647 A1	6/2009	Sun et al.	2009/0324971 A1	12/2009	De Vries et al.
2009/0162996 A1	6/2009	Ramaswamy et al.	2009/0324989 A1	12/2009	Witz et al.
2009/0163038 A1	6/2009	Miyoshi	2009/0325391 A1	12/2009	De Vusser et al.
2009/0165715 A1	7/2009	Oh	2009/0325469 A1	12/2009	Koo et al.
2009/0165721 A1	7/2009	Pitney et al.	2010/0000608 A1	1/2010	Goto et al.
2009/0165722 A1	7/2009	Ha	2010/0001409 A1	1/2010	Humbert et al.
2009/0166616 A1	7/2009	Uchiyama	2010/0003406 A1	1/2010	Lam et al.
2009/0179365 A1	7/2009	Lerner et al.	2010/0006031 A1	1/2010	Choi et al.
2009/0183520 A1	7/2009	Yukimoto	2010/0006923 A1	1/2010	Fujitsuka
2009/0186479 A1	7/2009	Okabe et al.	2010/0008656 A1*	1/2010	Sorabji C23C 16/4557 392/416
2009/0186571 A1	7/2009	Haro	2010/0012036 A1	1/2010	Silva et al.
2009/0194233 A1	8/2009	Tamura et al.	2010/0014479 A1	1/2010	Kim
2009/0197015 A1	8/2009	Kudela et al.	2010/0015813 A1	1/2010	McGinnis et al.
2009/0197411 A1	8/2009	Dussarrat et al.	2010/0018460 A1	1/2010	Singh et al.
2009/0200494 A1	8/2009	Hatem	2010/0018913 A1	1/2010	Blum
2009/0200547 A1	8/2009	Griffin et al.	2010/0022097 A1	1/2010	Yamoto et al.
2009/0204403 A1	8/2009	Hollander et al.	2010/0024727 A1	2/2010	Kim et al.
2009/0206056 A1	8/2009	Xu	2010/0024872 A1	2/2010	Kishimoto
2009/0209081 A1	8/2009	Matero	2010/0025766 A1	2/2010	Nuttinck et al.
2009/0211523 A1	8/2009	Kuppurao et al.	2010/0025796 A1	2/2010	Dabiran
2009/0211525 A1	8/2009	Sarigiannis et al.	2010/0031884 A1	2/2010	Aggarwal et al.
2009/0214825 A1	8/2009	Sun et al.	2010/0032587 A1	2/2010	Hosch et al.
2009/0217871 A1	9/2009	Kim et al.	2010/0032842 A1	2/2010	Herd et al.
2009/0221149 A1	9/2009	Hammond et al.	2010/0034719 A1	2/2010	Dussarrat et al.
2009/0221151 A1	9/2009	Honda et al.	2010/0040441 A1	2/2010	Obikane
2009/0223441 A1	9/2009	Arena et al.	2010/0041179 A1	2/2010	Lee
2009/0227094 A1	9/2009	Bateman	2010/0041243 A1	2/2010	Cheng et al.
2009/0230211 A1	9/2009	Kobayashi et al.	2010/0046321 A1	2/2010	McLaughlin et al.
2009/0232985 A1	9/2009	Dussarrat et al.	2010/0050943 A1	3/2010	Kato et al.
2009/0236014 A1	9/2009	Wilson	2010/0051584 A1	3/2010	Okita et al.
2009/0236276 A1	9/2009	Kurth et al.	2010/0051597 A1	3/2010	Morita et al.
2009/0239386 A1	9/2009	Suzaki et al.	2010/0055312 A1	3/2010	Kato et al.
2009/0242130 A1	10/2009	Tian et al.	2010/0055316 A1	3/2010	Honma
2009/0242957 A1	10/2009	Ma et al.	2010/0055318 A1	3/2010	Volf et al.
2009/0246374 A1	10/2009	Vukovic	2010/0055442 A1	3/2010	Kellock
2009/0246399 A1	10/2009	Goundar	2010/0055898 A1	3/2010	Chang et al.
2009/0246971 A1	10/2009	Reid et al.	2010/0058984 A1	3/2010	Marubayashi
2009/0250004 A1	10/2009	Yamada et al.	2010/0065758 A1	3/2010	Liu et al.
2009/0250955 A1	10/2009	Aoki	2010/0068009 A1	3/2010	Kimura
2009/0255901 A1	10/2009	Okita	2010/0068383 A1	3/2010	Kato et al.
2009/0256127 A1	10/2009	Feist et al.	2010/0068414 A1	3/2010	Takahashi et al.
2009/0261331 A1	10/2009	Yang et al.	2010/0068891 A1	3/2010	Hatanaka et al.
2009/0266296 A1	10/2009	Tachibana et al.	2010/0075037 A1	3/2010	Marsh et al.
2009/0267135 A1	10/2009	Tanaka et al.	2010/0075488 A1	3/2010	Collins et al.
2009/0267225 A1	10/2009	Eguchi	2010/0075507 A1	3/2010	Chang et al.
2009/0269506 A1	10/2009	Okura et al.	2010/0078601 A1	4/2010	Pallem et al.
2009/0269507 A1	10/2009	Yu et al.	2010/0078746 A1	4/2010	Jung
2009/0269941 A1	10/2009	Raisanen	2010/0081094 A1	4/2010	Hasebe et al.
2009/0275205 A1	11/2009	Kiehlbauch et al.	2010/0081293 A1	4/2010	Mallick et al.
2009/0275210 A1	11/2009	Shanker et al.	2010/0086703 A1	4/2010	Mangum et al.
2009/0277510 A1	11/2009	Shikata	2010/0087069 A1	4/2010	Miya et al.
2009/0277874 A1	11/2009	Rui et al.	2010/0089320 A1	4/2010	Kim
2009/0280248 A1	11/2009	Goodman et al.	2010/0089870 A1	4/2010	Hiroshima et al.
2009/0283041 A1	11/2009	Tomiyasu et al.	2010/0090149 A1	4/2010	Thompson et al.
2009/0283217 A1	11/2009	Lubomirsky et al.	2010/0092679 A1	4/2010	Lee et al.
2009/0284156 A1	11/2009	Banna et al.	2010/0092696 A1	4/2010	Shinriki
2009/0286400 A1	11/2009	Heo et al.	2010/0093187 A1	4/2010	Lee et al.
2009/0286402 A1	11/2009	Xia et al.	2010/0094430 A1	4/2010	Krumdieck
2009/0286405 A1	11/2009	Okesaku et al.	2010/0098862 A1	4/2010	Xu et al.
2009/0289300 A1	11/2009	Sasaki et al.	2010/0101728 A1	4/2010	Iwasaki
2009/0291208 A1	11/2009	Gordon et al.	2010/0102417 A1	4/2010	Ganguli et al.
2009/0297710 A1	12/2009	Lindfors	2010/0105936 A1	4/2010	Tada et al.
2009/0297731 A1	12/2009	Goundar	2010/0111648 A1	5/2010	Tamura et al.
2009/0298257 A1	12/2009	Lee et al.	2010/0112496 A1	5/2010	Nakajima et al.
2009/0302002 A1	12/2009	Collins et al.	2010/0116207 A1	5/2010	Givens
2009/0302434 A1	12/2009	Pallem et al.	2010/0116208 A1	5/2010	Sangam
2009/0304558 A1	12/2009	Patton	2010/0116209 A1	5/2010	Kato
2009/0308315 A1	12/2009	de Ridder	2010/0119439 A1	5/2010	Shindou
			2010/0119727 A1	5/2010	Takagi
			2010/0120261 A1	5/2010	Kim et al.
			2010/0124610 A1	5/2010	Aikawa et al.

(56)

References Cited

U.S. PATENT DOCUMENTS

2010/0124618	A1	5/2010	Kobayashi et al.	2010/0246630	A1	11/2010	Kaszynski et al.
2010/0124621	A1	5/2010	Kobayashi et al.	2010/0275846	A1	11/2010	Kitagawa
2010/0126415	A1	5/2010	Ishino et al.	2010/0279008	A1	11/2010	Takagi
2010/0126539	A1	5/2010	Lee et al.	2010/0279512	A1	11/2010	Udea et al.
2010/0126605	A1	5/2010	Stones	2010/0282163	A1	11/2010	Aggarwal et al.
2010/0126666	A1	5/2010	Tandou et al.	2010/0282170	A1	11/2010	Nishizawa
2010/0129548	A1	5/2010	Sneh	2010/0282645	A1	11/2010	Wang
2010/0129990	A1	5/2010	Nishizawa et al.	2010/0285237	A1	11/2010	Ditizio et al.
2010/0130015	A1	5/2010	Nakajima et al.	2010/0285319	A1	11/2010	Kwak et al.
2010/0130017	A1	5/2010	Luo et al.	2010/0294199	A1	11/2010	Tran et al.
2010/0130105	A1	5/2010	Lee	2010/0297391	A1	11/2010	Kley
2010/0133255	A1	6/2010	Bahng et al.	2010/0301752	A1	12/2010	Bakre et al.
2010/0134023	A1	6/2010	Mills	2010/0304047	A1	12/2010	Yang et al.
2010/0136216	A1	6/2010	Tsuei et al.	2010/0307415	A1	12/2010	Shero et al.
2010/0140221	A1	6/2010	Kikuchi et al.	2010/0317177	A1	12/2010	Huang et al.
2010/0140684	A1	6/2010	Ozawa	2010/0317198	A1	12/2010	Antonelli
2010/0143609	A1	6/2010	Fukazawa et al.	2010/0322604	A1	12/2010	Fondurulia et al.
2010/0144150	A1	6/2010	Sills et al.	2010/0326358	A1	12/2010	Choi
2010/0144162	A1	6/2010	Lee et al.	2011/0000619	A1	1/2011	Suh
2010/0144968	A1	6/2010	Lee et al.	2011/0003087	A1	1/2011	Soininen et al.
2010/0145547	A1	6/2010	Darabnia et al.	2011/0003450	A1	1/2011	Lee et al.
2010/0147396	A1	6/2010	Yamagishi et al.	2011/0005684	A1	1/2011	Hayami et al.
2010/0151206	A1	6/2010	Wu et al.	2011/0006402	A1	1/2011	Zhou
2010/0159638	A1	6/2010	Jeong	2011/0006406	A1	1/2011	Urbanowicz et al.
2010/0159707	A1	6/2010	Huang et al.	2011/0008950	A1	1/2011	Xu
2010/0162752	A1	7/2010	Tabata et al.	2011/0014359	A1	1/2011	Hashim
2010/0162956	A1	7/2010	Murakami et al.	2011/0014795	A1	1/2011	Lee
2010/0163524	A1	7/2010	Arai	2011/0017139	A1	1/2011	Chiang et al.
2010/0163937	A1	7/2010	Clendenning	2011/0021033	A1	1/2011	Ikeuchi et al.
2010/0166630	A1	7/2010	Gu et al.	2011/0027725	A1	2/2011	Tsutsumi et al.
2010/0168404	A1	7/2010	Girolami et al.	2011/0027999	A1	2/2011	Sparks et al.
2010/0170441	A1	7/2010	Won et al.	2011/0031562	A1	2/2011	Lin et al.
2010/0170868	A1	7/2010	Lin et al.	2011/0034039	A1	2/2011	Liang et al.
2010/0173432	A1	7/2010	White et al.	2011/0039419	A1	2/2011	Date et al.
2010/0178137	A1	7/2010	Chintalapati et al.	2011/0041764	A1	2/2011	Webb et al.
2010/0178423	A1	7/2010	Shimizu et al.	2011/0042200	A1	2/2011	Wilby
2010/0180819	A1	7/2010	Hatanaka et al.	2011/0045610	A1	2/2011	van Schravendijk
2010/0183825	A1	7/2010	Becker et al.	2011/0045676	A1	2/2011	Park et al.
2010/0184302	A1	7/2010	Lee et al.	2011/0046314	A1	2/2011	Klipp et al.
2010/0186669	A1	7/2010	Shin et al.	2011/0048642	A1	3/2011	Mihara et al.
2010/0189923	A1	7/2010	Goundar et al.	2011/0048769	A1	3/2011	Fujiwara
2010/0193501	A1	8/2010	Zucker et al.	2011/0049100	A1	3/2011	Han et al.
2010/0193955	A1	8/2010	Milligan et al.	2011/0052833	A1	3/2011	Hanawa et al.
2010/0195392	A1	8/2010	Freeman	2011/0053383	A1	3/2011	Shero et al.
2010/0197107	A1	8/2010	Matsuzaki	2011/0056513	A1	3/2011	Hombach et al.
2010/0202860	A1	8/2010	Reed	2011/0056626	A1	3/2011	Brown et al.
2010/0203242	A1	8/2010	Borden	2011/0057248	A1	3/2011	Ma et al.
2010/0206767	A1	8/2010	Odashima et al.	2011/0061810	A1	3/2011	Ganguly et al.
2010/0209598	A1	8/2010	Xu et al.	2011/0065289	A1	3/2011	Asai
2010/0210108	A1	8/2010	Ishizaka et al.	2011/0067522	A1	3/2011	Lai
2010/0219757	A1	9/2010	Benzerrouk et al.	2011/0070380	A1	3/2011	Shero et al.
2010/0221452	A1	9/2010	Kang	2011/0070740	A1	3/2011	Bettencourt et al.
2010/0224130	A1	9/2010	Smith et al.	2011/0076401	A1	3/2011	Chao et al.
2010/0227458	A1	9/2010	Chung et al.	2011/0081519	A1	4/2011	Dillingh
2010/0229795	A1	9/2010	Tanabe	2011/0083496	A1	4/2011	Lin et al.
2010/0229965	A1	9/2010	Kashima et al.	2011/0086516	A1	4/2011	Lee et al.
2010/0230051	A1	9/2010	Iizuka	2011/0089166	A1	4/2011	Hunter et al.
2010/0230863	A1	9/2010	Moench et al.	2011/0089469	A1	4/2011	Merckling
2010/0233885	A1	9/2010	Kushibiki et al.	2011/0092077	A1	4/2011	Xu et al.
2010/0233886	A1	9/2010	Yang et al.	2011/0097901	A1	4/2011	Banna et al.
2010/0236691	A1	9/2010	Yamazaki	2011/0098841	A1	4/2011	Tsuda
2010/0243166	A1	9/2010	Hayashi et al.	2011/0100489	A1	5/2011	Orito et al.
2010/0244688	A1	9/2010	Braun et al.	2011/0104395	A1	5/2011	Kumagai et al.
2010/0248465	A1	9/2010	Yi et al.	2011/0107512	A1	5/2011	Gilbert
2010/0252434	A1	10/2010	Roy	2011/0108194	A1	5/2011	Yoshioka et al.
2010/0255196	A1	10/2010	Geisler et al.	2011/0108424	A1	5/2011	Puget et al.
2010/0255198	A1	10/2010	Cleary et al.	2011/0108741	A1	5/2011	Ingram
2010/0255218	A1	10/2010	Oka et al.	2011/0108929	A1	5/2011	Meng
2010/0255625	A1	10/2010	De Vries	2011/0114261	A1	5/2011	Matsumoto et al.
2010/0255658	A1	10/2010	Aggarwal	2011/0114601	A1	5/2011	Lubomirsky et al.
2010/0259152	A1	10/2010	Yasuda et al.	2011/0115378	A1	5/2011	Lubomirsky et al.
2010/0266765	A1	10/2010	White et al.	2011/0117490	A1	5/2011	Bae et al.
2010/0267224	A1	10/2010	Choi et al.	2011/0117492	A1	5/2011	Yamada et al.
2010/0267248	A1	10/2010	Ma et al.	2011/0117732	A1	5/2011	Bauer et al.
2010/0270675	A1	10/2010	Harada	2011/0117737	A1	5/2011	Agarwala et al.
				2011/0117749	A1	5/2011	Sheu
				2011/0121503	A1	5/2011	Burrows et al.
				2011/0121736	A1	5/2011	Hirayama et al.
				2011/0124196	A1	5/2011	Lee

(56)

References Cited

U.S. PATENT DOCUMENTS

2011/0127702	A1	6/2011	Gautam et al.	2011/0300720	A1	12/2011	Fu
2011/0132542	A1	6/2011	Ilzuka	2011/0305102	A1	12/2011	Berger et al.
2011/0135842	A1	6/2011	Faguet et al.	2011/0308453	A1	12/2011	Su et al.
2011/0139272	A1	6/2011	Matsumoto et al.	2011/0308460	A1	12/2011	Hong et al.
2011/0139748	A1	6/2011	Donnelly et al.	2011/0312191	A1	12/2011	Ohkura et al.
2011/0140172	A1	6/2011	Chu	2011/0318142	A1	12/2011	Gage et al.
2011/0140173	A1	6/2011	Ramdani	2011/0318888	A1	12/2011	Komatsu et al.
2011/0143032	A1	6/2011	Vrtis et al.	2011/0318935	A1	12/2011	Oyabu et al.
2011/0143461	A1	6/2011	Fish et al.	2012/0001172	A1	1/2012	Shang et al.
2011/0155264	A1	6/2011	Minami et al.	2012/0003500	A1	1/2012	Yoshida et al.
2011/0155322	A1	6/2011	Himori et al.	2012/0003599	A1	1/2012	Patalay et al.
2011/0159200	A1	6/2011	Kogure	2012/0003726	A1	1/2012	Jones et al.
2011/0159202	A1	6/2011	Matsushita	2012/0003831	A1	1/2012	Kang et al.
2011/0159673	A1	6/2011	Hanawa et al.	2012/0006489	A1	1/2012	Okita
2011/0159680	A1	6/2011	Yoo	2012/0009802	A1	1/2012	Lavoie
2011/0168330	A1	7/2011	Sakaue et al.	2012/0012556	A1	1/2012	Matsumoto et al.
2011/0171380	A1	7/2011	Higashi et al.	2012/0021252	A1	1/2012	Lee
2011/0171775	A1	7/2011	Yamamoto et al.	2012/0024223	A1	2/2012	Torres et al.
2011/0175011	A1	7/2011	Ehrne et al.	2012/0024227	A1	2/2012	Takasuka et al.
2011/0177648	A1	7/2011	Tanner et al.	2012/0024231	A1	2/2012	Horino
2011/0180233	A1	7/2011	Bera et al.	2012/0024478	A1	2/2012	Huang et al.
2011/0183079	A1	7/2011	Jackson et al.	2012/0024479	A1	2/2012	Palagashvili et al.
2011/0183269	A1	7/2011	Zhu	2012/0027547	A1	2/2012	Jager et al.
2011/0183527	A1	7/2011	Cho	2012/0028454	A1	2/2012	Swaminathan et al.
2011/0185969	A1	8/2011	Yang	2012/0028469	A1	2/2012	Onizawa et al.
2011/0192820	A1	8/2011	Yeom et al.	2012/0031333	A1	2/2012	Kurita et al.
2011/0195574	A1	8/2011	Blasco et al.	2012/0031500	A1	2/2012	Hirose et al.
2011/0198034	A1	8/2011	Sun et al.	2012/0032311	A1	2/2012	Gates
2011/0198417	A1	8/2011	Detmar et al.	2012/0033695	A1	2/2012	Hayashi et al.
2011/0198736	A1	8/2011	Shero et al.	2012/0034793	A1	2/2012	Narushima et al.
2011/0204025	A1	8/2011	Tahara	2012/0036732	A1	2/2012	Varadarajan
2011/0207332	A1	8/2011	Liu et al.	2012/0040097	A1	2/2012	Volf et al.
2011/0210468	A1	9/2011	Shannon et al.	2012/0040528	A1	2/2012	Kim et al.
2011/0217838	A1	9/2011	Hsieh et al.	2012/0043556	A1	2/2012	Dube et al.
2011/0220874	A1	9/2011	Hanrath	2012/0043617	A1	2/2012	Nakagawa et al.
2011/0223334	A1	9/2011	Yudovsky et al.	2012/0046421	A1	2/2012	Darling et al.
2011/0226421	A1	9/2011	Hayashi	2012/0052681	A1	3/2012	Marsh
2011/0232678	A1	9/2011	Shih et al.	2012/0058270	A1	3/2012	Winter et al.
2011/0236201	A1	9/2011	Shende	2012/0058630	A1	3/2012	Quinn
2011/0236594	A1	9/2011	Haverkamp et al.	2012/0064690	A1	3/2012	Hirota et al.
2011/0236600	A1	9/2011	Fox et al.	2012/0064726	A1	3/2012	Nozawa et al.
2011/0237040	A1	9/2011	Ng et al.	2012/0064764	A1	3/2012	Islam
2011/0239936	A1	10/2011	Suzaki et al.	2012/0068242	A1	3/2012	Shin et al.
2011/0239940	A1	10/2011	Benvenuti et al.	2012/0070136	A1	3/2012	Koelmel et al.
2011/0244673	A1	10/2011	Cho et al.	2012/0070997	A1	3/2012	Larson
2011/0253044	A1	10/2011	Tam et al.	2012/0073400	A1	3/2012	Wang
2011/0254052	A1	10/2011	Kouvetakis	2012/0074533	A1	3/2012	Aoyama
2011/0256675	A1	10/2011	Avouris	2012/0077349	A1	3/2012	Li et al.
2011/0256692	A1	10/2011	Tam et al.	2012/0080756	A1	4/2012	Suzuki
2011/0256724	A1	10/2011	Chandrasekharan et al.	2012/0083134	A1	4/2012	Wu et al.
2011/0256726	A1	10/2011	Lavoie et al.	2012/0088031	A1	4/2012	Neel
2011/0256727	A1	10/2011	Beynet et al.	2012/0090704	A1	4/2012	Laverdiere et al.
2011/0256734	A1	10/2011	Hausmann et al.	2012/0091522	A1	4/2012	Ozaki et al.
2011/0259519	A1	10/2011	Kenworthy et al.	2012/0094468	A1	4/2012	Bhatia et al.
2011/0262642	A1	10/2011	Xiao et al.	2012/0098107	A1	4/2012	Raisanen et al.
2011/0263107	A1	10/2011	Chung et al.	2012/0100464	A1	4/2012	Kageyama
2011/0263115	A1	10/2011	Ganguli et al.	2012/0103264	A1	5/2012	Choi et al.
2011/0264250	A1	10/2011	Nishimura et al.	2012/0103522	A1	5/2012	Hohenwarter
2011/0265549	A1	11/2011	Cruse et al.	2012/0103939	A1	5/2012	Wu et al.
2011/0265715	A1	11/2011	Keller	2012/0104514	A1	5/2012	Park et al.
2011/0265725	A1	11/2011	Tsuji	2012/0107607	A1	5/2012	Takaki et al.
2011/0265951	A1	11/2011	Xu et al.	2012/0108039	A1	5/2012	Zajaji
2011/0266611	A1	11/2011	Kim et al.	2012/0108048	A1	5/2012	Lim et al.
2011/0269314	A1	11/2011	Lee et al.	2012/0114877	A1	5/2012	Lee
2011/0275018	A1	11/2011	Matteo et al.	2012/0115250	A1	5/2012	Ariga et al.
2011/0275166	A1	11/2011	Shero et al.	2012/0115257	A1	5/2012	Matsuyam et al.
2011/0277690	A1	11/2011	Rozenzon et al.	2012/0119337	A1	5/2012	Sasaki et al.
2011/0281417	A1	11/2011	Gordon et al.	2012/0121823	A1	5/2012	Chhabra
2011/0283933	A1	11/2011	Makarov et al.	2012/0122275	A1	5/2012	Koo et al.
2011/0286819	A1	11/2011	Shibata et al.	2012/0122302	A1	5/2012	Weisman et al.
2011/0291243	A1	12/2011	Seamons	2012/0122319	A1	5/2012	Shimizu
2011/0294075	A1	12/2011	Chen et al.	2012/0125258	A1	5/2012	Lee
2011/0294288	A1	12/2011	Lee et al.	2012/0126300	A1	5/2012	Park et al.
2011/0297088	A1	12/2011	Song et al.	2012/0128897	A1	5/2012	Xiao et al.
2011/0298062	A1	12/2011	Ganguli et al.	2012/0135145	A1	5/2012	Je et al.
				2012/0139009	A1	6/2012	Ning et al.
				2012/0145078	A1	6/2012	Huang et al.
				2012/0146113	A1	6/2012	Suzuki et al.
				2012/0149207	A1	6/2012	Graff

(56)

References Cited

U.S. PATENT DOCUMENTS

2012/0149213	A1	6/2012	Nittala	2012/0305026	A1	12/2012	Nomura et al.
2012/0156108	A1	6/2012	Fondurulia et al.	2012/0305196	A1	12/2012	Mori et al.
2012/0156890	A1	6/2012	Yim et al.	2012/0305987	A1	12/2012	Hirler et al.
2012/0160172	A1	6/2012	Wamura et al.	2012/0307588	A1	12/2012	Hanada et al.
2012/0160809	A1	6/2012	Ishibashi et al.	2012/0309181	A1	12/2012	Machkaoutsan et al.
2012/0161126	A1	6/2012	Yamazaki	2012/0310440	A1	12/2012	Darabnia et al.
2012/0161405	A1	6/2012	Mohn	2012/0315113	A1	12/2012	Hiroki
2012/0164327	A1	6/2012	Sato	2012/0315404	A1	12/2012	Li et al.
2012/0164837	A1	6/2012	Tan et al.	2012/0318334	A1	12/2012	Bedell et al.
2012/0164842	A1	6/2012	Watanabe	2012/0318457	A1	12/2012	Nguyen et al.
2012/0164846	A1	6/2012	Ha et al.	2012/0318773	A1	12/2012	Wu et al.
2012/0170170	A1	7/2012	Gros-Jean	2012/0319279	A1	12/2012	Isobayashi
2012/0171391	A1	7/2012	Won	2012/0320491	A1	12/2012	Doh et al.
2012/0171874	A1	7/2012	Thridandam et al.	2012/0321786	A1	12/2012	Satitpunwaycha et al.
2012/0175518	A1	7/2012	Godet et al.	2012/0322252	A1	12/2012	Son et al.
2012/0175751	A1	7/2012	Gatineau et al.	2012/0325148	A1	12/2012	Yamagishi et al.
2012/0177845	A1	7/2012	Odedra et al.	2012/0328780	A1	12/2012	Yamagishi et al.
2012/0180719	A1	7/2012	Inoue et al.	2013/0002121	A1	1/2013	Ma
2012/0180954	A1	7/2012	Yang et al.	2013/0005122	A1	1/2013	Schwarzenbach et al.
2012/0183689	A1	7/2012	Suzuki et al.	2013/0005147	A1	1/2013	Angyal et al.
2012/0186521	A1	7/2012	Iwasaki et al.	2013/0008607	A1	1/2013	Matsumoto et al.
2012/0186573	A1	7/2012	Jdira et al.	2013/0011983	A1	1/2013	Tsai
2012/0187083	A1	7/2012	Hashizume	2013/0011984	A1	1/2013	Wang et al.
2012/0187305	A1	7/2012	Elam et al.	2013/0012034	A1	1/2013	Ahn et al.
2012/0190178	A1	7/2012	Wang et al.	2013/0014697	A1	1/2013	Kanayama
2012/0190185	A1	7/2012	Rogers	2013/0014896	A1	1/2013	Shoji et al.
2012/0190208	A1	7/2012	Ozu et al.	2013/0017503	A1	1/2013	De Ridder et al.
2012/0196048	A1	8/2012	Ueda	2013/0019944	A1	1/2013	Hekmatshoar-Tabai et al.
2012/0196242	A1	8/2012	Volfovski et al.	2013/0019945	A1	1/2013	Hekmatshoar-Tabai et al.
2012/0196450	A1	8/2012	Balseanu et al.	2013/0019960	A1	1/2013	Choi et al.
2012/0202358	A1	8/2012	Gealy et al.	2013/0020246	A1	1/2013	Hoots et al.
2012/0206033	A1	8/2012	Matsuyama	2013/0023120	A1	1/2013	Yaehashi et al.
2012/0207456	A1	8/2012	Kim et al.	2013/0023124	A1	1/2013	Nemani et al.
2012/0212121	A1	8/2012	Lin	2013/0023129	A1	1/2013	Reed
2012/0213947	A1	8/2012	Lee	2013/0025538	A1	1/2013	Collins et al.
2012/0214318	A1	8/2012	Fukazawa et al.	2013/0025786	A1	1/2013	Davidkovich et al.
2012/0216743	A1	8/2012	Itoh et al.	2013/0026451	A1	1/2013	Bangsaruntip et al.
2012/0219735	A1	8/2012	Bakker et al.	2013/0032085	A1	2/2013	Hanawa et al.
2012/0219824	A1	8/2012	Prolier	2013/0037532	A1	2/2013	Volfovski et al.
2012/0220139	A1	8/2012	Lee et al.	2013/0037858	A1	2/2013	Hong et al.
2012/0222813	A1	9/2012	Pal et al.	2013/0037886	A1	2/2013	Tsai et al.
2012/0222815	A1	9/2012	Sabri et al.	2013/0040447	A1	2/2013	Swaminathan et al.
2012/0225192	A1	9/2012	Yudovsky et al.	2013/0040481	A1	2/2013	Vallely et al.
2012/0225561	A1	9/2012	Watanabe	2013/0042811	A1	2/2013	Shanker et al.
2012/0231771	A1	9/2012	Marcus	2013/0048606	A1	2/2013	Mao et al.
2012/0232340	A1	9/2012	Levy et al.	2013/0052585	A1	2/2013	Ayothi et al.
2012/0238074	A1	9/2012	Santhanam et al.	2013/0052836	A1	2/2013	Hirose et al.
2012/0240858	A1	9/2012	Taniyama et al.	2013/0059078	A1	3/2013	Gatineau et al.
2012/0241089	A1	9/2012	Dielmann et al.	2013/0061755	A1	3/2013	Frederick
2012/0241411	A1	9/2012	Darling et al.	2013/0062753	A1	3/2013	Nguyen et al.
2012/0244703	A1	9/2012	Nakayama et al.	2013/0062839	A1	3/2013	Tschinderle et al.
2012/0247386	A1	10/2012	Sanchez et al.	2013/0064973	A1	3/2013	Chen et al.
2012/0252229	A1	10/2012	Timans et al.	2013/0065189	A1	3/2013	Yoshii et al.
2012/0258257	A1	10/2012	Nguyen et al.	2013/0068391	A1	3/2013	Mazzocco et al.
2012/0263876	A1	10/2012	Haukka et al.	2013/0068727	A1	3/2013	Okita
2012/0263887	A1	10/2012	Papasouliotis et al.	2013/0068970	A1	3/2013	Matsushita
2012/0264051	A1	10/2012	Angelov et al.	2013/0069052	A1	3/2013	Sandhu
2012/0264305	A1	10/2012	Nakano	2013/0070456	A1	3/2013	Jang et al.
2012/0267048	A1	10/2012	Moyama et al.	2013/0075746	A1	3/2013	Mallikarjunaswamy et al.
2012/0269967	A1	10/2012	Yudovsky et al.	2013/0078376	A1	3/2013	Higashino et al.
2012/0270339	A1	10/2012	Xie et al.	2013/0078392	A1	3/2013	Xiao et al.
2012/0270384	A1	10/2012	Sanchez et al.	2013/0081702	A1	4/2013	Mohammed et al.
2012/0270393	A1	10/2012	Pore et al.	2013/0082274	A1	4/2013	Yang
2012/0273052	A1	11/2012	Ye et al.	2013/0084156	A1	4/2013	Shimamoto
2012/0273162	A1	11/2012	Mahadeswaraswamy	2013/0084408	A1	4/2013	Nakao et al.
2012/0276306	A1	11/2012	Ueda	2013/0084711	A1	4/2013	Liang et al.
2012/0288625	A1	11/2012	Furuya et al.	2013/0084714	A1	4/2013	Oka et al.
2012/0289053	A1	11/2012	Holland et al.	2013/0085618	A1	4/2013	Ding
2012/0289056	A1	11/2012	Bergman et al.	2013/0089667	A1	4/2013	Lai et al.
2012/0289057	A1	11/2012	DeDontney	2013/0089716	A1	4/2013	Krishnamurthy et al.
2012/0295427	A1	11/2012	Bauer	2013/0089988	A1	4/2013	Wang et al.
2012/0295449	A1	11/2012	Fukazawa	2013/0092085	A1	4/2013	Lee
2012/0302055	A1	11/2012	Pore et al.	2013/0093048	A1	4/2013	Chang et al.
2012/0303313	A1	11/2012	Moroi et al.	2013/0093321	A1	4/2013	Yoshikawa et al.
2012/0304935	A1	12/2012	Oosterlaken et al.	2013/0095664	A1	4/2013	Matero et al.
				2013/0095973	A1	4/2013	Kroneberger et al.
				2013/0099318	A1	4/2013	Adam et al.
				2013/0104988	A1	5/2013	Yednak et al.
				2013/0104992	A1	5/2013	Yednak et al.

(56)

References Cited

U.S. PATENT DOCUMENTS

2013/0107415	A1	5/2013	Banna et al.	2013/0288471	A1	10/2013	Chi
2013/0109172	A1	5/2013	Collins et al.	2013/0288480	A1	10/2013	Sanchez et al.
2013/0109192	A1	5/2013	Hawkins et al.	2013/0288485	A1	10/2013	Liang et al.
2013/0112251	A1	5/2013	Hang et al.	2013/0292047	A1	11/2013	Tian et al.
2013/0113085	A1	5/2013	Michaelson et al.	2013/0292676	A1	11/2013	Milligan et al.
2013/0115383	A1	5/2013	Lu et al.	2013/0292807	A1	11/2013	Raisanen et al.
2013/0115763	A1	5/2013	Takamure et al.	2013/0295779	A1	11/2013	Chandra et al.
2013/0115768	A1	5/2013	Pore et al.	2013/0299944	A1	11/2013	Lai et al.
2013/0118405	A1	5/2013	Ho et al.	2013/0302520	A1	11/2013	Wang et al.
2013/0118895	A1	5/2013	Roozeboom et al.	2013/0302999	A1	11/2013	Won et al.
2013/0119018	A1	5/2013	Kanarik et al.	2013/0303803	A1	11/2013	Doerr et al.
2013/0122712	A1	5/2013	Kim et al.	2013/0309876	A1	11/2013	Ogawa
2013/0122722	A1	5/2013	Cissell et al.	2013/0312663	A1	11/2013	Khosla et al.
2013/0126515	A1	5/2013	Shero et al.	2013/0313656	A1	11/2013	Tong
2013/0129577	A1	5/2013	Halpin et al.	2013/0319290	A1	12/2013	Xiao et al.
2013/0130490	A1	5/2013	Lee et al.	2013/0320429	A1	12/2013	Thomas
2013/0134148	A1	5/2013	Tachikawa	2013/0323435	A1	12/2013	Xiao et al.
2013/0137279	A1	5/2013	Yamamoto et al.	2013/0323859	A1	12/2013	Chen et al.
2013/0143401	A1	6/2013	Yu et al.	2013/0323935	A1	12/2013	Suzuki et al.
2013/0143415	A1	6/2013	Yudovsky et al.	2013/0330165	A1	12/2013	Wimplinger
2013/0145587	A1	6/2013	Adhiprakasha	2013/0330911	A1	12/2013	Huang et al.
2013/0145984	A1	6/2013	Zhang et al.	2013/0330933	A1	12/2013	Fukazawa et al.
2013/0149874	A1	6/2013	Hirose et al.	2013/0333619	A1	12/2013	Omari
2013/0152933	A1	6/2013	Lischer et al.	2013/0337172	A1	12/2013	Lee
2013/0157409	A1	6/2013	Vaidya	2013/0337583	A1	12/2013	Kobayashi et al.
2013/0157521	A1	6/2013	Aldrich et al.	2013/0337639	A1	12/2013	Ivanstov et al.
2013/0160709	A1	6/2013	White et al.	2013/0337653	A1	12/2013	Kovalgin et al.
2013/0161629	A1	6/2013	Han et al.	2013/0340619	A1	12/2013	Tammera
2013/0164458	A1	6/2013	Soininen et al.	2013/0340678	A1	12/2013	Wamura et al.
2013/0168353	A1	7/2013	Okita et al.	2013/0344248	A1	12/2013	Clark
2013/0168354	A1	7/2013	Kanarik	2014/0000843	A1	1/2014	Dunn et al.
2013/0171818	A1	7/2013	Kim et al.	2014/0001520	A1	1/2014	Glass
2013/0175596	A1	7/2013	Cheng et al.	2014/0004274	A1	1/2014	Thompson
2013/0177706	A1	7/2013	Baluja et al.	2014/0007808	A1	1/2014	Okabe et al.
2013/0180448	A1	7/2013	Sakaue et al.	2014/0014642	A1	1/2014	Elliot et al.
2013/0183814	A1	7/2013	Huang et al.	2014/0014644	A1	1/2014	Akiba et al.
2013/0186340	A1	7/2013	Omori et al.	2014/0015108	A1	1/2014	Kim et al.
2013/0189635	A1	7/2013	Lim et al.	2014/0015186	A1	1/2014	Wessel et al.
2013/0189854	A1	7/2013	Hausmann et al.	2014/0017408	A1	1/2014	Gandikota et al.
2013/0196502	A1	8/2013	Haukka et al.	2014/0017414	A1	1/2014	Fukazawa et al.
2013/0196507	A1	8/2013	Ma et al.	2014/0017908	A1	1/2014	Beynet et al.
2013/0200518	A1	8/2013	Ahmed et al.	2014/0020619	A1	1/2014	Vincent et al.
2013/0202387	A1	8/2013	Hiroki	2014/0020764	A1	1/2014	Woelk et al.
2013/0203266	A1	8/2013	Hintze	2014/0020839	A1	1/2014	Kenney et al.
2013/0203267	A1	8/2013	Pomarede et al.	2014/0023794	A1	1/2014	Mahajani et al.
2013/0206066	A1	8/2013	Han et al.	2014/0027884	A1	1/2014	Tang et al.
2013/0209940	A1	8/2013	Sakamoto et al.	2014/0030447	A1	1/2014	Lee
2013/0210241	A1	8/2013	Lavoie et al.	2014/0033978	A1	2/2014	Adachi et al.
2013/0213300	A1	8/2013	Sung et al.	2014/0034240	A1	2/2014	Kim et al.
2013/0214232	A1	8/2013	Tendulkar et al.	2014/0034632	A1	2/2014	Pan et al.
2013/0217239	A1	8/2013	Mallick et al.	2014/0036274	A1	2/2014	Marquardt et al.
2013/0217240	A1	8/2013	Mallick et al.	2014/0045324	A1	2/2014	Brabant et al.
2013/0217241	A1	8/2013	Underwood et al.	2014/0045342	A1	2/2014	Mallick et al.
2013/0217243	A1	8/2013	Underwood et al.	2014/0047705	A1	2/2014	Singh
2013/0219853	A1	8/2013	Little et al.	2014/0048765	A1	2/2014	Ma et al.
2013/0224964	A1	8/2013	Fukazawa	2014/0053866	A1	2/2014	Baluja et al.
2013/0228225	A1	9/2013	Leeser	2014/0056679	A1	2/2014	Yamabe et al.
2013/0228902	A1	9/2013	Tomizawa et al.	2014/0056770	A1	2/2014	Bedard et al.
2013/0230814	A1	9/2013	Dunn et al.	2014/0057187	A1	2/2014	Suzuki et al.
2013/0234203	A1	9/2013	Tsai et al.	2014/0057454	A1	2/2014	Subramonium
2013/0242287	A1	9/2013	Schlezinger	2014/0058179	A1	2/2014	Stevens et al.
2013/0256265	A1	10/2013	Darling et al.	2014/0060147	A1	3/2014	Sarin et al.
2013/0256838	A1	10/2013	Sanchez et al.	2014/0060572	A1	3/2014	Yasumuro et al.
2013/0256962	A1	10/2013	Ranish	2014/0061770	A1	3/2014	Lee
2013/0260371	A1	10/2013	Holt	2014/0062304	A1	3/2014	Nakano et al.
2013/0264659	A1	10/2013	Jung	2014/0065841	A1	3/2014	Matero
2013/0267045	A1	10/2013	Lee et al.	2014/0067110	A1	3/2014	Lawson et al.
2013/0269609	A1	10/2013	Leeser	2014/0072710	A1	3/2014	Valle
2013/0269612	A1	10/2013	Cheng et al.	2014/0072726	A1	3/2014	Kim
2013/0270676	A1	10/2013	Lindert et al.	2014/0072925	A1	3/2014	Kaneko
2013/0276978	A1	10/2013	Bluck et al.	2014/0073082	A1	3/2014	Song
2013/0280891	A1	10/2013	Kim et al.	2014/0073143	A1	3/2014	Alokozai et al.
2013/0285155	A1	10/2013	Glass	2014/0076861	A1	3/2014	Cornelius et al.
2013/0287526	A1	10/2013	Bluck et al.	2014/0077240	A1	3/2014	Roucka et al.
2013/0288427	A1	10/2013	Hung et al.	2014/0080314	A1	3/2014	Sasajima et al.
				2014/0084341	A1	3/2014	Weeks
				2014/0087490	A1	3/2014	Kahlon
				2014/0087544	A1	3/2014	Tolle
				2014/0087564	A1	3/2014	Shimizu et al.

(56)

References Cited

U.S. PATENT DOCUMENTS

2014/0094027	A1	4/2014	Azumo et al.	2014/0262034	A1	9/2014	Ishibashi et al.
2014/0096716	A1	4/2014	Chung et al.	2014/0262193	A1	9/2014	Im et al.
2014/0097468	A1	4/2014	Okita	2014/0263172	A1	9/2014	Xie et al.
2014/0099794	A1	4/2014	Ingle et al.	2014/0263272	A1	9/2014	Duan et al.
2014/0099798	A1	4/2014	Tsuji	2014/0264297	A1	9/2014	Kumar et al.
2014/0103145	A1	4/2014	White et al.	2014/0264444	A1	9/2014	Guo et al.
2014/0106574	A1	4/2014	Kang et al.	2014/0264902	A1	9/2014	Ting et al.
2014/0110798	A1	4/2014	Cai	2014/0265090	A1	9/2014	Hou
2014/0113457	A1	4/2014	Sims	2014/0265832	A1	9/2014	Kenney et al.
2014/0116335	A1	5/2014	Tsuji et al.	2014/0272194	A1	9/2014	Xiao et al.
2014/0117380	A1	5/2014	Loboda et al.	2014/0272341	A1	9/2014	Duan et al.
2014/0120487	A1	5/2014	Kaneko	2014/0273428	A1	9/2014	Shero
2014/0120678	A1	5/2014	Shinriki et al.	2014/0273477	A1	9/2014	Niskanen
2014/0120723	A1	5/2014	Fu et al.	2014/0273497	A1	9/2014	Payne et al.
2014/0120738	A1	5/2014	Jung	2014/0273510	A1	9/2014	Chen et al.
2014/0120750	A1	5/2014	Johnson	2014/0273528	A1	9/2014	Niskanen
2014/0127907	A1	5/2014	Yang	2014/0273530	A1	9/2014	Nguyen
2014/0130687	A1	5/2014	Shibusawa et al.	2014/0273531	A1	9/2014	Niskanen
2014/0138779	A1	5/2014	Xie et al.	2014/0283747	A1	9/2014	Kasai et al.
2014/0141165	A1	5/2014	Sato et al.	2014/0287164	A1	9/2014	Xiao et al.
2014/0141625	A1	5/2014	Fukazawa et al.	2014/0287595	A1	9/2014	Shimamoto et al.
2014/0141674	A1	5/2014	Galbreath et al.	2014/0290573	A1	10/2014	Okabe et al.
2014/0144375	A1	5/2014	Kim et al.	2014/0290578	A1	10/2014	Wamura et al.
2014/0144500	A1	5/2014	Cao et al.	2014/0306250	A1	10/2014	Gardner et al.
2014/0145332	A1	5/2014	Ryan et al.	2014/0308108	A1	10/2014	Fosnight et al.
2014/0147587	A1	5/2014	Endo et al.	2014/0312767	A1	10/2014	Tian et al.
2014/0148924	A1	5/2014	Brak et al.	2014/0322862	A1	10/2014	Xie et al.
2014/0158786	A1	6/2014	Santo	2014/0322885	A1	10/2014	Xie et al.
2014/0159170	A1	6/2014	Raisanen et al.	2014/0339981	A1	11/2014	Komatsu et al.
2014/0162401	A1	6/2014	Kawano et al.	2014/0346142	A1	11/2014	Chapuis et al.
2014/0167187	A1	6/2014	Kuo et al.	2014/0346650	A1	11/2014	Raisanen et al.
2014/0170335	A1	6/2014	Shao et al.	2014/0349033	A1	11/2014	Nonaka et al.
2014/0174354	A1	6/2014	Arai	2014/0349068	A1	11/2014	Inglis et al.
2014/0174357	A1	6/2014	Kim et al.	2014/0357090	A1	12/2014	Knaepen et al.
2014/0174927	A1	6/2014	Bashir et al.	2014/0360430	A1	12/2014	Armour et al.
2014/0175054	A1	6/2014	Carlson et al.	2014/0363980	A1	12/2014	Kawamata et al.
2014/0179091	A1	6/2014	Clark	2014/0363983	A1	12/2014	Nakano et al.
2014/0179092	A1	6/2014	Kim	2014/0363985	A1	12/2014	Jang et al.
2014/0182053	A1	7/2014	Huang	2014/0366804	A1	12/2014	Pak et al.
2014/0182689	A1	7/2014	Shareef et al.	2014/0367043	A1	12/2014	Bishara et al.
2014/0187022	A1	7/2014	Falster et al.	2014/0367642	A1	12/2014	Guo
2014/0187045	A1	7/2014	Hua et al.	2014/0377960	A1	12/2014	Koiwa
2014/0190581	A1	7/2014	Nagase et al.	2015/0004316	A1	1/2015	Thompson et al.
2014/0191389	A1	7/2014	Lee et al.	2015/0004317	A1	1/2015	Dussarrat et al.
2014/0193983	A1	7/2014	Lavoie	2015/0004318	A1	1/2015	Alasaarela et al.
2014/0202382	A1	7/2014	Kim et al.	2015/0004798	A1	1/2015	Chandrasekharan et al.
2014/0202386	A1	7/2014	Taga	2015/0007770	A1	1/2015	Chandrasekharan et al.
2014/0202388	A1	7/2014	Um et al.	2015/0010381	A1	1/2015	Cai
2014/0209976	A1	7/2014	Yang et al.	2015/0011095	A1	1/2015	Chandrasekharan et al.
2014/0213061	A1	7/2014	Huang et al.	2015/0014632	A1	1/2015	Kim et al.
2014/0217065	A1	8/2014	Winkler et al.	2015/0014823	A1	1/2015	Mallikarjunan et al.
2014/0220247	A1	8/2014	Haukka et al.	2015/0017794	A1	1/2015	Takamure
2014/0225065	A1	8/2014	Rachmady et al.	2015/0021599	A1	1/2015	Ridgeway
2014/0227072	A1	8/2014	Lee et al.	2015/0024609	A1	1/2015	Milligan et al.
2014/0227444	A1	8/2014	Winter et al.	2015/0030766	A1	1/2015	Lind et al.
2014/0227861	A1	8/2014	Wu et al.	2015/0030782	A1	1/2015	Ivanov et al.
2014/0227881	A1	8/2014	Lubomirsky et al.	2015/0031218	A1	1/2015	Karakawa
2014/0231922	A1	8/2014	Kim et al.	2015/0041431	A1	2/2015	Zafiropoulo et al.
2014/0234466	A1	8/2014	Gao et al.	2015/0048485	A1	2/2015	Tolle
2014/0234550	A1	8/2014	Winter et al.	2015/0056815	A1	2/2015	Fernandez
2014/0234992	A1	8/2014	Kubota et al.	2015/0056821	A1	2/2015	Ishikawa et al.
2014/0238607	A1	8/2014	Nozawa et al.	2015/0064923	A1	3/2015	Matsumoto et al.
2014/0238608	A1	8/2014	Sabri et al.	2015/0072509	A1	3/2015	Chi et al.
2014/0242298	A1	8/2014	Lansalot-Matras et al.	2015/0078874	A1	3/2015	Sansoni
2014/0242806	A1	8/2014	Knapp et al.	2015/0079311	A1	3/2015	Nakano
2014/0242808	A1	8/2014	Akiyama et al.	2015/0086316	A1	3/2015	Greenberg
2014/0245948	A1	9/2014	Nguyen et al.	2015/0086716	A1	3/2015	Park et al.
2014/0251788	A1	9/2014	Ge et al.	2015/0087139	A1	3/2015	O'Neill et al.
2014/0251953	A1	9/2014	Winkler et al.	2015/0087154	A1	3/2015	Guha et al.
2014/0251954	A1	9/2014	Winkler et al.	2015/0091057	A1	4/2015	Xie et al.
2014/0252134	A1	9/2014	Chen	2015/0091134	A1	4/2015	Amaratunga et al.
2014/0252479	A1	9/2014	Utomo et al.	2015/0094470	A1	4/2015	Sanchez et al.
2014/0252710	A1	9/2014	Cuvalci et al.	2015/0096973	A1	4/2015	Dunn et al.
2014/0260684	A1	9/2014	Christmann	2015/0099065	A1	4/2015	Canizares et al.
2014/0262028	A1	9/2014	Kelekar	2015/0099072	A1	4/2015	Takamure et al.
				2015/0099123	A1	4/2015	Barbee et al.
				2015/0099342	A1	4/2015	Tsai
				2015/0099374	A1	4/2015	Kakimoto et al.
				2015/0099375	A1	4/2015	Haripin et al.

(56)

References Cited

U.S. PATENT DOCUMENTS

2015/0102466	A1	4/2015	Colinge	2015/0243563	A1	8/2015	Lee et al.
2015/0104574	A1	4/2015	Lee et al.	2015/0243658	A1	8/2015	Joshi et al.
2015/0110147	A1	4/2015	Mizuno	2015/0247259	A1	9/2015	Hekmatshoar-Tabari et al.
2015/0111374	A1	4/2015	Bao	2015/0249013	A1	9/2015	Arghavani et al.
2015/0111395	A1	4/2015	Hashimoto et al.	2015/0255319	A1	9/2015	Kikuchi et al.
2015/0114295	A1	4/2015	Kim et al.	2015/0255324	A1	9/2015	Li et al.
2015/0118009	A1	4/2015	Hsieh et al.	2015/0255385	A1	9/2015	Lee et al.
2015/0118846	A1	4/2015	Isii et al.	2015/0259790	A1	9/2015	Newman
2015/0118863	A1	4/2015	Rathod et al.	2015/0259801	A1	9/2015	Matsumoto et al.
2015/0122180	A1	5/2015	Chang et al.	2015/0262828	A1	9/2015	Brand et al.
2015/0125628	A1	5/2015	Kim et al.	2015/0263033	A1	9/2015	Aoyama
2015/0132212	A1	5/2015	Winkler et al.	2015/0267294	A1	9/2015	Itatani
2015/0140210	A1	5/2015	Jung et al.	2015/0267295	A1	9/2015	Hill et al.
2015/0144060	A1	5/2015	Park	2015/0267297	A1	9/2015	Shiba
2015/0147482	A1	5/2015	Kang et al.	2015/0267298	A1	9/2015	Saitou et al.
2015/0147483	A1	5/2015	Fukazawa	2015/0267299	A1	9/2015	Hawkins et al.
2015/0147488	A1	5/2015	Choi et al.	2015/0267301	A1	9/2015	Hill et al.
2015/0147875	A1	5/2015	Takamure et al.	2015/0270140	A1	9/2015	Gupta et al.
2015/0147877	A1	5/2015	Jung	2015/0270146	A1	9/2015	Yoshihara et al.
2015/0152547	A1	6/2015	Nakamura et al.	2015/0275355	A1	10/2015	Mallikarjunan et al.
2015/0152553	A1	6/2015	Popp et al.	2015/0275357	A1	10/2015	Kamakura et al.
2015/0155177	A1	6/2015	Zhang et al.	2015/0279665	A1	10/2015	Zafiropoulo
2015/0155370	A1	6/2015	Tsai et al.	2015/0279681	A1	10/2015	Knoops
2015/0162168	A1	6/2015	Oehrlie	2015/0279682	A1	10/2015	Nakatani et al.
2015/0162185	A1	6/2015	Pore	2015/0279708	A1	10/2015	Kobayashi et al.
2015/0162214	A1	6/2015	Thompson	2015/0279956	A1	10/2015	Ozaki et al.
2015/0167159	A1	6/2015	Halpin et al.	2015/0280051	A1	10/2015	Xu
2015/0167161	A1	6/2015	Canizares et al.	2015/0284848	A1	10/2015	Nakano et al.
2015/0167162	A1	6/2015	Barik et al.	2015/0287591	A1	10/2015	Pore et al.
2015/0167165	A1	6/2015	Lindfors	2015/0287612	A1	10/2015	Luere et al.
2015/0167705	A1	6/2015	Lee et al.	2015/0287626	A1	10/2015	Arai
2015/0170907	A1	6/2015	Haukka et al.	2015/0287710	A1	10/2015	Yun et al.
2015/0170914	A1	6/2015	Haukka et al.	2015/0291830	A1	10/2015	Galbreath et al.
2015/0170945	A1	6/2015	Segawa et al.	2015/0292088	A1	10/2015	Canizares
2015/0170947	A1	6/2015	Bluck	2015/0299848	A1	10/2015	Haukka et al.
2015/0170954	A1	6/2015	Agarwal	2015/0307982	A1	10/2015	Firouzdor et al.
2015/0170975	A1	6/2015	Blatchford et al.	2015/0307989	A1	10/2015	Lindfors
2015/0171177	A1	6/2015	Cheng et al.	2015/0308586	A1	10/2015	Shugrue et al.
2015/0174768	A1	6/2015	Rodnick	2015/0311151	A1	10/2015	Chi et al.
2015/0175467	A1	6/2015	Denifl et al.	2015/0303056	A1	11/2015	Varadarajan et al.
2015/0176126	A1	6/2015	Ge et al.	2015/0315704	A1	11/2015	Nakano et al.
2015/0179415	A1	6/2015	Sasaki et al.	2015/0322569	A1	11/2015	Kilpi et al.
2015/0179501	A1	6/2015	Jhaveri et al.	2015/0325432	A1	11/2015	Ishizaka
2015/0179564	A1	6/2015	Lee et al.	2015/0332921	A1	11/2015	Lee et al.
2015/0179640	A1	6/2015	Kim et al.	2015/0340247	A1	11/2015	Balakrishnan et al.
2015/0184287	A1	7/2015	Tsung et al.	2015/0340266	A1	11/2015	Ngo et al.
2015/0184291	A1	7/2015	Alokozai et al.	2015/0340500	A1	11/2015	Brunco
2015/0187559	A1	7/2015	Sano	2015/0340609	A1	11/2015	Banno et al.
2015/0187568	A1	7/2015	Pettinger et al.	2015/0343559	A1	12/2015	Morikazu et al.
2015/0187611	A1	7/2015	Sato	2015/0343741	A1	12/2015	Shibata et al.
2015/0187908	A1	7/2015	Zhang et al.	2015/0345018	A1	12/2015	Detavernier et al.
2015/0203961	A1	7/2015	Ha et al.	2015/0345022	A1	12/2015	Yudovsky et al.
2015/0203967	A1	7/2015	Dhas et al.	2015/0348755	A1	12/2015	Han et al.
2015/0211124	A1	7/2015	Nozawa et al.	2015/0349073	A1	12/2015	Kang
2015/0211125	A1	7/2015	Yoshikawa et al.	2015/0353478	A1	12/2015	Hoshino et al.
2015/0217330	A1	8/2015	Haukka	2015/0354060	A1	12/2015	Yabe et al.
2015/0217456	A1	8/2015	Tsuji et al.	2015/0361550	A1	12/2015	Yabe et al.
2015/0218695	A1	8/2015	Odedra	2015/0361553	A1	12/2015	Murakawa
2015/0218698	A1	8/2015	Yoon et al.	2015/0364347	A1	12/2015	Nguyen et al.
2015/0218700	A1	8/2015	Nguyen et al.	2015/0364371	A1	12/2015	Yen
2015/0221479	A1	8/2015	Chen et al.	2015/0364747	A1	12/2015	Elam et al.
2015/0221480	A1	8/2015	Duan et al.	2015/0367253	A1	12/2015	Kanyal et al.
2015/0221519	A1	8/2015	Marks et al.	2015/0368798	A1	12/2015	Kwong
2015/0225850	A1	8/2015	Arora et al.	2015/0371864	A1	12/2015	Hsu et al.
2015/0228513	A1	8/2015	Parkhe et al.	2015/0372056	A1	12/2015	Seong et al.
2015/0228572	A1	8/2015	Yang et al.	2015/0376211	A1	12/2015	Girard
2015/0228645	A1	8/2015	Chuang et al.	2015/0376785	A1	12/2015	Knaapen et al.
2015/0228749	A1	8/2015	Ando et al.	2015/0380296	A1	12/2015	Antonelli et al.
2015/0240357	A1	8/2015	Tachibana et al.	2016/0002776	A1	1/2016	Nai et al.
2015/0240359	A1	8/2015	Jdira et al.	2016/0002786	A1	1/2016	Gatineau et al.
2015/0240360	A1	8/2015	Leeser	2016/0005571	A1	1/2016	Della Rosa et al.
2015/0241787	A1	8/2015	Yaegashi	2016/0005595	A1	1/2016	Liu et al.
2015/0243522	A1	8/2015	Kitagaito et al.	2016/0005839	A1	1/2016	Yieh et al.
2015/0243542	A1	8/2015	Yoshihara et al.	2016/0010208	A1	1/2016	Huang et al.
2015/0243545	A1	8/2015	Tang	2016/0013022	A1	1/2016	Ayoub
				2016/0013024	A1	1/2016	Milligan et al.
				2016/0013086	A1	1/2016	Yang et al.
				2016/0017493	A1	1/2016	Dhas
				2016/0020071	A1	1/2016	Khaja et al.

(56)

References Cited

U.S. PATENT DOCUMENTS

2016/0020092	A1	1/2016	Kang et al.	2016/0268102	A1	9/2016	White
2016/0024655	A1	1/2016	Yudovsky et al.	2016/0268107	A1	9/2016	White
2016/0024656	A1	1/2016	White et al.	2016/0273101	A1	9/2016	Komori et al.
2016/0032453	A1	2/2016	Qian et al.	2016/0273106	A1	9/2016	Kanjolia et al.
2016/0035566	A1	2/2016	LaVoie	2016/0273128	A1	9/2016	Kang
2016/0035596	A1	2/2016	Kamiya	2016/0276148	A1	9/2016	Qian et al.
2016/0042954	A1	2/2016	Sung et al.	2016/0276212	A1	9/2016	Horikoshi
2016/0051964	A1	2/2016	Tolle et al.	2016/0279629	A1	9/2016	Michishita et al.
2016/0056074	A1	2/2016	Na	2016/0281223	A1	9/2016	Sowa et al.
2016/0056156	A1	2/2016	Ghani et al.	2016/0281230	A1	9/2016	Varadarajan et al.
2016/0060752	A1	3/2016	Jacques et al.	2016/0284517	A1	9/2016	Saido
2016/0064208	A1	3/2016	Zafiropoulo et al.	2016/0284542	A1	9/2016	Noda et al.
2016/0064231	A1	3/2016	Agarwal et al.	2016/0289828	A1	10/2016	Shero et al.
2016/0069613	A1	3/2016	Colgan et al.	2016/0293398	A1	10/2016	Danek et al.
2016/0071750	A1	3/2016	de Ridder et al.	2016/0305015	A1	10/2016	Nakamura et al.
2016/0076949	A1	3/2016	Sabah et al.	2016/0307739	A1	10/2016	Lee et al.
2016/0079054	A1	3/2016	Chen et al.	2016/0307740	A1	10/2016	Kim et al.
2016/0085003	A1	3/2016	Jaiswal	2016/0307766	A1	10/2016	Jongbloed et al.
2016/0086811	A1	3/2016	Mackedanz et al.	2016/0312360	A1	10/2016	Rasheed et al.
2016/0087028	A1	3/2016	Hirota et al.	2016/0314962	A1	10/2016	Higashino et al.
2016/0097123	A1	4/2016	Shugrue et al.	2016/0314964	A1	10/2016	Tang et al.
2016/0099150	A1	4/2016	Tsai	2016/0314967	A1	10/2016	Tolle
2016/0099166	A1	4/2016	Yudovsky	2016/0315168	A1	10/2016	Dussarrat et al.
2016/0099250	A1	4/2016	Rabkin et al.	2016/0334709	A1	11/2016	Huli et al.
2016/0102214	A1	4/2016	Dietz et al.	2016/0336178	A1	11/2016	Swaminathan et al.
2016/0111272	A1	4/2016	Girard	2016/0336392	A1	11/2016	Tominaga et al.
2016/0111304	A1	4/2016	Takahashi et al.	2016/0345384	A1	11/2016	Zhang et al.
2016/0111438	A1	4/2016	Tsutsumi et al.	2016/0351413	A1	12/2016	Schmidt et al.
2016/0115590	A1	4/2016	Haukka et al.	2016/0351747	A1	12/2016	Forrest et al.
2016/0118224	A1	4/2016	Kohno et al.	2016/0358772	A1	12/2016	Xie
2016/0133307	A1	5/2016	Lee et al.	2016/0362783	A1	12/2016	Tolle et al.
2016/0133504	A1	5/2016	Chu et al.	2016/0362813	A1	12/2016	Bao et al.
2016/0133628	A1	5/2016	Xie	2016/0365280	A1	12/2016	Brink et al.
2016/0141172	A1	5/2016	Kang	2016/0365414	A1	12/2016	Peng et al.
2016/0145738	A1	5/2016	Liu et al.	2016/0372321	A1	12/2016	Krishnan et al.
2016/0148800	A1	5/2016	Henri et al.	2016/0372365	A1	12/2016	Tang et al.
2016/0148801	A1	5/2016	Yabe et al.	2016/0372744	A1	12/2016	Essaki et al.
2016/0148806	A1	5/2016	Henri et al.	2016/0376700	A1	12/2016	Haukka
2016/0148811	A1	5/2016	Nakatani et al.	2016/0376704	A1	12/2016	Raisanen
2016/0148821	A1	5/2016	Singh	2016/0379826	A9	12/2016	Arghavani et al.
2016/0153088	A1	6/2016	Tsuji et al.	2016/0379851	A1	12/2016	Swaminathan et al.
2016/0155629	A1	6/2016	Hawryluk et al.	2016/0381732	A1	12/2016	Moench et al.
2016/0163556	A1	6/2016	Briggs et al.	2017/0009347	A1	1/2017	Jang et al.
2016/0163558	A1	6/2016	Hudson et al.	2017/0009367	A1	1/2017	Harris et al.
2016/0163561	A1	6/2016	Hudson et al.	2017/0011889	A1	1/2017	Winkler et al.
2016/0163711	A1	6/2016	Arndt et al.	2017/0011926	A1	1/2017	Harada et al.
2016/0163972	A1	6/2016	Swaminathan et al.	2017/0011950	A1	1/2017	Schmotzer
2016/0168699	A1	6/2016	Fukazawa et al.	2017/0018477	A1	1/2017	Kato
2016/0169766	A1	6/2016	Ishibashi et al.	2017/0018570	A1	1/2017	Lue et al.
2016/0172189	A1	6/2016	Tapily	2017/0025280	A1	1/2017	Milligan
2016/0172296	A1	6/2016	Lim et al.	2017/0025291	A1	1/2017	Lin
2016/0175805	A1	6/2016	Catchpole et al.	2017/0029945	A1	2/2017	Kamakura
2016/0177448	A1	6/2016	Ikeda	2017/0032942	A1	2/2017	Walfried
2016/0181117	A1	6/2016	Arghavani et al.	2017/0032943	A1	2/2017	Spaulding et al.
2016/0181128	A1	6/2016	Mori	2017/0032992	A1	2/2017	Hoechbauer
2016/0181368	A1	6/2016	Weeks	2017/0033004	A1	2/2017	Siew et al.
2016/0190137	A1	6/2016	Tsai et al.	2017/0037513	A1	2/2017	Haukka
2016/0195331	A1	7/2016	Hyon et al.	2017/0040164	A1	2/2017	Wang et al.
2016/0196969	A1	7/2016	Berry et al.	2017/0040206	A1	2/2017	Schmotzer et al.
2016/0196970	A1	7/2016	Takamure et al.	2017/0044664	A1	2/2017	Dussarrat et al.
2016/0203995	A1	7/2016	Kanarik et al.	2017/0044665	A1	2/2017	Shon et al.
2016/0204005	A1	7/2016	Okii et al.	2017/0044666	A1	2/2017	Jang et al.
2016/0204436	A1	7/2016	Barker et al.	2017/0047446	A1	2/2017	Margetis et al.
2016/0211135	A1	7/2016	Noda et al.	2017/0051402	A1	2/2017	Mori
2016/0211147	A1	7/2016	Fukazawa	2017/0051405	A1	2/2017	Fukazawa et al.
2016/0211166	A1	7/2016	Yan et al.	2017/0051406	A1	2/2017	Mori et al.
2016/0217857	A1	7/2016	Paudel	2017/0051408	A1	2/2017	Kosuke et al.
2016/0218028	A1	7/2016	Schaller et al.	2017/0053811	A1	2/2017	Fung et al.
2016/0222504	A1	8/2016	Haukka et al.	2017/0058402	A1	3/2017	Wenxu et al.
2016/0222509	A1	8/2016	Honma	2017/0062204	A1	3/2017	Suzuki et al.
2016/0222516	A1	8/2016	Ikeda et al.	2017/0062209	A1	3/2017	Shiba
2016/0225607	A1	8/2016	Yamamoto et al.	2017/0062210	A1	3/2017	Visser et al.
2016/0225632	A1	8/2016	Shaikh et al.	2017/0062218	A1	3/2017	Duan et al.
2016/0245704	A1	8/2016	Osaka et al.	2017/0062224	A1	3/2017	Fu et al.
2016/0256187	A1	9/2016	Shelton et al.	2017/0062258	A1	3/2017	Bluck
				2017/0069725	A1	3/2017	Bhimarasetti et al.
				2017/0091320	A1	3/2017	Psota et al.
				2017/0092469	A1	3/2017	Kurita et al.
				2017/0092531	A1	3/2017	Coomer

(56)

References Cited

U.S. PATENT DOCUMENTS

2017/0092535	A1	3/2017	Kimihiko et al.	2017/0306478	A1	10/2017	Raisanen et al.
2017/0092847	A1	3/2017	Kim et al.	2017/0306479	A1	10/2017	Raisanen et al.
2017/0100742	A1	4/2017	Pore et al.	2017/0306480	A1	10/2017	Zhu et al.
2017/0103907	A1	4/2017	Chu et al.	2017/0309490	A1	10/2017	Ogawa
2017/0104061	A1	4/2017	Peng et al.	2017/0309528	A1	10/2017	Bansal et al.
2017/0107621	A1	4/2017	Suemori	2017/0316933	A1	11/2017	Xie et al.
2017/0110313	A1	4/2017	Tang et al.	2017/0316940	A1	11/2017	Ishikawa et al.
2017/0110601	A1	4/2017	Blomberg et al.	2017/0317194	A1	11/2017	Tang et al.
2017/0114460	A1	4/2017	Kim et al.	2017/0323783	A1	11/2017	Sanchez et al.
2017/0114464	A1	4/2017	Iriuda et al.	2017/0323784	A1	11/2017	Faguet et al.
2017/0114465	A1	4/2017	Kalutarage et al.	2017/0338111	A1	11/2017	Takamure et al.
2017/0117141	A1	4/2017	Zhu et al.	2017/0338133	A1	11/2017	Tan et al.
2017/0117202	A1	4/2017	Tang et al.	2017/0338134	A1	11/2017	Tan et al.
2017/0117203	A1	4/2017	Tang et al.	2017/0338192	A1	11/2017	Lee et al.
2017/0117222	A1	4/2017	Kim et al.	2017/0342559	A1	11/2017	Fukazawa et al.
2017/0121845	A1	5/2017	Grutzmacher et al.	2017/0343896	A1	11/2017	Darling et al.
2017/0130332	A1	5/2017	Stumpf	2017/0345674	A1	11/2017	Ranjan et al.
2017/0136578	A1	5/2017	Yoshimura	2017/0350688	A1	12/2017	Boyd et al.
2017/0140925	A1	5/2017	Suzuki et al.	2017/0358445	A1	12/2017	O'Shaughnessy et al.
2017/0145564	A1	5/2017	Bertuch et al.	2017/0358482	A1	12/2017	Chen et al.
2017/0146909	A1	5/2017	Smith et al.	2017/0358670	A1	12/2017	Kub et al.
2017/0148918	A1	5/2017	Ye et al.	2017/0362710	A1	12/2017	Ge et al.
2017/0152968	A1	6/2017	Raj et al.	2017/0365467	A1	12/2017	Shimamoto et al.
2017/0154757	A1	6/2017	Winkler et al.	2017/0372884	A1	12/2017	Margetis et al.
2017/0154770	A1	6/2017	Margetis et al.	2017/0372919	A1	12/2017	Manna et al.
2017/0154895	A1	6/2017	Huo	2017/0373188	A1	12/2017	Mochizuki et al.
2017/0159177	A1	6/2017	Monsma et al.	2018/0005814	A1	1/2018	Kumar et al.
2017/0165624	A1	6/2017	Ravooin et al.	2018/0010243	A1	1/2018	Lee et al.
2017/0167023	A1	6/2017	Proia et al.	2018/0010247	A1	1/2018	Niskanen
2017/0170033	A1	6/2017	Okabe et al.	2018/0011052	A1	1/2018	Andersson et al.
2017/0173696	A1	6/2017	Sheinman	2018/0012792	A1	1/2018	Zhu
2017/0175290	A1	6/2017	Chen et al.	2018/0019165	A1	1/2018	Baum et al.
2017/0178899	A1	6/2017	Kabansky et al.	2018/0025890	A1	1/2018	Choi
2017/0178939	A1	6/2017	Omori	2018/0025907	A1	1/2018	Kalutarage et al.
2017/0178942	A1	6/2017	Sakata et al.	2018/0025939	A1	1/2018	Kovalgin et al.
2017/0179036	A1	6/2017	Chen et al.	2018/0033614	A1	2/2018	Chandra et al.
2017/0186621	A1	6/2017	Zaitso	2018/0033616	A1	2/2018	Masaru
2017/0186754	A1	6/2017	Blomberg et al.	2018/0033625	A1	2/2018	Yoo
2017/0191159	A1	7/2017	Polyak et al.	2018/0033645	A1	2/2018	Saido et al.
2017/0191164	A1	7/2017	Alokozai et al.	2018/0033674	A1	2/2018	Jeong
2017/0191685	A1	7/2017	Ronne et al.	2018/0033679	A1	2/2018	Pore
2017/0191861	A1	7/2017	Rondano et al.	2018/0040746	A1	2/2018	Johnson et al.
2017/0196562	A1	7/2017	Shelton	2018/0044800	A1	2/2018	Hendrix et al.
2017/0200622	A1	7/2017	Shiokawa et al.	2018/0047591	A1	2/2018	Ogo
2017/0204516	A1	7/2017	Nguyen et al.	2018/0047749	A1	2/2018	Kim
2017/0216762	A1	8/2017	Shugrue et al.	2018/0053660	A1	2/2018	Jandl et al.
2017/0218515	A1	8/2017	Shin et al.	2018/0053769	A1	2/2018	Kim et al.
2017/0222008	A1	8/2017	Hsu et al.	2018/0057931	A1	3/2018	Cha et al.
2017/0226636	A1	8/2017	Xiao	2018/0057934	A1	3/2018	Cooper et al.
2017/0232457	A1	8/2017	Toshiki et al.	2018/0057937	A1	3/2018	Lee et al.
2017/0233868	A1	8/2017	Donoso et al.	2018/0061628	A1	3/2018	Ou et al.
2017/0243734	A1	8/2017	Ishikawa et al.	2018/0061851	A1	3/2018	Ootsuka
2017/0250068	A1	8/2017	Ishikawa et al.	2018/0068844	A1	3/2018	Chen et al.
2017/0250075	A1	8/2017	Caymax et al.	2018/0068862	A1	3/2018	Terakura et al.
2017/0253968	A1	9/2017	Yahata	2018/0068950	A1	3/2018	Bruley et al.
2017/0256393	A1	9/2017	Kim et al.	2018/0069019	A1	3/2018	Kim et al.
2017/0256417	A1	9/2017	Chou	2018/0076021	A1	3/2018	Fukushima et al.
2017/0256429	A1	9/2017	Lawson et al.	2018/0083435	A1	3/2018	Redler
2017/0260649	A1	9/2017	Coomer	2018/0087152	A1	3/2018	Yoshida
2017/0263437	A1	9/2017	Li et al.	2018/0087154	A1	3/2018	Pore et al.
2017/0267527	A1	9/2017	Kim et al.	2018/0087156	A1	3/2018	Kohei et al.
2017/0267531	A1	9/2017	Huakka	2018/0090583	A1	3/2018	Choi et al.
2017/0271191	A1	9/2017	Yoo et al.	2018/0094351	A1	4/2018	Verghese et al.
2017/0271256	A1	9/2017	Inatsuka	2018/0096821	A1*	4/2018	Lubomirsky H01J 37/32532
2017/0271501	A1	9/2017	Avci et al.	2018/0096844	A1	4/2018	Dutartre et al.
2017/0278705	A1	9/2017	Murakami et al.	2018/0097076	A1	4/2018	Cheng et al.
2017/0278707	A1	9/2017	Margetis et al.	2018/0102276	A1	4/2018	Zhu et al.
2017/0287681	A1	10/2017	Nitadori et al.	2018/0105930	A1	4/2018	Kang et al.
2017/0287744	A1	10/2017	Kobayashi et al.	2018/0108587	A1	4/2018	Jiang
2017/0294318	A1	10/2017	Yoshida et al.	2018/0114680	A1	4/2018	Kim et al.
2017/0294339	A1	10/2017	Tapily	2018/0119283	A1	5/2018	Fukazawa
2017/0294499	A1	10/2017	Lu et al.	2018/0122642	A1	5/2018	Raisanen
2017/0301519	A1	10/2017	Naim et al.	2018/0122709	A1	5/2018	Xie
2017/0301542	A1	10/2017	Maes et al.	2018/0122959	A1	5/2018	Calka et al.
2017/0303382	A1	10/2017	Smith et al.	2018/0126379	A1	5/2018	Ramsey et al.
				2018/0127876	A1	5/2018	Tolle
				2018/0130652	A1	5/2018	Pettinger et al.
				2018/0130701	A1	5/2018	Chun
				2018/0135172	A1	5/2018	Nogami et al.

(56)

References Cited

U.S. PATENT DOCUMENTS

2018/0135173	A1	5/2018	Kim et al.	2019/0006797	A1	1/2019	Paynter et al.
2018/0135179	A1	5/2018	Toshiyuki et al.	2019/0013199	A1	1/2019	Bhargava et al.
2018/0138036	A1	5/2018	Baldesseroni et al.	2019/0019670	A1	1/2019	Lin et al.
2018/0142353	A1	5/2018	Tetsuya et al.	2019/0027573	A1	1/2019	Zhu et al.
2018/0142357	A1	5/2018	Yoshikazu	2019/0027583	A1	1/2019	Margetis et al.
2018/0148832	A1	5/2018	Chatterjee et al.	2019/0027584	A1	1/2019	Margetis et al.
2018/0151346	A1	5/2018	Blanquart	2019/0027605	A1	1/2019	Tolle et al.
2018/0151358	A1	5/2018	Margetis et al.	2019/0032209	A1	1/2019	Huggare
2018/0151588	A1	5/2018	Tsutsumi et al.	2019/0032998	A1	1/2019	Jdira et al.
2018/0155832	A1	6/2018	Hamalainen et al.	2019/0035605	A1	1/2019	Suzuki
2018/0155836	A1	6/2018	Arai et al.	2019/0035647	A1	1/2019	Lee et al.
2018/0158688	A1	6/2018	Chen	2019/0035810	A1	1/2019	Chun et al.
2018/0158716	A1	6/2018	Konkola et al.	2019/0040529	A1	2/2019	Verbaas et al.
2018/0163305	A1	6/2018	Batzer et al.	2019/0046947	A1	2/2019	Strohm et al.
2018/0166258	A1	6/2018	Kim et al.	2019/0051544	A1	2/2019	Verbaas
2018/0166315	A1	6/2018	Coomer	2019/0051548	A1	2/2019	den Hartog Besselink et al.
2018/0171475	A1	6/2018	Maes et al.	2019/0051555	A1	2/2019	Hill et al.
2018/0171477	A1	6/2018	Kim et al.	2019/0057857	A1	2/2019	Ishikawa et al.
2018/0172172	A1	6/2018	Oehler et al.	2019/0057858	A1	2/2019	Hausmann et al.
2018/0173109	A1	6/2018	Gronheid et al.	2019/0058043	A1	2/2019	Dewey et al.
2018/0174801	A1	6/2018	Chen et al.	2019/0062907	A1	2/2019	Kim et al.
2018/0174826	A1	6/2018	Raaijmakers et al.	2019/0062917	A1	2/2019	Sung et al.
2018/0179625	A1	6/2018	Takagi et al.	2019/0066978	A1	2/2019	Um et al.
2018/0180509	A1	6/2018	Sawachi et al.	2019/0066997	A1	2/2019	Klaver et al.
2018/0182613	A1	6/2018	Blanquart et al.	2019/0067003	A1	2/2019	Zope et al.
2018/0182618	A1	6/2018	Blanquart et al.	2019/0067004	A1	2/2019	Kohen et al.
2018/0187303	A1	7/2018	Gatineau et al.	2019/0067014	A1	2/2019	Shrestha et al.
2018/0189923	A1	7/2018	Zhong et al.	2019/0067016	A1	2/2019	Zhu et al.
2018/0190496	A1	7/2018	Ashihara et al.	2019/0067085	A1	2/2019	Kweskin
2018/0195174	A1	7/2018	Kim et al.	2019/0067094	A1	2/2019	Zope et al.
2018/0204733	A1	7/2018	Sherpa et al.	2019/0067095	A1	2/2019	Zhu et al.
2018/0211834	A1	7/2018	Takamure et al.	2019/0080903	A1	3/2019	Abel et al.
2018/0223047	A1	8/2018	Xiao et al.	2019/0081072	A1	3/2019	Chun et al.
2018/0223429	A1	8/2018	Fukazawa et al.	2019/0085451	A1	3/2019	Lei et al.
2018/0230595	A1	8/2018	Suda et al.	2019/0086807	A1	3/2019	Kachel et al.
2018/0233372	A1	8/2018	Vayrynen et al.	2019/0088555	A1	3/2019	Xie et al.
2018/0245215	A1	8/2018	Lei et al.	2019/0089143	A1	3/2019	Malone et al.
2018/0246101	A1	8/2018	Sasisekharan et al.	2019/0093221	A1	3/2019	Jdira et al.
2018/0254211	A1	9/2018	Kosakai et al.	2019/0096708	A1	3/2019	Sharma
2018/0258532	A1	9/2018	Kato et al.	2019/0106788	A1	4/2019	Hawkins et al.
2018/0265294	A1	9/2018	Hayashi	2019/0109002	A1	4/2019	Mattinen et al.
2018/0269057	A1	9/2018	Lei et al.	2019/0109009	A1	4/2019	Longrie et al.
2018/0277338	A1	9/2018	Fukada et al.	2019/0112711	A1	4/2019	Lyons et al.
2018/0277423	A1	9/2018	Lottes	2019/0115206	A1	4/2019	Kim et al.
2018/0286638	A1	10/2018	Susa	2019/0115237	A1	4/2019	den Hartog Besselink et al.
2018/0286663	A1	10/2018	Kobayashi et al.	2019/0115451	A1	4/2019	Lee et al.
2018/0286668	A1	10/2018	Baum et al.	2019/0131124	A1	5/2019	Kohen et al.
2018/0286672	A1	10/2018	Van Aerde et al.	2019/0140067	A1	5/2019	Zhu et al.
2018/0286675	A1	10/2018	Blomberg et al.	2019/0148177	A1	5/2019	Yin et al.
2018/0286711	A1	10/2018	Oosterlaken et al.	2019/0148224	A1	5/2019	Kuroda et al.
2018/0294187	A1	10/2018	Thombare et al.	2019/0148398	A1	5/2019	Kim et al.
2018/0305247	A1	10/2018	Feng et al.	2019/0153593	A1	5/2019	Zhu et al.
2018/0308686	A1	10/2018	Xie et al.	2019/0157054	A1	5/2019	White et al.
2018/0308701	A1	10/2018	Na et al.	2019/0157067	A1	5/2019	Bhuyan et al.
2018/0312966	A1	11/2018	Chan et al.	2019/0163056	A1	5/2019	Maes et al.
2018/0315838	A1	11/2018	Morrow et al.	2019/0164763	A1	5/2019	Raisanen et al.
2018/0323055	A1	11/2018	Woodruff et al.	2019/0176435	A1	6/2019	Bellman et al.
2018/0323056	A1	11/2018	Woodruff et al.	2019/0181002	A1	6/2019	Iijima et al.
2018/0323059	A1	11/2018	Bhargava et al.	2019/0185999	A1	6/2019	Shanbhag et al.
2018/0325414	A1	11/2018	Marashdeh et al.	2019/0189447	A1	6/2019	Kamp et al.
2018/0331117	A1	11/2018	Titus et al.	2019/0198359	A1	6/2019	Kamimura et al.
2018/0337087	A1	11/2018	Sandhu et al.	2019/0198571	A1	6/2019	Xu et al.
2018/0350587	A1	12/2018	Jia et al.	2019/0204029	A1	7/2019	Tanabe
2018/0350588	A1	12/2018	Raisanen et al.	2019/0211450	A1*	7/2019	Adachi C23C 16/458
2018/0350620	A1	12/2018	Zaitso et al.	2019/0217277	A1	7/2019	Jeon et al.
2018/0350653	A1	12/2018	Jeong et al.	2019/0221433	A1	7/2019	Raisanen
2018/0355480	A1	12/2018	Kondo	2019/0229008	A1	7/2019	Rokkam et al.
2018/0355484	A1	12/2018	Lansalot-Matras et al.	2019/0233940	A1	8/2019	Guo et al.
2018/0358222	A1	12/2018	Venkatasubramanian et al.	2019/0237325	A1	8/2019	Wang et al.
2018/0363131	A1	12/2018	Lee et al.	2019/0237327	A1	8/2019	Kohen et al.
2018/0363139	A1	12/2018	Rajavelu et al.	2019/0244803	A1	8/2019	Suzuki
2018/0366314	A1	12/2018	Niskanen et al.	2019/0249300	A1	8/2019	Hatanpaa et al.
2018/0371610	A1	12/2018	Banerjee et al.	2019/0249303	A1	8/2019	Kuroda et al.
2019/0003050	A1	1/2019	Dezelah et al.	2019/0252195	A1	8/2019	Haukka
2019/0003052	A1	1/2019	Shero et al.	2019/0252196	A1	8/2019	Vayrynen et al.
				2019/0259611	A1	8/2019	Nakano et al.
				2019/0259612	A1	8/2019	Nozawa et al.
				2019/0264324	A1	8/2019	Shugrue et al.
				2019/0271078	A1	9/2019	Raisanen et al.

(56)

References Cited

U.S. PATENT DOCUMENTS

2019/0272981	A1	9/2019	Xu et al.	2020/0135512	A1	4/2020	Oosterlaken et al.
2019/0272993	A1	9/2019	Mattinen et al.	2020/0140995	A1	5/2020	Blanquart et al.
2019/0273133	A1	9/2019	Agrawal et al.	2020/0141003	A1	5/2020	Lee et al.
2019/0276934	A1	9/2019	Vergheze et al.	2020/0144058	A1	5/2020	Kohen
2019/0287769	A1	9/2019	Blomberg et al.	2020/0152473	A1	5/2020	Tapily et al.
2019/0295837	A1	9/2019	Pore et al.	2020/0152750	A1	5/2020	Morrow et al.
2019/0301014	A1	10/2019	Pierreux et al.	2020/0161129	A1	5/2020	Mattinen et al.
2019/0304776	A1	10/2019	Choi	2020/0161438	A1	5/2020	Tang et al.
2019/0304780	A1	10/2019	Kohen et al.	2020/0168485	A1	5/2020	Fluit
2019/0304790	A1	10/2019	Mousa et al.	2020/0279758	A1	5/2020	Sharma
2019/0304821	A1	10/2019	Pierreux et al.	2020/0173020	A1	6/2020	Huggare
2019/0311894	A1	10/2019	Girard et al.	2020/0176244	A1	6/2020	Lee et al.
2019/0311897	A1	10/2019	Kang et al.	2020/0176246	A1	6/2020	Huotari et al.
2019/0311940	A1	10/2019	Choi et al.	2020/0181770	A1	6/2020	Longrie et al.
2019/0318923	A1	10/2019	Blanquart et al.	2020/0185257	A1	6/2020	Nishiwaki
2019/0319100	A1	10/2019	Chen et al.	2020/0194253	A1	6/2020	Banerjee et al.
2019/0322812	A1	10/2019	Wojtecki et al.	2020/0194268	A1	6/2020	Sharma
2019/0330740	A1	10/2019	Klaver	2020/0224309	A1	7/2020	Sreeram et al.
2019/0333753	A1	10/2019	Ueda et al.	2020/0224311	A1	7/2020	Niskanen et al.
2019/0333761	A1	10/2019	Tois et al.	2020/0227243	A1	7/2020	Kim et al.
2019/0338418	A1	11/2019	Goradia et al.	2020/0227250	A1	7/2020	Pore et al.
2019/0346300	A1	11/2019	Kim et al.	2020/0227325	A1	7/2020	Xie et al.
2019/0348261	A1	11/2019	Lin et al.	2020/0232096	A1	7/2020	Hatanpää et al.
2019/0348273	A1	11/2019	Tang et al.	2020/0234989	A1	7/2020	Jeong
2019/0348515	A1	11/2019	Li et al.	2020/0251328	A1	8/2020	Zaitsu et al.
2019/0362970	A1	11/2019	Wang et al.	2020/0258766	A1	8/2020	Garssen et al.
2019/0362989	A1	11/2019	Reuter et al.	2020/0266057	A1	8/2020	Lee et al.
2019/0363006	A1	11/2019	Min	2020/0266097	A1	8/2020	Liu et al.
2019/0363015	A1	11/2019	Cheng et al.	2020/0266098	A1	8/2020	Pore et al.
2019/0368040	A1	12/2019	Kachel et al.	2020/0266208	A1	8/2020	Kim et al.
2019/0368041	A1	12/2019	Sreeram et al.	2020/0270749	A1	8/2020	Li et al.
2019/0371594	A1	12/2019	Niskanen et al.	2020/0270752	A1	8/2020	Pierreux et al.
2019/0371640	A1	12/2019	Raisanen et al.	2020/0273729	A1	8/2020	Verbaas et al.
2019/0375638	A1	12/2019	Haukka	2020/0279721	A1	9/2020	White et al.
2019/0376180	A1	12/2019	Niskanen	2020/0283893	A1	9/2020	Byun et al.
2019/0378916	A1	12/2019	Tang et al.	2020/0283894	A1	9/2020	Lehn et al.
2019/0385907	A1	12/2019	Gottheim et al.	2020/0284467	A1	9/2020	Lindeboom et al.
2019/0390338	A1	12/2019	Raisanen et al.	2020/0286725	A1	9/2020	Sharma et al.
2019/0390343	A1	12/2019	Min et al.	2020/0286726	A1	9/2020	Shero et al.
2019/0393304	A1	12/2019	Guillorn et al.	2020/0294789	A1	9/2020	Woodruff et al.
2019/0393308	A1	12/2019	Lo et al.	2020/0303180	A1	9/2020	Kim et al.
2020/0002811	A1	1/2020	Sreeram et al.	2020/0303196	A1	9/2020	Chen et al.
2020/0002812	A1	1/2020	Lee et al.	2020/0309455	A1	10/2020	Fluit
2020/0013612	A1	1/2020	Blanquart et al.	2020/0312652	A1	10/2020	Kang et al.
2020/0013613	A1	1/2020	Blanquart	2020/0312681	A1	10/2020	Tanaka et al.
2020/0013626	A1	1/2020	Longrie et al.	2020/0318237	A1	10/2020	Fukazawa
2020/0013629	A1	1/2020	de Roest et al.	2020/0321209	A1	10/2020	Ishikawa et al.
2020/0018421	A1	1/2020	Shugrue	2020/0332416	A1	10/2020	Fluit
2020/0035489	A1	1/2020	Huang et al.	2020/0340113	A1	10/2020	Hatanpää et al.
2020/0040458	A1	2/2020	Ma et al.	2020/0340138	A1	10/2020	Tolle et al.
2020/0048768	A1	2/2020	Wiegers et al.	2020/0343134	A1	10/2020	Kovalgin et al.
2020/0052056	A1	2/2020	Park et al.	2020/0343358	A1	10/2020	Zhu et al.
2020/0056282	A1	2/2020	Raisanen et al.	2020/0350193	A1	11/2020	Garssen
2020/0056286	A1	2/2020	Shero et al.	2020/0354836	A1	11/2020	Yednak et al.
2020/0063262	A1	2/2020	Katou et al.	2020/0355296	A1	11/2020	Shugrue et al.
2020/0064737	A1	2/2020	de Roest	2020/0357631	A1	11/2020	Ueda
2020/0066552	A1	2/2020	Susa	2020/0365391	A1	11/2020	Blanquart et al.
2020/0080200	A1	3/2020	Um et al.	2020/0365433	A1	11/2020	de Ridder et al.
2020/0083054	A1	3/2020	Väyrynen et al.	2020/0365434	A1	11/2020	de Ridder
2020/0083375	A1	3/2020	Tolle et al.	2020/0365444	A1	11/2020	Hill et al.
2020/0083469	A1	3/2020	Lhullier	2020/0373152	A1	11/2020	Blanquart
2020/0102649	A1	4/2020	Reed	2020/0385861	A1	12/2020	Deye et al.
2020/0102653	A1	4/2020	Muralidhar et al.	2020/0385867	A1	12/2020	Kim et al.
2020/0105579	A1	4/2020	Zhu	2020/0385868	A1	12/2020	Kim et al.
2020/0105594	A1	4/2020	Cheng et al.	2020/0395199	A1	12/2020	Miyama
2020/0109472	A1	4/2020	Um et al.	2020/0395209	A1	12/2020	Yoshimoto et al.
2020/0111669	A1	4/2020	Zaitsu et al.	2020/0395444	A1	12/2020	Lo et al.
2020/0111690	A1	4/2020	Oosterlaken	2021/0002762	A1	1/2021	Jun et al.
2020/0118811	A1	4/2020	Utsuno et al.	2021/0005449	A1	1/2021	Blanquart et al.
2020/0118815	A1	4/2020	Fukazawa et al.	2021/0005450	A1	1/2021	Mattinen et al.
2020/0118817	A1	4/2020	Blomberg et al.	2021/0005723	A1	1/2021	Tang et al.
2020/0119038	A1	4/2020	Hopkins et al.	2021/0013010	A1	1/2021	Yoshikawa et al.
2020/0126771	A1	4/2020	Roh et al.	2021/0013037	A1	1/2021	Sun et al.
2020/0126840	A1	4/2020	Roh et al.	2021/0013042	A1	1/2021	Väyrynen et al.
2020/0131634	A1	4/2020	Gao et al.	2021/0013085	A1	1/2021	Roh et al.
				2021/0020429	A1	1/2021	Khazaka et al.
				2021/0020431	A1	1/2021	Blanquart et al.
				2021/0020432	A1	1/2021	Blanquart
				2021/0020467	A1	1/2021	Sekiguchi

(56)

References Cited

U.S. PATENT DOCUMENTS

2021/0020470 A1 1/2021 Lee
 2021/0028021 A1 1/2021 Mousa et al.
 2021/0017648 A1 2/2021 Kubota et al.
 2021/0032754 A1 2/2021 White et al.
 2021/0033977 A1 2/2021 Raaijmakers et al.
 2021/0035785 A1 2/2021 Jeong et al.
 2021/0035786 A1 2/2021 Jeong et al.
 2021/0035802 A1 2/2021 Tolle et al.
 2021/0035824 A1 2/2021 de Ridder
 2021/0035839 A1 2/2021 de Ridder
 2021/0035840 A1 2/2021 de Ridder et al.
 2021/0035841 A1 2/2021 Fluit
 2021/0035842 A1 2/2021 de Ridder
 2021/0035854 A1 2/2021 Yoo et al.
 2021/0040613 A1 2/2021 White et al.
 2021/0040615 A1 2/2021 White et al.
 2021/0043444 A1 2/2021 Blanquart
 2021/0050231 A1 2/2021 Oosterlaken
 2021/0054500 A1 2/2021 Zope et al.
 2021/0054504 A1 2/2021 Wang et al.
 2021/0057214 A1 2/2021 Kengoyama et al.
 2021/0057223 A1 2/2021 Stevens et al.
 2021/0057275 A1 2/2021 Pierreux et al.
 2021/0057570 A1 2/2021 Lin et al.
 2021/0066075 A1 3/2021 Zhang et al.
 2021/0066079 A1 3/2021 Lima et al.
 2021/0066080 A1 3/2021 Mattinen et al.
 2021/0066083 A1 3/2021 Haukka
 2021/0066084 A1 3/2021 Raisanen et al.
 2021/0071296 A1 3/2021 Watarai et al.
 2021/0071298 A1 3/2021 Maes et al.
 2021/0074527 A1 3/2021 Lee et al.
 2021/0082692 A1 3/2021 Kikuchi
 2021/0090878 A1 3/2021 Kang et al.
 2021/0095372 A1 4/2021 Minjauw et al.
 2021/0102289 A1 4/2021 Tsuji et al.
 2021/0102290 A1 4/2021 Acosta et al.
 2021/0102292 A1 4/2021 Lin et al.
 2021/0104399 A1 4/2021 Kuroda et al.
 2021/0111025 A1 4/2021 Zyulkov et al.
 2021/0111053 A1 4/2021 De Ridder
 2021/0118667 A1 4/2021 Fukazawa et al.
 2021/0118679 A1 4/2021 Lima et al.
 2021/0118687 A1 4/2021 Wang et al.
 2021/0125827 A1 4/2021 Khazaka et al.
 2021/0125832 A1 4/2021 Bhatnagar
 2021/0134588 A1 5/2021 Kohen et al.
 2021/0134959 A1 5/2021 Lima et al.
 2021/0143003 A1 5/2021 Fukuda et al.
 2021/0151315 A1 5/2021 Pierreux et al.
 2021/0151348 A1 5/2021 Utsuno et al.
 2021/0151352 A1 5/2021 Zope et al.
 2021/0156024 A1 5/2021 Roh et al.
 2021/0156030 A1 5/2021 Shugrue
 2021/0159077 A1 5/2021 Longrie et al.
 2021/0166910 A1 6/2021 Kim et al.
 2021/0166924 A1 6/2021 Moon et al.
 2021/0166925 A1 6/2021 Moon et al.
 2021/0041284 A1 11/2021 Yednak

FOREIGN PATENT DOCUMENTS

CN 2588350 11/2003
 CN 1563483 1/2005
 CN 1655362 8/2005
 CN 1664987 9/2005
 CN 1825535 8/2006
 CN 101142012 3/2008
 CN 101609858 12/2009
 CN 101681873 3/2010
 CN 102383106 3/2012
 CN 103014846 4/2013
 CN 102539019 9/2013
 CN 103515222 1/2014
 CN 102373440 7/2014

CN 203721699 7/2014
 CN 104244620 12/2014
 CN 105253917 1/2016
 CN 104342637 2/2017
 CN 104233226 6/2017
 CN 104201108 11/2017
 CN 104630735 12/2017
 CN 108389798 8/2018
 CN 106011785 10/2018
 DE 8902307 8/1989
 DE 3836696 12/1989
 DE 3626724 6/1994
 DE 10133013 1/2003
 DE 102008052750 6/2009
 EP 0058571 8/1982
 EP 0499004 8/1992
 EP 0634785 1/1995
 EP 0550058 11/1998
 EP 0887632 12/1998
 EP 678909 7/1999
 EP 1061567 12/2000
 EP 1889817 2/2008
 EP 2036600 3/2009
 EP 2426233 7/2012
 FR 686869 7/1930
 FR 1408266 8/1965
 FR 2233614 1/1975
 FR 2517790 6/1983
 FR 2610007 8/1990
 GB 752-277 7/1956
 GB 1186889 6/1966
 GB 1514921 6/1978
 GB 2051875 1/1981
 JP 58-19462 4/1983
 JP S5979545 5/1984
 JP S59127847 7/1984
 JP 59-211779 11/1984
 JP S60110133 6/1985
 JP 61038863 2/1986
 JP S62237236 10/1987
 JP S63136532 6/1988
 JP H01185176 7/1989
 JP H01-296613 11/1989
 JP H01307229 12/1989
 JP H01313954 12/1989
 JP H02-93071 4/1990
 JP H02-185038 7/1990
 JP H02-217469 8/1990
 JP H03-044472 2/1991
 JP H03-155625 7/1991
 JP H03211753 9/1991
 JP H03-248427 11/1991
 JP H04-29313 1/1992
 JP H04-115531 4/1992
 JP H05-6880 1/1993
 JP H05-23079 3/1993
 JP 405118928 5/1993
 JP H05-118928 5/1993
 JP H05-171446 7/1993
 JP H05-291142 11/1993
 JP H06-053210 2/1994
 JP H06-84888 3/1994
 JP H06-140399 5/1994
 JP H0616433 6/1994
 JP 6204231 7/1994
 JP H06-319177 11/1994
 JP H06-338497 12/1994
 JP H07-297271 1/1995
 JP H0729836 1/1995
 JP 07066267 3/1995
 JP H07-74162 3/1995
 JP H07-109576 4/1995
 JP 07034936 8/1995
 JP H07-034936 8/1995
 JP H07-225214 8/1995
 JP 7-272694 10/1995
 JP H07-283149 10/1995
 JP H07-209093 11/1995
 JP H08-181135 7/1996

(56)

References Cited

FOREIGN PATENT DOCUMENTS					
			JP	2009194248	8/2009
			JP	2009239082	10/2009
			JP	2009251216	10/2009
			JP	2009252851	10/2009
			JP	2010067940	3/2010
			JP	2010097834	4/2010
			JP	2010205967	9/2010
			JP	2010251444	10/2010
			JP	2010255218	11/2010
			JP	2011049592	3/2011
			JP	2011162830	8/2011
			JP	2011181681	9/2011
			JP	2009010412	2/2012
			JP	2012146939	8/2012
			JP	2012164736	8/2012
			JP	2012195513	10/2012
			JP	2013026479	2/2013
			JP	2013196822	9/2013
			JP	2013235912	11/2013
			JP	D1422467	8/2014
			JP	2014222693	11/2014
			JP	2015021175	2/2015
			JP	2015115461	6/2015
			JP	2016098406	5/2016
			JP	2010123843	6/2016
			JP	2016174158	9/2016
			JP	2017183242	10/2017
			JP	6519897	5/2019
			KR	1998-0026850	7/1998
			KR	20000000946	1/2000
			KR	10-0253664	4/2000
			KR	10-2000-0031098	6/2000
			KR	10-2000-0045257	7/2000
			KR	100273261	12/2000
			KR	10-0295043	4/2001
			KR	10-2002-0027695	4/2002
			KR	10-2002-0064028	8/2002
			KR	2002-0086763	11/2002
			KR	10-0377095	3/2003
			KR	2003-0092305	12/2003
			KR	10-2005-0054122	6/2005
			KR	10-0547248	1/2006
			KR	10-0593960	6/2006
			KR	10-2006-0129566	12/2006
			KR	10-0688484	2/2007
			KR	10-2007-0079797	8/2007
			KR	10-2007-0084683	8/2007
			KR	20080058620	6/2008
			KR	10-2009-0039936	4/2009
			KR	10-2009-0055443	6/2009
			KR	10-2009-0056475	6/2009
			KR	10-2009-0086790	8/2009
			KR	10-2009-0105977	10/2009
			KR	10-0936694	1/2010
			KR	10-2010-0015073	2/2010
			KR	10-2010-0020834	2/2010
			KR	10-2010-0032812	3/2010
			KR	10-2010-0077442	7/2010
			KR	10-2010-0079920	7/2010
			KR	10-2010-0122701	11/2010
			KR	10-2010-0132779	12/2010
			KR	10-2011-0058534	6/2011
			KR	10-1114219	3/2012
			KR	20120111060	10/2012
			KR	10-2013-0007806	1/2013
			KR	10-2013-0067600	6/2013
			KR	10-2013-0129149	11/2013
			KR	10-1347962	1/2014
			KR	101491726	2/2015
			KR	10-1535573	7/2015
			KR	10-2019-0032077	3/2019
			NL	8600255	9/1987
			NL	8701549	2/1989
			RU	1786406	1/1993
			SU	494614	2/1976
			SU	1408319	7/1988
			TW	538327	6/2003
			TW	540093	7/2003
			TW	M292692	6/2006
JP	H08-335558	12/1996			
JP	H09-064149	3/1997			
JP	9-89676	4/1997			
JP	H09-148322	6/1997			
JP	H10-41096	2/1998			
JP	H10-50635	2/1998			
JP	H1050800	2/1998			
JP	H10-064696	3/1998			
JP	H10-153494	6/1998			
JP	H10-227703	8/1998			
JP	H10-0261620	9/1998			
JP	H11-097163	4/1999			
JP	H11-118615	4/1999			
JP	H11-183264	7/1999			
JP	H11-183265	7/1999			
JP	H11-195688	7/1999			
JP	H11-287715	10/1999			
JP	2000068355	3/2000			
JP	2000182949	6/2000			
JP	2000269163	9/2000			
JP	2001015698	1/2001			
JP	2001023872	1/2001			
JP	2001207265	7/2001			
JP	2001207268	7/2001			
JP	2001210602	8/2001			
JP	2001220677	8/2001			
JP	2001257199	9/2001			
JP	2001287180	10/2001			
JP	2002164342	6/2002			
JP	2002170781	6/2002			
JP	2002237375	8/2002			
JP	2003035574	2/2003			
JP	2003053688	2/2003			
JP	2003133300	5/2003			
JP	2003153706	5/2003			
JP	2003303814	10/2003			
JP	2004014952	1/2004			
JP	2004023043	1/2004			
JP	2004091848	3/2004			
JP	2004113270	4/2004			
JP	2004128019	4/2004			
JP	2004134553	4/2004			
JP	2004163293	6/2004			
JP	2004244661	9/2004			
JP	2004294638	10/2004			
JP	3589954	11/2004			
JP	2004310019	11/2004			
JP	2005033221	2/2005			
JP	2005079254	3/2005			
JP	2005507030	3/2005			
JP	2005172489	6/2005			
JP	3725100	12/2005			
JP	2006028572	2/2006			
JP	2006049352	2/2006			
JP	2006059931	3/2006			
JP	2006090762	4/2006			
JP	2006124832	5/2006			
JP	2006153706	6/2006			
JP	2006186271	7/2006			
JP	2006188729	7/2006			
JP	2006278058	10/2006			
JP	2006319261	11/2006			
JP	2007027777	2/2007			
JP	2007287902	11/2007			
JP	3140111	3/2008			
JP	2008060304	3/2008			
JP	2008066159	3/2008			
JP	2008085129	4/2008			
JP	2008089320	4/2008			
JP	2008172083	7/2008			
JP	2008198629	8/2008			
JP	2008202107	9/2008			
JP	2009016815	1/2009			
JP	2009088421	4/2009			
JP	2009099938	5/2009			

(56)

References Cited

FOREIGN PATENT DOCUMENTS

TW	200731357	8/2007
TW	200903625	1/2009
TW	201213596	4/2012
TW	201234453	8/2012
TW	201247690	12/2012
TW	M446412	2/2013
TW	201330086	7/2013
TW	D162593	8/2014
TW	D164568	12/2014
TW	201531587	8/2015
TW	M512254	11/2015
TW	I514509	12/2015
TW	201613231	4/2016
TW	M553518	12/2017
TW	D196097	2/2019
WO	1987001508	3/1987
WO	1990004045	4/1990
WO	1991004522	4/1991
WO	1991006975	5/1991
WO	1992000477	1/1992
WO	1994027315	11/1994
WO	1996017107	6/1996
WO	1997003223	1/1997
WO	1998032893	7/1998
WO	1999023690	5/1999
WO	DM/048579	7/1999
WO	2004008491	7/2002
WO	2004008827	1/2004
WO	2004010467	1/2004
WO	2004106584	12/2004
WO	2005112082	11/2005
WO	2006035281	4/2006
WO	2006054854	5/2006
WO	2006056091	6/2006
WO	2006078666	7/2006
WO	2006080782	8/2006
WO	2006097525	9/2006
WO	2006101857	9/2006
WO	2006114781	11/2006
WO	2007024720	3/2007
WO	2007027165	3/2007
WO	2007076195	7/2007
WO	2007117718	10/2007
WO	2007131051	11/2007
WO	2007140376	12/2007
WO	2008045972	4/2008
WO	2008091900	7/2008
WO	2008121463	10/2008
WO	2008147731	12/2008
WO	2009028619	3/2009
WO	2009029532	3/2009
WO	2009039251	3/2009
WO	2009099776	8/2009
WO	2009154889	12/2009
WO	2009154896	12/2009
WO	2010039363	4/2010
WO	2010077533	7/2010
WO	2010100702	9/2010
WO	2010110558	9/2010
WO	2010118051	10/2010
WO	2010129428	11/2010
WO	2010129430	11/2010
WO	2010129431	11/2010
WO	2011019950	2/2011
WO	2011149640	12/2011
WO	2012056592	5/2012
WO	2012077590	6/2012
WO	2013043330	3/2013
WO	2013078065	5/2013
WO	2013078066	5/2013
WO	2013177269	11/2013
WO	2014107290	7/2014
WO	2015026230	2/2015
WO	2015107009	7/2015
WO	2015112728	7/2015

WO	2018109553	6/2016
WO	2018109554	6/2016
WO	2017108713	6/2017
WO	2017108714	6/2017
WO	2017212546	12/2017
WO	2018003072	1/2018
WO	2018008088	1/2018
WO	2018013778	1/2018
WO	2018020316	2/2018
WO	2018020318	2/2018
WO	2018020320	2/2018
WO	2018020327	2/2018
WO	2018105349	6/2018
WO	2018109551	6/2018
WO	2018109552	6/2018
WO	2018178771	10/2018
WO	2019030565	2/2019
WO	2019103610	5/2019
WO	2019103613	5/2019
WO	2019142055	7/2019
WO	2019158960	8/2019
WO	2019217749	11/2019
WO	2019229537	12/2019
WO	2020002995	1/2020
WO	2020003000	1/2020

OTHER PUBLICATIONS

CNIPA; Office Action dated Nov. 4, 2019 in Application No. 201610898822.5.

CNIPA; Office Action dated Nov. 11, 2019 in Application No. 201810379112.0.

EPO; Extended European Search Report dated Nov. 29, 2019 in Application No. 19188826.2.

JPO; Notice of Allowance dated Nov. 20, 2019 in Application No. JP2015034774.

JPO; Notice of Allowance dated Dec. 17, 2019 in Application No. 2016001928.

KIPO; Office Action dated Nov. 29, 2019 in Application No. 10-2013-0088450.

KIPO; Notice of Allowance dated Jan. 13, 2020 in Application No. 10-2013-0088450.

KIPO; Notice of Allowance dated Oct. 30, 2019 in Application No. 10-2013-0084459.

KIPO; Office Action dated Dec. 4, 2019 in Application No. 10-2013-0098575.

KIPO; Office Action dated Feb. 3, 2020 in Application No. 10-2014-0021615.

KIPO; Office Action dated Feb. 15, 2020 in Application No. 10-2014-0027305.

TIPO; Notice of Allowance dated Jan. 7, 2020 in Application No. 102136496.

TIPO; Notice of Allowance dated Nov. 27, 2019 in Application No. 104141679.

TIPO; Office Action dated Dec. 13, 2019 in Application No. 105101536.

TIPO; Office Action dated Dec. 13, 2019 in Application No. 105111990.

TIPO; Notice of Allowance dated Dec. 10, 2019 in Application No. 105112363.

TIPO; Notice of Allowance dated Feb. 10, 2020 in Application No. 105115513.

TIPO; Notice of Allowance dated Feb. 13, 2020 in Application No. 105122715.

TIPO; Office Action dated Jan. 20, 2020 in Application No. 105122394.

TIPO; Notice of Allowance dated Jan. 16, 2020 in Application No. 107116804.

TIPO; Office Action dated Nov. 13, 2019 in Application No. 108115406.

USPTO; Notice of Allowance dated Feb. 10, 2020 in U.S. Appl. No. 13/651,144.

USPTO; Notice of Allowance dated Feb. 10, 2020 in U.S. Appl. No. 14/188,760.

(56)

References Cited

OTHER PUBLICATIONS

- USPTO; Final Office Action dated Jan. 27, 2020 in U.S. Appl. No. 14/219,839.
- USPTO; Final Office Action dated Jan. 13, 2020 in U.S. Appl. No. 14/219,879.
- USPTO; Final Office Action dated Dec. 26, 2019 in U.S. Appl. No. 15/060,412.
- USPTO; Advisory Action dated Jan. 3, 2020 in U.S. Appl. No. 15/135,258.
- USPTO; Non-Final Office Action dated Feb. 13, 2020 in U.S. Appl. No. 15/135,258.
- USPTO; Notice of Allowance dated Dec. 3, 2019 in U.S. Appl. No. 15/205,827.
- USPTO; Final Office Action dated Nov. 19, 2019 in U.S. Appl. No. 15/262,990.
- USPTO; Advisory Action dated Jan. 30, 2020 in U.S. Appl. No. 15/262,990.
- USPTO; Final Office Action dated Jan. 6, 2020 in U.S. Appl. No. 15/286,503.
- USPTO; Final Office Action dated Dec. 12, 2019 in U.S. Appl. No. 15/380,909.
- USPTO; Non-Final Office Action dated Jan. 15, 2020 in U.S. Appl. No. 15/380,921.
- USPTO; Final Office Action dated Jan. 8, 2020 in U.S. Appl. No. 15/589,849.
- USPTO; Non-Final Office Action dated Jan. 13, 2020 in U.S. Appl. No. 15/589,861.
- USPTO; Advisory Action dated Jan. 17, 2020 in U.S. Appl. No. 15/636,307.
- USPTO; Notice of Allowance dated Feb. 7, 2020 in U.S. Appl. No. 15/672,119.
- USPTO; Final Office Action dated Jan. 24, 2020 in U.S. Appl. No. 15/691,241.
- USPTO; Notice of Allowance dated Jan. 29, 2020 in U.S. Appl. No. 15/719,208.
- USPTO; Final Office Action dated Jan. 7, 2020 in U.S. Appl. No. 15/726,959.
- USPTO; Notice of Allowance dated Jan. 6, 2020 in U.S. Appl. No. 15/727,432.
- USPTO; Non-Final Office Action dated Jun. 14, 2019 in U.S. Appl. No. 15/796,593.
- USPTO; Notice of Allowance dated Dec. 31, 2019 in U.S. Appl. No. 15/796,593.
- USPTO; Final Office Action dated Jan. 13, 2020 in U.S. Appl. No. 15/815,483.
- USPTO; Advisory Action dated Jan. 21, 2020 in U.S. Appl. No. 15/860,564.
- USPTO; Notice of Allowance dated Jan. 16, 2020 in U.S. Appl. No. 15/879,209.
- USPTO; Advisory Action dated Feb. 7, 2020 in U.S. Appl. No. 15/896,986.
- USPTO; Notice of Allowance dated Dec. 17, 2019 in U.S. Appl. No. 15/900,425.
- USPTO; Advisory Action dated Nov. 27, 2019 in U.S. Appl. No. 15/917,224.
- USPTO; Non-Final Office Action dated Dec. 23, 2019 in U.S. Appl. No. 15/923,834.
- USPTO; Final Office Action dated Nov. 27, 2019 in U.S. Appl. No. 15/925,532.
- USPTO; Non-Final Rejection dated Nov. 29, 2019 in U.S. Appl. No. 15/949,990.
- USPTO; Non-Final Office Action dated Jan. 31, 2020 in U.S. Appl. No. 15/962,980.
- USPTO; Non-Final Office Action dated Jan. 16, 2020 in U.S. Appl. No. 15/985,261.
- USPTO; Final Office Action dated Jan. 13, 2020 in U.S. Appl. No. 16/000,125.
- USPTO; Non-Final Office Action dated Jan. 16, 2020 in U.S. Appl. No. 16/014,981.
- USPTO; Non-Final Office Action dated Dec. 11, 2019 in U.S. Appl. No. 16/018,692.
- USPTO; Notice of Allowance dated Jan. 30, 2020 in U.S. Appl. No. 16/018,692.
- USPTO; Notice of Allowance dated Nov. 26, 2019 in U.S. Appl. No. 16/024,390.
- USPTO; Final Office Action dated Nov. 29, 2019 in U.S. Appl. No. 16/038,024.
- USPTO; Final Office Action dated Jan. 28, 2020 in U.S. Appl. No. 16/039,867.
- USPTO; Non-Final Office Action dated Feb. 6, 2020 in U.S. Appl. No. 16/117,530.
- USPTO; Non-Final Office Action dated Jan. 6, 2020 in U.S. Appl. No. 16/132,142.
- USPTO; Notice of Allowance dated Jan. 3, 2020 in U.S. Appl. No. 16/147,047.
- USPTO; Non-Final Office Action dated Nov. 5, 2019 in U.S. Appl. No. 16/152,260.
- USPTO; Final Office Action dated Dec. 16, 2019 in U.S. Appl. No. 16/167,225.
- USPTO; Notice of Allowance dated Dec. 16, 2019 in U.S. Appl. No. 16/188,690.
- USPTO; Notice of Allowance dated Jan. 28, 2020 in U.S. Appl. No. 16/208,062.
- USPTO; Notice of Allowance dated Dec. 9, 2019 in U.S. Appl. No. 16/213,702.
- USPTO; Non-Final Office Action dated Jan. 8, 2020 in U.S. Appl. No. 16/219,555.
- USPTO; Non-Final Office Action dated Jan. 30, 2020 in U.S. Appl. No. 16/245,006.
- USPTO; Final Office Action dated Jan. 10, 2020 in U.S. Appl. No. 16/251,534.
- USPTO; Non-Final Office Action dated Dec. 18, 2019 in U.S. Appl. No. 16/280,964.
- USPTO; Non-Final Office Action dated Jan. 9, 2020 in U.S. Appl. No. 16/317,774.
- USPTO; Non-Final Office Action dated Dec. 26, 2019 in U.S. Appl. No. 16/417,938.
- USPTO; Non-Final Office Action dated Dec. 31, 2019 in U.S. Appl. No. 16/427,288.
- USPTO; Non-Final Office Action dated Dec. 31, 2019 in U.S. Appl. No. 16/455,406.
- USPTO; Ex Parte Quayle Action dated Dec. 17, 2019 in U.S. Appl. No. 29/615,000.
- USPTO; Notice of Allowance dated Jan. 23, 2020 in U.S. Appl. No. 29/634,768.
- WIPO; International Search Report and Written Opinion dated Nov. 19, 2019 in Application No. PCT/IB2019/000127.
- WIPO; International Search Report and Written Opinion dated Jan. 10, 2020 in Application No. PCT/IB2019/000729.
- WIPO; International Search Report and Written Opinion dated Dec. 20, 2019 in Application No. PCT/IB2019/000805.
- WIPO; International Search Report and Written Opinion dated Dec. 20, 2019 in Application No. PCT/IB2019/000817.
- Alen, "Atomic layer deposition of TaN, NbN and MoN films for Cu Metallizations," University of Helsinki Finland, 72 pages, (2005).
- Hamalainen et al., "Atomic Layer Deposition of Rhenium Disulfide," *Adv. Mater.* 30.24, 6 pages (2018).
- Hargreaves et al., "New Fluorides and Oxyfluorides of Rhenium," *J. Chem. Soc.*, pp. 1099-1103 (1960).
- IPS Water Heater Pan Adapter Kit, Nov. 1, 2015, [online], [site visited Dec. 4, 2019]; URL: <http://es.ipscorp.com/watertite/protectivesystem/whpanadapter> (2015).
- Qin et al., "Chemical Vapor Deposition Growth of Degenerate p-Type Mo-Doped ReS₂ Films and Their Homojunction," *ACS Appl. Mater. Interfaces*, 9(18), pp. 15583-15591 (2007).
- Rhenium trioxide; https://en.wikipedia.org/wiki/Rhenium_trioxide [online]; last edited on Feb. 18, 2017.
- Saeki et al. "Reaction Process of Vanadium Tetrachloride with Ammonia in the Vapor Phase and Properties of the Vanadium Nitride Formed" *Bull. Chem. Soc. Jpn.*, 55, pp. 3446-3449 (1982).
- CNIPA; Office Action dated Oct. 16, 2020 in Application No. 201610131743.1.

(56)

References Cited

OTHER PUBLICATIONS

- CNIPA; Office Action dated Jun. 16, 2020 in Application No. 201610897958.4.
- CNIPA; Office Action dated Jul. 3, 2020 in Application No. 201610898822.5.
- CNIPA; Notice of Allowance dated Oct. 9, 2020 in Application No. 201610898822.5.
- CNIPA; Notice of Allowance dated Nov. 4, 2020 in Application No. 201710173292.2.
- CNIPA; Office Action dated Aug. 31, 2020 in Application No. 201780044761.9.
- CNIPA; Office Action dated Apr. 27, 2020 in Application No. 201810379112.0.
- CNIPA; Office Action dated Apr. 27, 2020 in Application No. 201810836604.8.
- CNIPA; Office Action dated Jul. 30, 2020 in Application No. 201810836604.8.
- CNIPA; Office Action dated Apr. 22, 2020 in Application No. 201810994464.7.
- CNIPA; Notice of Allowance dated May 15, 2020 in Application No. 202030048854.3.
- CNIPA; Notice of Allowance dated Aug. 7, 2020 in Application No. 202030053609.1.
- EPO; Office Action dated Jul. 29, 2008 in Application No. 00902194.0.
- EPO; Office Action dated Jun. 27, 2003 in Application No. 97929595.3.
- EPO; Office Action dated Feb. 18, 2004 in Application No. 97929595.3.
- EPO; Notice of Allowance dated Apr. 29, 2004 in Application No. 97929595.3.
- EPO; Notice of Allowance dated Jan. 10, 2001 in Application No. 98911263.6.
- EPO; Office Action dated Jun. 6, 2001 in Application No. 98911277.6.
- EPO; Office Action dated Jun. 27, 2003 in Application No. 98967122.7.
- EPO; Notice of Allowance dated Feb. 23, 2004 in Application No. 98967122.7.
- EPO; Office Action dated Sep. 22, 2003 in Application No. 99946447.2.
- EPO; Office Action dated Nov. 25, 2003 in Application No. 99946447.2.
- EPO; Office Action dated Mar. 30, 2004 in Application No. 99946447.2.
- EPO; Office Action dated Jul. 19, 2004 in Application No. 99946447.2.
- EPO; Notice of Allowance dated Sep. 22, 2004 in Application No. 99946447.2.
- EPO; Supplementary European Search Report dated May 27, 2002 in Application No. 99973123.
- EPO; Notice of Allowance dated Jun. 11, 2004 in Application No. 99973123.
- JPO; Office Action dated Jun. 1, 2020 in Application No. 2016-206625.
- JPO; Office Action dated Aug. 28, 2020 in Application No. 2017-139817.
- JPO; Notice of Allowance dated Jul. 1, 2020 in Application No. 2019-025168.
- JPO; Office Action dated Aug. 24, 2020 in Application No. 2019-119908.
- JPO; Office Action dated Jun. 29, 2020 in Application No. 2020-502653.
- KIPO; Decision of Intellectual Property Trial and Appeal Board dated Jun. 23, 2020 in Application No. 10-2012-0076564.
- KIPO; Notice of Allowance dated Sep. 25, 2020 in Application No. 10-2013-0049598.
- KIPO; Notice of Allowance dated Aug. 13, 2020 in Application No. 10-2013-0098575.
- KIPO; Notice of Allowance dated Oct. 27, 2020 in Application No. 10-2014-0011764.
- KIPO; Office Action dated Jul. 21, 2020 in Application No. 10-2014-0011765.
- KIPO; Notice of Allowance dated Sep. 8, 2020 in Application No. 10-2014-0021615.
- KIPO; Office Action dated Oct. 26, 2020 in Application No. 10-2014-0027217.
- KIPO; Notice of Allowance dated Oct. 12, 2020 in Application No. 10-2014-0027305.
- KIPO; Office Action dated Jul. 9, 2020 in Application No. 10-2014-0060120.
- KIPO; Office Action dated Aug. 18, 2020 in Application No. 10-2014-0071653.
- KIPO; Notice of Allowance dated Oct. 19, 2020 in Application No. 10-2014-0086902.
- KIPO; Notice of Allowance dated Sep. 27, 2020 in Application No. 10-2014-0091092.
- KIPO; Office Action dated Oct. 5, 2020 in Application No. 10-2014-0103853.
- KIPO; Office Action dated Oct. 7, 2020 in Application No. 10-2014-0128626.
- KIPO; Office Action dated Jul. 21, 2020 in Application No. 10-2017-0087308.
- KIPO; Notice of Allowance dated Oct. 26, 2020 in Application No. 10-2017-0087308.
- KIPO; Office Action dated Jun. 30, 2020 in Application No. 10-2019-0044213.
- KIPO; Notice of Allowance dated Oct. 28, 2020 in Application No. 10-2020-0009462.
- KIPO; Notice of Allowance dated Jul. 20, 2020 in Application No. 10-2020-7000992.
- KIPO; Notice of Allowance dated Oct. 20, 2020 in Application No. 30-2019-0054013 M001.
- KIPO; Notice of Allowance dated Oct. 20, 2020 in Application No. 30-2019-0054013 M002.
- KIPO; Notice of Allowance dated Oct. 22, 2020 in Application No. 30-2019-0058076.
- TIPO; Notice of Allowance dated Jul. 1, 2020 in Application No. 105101537.
- TIPO; Notice of Allowance dated Sep. 4, 2020 in Application No. 105111990.
- TIPO; Office Action dated Sep. 7, 2020 in Application No. 105122394.
- TIPO; Notice of Allowance dated Aug. 31, 2020 in Application No. 105122586.
- TIPO; Office Action dated Sep. 18, 2020 in Application No. 105129977.
- TIPO; Notice of Allowance dated Sep. 25, 2020 in Application No. 105130130.
- TIPO; Office Action dated Aug. 25, 2020 in Application No. 105131284.
- TIPO; Office Action dated Aug. 25, 2020 in Application No. 105131896.
- TIPO; Office Action dated Sep. 30, 2020 in Application No. 105142668.
- TIPO; Office Action dated Aug. 11, 2020 in Application No. 106100823.
- TIPO; Office Action dated Jun. 17, 2020 in Application No. 106108152.
- TIPO; Office Action dated Oct. 7, 2020 in Application No. 106108522.
- TIPO; Office Action dated Aug. 21, 2020 in Application No. 106111548.
- TIPO; Office Action dated Oct. 8, 2020 in Application No. 106111693.
- TIPO; Office Action dated Sep. 30, 2020 in Application No. 106113604.
- TIPO; Office Action dated Jul. 15, 2020 in Application No. 106120365.
- TIPO; Office Action dated Nov. 12, 2020 in Application No. 106120365.
- TIPO; Office Action dated Nov. 18, 2020 in Application No. 106120902.
- TIPO; Office Action dated Oct. 8, 2020 in Application No. 106123203.
- TIPO; Office Action dated Jun. 24, 2020 in Application No. 108135004.
- TIPO; Office Action dated Jun. 29, 2020 in Application No. 108137226.
- TIPO; Office Action dated Jul. 9, 2020 in Application No. 108137227.

(56)

References Cited

OTHER PUBLICATIONS

TIPO; Office Action dated Aug. 17, 2020 in Application No. 108139018.
TIPO; Notice of Allowance dated Oct. 19, 2020 in Application No. 108306935.
TIPO; Notice of Allowance dated Oct. 19, 2020 in Application No. 108306935D01.
TIPO; Notice of Allowance dated Jul. 15, 2020 in Application No. 108307027.
TIPO; Notice of Allowance dated Oct. 19, 2020 in Application No. 108307027D01.
TIPO; Notice of Allowance dated Sep. 15, 2020 in Application No. 108307301.
TIPO; Notice of Allowance dated Sep. 25, 2020 in Application No. 108307759.
USPTO; Non-Final Office Action dated Mar. 28, 2001 in U.S. Appl. No. 09/452,844.
USPTO; Final Office Action dated Sep. 11, 2001 in U.S. Appl. No. 09/452,844.
USPTO; Advisory Action dated Jan. 24, 2002 in U.S. Appl. No. 09/452,844.
USPTO; Non-Final Office Action dated Apr. 9, 2002 in U.S. Appl. No. 09/452,844.
USPTO; Final Office Action dated Sep. 27, 2002 in U.S. Appl. No. 09/452,844.
USPTO; Notice of Allowance dated Jun. 17, 2003 in U.S. Appl. No. 09/452,844.
USPTO; Non-Final Office Action dated Oct. 31, 2003 in U.S. Appl. No. 09/452,844.
USPTO; Notice of Allowance dated Mar. 26, 2004 in U.S. Appl. No. 09/452,844.
USPTO; Non-Final Office Action dated Dec. 10, 2002 in U.S. Appl. No. 09/771,673.
USPTO; Final Office Action dated May 29, 2003 in U.S. Appl. No. 09/771,673.
USPTO; Final Office Action dated Feb. 6, 2004 in U.S. Appl. No. 09/771,673.
USPTO; Advisory Action dated Apr. 20, 2004 in U.S. Appl. No. 09/771,673.
USPTO; Notice of Allowance dated Jul. 29, 2004 in U.S. Appl. No. 09/771,673.
USPTO; Non-Final Office Action dated Jan. 3, 2002 in U.S. Appl. No. 09/807,580.
USPTO; Final Office Action dated Jun. 21, 2002 in U.S. Appl. No. 09/807,580.
USPTO; Advisory Action dated Aug. 27, 2002 in U.S. Appl. No. 09/807,580.
USPTO; Non-Final Action dated Nov. 27, 2002 in U.S. Appl. No. 09/807,580.
USPTO; Final Office Action dated May 27, 2003 in U.S. Appl. No. 09/807,580.
USPTO; Advisory Action dated Oct. 22, 2003 in U.S. Appl. No. 09/807,580.
USPTO; Examiner's Answer to Appeal Brief dated May 6, 2004 in U.S. Appl. No. 09/807,580.
USPTO; Decision on Appeal dated Feb. 16, 2005 in U.S. Appl. No. 09/807,580.
USPTO; Non-Final Action dated May 19, 2005 in U.S. Appl. No. 09/807,580.
USPTO; Final Action dated Nov. 21, 2005 in U.S. Appl. No. 09/807,580.
USPTO; Notice of Allowance dated Feb. 23, 2006 in U.S. Appl. No. 09/807,580.
USPTO; Non-Final Office Action dated May 13, 2003 in U.S. Appl. No. 10/222,229.
USPTO; Non-Final Office Action dated Feb. 9, 2004 in U.S. Appl. No. 10/603,515.
USPTO; Notice of Allowance dated Jun. 18, 2004 in U.S. Appl. No. 10/603,515.

USPTO; Non-Final Office Action dated Oct. 17, 2006 in U.S. Appl. No. 10/932,633.
USPTO; Non-Final Office Action dated Apr. 19, 2007 in U.S. Appl. No. 10/932,633.
USPTO; Notice of Allowance dated Sep. 10, 2007 in U.S. Appl. No. 10/932,633.
USPTO; Notice of Allowance dated Jul. 6, 2020 in U.S. Appl. No. 13/184,351.
USPTO; Examiner's Answer to Appeal Brief dated Apr. 20, 2018 in U.S. Appl. No. 13/187,300.
USPTO; Patent Board Decision dated Sep. 23, 2019 in U.S. Appl. No. 13/187,300.
USPTO; Advisory Action dated Nov. 10, 2015 in U.S. Appl. No. 14/079,302.
USPTO; Notice of Allowance dated Sep. 3, 2020 in U.S. Appl. No. 14/444,744.
USPTO; Notice of Allowance dated Aug. 6, 2020 in U.S. Appl. No. 14/457,058.
USPTO; Final Office Action dated Aug. 20, 2020 in U.S. Appl. No. 14/508,489.
USPTO; Notice of Allowance dated Nov. 3, 2020 in U.S. Appl. No. 14/508,489.
USPTO; Non-Final Office Action dated Aug. 3, 2020 in U.S. Appl. No. 14/829,565.
USPTO; Notice of Allowance dated Aug. 18, 2020 in U.S. Appl. No. 15/135,258.
USPTO; Non-Final Office Action dated Oct. 6, 2020 in U.S. Appl. No. 15/262,990.
USPTO; Final Office Action dated Oct. 2, 2020 in U.S. Appl. No. 15/286,503.
USPTO; Non-Final Office Action dated Sep. 2, 2020 in U.S. Appl. No. 15/377,439.
USPTO; Non-Final Office Action dated Jul. 1, 2020 in U.S. Appl. No. 15/380,909.
USPTO; Final Office Action dated Jul. 23, 2020 in U.S. Appl. No. 15/380,921.
USPTO; Final Office Action dated Sep. 8, 2020 in U.S. Appl. No. 15/402,993.
USPTO; Advisory Action dated Nov. 9, 2020 in U.S. Appl. No. 15/402,993.
USPTO; Non-Final Office Action dated Sep. 30, 2020 in U.S. Appl. No. 15/491,726.
USPTO; Final Office Action dated Jul. 8, 2020 in U.S. Appl. No. 15/589,861.
USPTO; Notice of Allowance dated Oct. 16, 2020 in U.S. Appl. No. 15/589,861.
USPTO; Final Office Action dated Sep. 16, 2020 in U.S. Appl. No. 15/611,707.
USPTO; Advisory Action dated Nov. 20, 2020 in U.S. Appl. No. 15/611,707.
USPTO; Non-Final Office Action dated Sep. 3, 2020 in U.S. Appl. No. 15/636,307.
USPTO; Notice of Allowance dated Jul. 2, 2020 in U.S. Appl. No. 15/672,096.
USPTO; Advisory Action dated Aug. 6, 2020 in U.S. Appl. No. 15/690,017.
USPTO; Non-Final Office Action dated Aug. 24, 2020 in U.S. Appl. No. 15/690,017.
USPTO; Non-Final Office Action dated Oct. 6, 2020 in U.S. Appl. No. 15/691,241.
USPTO; Final Office Action dated Sep. 24, 2020 in U.S. Appl. No. 15/726,959.
USPTO; Non-Final Office Action dated Jul. 10, 2020 in U.S. Appl. No. 15/798,201.
USPTO; Notice of Allowance dated Oct. 21, 2020 in U.S. Appl. No. 15/798,201.
USPTO; Non-Final Office Action dated Jul. 2, 2020 in U.S. Appl. No. 15/802,154.
USPTO; Notice of Allowance dated Oct. 26, 2020 in U.S. Appl. No. 15/802,154.
USPTO; Notice of Allowance dated Sep. 30, 2020 in U.S. Appl. No. 15/815,483.

(56)

References Cited

OTHER PUBLICATIONS

- USPTO; Final Office Action dated Sep. 17, 2020 in U.S. Appl. No. 15/835,328.
- USPTO; Final Office Action dated Aug. 6, 2020 in U.S. Appl. No. 15/835,352.
- USPTO; Notice of Allowance dated Aug. 17, 2020 in U.S. Appl. No. 15/843,899.
- USPTO; Notice of Allowance dated Jun. 30, 2020 in U.S. Appl. No. 15/860,564.
- USPTO; Notice of Allowance dated Aug. 19, 2020 in U.S. Appl. No. 15/861,418.
- USPTO; Non-Final Office Action dated Sep. 2, 2020 in U.S. Appl. No. 15/890,037.
- USPTO; Notice of Allowance dated Aug. 26, 2020 in U.S. Appl. No. 15/896,986.
- USPTO; Non-Final Office Action dated Sep. 9, 2020 in U.S. Appl. No. 15/909,705.
- USPTO; Final Office Action dated Sep. 24, 2020 in U.S. Appl. No. 15/917,224.
- USPTO; Non-Final Office Action dated Jul. 6, 2020 in U.S. Appl. No. 15/923,834.
- USPTO; Final Office Action dated Oct. 19, 2020 in U.S. Appl. No. 15/923,834.
- USPTO; Final Office Action dated Oct. 15, 2020 in U.S. Appl. No. 15/925,532.
- USPTO; Non-Final Office Action dated Oct. 6, 2020 in U.S. Appl. No. 15/940,729.
- USPTO; Non-Final Office Action dated Aug. 3, 2020 in U.S. Appl. No. 15/940,759.
- USPTO; Advisory Action dated Jul. 2, 2020 in U.S. Appl. No. 15/962,980.
- USPTO; Non-Final Office Action dated Sep. 14, 2020 in U.S. Appl. No. 15/962,980.
- USPTO; Non-Final Office Action dated Oct. 6, 2020 in U.S. Appl. No. 15/967,146.
- USPTO; Final Office Action dated Sep. 3, 2020 in U.S. Appl. No. 15/974,948.
- USPTO; Notice of Allowance dated Oct. 14, 2020 in U.S. Appl. No. 15/974,988.
- USPTO; Final Office Action dated Nov. 25, 2020 in U.S. Appl. No. 15/985,539.
- USPTO; Final Office Action dated Jul. 24, 2020 in U.S. Appl. No. 15/996,286.
- USPTO; Advisory Action dated Oct. 7, 2020 in U.S. Appl. No. 15/996,286.
- USPTO; Final Office Action dated Oct. 2, 2020 in U.S. Appl. No. 15/997,445.
- USPTO; Notice of Allowance dated Jul. 10, 2020 in U.S. Appl. No. 15/998,775.
- USPTO; Final Office Action dated Sep. 14, 2020 in U.S. Appl. No. 16/000,109.
- USPTO; Final Office Action dated Oct. 6, 2020 in U.S. Appl. No. 16/000,125.
- USPTO; Final Office Action dated Oct. 22, 2020 in U.S. Appl. No. 16/000,156.
- USPTO; Final Office Action dated Oct. 15, 2020 in U.S. Appl. No. 16/004,041.
- USPTO; Non-Final Office Action dated Sep. 8, 2020 in U.S. Appl. No. 16/039,817.
- USPTO; Non-Final Office Action dated Nov. 24, 2020 in U.S. Appl. No. 16/039,938.
- USPTO; Non-Final Office Action dated Aug. 4, 2020 in U.S. Appl. No. 16/042,791.
- USPTO; Final Office Action dated Jul. 30, 2020 in U.S. Appl. No. 16/055,532.
- USPTO; Final Office Action dated Nov. 3, 2020 in U.S. Appl. No. 16/055,532.
- USPTO; Notice of Allowance dated Sep. 14, 2020 in U.S. Appl. No. 16/100,012.
- USPTO; Advisory Action dated Aug. 25, 2020 in U.S. Appl. No. 16/105,745.
- USPTO; Non-Final Office Action dated Nov. 25, 2020 in U.S. Appl. No. 16/105,745.
- USPTO; Advisory Action dated Jul. 8, 2020 in U.S. Appl. No. 16/105,761.
- USPTO; Non-Final Office Action dated Nov. 25, 2020 in U.S. Appl. No. 16/105,761.
- USPTO; Final Office Action dated Nov. 17, 2020 in U.S. Appl. No. 16/105,802.
- USPTO; Non-Final Office Action dated Sep. 8, 2020 in U.S. Appl. No. 16/108,950.
- USPTO; Final Office Action dated Sep. 2, 2020 in U.S. Appl. No. 16/116,708.
- USPTO; Advisory Action dated Nov. 17, 2020 in U.S. Appl. No. 16/116,708.
- USPTO; Final Office Action dated Nov. 19, 2020 in U.S. Appl. No. 16/128,282.
- USPTO; Notice of Allowance dated Aug. 5, 2020 in U.S. Appl. No. 16/130,798.
- USPTO; Advisory Action dated Aug. 24, 2020 in U.S. Appl. No. 16/132,142.
- USPTO; Non-Final Office Action dated Oct. 16, 2020 in U.S. Appl. No. 16/132,142.
- USPTO; Final Office Action dated Aug. 20, 2020 in U.S. Appl. No. 16/137,974.
- USPTO; Notice of Allowance dated Nov. 3, 2020 in U.S. Appl. No. 16/137,974.
- USPTO; Non-Final Office Action dated Jul. 30, 2020 in U.S. Appl. No. 16/151,074.
- USPTO; Advisory Action dated Sep. 16, 2020 in U.S. Appl. No. 16/152,260.
- USPTO; Final Office Action dated Jul. 15, 2020 in U.S. Appl. No. 16/152,260.
- USPTO; Non-Final Office Action dated Nov. 9, 2020 in U.S. Appl. No. 16/152,260.
- USPTO; Notice of Allowance dated Jul. 24, 2020 in U.S. Appl. No. 16/158,077.
- USPTO; Non-Final Office Action dated Jul. 23, 2020 in U.S. Appl. No. 16/167,164.
- USPTO; Non-Final Office Action dated Aug. 7, 2020 in U.S. Appl. No. 16/172,535.
- USPTO; Final Office Action dated Oct. 16, 2020 in U.S. Appl. No. 16/172,535.
- USPTO; Non-Final Office Action dated Nov. 4, 2020 in U.S. Appl. No. 16/176,517.
- USPTO; Non-Final Office Action dated Oct. 29, 2020 in U.S. Appl. No. 16/183,258.
- USPTO; Notice of Allowance dated Jul. 28, 2020 in U.S. Appl. No. 16/193,789.
- USPTO; Notice of Allowance dated Jul. 7, 2020 in U.S. Appl. No. 16/194,041.
- USPTO; Final Office Action dated Nov. 27, 2020 in U.S. Appl. No. 16/205,899.
- USPTO; Non-Final Office Action dated Jul. 15, 2020 in U.S. Appl. No. 16/210,922.
- USPTO; Advisory Action dated Sep. 11, 2020 in U.S. Appl. No. 16/219,555.
- USPTO; Non-Final Office Action dated Sep. 30, 2020 in U.S. Appl. No. 16/219,555.
- USPTO; Advisory Action dated Aug. 11, 2020 in U.S. Appl. No. 16/242,829.
- USPTO; Notice of Allowance dated Sep. 23, 2020 in U.S. Appl. No. 16/242,829.
- USPTO; Non-Final Office Action dated Sep. 3, 2020 in U.S. Appl. No. 16/242,852.
- USPTO; Final Office Action dated Oct. 14, 2020 in U.S. Appl. No. 16/251,534.
- USPTO; Final Office Action dated Nov. 18, 2020 in U.S. Appl. No. 16/252,567.
- USPTO; Notice of Allowance dated Aug. 6, 2020 in U.S. Appl. No. 16/255,639.

(56)

References Cited

OTHER PUBLICATIONS

- USPTO; Notice of Allowance dated Aug. 5, 2020 in U.S. Appl. No. 16/258,187.
- USPTO; Final Office Action dated Jun. 30, 2020 in U.S. Appl. No. 16/356,394.
- USPTO; Notice of Allowance dated Aug. 31, 2020 in U.S. Appl. No. 16/356,394.
- USPTO; Non-Final Office Action dated Aug. 5, 2020 in U.S. Appl. No. 16/397,045.
- USPTO; Non-Final Office Action dated Aug. 19, 2020 in U.S. Appl. No. 16/400,814.
- USPTO; Notice of Allowance dated Sep. 18, 2020 in U.S. Appl. No. 16/454,063.
- USPTO; Non-Final Office Action dated Nov. 27, 2020 in U.S. Appl. No. 16/468,258.
- USPTO; Non-Final Office Action dated Nov. 5, 2020 in U.S. Appl. No. 16/546,543.
- USPTO; Notice of Allowance dated Sep. 16, 2020 in U.S. Appl. No. 16/598,768.
- USPTO; Non-Final Office Action dated Oct. 16, 2020 in U.S. Appl. No. 16/679,885.
- USPTO; Non-Final Office Action dated Nov. 16, 2020 in U.S. Appl. No. 16/713,311.
- USPTO; Final Office Action dated Oct. 2, 2020 in U.S. Appl. No. 16/833,279.
- USPTO; Non-Final Office Action dated Jul. 9, 2020 in U.S. Appl. No. 16/897,158.
- USPTO; Notice of Allowance dated Nov. 12, 2020 in U.S. Appl. No. 16/897,158.
- USPTO; Non-Final Office Action dated Aug. 4, 2020 in U.S. Appl. No. 16/926,192.
- USPTO; Final Office Action dated Sep. 9, 2020 in U.S. Appl. No. 29/726,623.
- USPTO; Notice of Allowance dated Nov. 23, 2020 in U.S. Appl. No. 29/726,623.
- WIPO; International Search Report dated Oct. 13, 1998 in Application No. PCT/FI1998/000571.
- WIPO; International Search Report dated Jul. 13, 1990 in Application No. PCT/NL1990/000027.
- WIPO; International Search Report dated Jan. 11, 1990 in Application No. PCT/NL1990/000042.
- WIPO; International Search Report dated Feb. 26, 1991 in Application No. PCT/NL1990/000166.
- WIPO; International Search Report dated Oct. 25, 1991 in Application No. PCT/NL1991/000108.
- WIPO; International Search Report dated Oct. 17, 1997 in Application No. PCT/NL1997/000398.
- WIPO; International Preliminary Examination Report dated Oct. 2, 1998 in Application No. PCT/NL1997/000398.
- WIPO; International Search Report dated Apr. 24, 1998 in Application No. PCT/NL1998/000055.
- WIPO; International Preliminary Examination Report dated Feb. 24, 1999 in Application No. PCT/NL1998/000055.
- WIPO; International Search Report dated May 27, 1998 in Application No. PCT/NL1998/000105.
- WIPO; International Search Report dated May 8, 1998 in Application No. PCT/NL1998/000151.
- WIPO; International Preliminary Examination Report dated Mar. 23, 1999 in Application No. PCT/NL1998/000151.
- WIPO; International Search Report dated May 27, 1998 in Application No. PCT/NL1998/000167.
- WIPO; International Preliminary Examination Report dated Jul. 13, 1999 in Application No. PCT/NL1998/000167.
- WIPO; International Search Report dated Jul. 8, 1998 in Application No. PCT/NL1998/000204.
- WIPO; International Search Report dated Aug. 21, 1998 in Application No. PCT/NL1998/000246.
- WIPO; International Search Report dated Oct. 16, 1998 in Application No. PCT/NL1998/000383.
- WIPO; International Preliminary Examination Report dated Sep. 16, 1999 in Application No. PCT/NL1998/000383.
- WIPO; International Search Report dated Apr. 15, 1999 in Application No. PCT/NL1999/000047.
- WIPO; International Search Report dated Oct. 12, 1999 in Application No. PCT/NL1999/000487.
- WIPO; International Search Report dated Dec. 16, 1999 in Application No. PCT/NL1999/000583.
- WIPO; Written Opinion dated Jul. 24, 2000 in Application No. PCT/NL1999/000583.
- WIPO; International Preliminary Examination Report dated Jan. 22, 2001 in Application No. PCT/NL1999/000583.
- WIPO; International Search Report dated Apr. 19, 2000 in Application No. PCT/NL2000/000020.
- WIPO; Written Opinion dated Oct. 17, 2000 in Application No. PCT/NL2000/000020.
- WIPO; International Search Report dated Dec. 16, 1999 in Application No. PCT/RU1999/000328.
- WIPO; International Preliminary Examination Report dated Jun. 29, 2001 in Application No. PCT/RU1999/000328.
- Akiyama et al. "Macro- and micro-scale simulation of growth rate and composition in MOCVD of yttria-stabilized zirconia" *J. Crystal Growth* 241, pp. 352-362 (2002).
- Altiere et al. "Review Article: Plasma-surface interactions at the atomic scale for patterning metals" *J. Vac. Sci. Technol. A* 35, 05C203, 13 pages (2017).
- Ande et al. "Role of Surface Termination in Atomic Layer Deposition of Silicon Nitride" *J. Phys. Chem. Lett.* 6(18), 16 pages (2015).
- Atta et al. "The Catalytic Activity of Ruthenates ARuO₃ (A=Ca, Sr or Ba) for the Hydrogen Evolution Reaction in Acidic Medium" *Int. J. Electrochem. Sci.* 7, pp. 725-746 (2012).
- Ballal "Mass Transfer in Porous Solids under Pulsating Pressure Conditions" *SLJ International*, vol. 35, Nov. 4, pp. 446-448 (1995).
- Brewin et al. "UPS to deploy Bluetooth, wireless LAN network" *Internet*, pp. 1-5 (2001).
- Bulletin Plasma Source—Dec. 2002: Type AX7610—Downstream Plasma Source. Source location: MKS Instruments, Inc. <http://www.mksinst.com/>. Accessed: Aug. 6, 2015. pp. 1-4 (2002).
- Bulletin ASTRONe—Apr. 2002: Type AX7680—Reactive Gas Generator. Source location: MKS Instruments, Inc. <http://www.mksinst.com/>. Accessed: Aug. 6, 2015. pp. 1-2 (2002).
- Bulletin ASTRONex—Jul. 2009: Type AX7685—Reactive Gas Generator. Source location: MKS Instruments, Inc. <http://www.mksinst.com/>. Accessed: Aug. 6, 2015. pp. 1-2 (2002).
- Bulletin ASTRON hf-s—Mar. 2005: Type AX7645—Reactive Gas Generator. Source location: MKS Instruments, Inc. <http://www.mksinst.com/>. Accessed: Aug. 6, 2015. pp. 1-2 (2005).
- Bulletin ENG-XSTREAM-340-09 OM Aug. 2006: Xstream with Active Matching Network Remote Plasma Source. Advanced Energy Industries, Inc. <http://www.advanced-energy.net.cn/upload/File/Sources/ENG-Xstream-340-09.pdf>. Accessed: Jul. 19, 2016. pp. 1-4 (2006).
- Bulletin R*evolution—Sep. 2006: Type AX7690—Remote Plasma Source. Source location: MKS Instruments, Inc. <http://www.mksinst.com/>. Accessed: Aug. 6, 2015. pp. 1-2 (2006).
- Callaghan et al. "Magnetic Interactions in Ternary Ruthenium Oxides" *Inorganic Chemistry*, vol. 5, No. 9, pp. 1572-1576 (1966).
- Choi et al. "UV irradiation effects on the bonding structure and electrical properties of ultra low-k SiOC(-H) thin films for 45 nm technology node" *Current Applied Physics*, 11, S109-S113 (2011).
- Closser et al., "Molecular Layer Deposition of a Highly Stable Silicon Oxycarbide Thin Film Using an Organic Chlorosilane and Water," *ACS Applied Materials & Interfaces* 10, pp. 24266-24274 (2018).
- Crystal IS "Application Note: Using UV Reflective Materials to Maximize Disinfection"; AN011; Jun. 16, 2016, found at <https://www.klaran.com/using-uv-reflective-materials-to-maximize-disinfection>.
- Dufond et al. "Quantifying the Extent of Ligand Incorporation and the Effect on Properties of TiO₂ Thin Films Grown by Atomic

(56)

References Cited

OTHER PUBLICATIONS

- Layer Deposition Using an Alkoxide or an Alkylamide" *Chemistry of Material*, American Chemical Society 32(4), pp. 1393-1407 (2020).
- Dultsev et al. "Effect of UV radiation on the reactivity of porous methyl-doped SiO₂ layers" *Phys. Status Solidi C*, 8, No. 6, pp. 1946-1949 (2011).
- Esposito et al. "Preparation and characterization of lead ruthenate based composite cathodes for SOFC applications" *Mater. Res. Soc. Symp. Proc.*, vol. 835, 6 pages (2005).
- Fray et al. "Aspects of the Application of Electrochemistry to the Extraction of Titanium and Its Applications" *Materials Transactions*, vol. 58, No. 3, pp. 306-312 (2017)
- Freund et al. "Single crystal growth from separated educts and its application to lithium transition-metal oxides" *Sci. Rep.* 6, 35362, pp. 1-5 (2016).
- Frequently Asked Question, "What is a load lock chamber?", Kurt J. Lesker Company, www.lesker.com, p. 1 (2020).
- Hong et al. "Ultralow-dielectric-constant amorphous boron nitride" *Nature*, vol. 582, 16 pages (2020).
- Hubert et al., "A Stacked SONOS Technology, up to 4 Levels and 6nm Crystalline Nanowires, With Gate-All-Around or Independent Gates (-Flash), Suitable for Full 3D Integration," *Minatec, IEDM09-637-640* (2009).
- Ivanova et al. "ALD of Sc₂O₃ using Sc(Cp)₃ and a Novel Heteroleptic Precursors" Presented on the AVS 19th International Conference on Atomic Layer Deposition, Jul. 23, 2019, Abstract, 1 page (2019).
- Johnson et al. "A brief review of atomic layer deposition: from fundamentals to applications" *Materials Today*, vol. 17, Issue 5, pp. 236-246 (2014).
- Juppo et al. "Deposition of molybdenum thin films by an alternate supply of MoCl₅ and Zn" *J of Vacuum Science & Technology A*, 16, pp. 2845-2850 (1998).
- Katamreddy et al., "ALD and Characterization of Aluminum Oxide Deposited on Si(100) using Tris(diethylamino) Aluminum and Water Vapor," *Journal of the Electrochemical Society*, 153 (10) C701-C706 (2006).
- Kim et al. "Thermal Decomposition of Tetrakis(ethylmethylamido) Titanium for Chemical Vapor Deposition of Titanium Nitride" *Bull. Korean Chem. Soc.*, vol. 27, No. 2, 5 pages (2006).
- Kirsch et al. "Dipole model explaining high-k/metal gate field effect transistor threshold voltage tuning" *Applied Physics Letters* 92, 092901, 3 pages (2008).
- Kjesbu, ABB Corporate Research, Internet, pp. 1-37 (2002).
- Kofuji et al. "Line-edge roughness increase due to wiggling enhanced by initial pattern waviness" *Jpn. J. Appl. Phys.* 53, 03DE01, pp. 1-7 (2014).
- Kofuji et al. "Mechanism of wiggling enhancement due to HBr gas addition during amorphous carbon etching" *Jpn. J. Appl. Phys.* 54, 06FH04, p. 107 (2015).
- Kovalgin et al. "Hot-Wire Assisted ALD: A Study Powered by In Situ Spectroscopic Ellipsometry" *Adv. Mater. Interfaces* 4, 1700058, 11 pages (2017).
- Krumdieck et al. "Experimental Characterization and Modeling of Pulsed MOCVD with Ultrasonic Atomization of Liquid Precursor" *Chem. Vap. Deposition*, 7 (2), pp. 85-90 (2001).
- Krumdieck "Kinetic Model of Low Pressure Film Deposition from Single Precursor Vapor in a Well-Mixed, Cold-Wall Reactor" *Acta mater.*, 49, pp. 583-588 (2001).
- Kuchumov et al. "Pulsed MO CVD Processes of MgO Layer Deposition from Mg(thd)₂" *ECS Trans.* 25, pp. 927-934 (2009).
- Kukli et al. "Atomic Layer Deposition and Chemical Vapor Deposition of Tantalum Oxide by Successive and Simultaneous Pulsing of Tantalum Ethoxide and Tantalum Chloride" *Chem. Mater.* 12, pp. 1914-1920 (2000).
- Kukli et al. "Atomic Layer Epitaxy Growth of Tantalum Oxide Thin Films from Ta(OC₂H₅)₅ and H₂O" *The Electrochemical Society*, vol. 142, No. 5, pp. 1670-1674 (1995).
- Kumar et al. "Bringing the benefits of Java to Bluetooth" <http://www.allembedded.com/story/OEG20020519S001>, pp. 1-3 (2002).
- Mameli et al. "Area-Selective Atomic Layer Deposition of SiO₂ Using Acetylacetone as a Chemoselective Inhibitor in an ABC-Type Cycle" *ACS Nano* 11, pp. 9303-9311 (2017).
- Mameli et al. "Isotropic Atomic Layer Etching of ZnO Using Acetylacetone and O₂ Plasma" *ACS Appl. Mater. Interfaces* 10, pp. 38588-38595 (2018).
- Naslain et al. "Synthesis of highly tailored ceramic matrix composites by pressure-pulsed CVI" *Solid State Ionics*, 141-142, pp. 541-548 (2001).
- Niinisto et al. "Advanced electronic and optoelectronic materials by Atomic Layer Deposition: An overview with special emphasis on recent progress in processing of high-k dielectrics and other oxide materials" *Pus. Stat. Sol. (a)* 201, No. 7, pp. 1443-1452 (2004).
- Ohzawa et al. "Preparation of fibrous SiC shape using pressure-pulsed chemical vapour infiltration and its properties as a high-temperature filter" *J. of Materials Processing Technology*, 96, pp. 151-156 (1999).
- O'Malley et al. "Structure and properties of ordered Li₂IrO₃ and Li₂PtO₃" *Journal of Solid State Chemistry* 181, pp. 1803-1809 (2008).
- Park et al. "Atomic layer deposition of Y₂O₃ films using heteroleptic liquid (iPrCp)2Y(iPr-amd) precursor" *J. Mater. Chem. C*, 2, 9 pages (2014).
- Peters et al., "Aerosol-Assisted Chemical Vapor Deposition of NbS₂ and TaS₂ Thin Films from Pentakis(dimethylamido)metal Complexes and 2-Methylpropanethiol" *Eur. J. Inorg. Chem.*, pp. 4179-4185 (2005).
- Posseme et al. "Alternative process for thin layer etching: Application to nitride spacer etching stopping on silicon germanium" *Apply. Phys. Lett.* 105, 051604, pp. 1-4 (2014).
- Provine et al. "Atomic Layer Deposition: Introduction to the Theory and Cambridge Nanotech Savannah & Fiji" NNIN ALD Roadshow Presentation, 49 pages (2012).
- Rosemount 1199 Diaphragm Seal Systems, Product Data Sheet, 92 pages (2008).
- Senateur et al. "Pulsed Injection MOCVD of Functional Electronic Oxides" *Adv. Mater. Opt. Electron*, 10, pp. 155-161 (2000).
- Shevtsov et al. "An Apparatus for Pulse Chemical Vapor Deposition of Layers" *Instruments and Experimental Techniques*, vol. 56, No. 3, pp. 353-357 (2013).
- Shevtsov et al. "Effect of Spatial Image Transfer in a Pulse MOCVD Process" *Physics Procedia* 46, pp. 27-32 (2013).
- Stannowski et al. "Growth process and properties of silicon nitride deposited by hot-wire chemical vapor deposition" *J Applied Physics*, vol. 93 No. 5, 9 pages (2013).
- Tomozeiu et al. "Effects of UV photon irradiation on SiO_x (0<x<2) structural properties" *Applied Surface Science* 253, pp. 376-380 (2006).
- U.S. Appl. No. 60/394,086, filed Jul. 3, 2002 in the name of Jacques Schmitt, and entitled "ALD on a Rotary Susceptor" pp. 1-23 (2002).
- U.S. Appl. No. 62/293,897, filed Feb. 11, 2016 in the names of Bernardo Donoso et al., and entitled "Vapor Based Site-Isolated Processing Systems and Methods" pp. 1-51 (2016).
- Vallat et al. "Area selective deposition of TiO₂ by intercalation of plasma etching cycles in PEALD process: A bottom up approach for the simplification of 3D integration scheme" *Journal of Vacuum Science & Technology A* 37(2), 12 pages (2019).
- Vallat et al. "Selective deposition of Ta₂O₅ by adding plasma etching super-cycles in plasma enhanced atomic layer deposition steps" *Journal of Vacuum Science & Technology A* 35(1), 7 pages (2016)
- Venkatesan et al. "A rugged lead-ruthenate pyrochlore membrane catalyst for highly selective oxidation of alcohols" *J. Molecular Catalysis A: Chemical* 250, pp. 87-93 (2006).
- Xiao "Introduction to Semiconductor Manufacturing Technology" SPIE Press, ISBN 978-0-08194-9092-6, pp. 237-245 (2012).
- Yuan et al. "A Bifunctional Air Electrode Catalyzed by Lead Ruthenate for Li-Air Batteries" *ECS Transactions* 69(19), pp. 23-32 (2015).

(56)

References Cited

OTHER PUBLICATIONS

Zhao et al. "Surface Chemistry of Thermal Dry Etching of Cobalt Thin Films Using Hexafluoroacetylacetone (hfach)" Appl Surf Sci. 455, pp. 438-445 (2018).

Zhao et al. "Thermal and Plasma-Enhanced Atomic Layer Deposition of Yttrium Oxide Films and the Properties of Water Wettability" Appl. Mater. Interfac. 12(2), 9 pages (2019).

CNIPA; Notice of Allowance dated Dec. 21, 2020 in Application No. 201610982040.X.

CNIPA; Office Action dated Nov. 20, 2020 in Application No. 201710762817.6.

CNIPA; Notice of Allowance dated Dec. 28, 2020 in Application No. 201930704935.1.

CNIPA; Notice of Allowance dated Dec. 10, 2020 in Application No. 202030352604.9.

CNIPA; Office Action dated Jan. 25, 2021 in Application No. 202030579755.8.

JPO; Notice of Allowance dated Nov. 27, 2020 in Application No. 2016-206625.

JPO; Office Action dated Jan. 26, 2021 in Application No. 2017-139817.

JPO; Notice of Allowance dated Nov. 26, 2020 in Application No. 2020-502653.

KIPO; Office Action dated Jan. 25, 2021 in Application No. 10-2014-0011765.

KIPO; Notice of Allowance dated Jan. 4, 2021 in Application No. 10-2014-0060120.

KIPO; Notice of Allowance dated Jan. 4, 2021 in Application No. 10-2014-0071653.

KIPO; Office Action dated Nov. 29, 2020 in Application No. 10-2014-0105478.

KIPO; Office Action dated Feb. 17, 2021 in Application No. 10-2014-0122903.

KIPO; Office Action dated Jan. 25, 2021 in Application No. 10-2014-0145220.

KIPO; Office Action dated Jan. 6, 2021 in Application No. 10-2015-0025314.

KIPO; Office Action dated Dec. 23, 2020 in Application No. 10-2019-0044213.

KIPO; Office Action dated Nov. 14, 2020 in Application No. 10-2020-0101096.

KIPO; Notice of Allowance dated Oct. 20, 2020 in Application No. 30-2019-0054642.

KIPO; Notice of Allowance dated Oct. 22, 2020 in Application No. 30-2019-0058566 (M001).

KIPO; Notice of Allowance dated Oct. 22, 2020 in Application No. 30-2019-0058566 (M002).

KIPO; Notice of Allowance dated Dec. 1, 2020 in Application No. 30-2019-0061607.

KIPO; Office Action dated Jan. 26, 2021 in Application No. 30-2020-0005953 (M001).

KIPO; Office Action dated Jan. 26, 2021 in Application No. 30-2020-0005953 (M002).

KIPO; Notice of Allowance dated Dec. 23, 2020 in Application No. 30-2020-0006059.

KIPO; Notice of Allowance dated Dec. 25, 2020 in Application No. 30-2020-0006223.

KIPO; Notice of Allowance dated Feb. 1, 2021 in Application No. 30-2020-0006385.

KIPO; Notice of Allowance dated Feb. 1, 2021 in Application No. 30-2020-0006391.

TIPO; Office Action dated Dec. 2, 2020 in Application No. 105131896.

TIPO; Notice of Allowance dated Jan. 29, 2021 in Application No. 105142668.

TIPO; Notice of Allowance dated Dec. 10, 2020 in Application No. 106108152.

TIPO; Notice of Allowance dated Jan. 25, 2021 in Application No. 106111548.

TIPO; Office Action dated Jan. 6, 2021 in Application No. 106115126.

TIPO; Office Action dated Dec. 21, 2020 in Application No. 106122231.

TIPO; Office Action dated Dec. 29, 2020 in Application No. 106124126.

TIPO; Office Action dated Dec. 9, 2020 in Application No. 106124128.

TIPO; Office Action dated Jan. 25, 2021 in Application No. 106124129.

TIPO; Office Action dated Dec. 9, 2020 in Application No. 106124130.

TIPO; Office Action dated Jan. 20, 2021 in Application No. 106129491.

TIPO; Office Action dated Feb. 8, 2021 in Application No. 106133152.

TIPO; Office Action dated Dec. 24, 2019 in Application No. 108105002.

TIPO; Notice of Allowance dated Nov. 24, 2020 in Application No. 108307599.

TIPO; Notice of Allowance dated Jan. 11, 2021 in Application No. 108307599D01.

TIPO; Notice of Allowance dated Jan. 11, 2021 in Application No. 109300591.

TIPO; Notice of Allowance dated Jan. 11, 2021 in Application No. 109300593.

TIPO; Office Action dated Jan. 11, 2021 in Application No. 109300594.

USPTO; Non-Final Office Action dated Dec. 1, 2020 in U.S. Appl. No. 14/219,879.

USPTO; Final Office Action dated Feb. 1, 2021 in U.S. Appl. No. 14/829,565.

USPTO; Non-Final Office Action dated Dec. 24, 2020 in U.S. Appl. No. 15/286,503.

USPTO; Final Office Action dated Feb. 12, 2021 in U.S. Appl. No. 15/377,439.

USPTO Non-Final Office Action dated Dec. 10, 2020 in U.S. Appl. No. 15/380,921.

USPTO; Non-Final Office Action dated Feb. 3, 2021 in U.S. Appl. No. 15/611,707.

USPTO; Final Office Action dated Jan. 19, 2021 in U.S. Appl. No. 15/636,307.

USPTO; Non-Final Office Action dated Jan. 6, 2021 in U.S. Appl. No. 15/726,959.

USPTO; Advisory Action dated Dec. 15, 2020 in U.S. Appl. No. 15/835,328.

USPTO; Notice of Allowance dated Jan. 14, 2021 in U.S. Appl. No. 15/835,352.

USPTO; Final Office Action dated Jan. 11, 2021 in U.S. Appl. No. 15/890,037.

USPTO; Advisory Action dated Jan. 8, 2021 in U.S. Appl. No. 15/923,834.

USPTO; Advisory Action dated Dec. 24, 2020 in U.S. Appl. No. 15/925,532.

USPTO; Non-Final Office Action dated Jan. 25, 2021 in U.S. Appl. No. 15/925,532.

USPTO; Final Office Action dated Feb. 18, 2021 in U.S. Appl. No. 15/940,729.

USPTO; Final Office Action dated Jan. 12, 2021 in U.S. Appl. No. 15/940,759.

USPTO; Final Office Action dated Dec. 15, 2020 in U.S. Appl. No. 15/962,980.

USPTO; Advisory Action dated Oct. 27, 2020 in U.S. Appl. No. 15/974,948.

USPTO; Advisory Action dated Dec. 10, 2020 in U.S. Appl. No. 16/000,109.

USPTO; Advisory Action dated Dec. 15, 2020 in U.S. Appl. No. 16/000,125.

USPTO; Advisory Action dated Dec. 14, 2020 in U.S. Appl. No. 16/000,156.

USPTO; Advisory Action dated Dec. 22, 2020 in U.S. Appl. No. 16/004,041.

USPTO; Advisory Action dated Jan. 14, 2021 in U.S. Appl. No. 16/055,532.

USPTO; Final Office Action dated Dec. 15, 2020 in U.S. Appl. No. 16/108,950.

USPTO; Final Office Action dated Jan. 6, 2021 in U.S. Appl. No. 16/117,530.

USPTO; Notice of Allowance dated Feb. 12, 2021 in U.S. Appl. No. 16/128,282.

(56)

References Cited

OTHER PUBLICATIONS

- USPTO; Notice of Allowance dated Feb. 8, 2021 in U.S. Appl. No. 16/132,142.
- USPTO; Final Office Action dated Dec. 14, 2020 in U.S. Appl. No. 16/151,074.
- USPTO; Advisory Action dated Feb. 16, 2021 in U.S. Appl. No. 16/151,074.
- USPTO; Final Office Action dated Dec. 18, 2020 in U.S. Appl. No. 16/167,164.
- USPTO; Advisory Action dated Dec. 21, 2020 in U.S. Appl. No. 16/172,535.
- USPTO; Final Office Action dated Jan. 29, 2021 in U.S. Appl. No. 16/176,517.
- USPTO; Non-Final Office Action dated Dec. 11, 2021 in U.S. Appl. No. 16/202,941.
- USPTO; Final Office Action dated Dec. 9, 2020 in U.S. Appl. No. 16/210,922.
- USPTO; Notice of Allowance dated Dec. 15, 2020 in U.S. Appl. No. 16/242,852.
- USPTO; Advisory Action dated Jan. 22, 2021 in U.S. Appl. No. 16/252,567.
- USPTO; Final Office Action dated Dec. 8, 2020 in U.S. Appl. No. 16/397,045.
- USPTO; Advisory Action dated Jan. 27, 2021 in U.S. Appl. No. 16/397,045.
- USPTO; Final Office Action dated Dec. 14, 2020 in U.S. Appl. No. 16/400,814.
- USPTO; Non-Final Office Action dated Jan. 12, 2021 in U.S. Appl. No. 16/453,249.
- USPTO; Non-Final Office Action dated Dec. 28, 2020 in U.S. Appl. No. 16/517,122.
- USPTO; Non-Final Office Action dated Feb. 11, 2021 in U.S. Appl. No. 16/565,460.
- USPTO; Notice of Allowance dated Jan. 25, 2021 in U.S. Appl. No. 16/679,885.
- USPTO; Non-Final Office Action dated Feb. 8, 2021 in U.S. Appl. No. 16/685,787.
- USPTO; Non-Final Office Action dated Jan. 8, 2021 in U.S. Appl. No. 16/752,514.
- USPTO; Notice of Allowance dated Dec. 28, 2020 in U.S. Appl. No. 16/833,279.
- Aoyagi et al. "Laser-assisted atomic layer epitaxy" *Materials Science and Engineering*, pp. 121-132 (1991).
- Galesic et al. "Formation of vanadium nitride by rapid thermal processing" *Thin Solid Films* 349(1), 7 pages (1999).
- Kim et al. "High Growth Rate in Atomic Layer Deposition of TiO₂ Thin Films by UV Irradiation" *Electrochemical and Solid-State Letters*, 14(4), pp. H146-H148 (2011).
- Lee et al. "Enhancement of Iodine Adsorption on Ruthenium Glue Layer for Seedless CECVD of Cu" *Electrochemical and Solid-State Letters*, 8(2) C39-C42 (2005).
- Lee et al. "Growth without Postannealing of Monoclinic VO₂ Thin Film by Atomic Layer Deposition Using VC14 as Precursor" *Coatings*, 8, 431, pp. 1-11 (2018).
- Lee et al. "Photo-Induced Atomic Layer Deposition of Tantalum Oxide Thin Films from Ta(OC₂H₅)₅ and O₂" *J of the Electrochemical Society*. 151(1) pp. C52-C55 (2004).
- Merdrignac-Conanec et al. "Nitridation under ammonia of high surface area vanadium aerogels" *Journal of Solid State Chemistry* 178(1), 8 pages (2005).
- Nikolic et al. "The dependence of the work function of rare earth metals on their electron structure" *Microelectronics Journal* 27, 93-96 (1996).
- Putkonen et al. "Low-Temperature ALE Deposition of Y₂O₃ Thin Films from β -Diketonate Precursors" *Chemical Vapor Deposition* 7(1) pp. 44-50 (2001).
- U.S. Appl. No. 62/274,238, filed Jan. 1, 2016 in the names of Alexander S. Polyak et al., and entitled "Non-Metallic Thermal CVD/ALD Gas Injector and Purge System" pp. 1-63 (2016).
- Vayrynen et al. "Photo-Assisted Atomic Layer Deposition and Chemical Vapor Deposition of Metal and Metal Oxide Thin Films" Thesis, Oct. 2015, 146 pages (2005).
- CNIPA; Office Action dated Jan. 10, 2013 in Application No. 201080015699.9.
- CNIPA; Office Action dated Aug. 1, 2013 in Application No. 201080015699.9.
- CNIPA; Office Action dated Jan. 21, 2014 in Application No. 201080015699.9.
- CNIPA; Office Action dated Jul. 25, 2014 in Application No. 201080015699.9.
- CNIPA; Office Action dated Jan. 12, 2015 in Application No. 201080015699.9.
- CNIPA; Notice of Allowance dated May 8, 2015 in Application No. 201080015699.9.
- CNIPA; Office Action dated Dec. 10, 2013 in Application No. 201080020267.7.
- CNIPA; Notice of Allowance dated Aug. 22, 2014 in Application No. 201080020267.7.
- CNIPA; Office Action dated Jan. 21, 2013 in Application No. 201080020268.1.
- CNIPA; Office Action dated Sep. 26, 2013 in Application No. 201080020268.1.
- CNIPA; Office Action dated Apr. 3, 2014 in Application No. 201080020268.1.
- CNIPA; Office Action dated Sep. 23, 2014 in Application No. 201080020268.1.
- CNIPA; Office Action dated Apr. 7, 2015 in Application No. 201080020268.1.
- CNIPA; Notice of Allowance dated Oct. 16, 2015 in Application No. 201080020268.1.
- CNIPA; Office Action dated May 24, 2013 in Application No. 201080036764.6.
- CNIPA; Office Action dated Jan. 2, 2014 in Application No. 201080036764.6.
- CNIPA; Office Action dated Jul. 1, 2014 in Application No. 201080036764.6.
- CNIPA; Notice of Allowance dated Oct. 24, 2014 in Application No. 201080036764.6.
- CNIPA; Office Action dated Feb. 8, 2014 in Application No. 201110155056.0.
- CNIPA; Office Action dated Sep. 16, 2014 in Application No. 201110155056.0.
- CNIPA; Office Action dated Feb. 9, 2015 in Application No. 201110155056.0.
- CNIPA; Notice of Allowance dated Aug. 26, 2015 in Application No. 201110155056.0.
- CNIPA; Office Action dated Dec. 4, 2015 in Application No. 201210201995.9.
- CNIPA; Office Action dated Jul. 14, 2016 in Application No. 201210201995.9.
- CNIPA; Office Action dated Jan. 20, 2017 in Application No. 201210201995.9.
- CNIPA; Notice of Allowance dated Apr. 13, 2017 in Application No. 201210201995.9.
- CNIPA; Office Action dated Dec. 24, 2015 in Application No. 201280057466.4.
- CNIPA; Notice of Allowance dated Jun. 16, 2016 in Application No. 201280057466.4.
- CNIPA; Office Action dated Dec. 4, 2015 in Application No. 201280057542.1.
- CNIPA; Office Action dated May 16, 2016 in Application No. 201280057542.1.
- CNIPA; Office Action dated Sep. 9, 2016 in Application No. 201280057542.1.
- CNIPA; Notice of Allowance dated Jan. 3, 2017 in Application No. 201280057542.1.
- CNIPA; Office Action dated Dec. 5, 2016 in Application No. 201310412808.6.
- CNIPA; Notice of Allowance dated Jul. 20, 2017 in Application No. 201310412808.6.
- CNIPA; Office Action dated Feb. 5, 2018 in Application No. 201410331047.6.

(56)

References Cited

OTHER PUBLICATIONS

- CNIPA; Office Action dated Dec. 14, 2018 in Application No. 201410331047.6.
- CNIPA; Notice of Allowance dated Jun. 14, 2019 in Application No. 201410331047.6.
- CNIPA; Office Action dated Jun. 28, 2019 in Application No. 201510765170.3.
- CNIPA; Office Action dated Oct. 19, 2018 in Application No. 201510765170.3.
- CNIPA; Office Action dated Oct. 31, 2018 in Application No. 201510765406.3.
- CNIPA; Office Action dated Jun. 28, 2019 in Application No. 201510765406.3.
- CNIPA; Office Action dated Mar. 14, 2019 in Application No. 201610141027.1.
- CNIPA; Office Action dated Dec. 20, 2018 in Application No. 201710738549.4.
- CNIPA; Office Action dated Jun. 20, 2019 in Application No. 201711120632.1.
- CNIPA; Notice of Allowance dated May 25, 2017 in Application No. 201730010308.9.
- CNIPA; Notice of Allowance dated Oct. 24, 2018 in Application No. 201830060972.9.
- CNIPA; Notice of Allowance dated Nov. 1, 2018 in Application No. 201830397219.9.
- EPO; Supplementary European Search Report and Opinion dated Nov. 9, 2012 in Application No. 08798519.8.
- EPO; Office Action dated Jul. 18, 2016 in Application No. 08798519.8.
- EPO; Extended European Search Report dated Dec. 9, 2016 in Application No. 9767208.3.
- EPO; Office Action dated Aug. 10, 2018 in Application No. 09767208.3.
- EPO; Supplementary European Search Report and Opinion dated Jan. 5, 2017 in Application No. 09836647.9.
- EPO; Office Action dated Feb. 28, 2018 in Application No. 09836647.9.
- EPO; Office Action dated Jan. 11, 2019 in Application No. 09836647.9.
- EPO; Extended European Search Report dated Apr. 28, 2014 in Application No. 11162225.4.
- EPO; Notice of Allowance dated Feb. 3, 2015 in Application No. 11162225.4.
- IPOS; Notice of Allowance dated Aug. 14, 2017 in Application No. 10201401237.
- JPO; Office Action dated Aug. 10, 2009 in Application No. 2003029767.
- JPO; Office Action dated Apr. 13, 2010 in Application No. 2003029767.
- JPO; Notice of Allowance dated Jun. 24, 2010 in Application No. 2003029767.
- JPO; Office Action dated Oct. 30, 2008 in Application No. 2004558313.
- JPO; Office Action dated Feb. 19, 2009 in Application No. 2004558313.
- JPO; Notice of Allowance dated Jun. 30, 2009 in Application No. 2004558313.
- JPO; Office Action dated Mar. 16, 2012 in Application No. 2009-532567.
- JPO; Notice of Allowance dated Jul. 23, 2012 in Application No. 2009-532567.
- JPO; Notice of Allowance dated Mar. 29, 2013 in Application No. 2010-509478.
- JPO; Office Action dated Dec. 20, 2011 in Application No. 2010-522075.
- JPO; Office Action dated Apr. 11, 2012 in Application No. 2010-522075.
- JPO; Office Action dated May 15, 2013 in Application No. 2010058415.
- JPO; Office Action dated Oct. 30, 2013 in Application No. 2010058415.
- JPO; Office Action dated Aug. 7, 2014 in Application No. 2010058415.
- JPO; Notice of Allowance dated Dec. 18, 2014 in Application No. 2010058415.
- JPO; Office Action dated Aug. 22, 2013 in Application No. 2010-153754.
- JPO; Office Action dated Oct. 30, 2013 in Application No. 2010-193285.
- JPO; Office Action dated Aug. 26, 2015 in Application No. 2011-284831.
- JPO; Notice of Allowance dated Mar. 3, 2016 in Application No. 2011-284831.
- JPO; Office Action dated May 31, 2012 in Application No. 2011-514650.
- JPO; Office Action dated Sep. 11, 2012 in Application No. 2011-514650.
- JPO; Notice of Allowance dated Dec. 10, 2012 in Application No. 2011-514650.
- JPO; Office Action dated Dec. 10, 2014 in Application No. 2011090067.
- JPO; Notice of Allowance dated Apr. 28, 2015 in Application No. 2011090067.
- JPO; Office Action dated Jul. 14, 2016 in Application No. 2012-153698.
- JPO; Notice of Allowance dated Oct. 21, 2016 in Application No. 2012-153698.
- JPO; Office Action dated Dec. 20, 2013 in Application No. 2012-504786.
- JPO; Office Action dated Jan. 25, 2014 in Application No. 2012-504786.
- JPO; Office Action dated Dec. 1, 2014 in Application No. 2012-504786.
- JPO; Notice of Allowance dated Jun. 12, 2015 in Application No. 2012504786.
- JPO; Office Action dated Mar. 11, 2013 in Application No. 2012-509857.
- JPO; Notice of Allowance dated Jun. 29, 2013 in Application No. 2012-509857.
- JPO; Office Action dated May 19, 2017 in Application No. 2013-160173.
- JPO; Notice of Allowance dated Aug. 23, 2017 in Application No. 2013-160173.
- JPO; Office Action dated Aug. 14, 2017 in Application No. 2013-178344.
- JPO; Office Action dated Jan. 23, 2018 in Application No. 2013-178344.
- JPO; Notice of Allowance dated Jul. 24, 2018 in Application No. 2013-178344.
- JPO; Office Action dated Apr. 3, 2018 in Application No. 2014-120675.
- JPO; Notice of Allowance dated Jun. 6, 2018 in Application No. 2014-120675.
- JPO; Office Action dated Mar. 28, 2018 in Application No. 2014-188835.
- JPO; Notice of Allowance dated Jun. 6, 2018 in Application No. 2014-188835.
- JPO; Office Action dated Apr. 12, 2018 in Application No. 2014-205548.
- JPO; Notice of Allowance dated Dec. 19, 2019 in Application No. 2014205548.
- JPO; Notice of Allowance dated May 14, 2018 in Application No. 2014-216540.
- JPO; Office Action dated Jul. 20, 2018 in Application No. 2015-034774.
- JPO; Office Action dated Jun. 27, 2019 in Application No. 2015034774.
- JPO; Office Action dated Jan. 30, 2019 in Application No. 2015052198.
- JPO; Notice of Allowance dated Apr. 5, 2019 in Application No. 2015052198.
- KIPO; Office Action dated Dec. 10, 2015 in Application No. 10-2010-0028336.
- KIPO; Office Action dated Jun. 29, 2016 in Application No. 10-2010-0028336.
- KIPO; Notice of Allowance dated Sep. 29, 2016 in Application No. 10-2010-0028336.
- KIPO; Office Action dated Mar. 3, 2016 in Application No. 10-2010-0067768.
- KIPO; Office Action dated Aug. 1, 2016 in Application No. 10-2010-0067768.
- KIPO; Notice of Allowance dated Dec. 1, 2016 in Application No. 10-2010-0067768.

(56)

References Cited

OTHER PUBLICATIONS

KIPO; Office Action dated May 2, 2016 in Application No. 10-2010-0082446.
 KIPO; Office Action dated Sep. 19, 2016 in Application No. 10-2010-0082446.
 KIPO; Notice of Allowance dated Mar. 7, 2017 in Application No. 10-2010-0082446.
 KIPO; Office Action dated Mar. 13, 2017 in Application No. 20110034612.
 KIPO; Office Action dated Jul. 20, 2017 in Application No. 20110034612.
 KIPO; Notice of Allowance dated Sep. 1, 2017 in Application No. 20110034612.
 KIPO; Office Action dated Nov. 24, 2017 in Application No. 10-2011-0036449.
 KIPO; Office Action dated May 23, 2017 in Application No. 10-2011-0036449.
 KIPO; Office Action dated Apr. 2, 2018 in Application No. 10-2011-0036449.
 KIPO; Notice of Allowance dated Oct. 24, 2018 in Application No. 10-2011-0036449.
 KIPO; Office Action dated Sep. 4, 2017 in Application No. 10-2011-0087600.
 KIPO; Notice of Allowance dated Jan. 11, 2018 in Application No. 10-2011-0087600.
 KIPO; Office Action dated Oct. 23, 2017 in Application No. 10-2011-0142924.
 KIPO; Notice of Allowance dated Mar. 14, 2018 in Application No. 10-2011-0142924.
 KIPO; Office Action dated Dec. 11, 2015 in Application No. 10-2011-7023416.
 KIPO; Office Action dated Mar. 13, 2016 in Application No. 10-2011-7023416.
 KIPO; Notice of Allowance dated Jun. 2, 2016 in Application No. 10-2011-7023416.
 KIPO; Office Action dated Mar. 21, 2018 in Application No. 10-2012-0004520.
 KIPO; Office Action dated Oct. 30, 2017 in Application No. 10-2012-0041878.
 KIPO; Notice of Allowance dated Feb. 28, 2018 in Application No. 10-2012-0041878.
 KIPO; Office Action dated Mar. 21, 2018 in Application No. 10-2012-0042518.
 KIPO; Notice of Allowance dated May 30, 2018 in Application No. 10-2012-0042518.
 KIPO; Office Action dated Mar. 21, 2018 in Application No. 10-2012-0064526.
 KIPO; Office Action dated Sep. 18, 2018 in Application No. 10-2012-0064526.
 KIPO; Office Action dated Dec. 13, 2018 in Application No. 10-2012-0064526.
 KIPO; Office Action dated Jan. 12, 2019 in Application No. 10-2012-0064526.
 KIPO; Office Action dated Mar. 30, 2018 in Application No. 10-2012-0076564.
 KIPO; Office Action dated Sep. 27, 2018 in Application No. 10-2012-0076564.
 KIPO; Office Action dated Mar. 27, 2019 in Application No. 10-2012-0076564.
 KIPO; Office Action dated Apr. 30, 2018 in Application No. 10-2012-0103114.
 KIPO; Notice of Allowance dated Nov. 22, 2018 in Application No. 10-2012-0103114.
 KIPO; Office Action dated Oct. 24, 2016 in Application No. 10-2012-7004062.
 KIPO; Office Action dated Jul. 24, 2017 in Application No. 10-2012-7004062.
 KIPO; Office Action dated Sep. 28, 2017 in Application No. 10-2014-7017112.

KIPO; Notice of Allowance dated Feb. 23, 2018 in Application No. 10-2014-7017112.
 KIPO; Office Action dated May 30, 2019 in Application No. 10-2012-7004062.
 KIPO; Decision of Intellectual Property Trial and Appeal Board dated May 13, 2019 in Application No. 10-2012-7004062.
 KIPO; Office Action dated Apr. 19, 2019 in Application No. 10-2013-0101944.
 KIPO; Office Action dated Apr. 24, 2019 in Application No. 10-2013-0036823.
 KIPO; Office Action dated May 31, 2019 in Application No. 10-2013-0050740.
 KIPO; Office Action dated Mar. 27, 2019 in Application No. 10-2013-0084459.
 KIPO; Office Action dated Apr. 30, 2019 in Application No. 10-2013-0088450.
 KIPO; Office Action dated May 21, 2019 in Application No. 10-2013-0121554.
 KIPO; Office Action dated Jan. 22, 2019 in Application No. 10-2014-7017110.
 KIPO; Office Action dated Nov. 9, 2016 in Application No. 10-2016-7023913.
 KIPO; Notice of Allowance dated May 30, 2017 in Application No. 10-2016-7023913.
 KIPO; Notice of Allowance dated Feb. 27, 2018 in Application No. 10-2017-0175442.
 KIPO; Office Action dated Sep. 28, 2017 in Application No. 10-2017-7023740.
 KIPO; Notice of Allowance dated Jul. 19, 2018 in Application No. 20187013945.
 KIPO; Office Action dated Sep. 15, 2017 in Application No. 30-2017-0001320.
 KIPO; Notice of Allowance dated Jan. 19, 2018 in Application No. 30-2017-0001320.
 KIPO; Notice of Allowance dated Jul. 10, 2018 in Application No. 30-2017-0052872.
 KIPO; Office Action dated Jul. 11, 2018 in Application No. 30-2018-0006016.
 KIPO; Notice of Allowance dated Oct. 16, 2018 in Application No. 30-2018-0006016.
 KIPO; Office Action dated Jan. 30, 2019 in Application No. 30-2018-0033442.
 KIPO; Notice of Allowance dated Apr. 1, 2019 in Application No. 30-2018-0033442.
 TIPO; Office Action dated Aug. 30, 2013 in Application No. 97132391.
 TIPO; Office Action dated Dec. 20, 2013 in Application No. 98117513.
 TIPO; Notice of Allowance dated Jun. 12, 2014 in Application No. 98117513.
 TIPO; Office Action dated Jul. 4, 2014 in Application No. 99110511.
 TIPO; Notice of Allowance dated Feb. 24, 2016 in Application No. 99110511.
 TIPO; Office Action dated Aug. 27, 2014 in Application No. 99114329.
 TIPO; Notice of Allowance dated Jan. 28, 2015 in Application No. 99114329.
 TIPO; Office Action dated Dec. 26, 2014 in Application No. 99114330.
 TIPO; Notice of Allowance dated Apr. 28, 2015 in Application No. 99114330.
 TIPO; Office Action dated Aug. 14, 2014 in Application No. 99114331.
 TIPO; Notice of Allowance dated Oct. 16, 2015 in Application No. 99114331.
 TIPO; Office Action dated Dec. 19, 2014 in Application No. 99127063.
 TIPO; Notice of Allowance dated Mar. 14, 2016 in Application No. 99127063.
 TIPO; Notice of Allowance dated Oct. 2, 2015 in Application No. 100130472.
 TIPO; Office Action dated Feb. 19, 2016 in Application No. 100113130.

(56)

References Cited

OTHER PUBLICATIONS

TIPO; Notice of Allowance dated Jun. 29, 2016 in Application No. 100113130.
TIPO; Notice of Allowance dated Nov. 2, 2016 in Application No. 101142581.
TIPO; Office Action dated Apr. 28, 2016 in Application No. 101142582.
TIPO; Notice of Allowance dated Aug. 19, 2016 in Application No. 101142582.
TIPO; Office Action dated Aug. 1, 2016 in Application No. 101124745.
TIPO; Notice of Allowance dated Oct. 19, 2016 in Application No. 101124745.
TIPO; Office Action dated Sep. 19, 2016 in Application No. 102113028.
TIPO; Notice of Allowance dated Feb. 13, 2017 in Application No. 102113028.
TIPO; Office Action dated Aug. 2016 in Application No. 102115605.
TIPO; Office Action dated Feb. 24, 2017 in Application No. 102115605.
TIPO; Notice of Allowance dated Dec. 26, 2017 in Application No. 102115605.
TIPO; Office Action dated Nov. 15, 2016 in Application No. 102125191.
TIPO; Office Action dated Jun. 20, 2017 in Application No. 102125191.
TIPO; Office Action dated Dec. 6, 2016 in Application No. 102126071.
TIPO; Office Action dated May 17, 2018 in Application No. 102126071.
TIPO; Notice of Allowance dated Aug. 24, 2018 in Application No. 102126071.
TIPO; Office Action dated Feb. 10, 2017 in Application No. 102127065.
TIPO; Notice of Allowance dated Jul. 18, 2017 in Application No. 102127065.
TIPO; Office Action dated Nov. 3, 2016 in Application No. 102129262.
TIPO; Notice of Allowance dated Mar. 3, 2017 in Application No. 102129262.
TIPO; Office Action dated Dec. 29, 2016 in Application No. 102129397.
TIPO; Notice of Allowance dated Aug. 29, 2017 in Application No. 102129397.
TIPO; Office Action dated Nov. 3, 2016 in Application No. 102131839.
TIPO; Notice of Allowance dated Jan. 26, 2017 in Application No. 102131839.
TIPO; Office Action dated Dec. 2, 2016 in Application No. 102136496.
TIPO; Office Action dated Jan. 10, 2018 in Application No. 102136496.
TIPO; Office Action dated Nov. 11, 2016 in Application No. 102132952.
TIPO; Notice of Allowance dated Apr. 19, 2017 in Application No. 102132952.
TIPO; Office Action dated Jul. 17, 2017 in Application No. 103101400.
TIPO; Notice of Allowance dated Jan. 24, 2018 in Application No. 103101400.
TIPO; Office Action dated Feb. 23, 2017 in Application No. 103102563.
TIPO; Notice of Allowance dated Nov. 30, 2017 in Application No. 103102563.
TIPO; Office Action dated Mar. 03, 2017 in Application No. 103105251.
TIPO; Notice of Allowance dated Oct. 20, 2017 in Application No. 103105251.
TIPO; Office Action dated Nov. 1, 2017 in Application No. 103106021.
TIPO; Notice of Allowance dated Apr. 10, 2018 in Application No. 103106021.
TIPO; Office Action dated Oct. 31, 2017 in Application No. 103106022.
TIPO; Notice of Allowance dated Apr. 10, 2018 in Application No. 103106022.
TIPO; Office Action dated Jul. 5, 2017 in Application No. 103117477.
TIPO; Notice of Allowance dated Jan. 22, 2018 in Application No. 103117477.

TIPO; Office Action dated Nov. 22, 2017 in Application No. 103117478.
TIPO; Notice of Allowance dated Mar. 13, 2018 in Application No. 103117478.
TIPO; Office Action dated May 19, 2017 in Application No. 103120478.
TIPO; Notice of Allowance dated Sep. 25, 2017 in Application No. 103120478.
TIPO; Office Action dated Sep. 20, 2018 in Application No. 103123439.
TIPO; Office Action dated Nov. 8, 2017 in Application No. 103124509.
TIPO; Notice of Allowance dated Apr. 25, 2018 in Application No. 103124509.
TIPO; Office Action dated Nov. 20, 2017 in Application No. 103127588.
TIPO; Notice of Allowance dated Jun. 19, 2018 in Application No. 103127588.
TIPO; Office Action dated Sep. 19, 2017 in Application No. 103127734.
TIPO; Notice of Allowance dated Dec. 11, 2017 in Application No. 103127734.
TIPO; Office Action dated Sep. 26, 2018 in Application No. 103132230.
TIPO; Notice of Allowance dated Jan. 30, 2019 in Application No. 103132230.
TIPO; Office Action dated Nov. 22, 2017 in Application No. 103134537.
TIPO; Notice of Allowance dated Apr. 19, 2018 in Application No. 103134537.
TIPO; Office Action dated Aug. 24, 2017 in Application No. 103136251.
TIPO; Notice of Allowance dated Oct. 17, 2017 in Application No. 103136251.
TIPO; Office Action dated Feb. 26, 2018 in Application No. 103138510.
TIPO; Notice of Allowance dated Jun. 13, 2018 in Application No. 103138510.
TIPO; Office Action dated May 21, 2018 in Application No. 103139014.
TIPO; Notice of Allowance dated Sep. 11, 2018 in Application No. 103139014.
TIPO; Office Action dated Jun. 22, 2018 in Application No. 104105533.
TIPO; Office Action dated Feb. 22, 2019 in Application No. 104105533.
TIPO; Office Action dated Nov. 19, 2018 in Application No. 104105965.
TIPO; Office Action dated Jul. 9, 2018 in Application No. 104107876.
TIPO; Notice of Allowance dated May 9, 2019 in Application No. 104107876.
TIPO; Office Action dated Aug. 7, 2018 in Application No. 104107888.
TIPO; Notice of Allowance dated Apr. 26, 2019 in Application No. 104107888.
TIPO; Office Action dated May 6, 2019 in Application No. 104108277.
TIPO; Office Action dated Jul. 9, 2018 in Application No. 104110326.
TIPO; Notice of Allowance dated May 8, 2019 in Application No. 104110326.
TIPO; Office Action dated Jun. 13, 2018 in Application No. 104111910.
TIPO; Notice of Allowance dated Sep. 18, 2018 in Application No. 104111910.
TIPO; Office Action dated Apr. 29, 2019 in Application No. 104122889.
TIPO; Office Action dated Jan. 30, 2019 in Application No. 104122890.
TIPO; Office Action dated Jul. 11, 2018 in Application No. 104124377.
TIPO; Notice of Allowance dated Jun. 19, 2019 in Application No. 104124377.
TIPO; Office Action dated Jan. 7, 2019 in Application No. 104132991.
TIPO; Notice of Allowance dated Apr. 12, 2019 in Application No. 104132991.
TIPO; Office Action dated Apr. 25, 2019 in Application No. 104141679.
TIPO; Office Action dated Apr. 25, 2019 in Application No. 105101536.

(56)

References Cited

OTHER PUBLICATIONS

TIPO; Notice of Allowance dated May 7, 2019 in Application No. 105104453.
TIPO; Notice of Allowance dated Dec. 5, 2017 in Application No. 105308015.
TIPO; Notice of Allowance dated Apr. 11, 2018 in Application No. 105308015D01.
TIPO; Office Action dated Nov. 6, 2017 in Application No. 106117181.
TIPO; Notice of Allowance dated Jun. 5, 2018 in Application No. 106117181.
TIPO; Office Action dated Sep. 28, 2018 in Application No. 106119537.
TIPO; Office Action dated Dec. 26, 2018 in Application No. 106127690.
TIPO; Office Action dated Aug. 31, 2018 in Application No. 106138119.
TIPO; Office Action dated Jun. 25, 2018 in Application No. 106138800.
TIPO; Office Action dated Jan. 7, 2019 in Application No. 106138800.
TIPO; Office Action dated Oct. 3, 2018 in Application No. 106142731.
TIPO; Office Action dated Sep. 28, 2018 in Application No. 107112951.
TIPO; Office Action dated Nov. 20, 2018 in Application No. 107118271.
TIPO; Office Action dated Jun. 4, 2019 in Application No. 107123992.
TIPO; Office Action dated May 28, 2019 in Application No. 107125586.
TIPO; Notice of Allowance dated Aug. 29, 2018 in Application No. 107300633.
TIPO; Notice of Allowance dated Feb. 21, 2019 in Application No. 107303723.
TIPO; Office Action dated May 31, 2019 in Application No. 108102146.
USPTO; Notice of Allowance dated Jul. 26, 2005 in U.S. Appl. No. 10/033,058.
USPTO; Non-Final Office Action dated Aug. 25, 2005 in U.S. Appl. No. 10/191,635.
USPTO; Final Office Action dated Apr. 25, 2006 in U.S. Appl. No. 10/191,635.
USPTO; Non-Final Office Action dated Nov. 20, 2006 in U.S. Appl. No. 10/191,635.
USPTO; Notice of Allowance dated May 21, 2007 in U.S. Appl. No. 10/191,635.
USPTO; Notice of Allowance dated Feb. 20, 2008 in U.S. Appl. No. 10/191,635.
USPTO; Non-Final Office Action dated Oct. 22, 2003 in U.S. Appl. No. 10/222,229.
USPTO; Final Office Action dated Mar. 22, 2004 in U.S. Appl. No. 10/222,229.
USPTO; Advisory Action dated Oct. 7, 2004 in U.S. Appl. No. 10/222,229.
USPTO; Non-Final Office Action dated Dec. 22, 2004 in U.S. Appl. No. 10/222,229.
USPTO; Final Office Action dated Jun. 20, 2005 in U.S. Appl. No. 10/222,229.
USPTO; Advisory Action dated Nov. 16, 2005 in U.S. Appl. No. 10/222,229.
USPTO; Notice of Allowance dated Mar. 8, 2006 in U.S. Appl. No. 10/222,229.
USPTO; Non-Final Office Action dated Jan. 26, 2005 in U.S. Appl. No. 10/838,510.
USPTO; Notice of Allowance dated Jul. 12, 2005 in U.S. Appl. No. 10/838,510.
USPTO; Office Action dated Feb. 15, 2011 in U.S. Appl. No. 12/118,596.
USPTO; Notice of Allowance dated Aug. 4, 2011 in U.S. Appl. No. 12/118,596.
USPTO; Non-Final Office Action dated Apr. 28, 2010 in U.S. Appl. No. 12/121,085.
USPTO; Notice of Allowance dated Jul. 26, 2010 in U.S. Appl. No. 12/121,085.

USPTO; Notice of Allowance dated Oct. 4, 2010 in U.S. Appl. No. 12/121,085.
USPTO; Non-Final Office Action dated Sep. 13, 2010 in U.S. Appl. No. 12/140,809.
USPTO; Final Office Action dated Dec. 28, 2010 in U.S. Appl. No. 12/140,809.
USPTO; Notice of Allowance dated Mar. 17, 2011 in U.S. Appl. No. 12/140,809.
USPTO; Non-Final Office Action dated Mar. 15, 2011 in U.S. Appl. No. 12/193,924.
USPTO; Foma; Office Action dated Sep. 30, 2011 in U.S. Appl. No. 12/193,924.
USPTO; Non-Final Office Action dated Oct. 24, 2012 in U.S. Appl. No. 12/193,924.
USPTO; Final Office Action dated Apr. 17, 2013 in U.S. Appl. No. 12/193,924.
USPTO; Advisory Action dated Jul. 09, 2013 in U.S. Appl. No. 12/193,924.
USPTO; Non-Final Office Action dated Jul. 28, 2011 in U.S. Appl. No. 12/330,096.
USPTO; Final Office Action dated Jan. 13, 2012 in U.S. Appl. No. 12/330,096.
USPTO; Notice of Allowance dated Mar. 6, 2012 in U.S. Appl. No. 12/330,096.
USPTO; Non-Final Office Action dated Mar. 20, 2012 in U.S. Appl. No. 12/330,096.
USPTO; Notice of Allowance dated Jun. 7, 2012 in U.S. Appl. No. 12/330,096.
USPTO; Non-Final Office Action dated Apr. 1, 2010 in U.S. Appl. No. 12/357,174.
USPTO; Final Office Action dated Sep. 1, 2010 in U.S. Appl. No. 12/357,174.
USPTO; Notice of Allowance dated Dec. 13, 2010 in U.S. Appl. No. 12/357,174.
USPTO; Non-Final Office Action dated Dec. 29, 2010 in U.S. Appl. No. 12/362,023.
USPTO; Non-Final Office Action dated Jul. 26, 2011 in U.S. Appl. No. 12/416,809.
USPTO; Final Office Action dated Dec. 6, 2011 in U.S. Appl. No. 12/416,809.
USPTO; Notice of Allowance dated Apr. 2, 2012 in U.S. Appl. No. 12/416,809.
USPTO; Advisory Action dated Feb. 3, 2012 in U.S. Appl. No. 12/416,809.
USPTO; Notice of Allowance dated Jun. 16, 2011 in U.S. Appl. No. 12/430,751.
USPTO; Notice of Allowance dated Jul. 27, 2011 in U.S. Appl. No. 12/430,751.
USPTO; Non-Final Office Action dated Aug. 3, 2011 in U.S. Appl. No. 12/436,300.
USPTO; Final Office Action dated Jan. 23, 2012 in U.S. Appl. No. 12/436,300.
USPTO; Advisory Action dated Mar. 6, 2012 in U.S. Appl. No. 12/436,300.
USPTO; Non-Final Office Action dated May 22, 2012 in U.S. Appl. No. 12/436,300.
USPTO; Notice of Allowance dated Nov. 28, 2012 in U.S. Appl. No. 12/436,300.
USPTO; Non-Final Office Action dated Apr. 11, 2012 in U.S. Appl. No. 12/436,306.
USPTO; Final Office Action dated Sep. 26, 2012 in U.S. Appl. No. 12/436,306.
USPTO; Non-Final Office Action dated May 31, 2013 in U.S. Appl. No. 12/436,306.
USPTO; Final Office Action dated Oct. 17, 2013 in U.S. Appl. No. 12/436,306.
USPTO; Non-Final Office Action dated Feb. 4, 2014 in U.S. Appl. No. 12/436,306.
USPTO; Final Office Action dated Jun. 23, 2014 in U.S. Appl. No. 12/436,306.
USPTO; Advisory Action dated Oct. 1, 2014 in U.S. Appl. No. 12/436,306.

(56)

References Cited

OTHER PUBLICATIONS

- USPTO; Non-Final Office Action dated Feb. 3, 2015 in U.S. Appl. No. 12/436,306.
- USPTO; Final Office Action dated May 13, 2015 in U.S. Appl. No. 12/436,306.
- USPTO; Non-Final Office Action dated Oct. 14, 2015 in U.S. Appl. No. 12/436,306.
- USPTO; Final Office Action dated Dec. 31, 2015 in U.S. Appl. No. 12/436,306.
- USPTO; Notice of Allowance dated Feb. 3, 2016 in U.S. Appl. No. 12/436,306.
- USPTO; Non-Final Office Action dated Aug. 3, 2011 in U.S. Appl. No. 12/436,315.
- USPTO; Notice of Allowance dated Nov. 17, 2011 in U.S. Appl. No. 12/436,315.
- USPTO; Notice of Allowance dated Oct. 1, 2010 in U.S. Appl. No. 12/467,017.
- USPTO; Non-Final Office Action dated Mar. 18, 2010 in U.S. Appl. No. 12/489,252.
- USPTO; Notice of Allowance dated Sep. 2, 2010 in U.S. Appl. No. 12/489,252.
- USPTO; Non-Final Office Action dated Dec. 15, 2010 in U.S. Appl. No. 12/553,759.
- USPTO; Final Office Action dated May 4, 2011 in U.S. Appl. No. 12/553,759.
- USPTO; Advisory Action dated Jul. 13, 2011 in U.S. Appl. No. 12/553,759.
- USPTO; Non-Final Office Action dated Sep. 6, 2011 in U.S. Appl. No. 12/553,759.
- USPTO; Notice of Allowance dated Jan. 27, 2012 in U.S. Appl. No. 12/553,759.
- USPTO; Non-Final Office Action dated Oct. 19, 2012 in U.S. Appl. No. 12/618,355.
- USPTO; Final Office Action dated May 8, 2013 in U.S. Appl. No. 12/618,355.
- USPTO; Advisory Action dated Jul. 23, 2013 in U.S. Appl. No. 12/618,355.
- USPTO; Non-Final Office Action dated Apr. 8, 2015 in U.S. Appl. No. 12/618,355.
- USPTO; Final Office Action dated Oct. 22, 2015 in U.S. Appl. No. 12/618,355.
- USPTO; Advisory Action dated Mar. 4, 2016 in U.S. Appl. No. 12/618,355.
- USPTO; Non-Final Office Action dated Jun. 30, 2016 in U.S. Appl. No. 12/618,355.
- USPTO; Final Office Action dated Feb. 10, 2017 in U.S. Appl. No. 12/618,355.
- USPTO; Advisory Action dated May 16, 2017 in U.S. Appl. No. 12/618,355.
- USPTO; Non-Final Office Action dated Nov. 29, 2017 in U.S. Appl. No. 12/618,355.
- USPTO; Final Office Action dated Aug. 10, 2018 in U.S. Appl. No. 12/618,355.
- USPTO; Notice of Allowance dated Apr. 4, 2019 in U.S. Appl. No. 12/618,355.
- USPTO; Non-Final Office Action dated Feb. 16, 2012 in U.S. Appl. No. 12/618,419.
- USPTO; Final Office Action dated Jun. 22, 2012 in U.S. Appl. No. 12/618,419.
- USPTO; Non-Final Office Action dated Nov. 27, 2012 in U.S. Appl. No. 12/618,419.
- USPTO; Advisory Action dated Aug. 9, 2012 in U.S. Appl. No. 12/618,419.
- USPTO; Notice of Allowance dated Apr. 12, 2013 in U.S. Appl. No. 12/618,419.
- USPTO; Non-Final Office Action dated Jun. 12, 2013 in U.S. Appl. No. 12/618,419.
- USPTO; Notice of Allowance dated Oct. 9, 2013 in U.S. Appl. No. 12/618,419.
- USPTO; Non-Final Office Action dated Dec. 6, 2011 in U.S. Appl. No. 12/718,731.
- USPTO; Notice of Allowance dated Mar. 16, 2012 in U.S. Appl. No. 12/718,731.
- USPTO; Office Action dated Feb. 26, 2013 in U.S. Appl. No. 12/754,223.
- USPTO; Final Office Action dated Jun. 28, 2013 in U.S. Appl. No. 12/754,223.
- USPTO; Office Action dated Feb. 25, 2014 in U.S. Appl. No. 12/754,223.
- USPTO; Final Office Action dated Jul. 14, 2014 in U.S. Appl. No. 12/754,223.
- USPTO; Non-Final Office Action dated Mar. 25, 2015 in U.S. Appl. No. 12/754,223.
- USPTO; Final Office Action dated Aug. 12, 2015 in U.S. Appl. No. 12/754,223.
- USPTO; Notice of Allowance dated May 23, 2016 in U.S. Appl. No. 12/754,223.
- USPTO; Office Action dated Apr. 23, 2013 in U.S. Appl. No. 12/763,037.
- USPTO; Final Office Action dated Oct. 21, 2013 in U.S. Appl. No. 12/763,037.
- USPTO; Office Action dated Oct. 8, 2014 in U.S. Appl. No. 12/763,037.
- USPTO; Notice of Allowance dated Jan. 27, 2015 in U.S. Appl. No. 12/763,037.
- USPTO; Non-Final Office Action dated Jan. 24, 2011 in U.S. Appl. No. 12/778,808.
- USPTO; Notice of Allowance dated May 9, 2011 in U.S. Appl. No. 12/778,808.
- USPTO; Notice of Allowance dated Oct. 12, 2012 in U.S. Appl. No. 12/832,739.
- USPTO; Non-Final Office Action dated Oct. 16, 2012 in U.S. Appl. No. 12/847,848.
- USPTO; Final Office Action dated Apr. 22, 2013 in U.S. Appl. No. 12/847,848.
- USPTO; Advisory Action dated Jul. 1, 2013 in U.S. Appl. No. 12/847,848.
- USPTO; Notice of Allowance dated Jan. 16, 2014 in U.S. Appl. No. 12/847,848.
- USPTO; Office Action dated Dec. 6, 2012 in U.S. Appl. No. 12/854,818.
- USPTO; Final Office Action dated Mar. 13, 2013 in U.S. Appl. No. 12/854,818.
- USPTO; Office Action dated Aug. 30, 2013 in U.S. Appl. No. 12/854,818.
- USPTO; Final Office Action dated Mar. 26, 2014 in U.S. Appl. No. 12/854,818.
- USPTO; Office Action dated Jun. 3, 2014 in U.S. Appl. No. 12/854,818.
- USPTO; Non-Final Office Action dated Jul. 11, 2012 in U.S. Appl. No. 12/875,889.
- USPTO; Notice of Allowance dated Jan. 4, 2013 in U.S. Appl. No. 12/875,889.
- USPTO; Notice of Allowance dated Jan. 9, 2012 in U.S. Appl. No. 12/901,323.
- USPTO; Non-Final Office Action dated Nov. 20, 2013 in U.S. Appl. No. 12/910,607.
- USPTO; Final Office Action dated Apr. 28, 2014 in U.S. Appl. No. 12/910,607.
- USPTO; Advisory Action dated Jul. 9, 2014 in U.S. Appl. No. 12/910,607.
- USPTO; Notice of Allowance dated Aug. 15, 2014 in U.S. Appl. No. 12/910,607.
- USPTO; Non-Final Office Action dated Oct. 24, 2012 in U.S. Appl. No. 12/940,906.
- USPTO; Final Office Action dated Feb. 13, 2013 in U.S. Appl. No. 12/940,906.
- USPTO; Notice of Allowance dated Apr. 23, 2013 in U.S. Appl. No. 12/940,906.
- USPTO; Non-Final Office Action dated Dec. 7, 2012 in U.S. Appl. No. 12/953,870.

(56)

References Cited

OTHER PUBLICATIONS

USPTO; Final Office Action dated Apr. 22, 2013 in U.S. Appl. No. 12/953,870.
USPTO; Advisory Action dated Jul. 8, 2013 in U.S. Appl. No. 12/953,870.
USPTO; Non-Final Office Action dated Aug. 28, 2013 in U.S. Appl. No. 12/953,870.
USPTO; Final Office Action dated Apr. 17, 2014 in U.S. Appl. No. 12/953,870.
USPTO; Non-Final Office Action dated Sep. 19, 2012 in U.S. Appl. No. 13/016,735.
USPTO; Final Office Action dated Feb. 11, 2013 in U.S. Appl. No. 13/016,735.
USPTO; Notice of Allowance dated Apr. 24, 2013 in U.S. Appl. No. 13/016,735.
USPTO; Non-Final Office Action dated Apr. 4, 2012 in U.S. Appl. No. 13/030,438.
USPTO; Final Office Action dated Aug. 22, 2012 in U.S. Appl. No. 13/030,438.
USPTO; Notice of Allowance dated Oct. 24, 2012 in U.S. Appl. No. 13/030,438.
USPTO; Non-Final Office Action dated Dec. 3, 2012 in U.S. Appl. No. 13/040,013.
USPTO; Notice of Allowance dated May 3, 2013 in U.S. Appl. No. 13/040,013.
USPTO; Non-Final Office Action dated Feb. 15, 2012 in U.S. Appl. No. 13/085,531.
USPTO; Notice of Allowance dated Jul. 12, 2012 in U.S. Appl. No. 13/085,531.
USPTO; Notice of Allowance dated Sep. 13, 2012 in U.S. Appl. No. 13/085,698.
USPTO; Non-Final Office Action dated Mar. 29, 2013 in U.S. Appl. No. 13/094,402.
USPTO; Final Office Action dated Jul. 17, 2013 in U.S. Appl. No. 13/094,402.
USPTO; Notice of Allowance dated Sep. 30, 2013 in U.S. Appl. No. 13/094,402.
USPTO; Office Action dated Oct. 7, 2013 in U.S. Appl. No. 13/102,980.
USPTO; Final Office Action dated Mar. 25, 2014 in U.S. Appl. No. 13/102,980.
USPTO; Advisory Action dated Jun. 12, 2014 in U.S. Appl. No. 13/102,980.
USPTO; Notice of Allowance dated Jul. 3, 2014 in U.S. Appl. No. 13/102,980.
USPTO; Notice of Allowance dated Sep. 17, 2014 in U.S. Appl. No. 13/102,980.
USPTO; Non-Final Office Action dated Jul. 17, 2014 in U.S. Appl. No. 13/154,271.
USPTO; Final Office Action dated Jan. 2, 2015 in U.S. Appl. No. 13/154,271.
USPTO; Non-Final Office Action dated May 27, 2015 in U.S. Appl. No. 13/154,271.
USPTO; Final Office Action dated Nov. 23, 2015 in U.S. Appl. No. 13/154,271.
USPTO; Notice of Allowance dated Feb. 10, 2016 in U.S. Appl. No. 13/154,271.
USPTO; Non-Final Office Action dated Jun. 27, 2016 in U.S. Appl. No. 13/166,367.
USPTO; Final Office Action dated Dec. 30, 2016 in U.S. Appl. No. 13/166,367.
USPTO; Advisory Action dated Apr. 21, 2017 in U.S. Appl. No. 13/166,367.
USPTO; Notice of Allowance dated Jun. 28, 2017 in U.S. Appl. No. 13/166,367.
USPTO; Non-Final Office Action dated Oct. 27, 2014 in U.S. Appl. No. 13/169,951.
USPTO; Final Office Action dated May 26, 2015 in U.S. Appl. No. 13/169,951.

USPTO; Non-Final Office Action dated Sep. 1, 2015 in U.S. Appl. No. 13/169,951.
USPTO; Final Office Action dated Mar. 3, 2016 in U.S. Appl. No. 13/169,951.
USPTO; Non-Final Office Action dated Jun. 9, 2016 in U.S. Appl. No. 13/169,951.
USPTO; Final Office Action dated Dec. 9, 2016 in U.S. Appl. No. 13/169,951.
USPTO; Advisory Action dated May 13, 2016 in U.S. Appl. No. 13/169,951.
USPTO; Advisory Action dated Feb. 15, 2017 in U.S. Appl. No. 13/169,951.
USPTO; Non-Final Office Action dated Apr. 26, 2017 in U.S. Appl. No. 13/169,951.
USPTO; Final Office Action dated Nov. 2, 2017 in U.S. Appl. No. 13/169,951.
USPTO; Advisory Action dated Feb. 8, 2018 in U.S. Appl. No. 13/169,951.
USPTO; Non-Final Office Action dated Apr. 6, 2018 in U.S. Appl. No. 13/169,951.
USPTO; Final Office Action dated Nov. 2, 2018 in U.S. Appl. No. 13/169,951.
USPTO; Advisory Action dated Feb. 4, 2019 in U.S. Appl. No. 13/169,951.
USPTO; Notice of Allowance dated Apr. 4, 2019 in U.S. Appl. No. 13/169,951.
USPTO; Non-Final Office Action dated Jun. 24, 2014 in U.S. Appl. No. 13/181,407.
USPTO; Final Office Action dated Sep. 24, 2014 in U.S. Appl. No. 13/181,407.
USPTO; Advisory Action dated Dec. 17, 2014 in U.S. Appl. No. 13/181,407.
USPTO; Non-Final Office Action dated Jan. 2, 2015 in U.S. Appl. No. 13/181,407.
USPTO; Final Office Action dated Apr. 8, 2015 in U.S. Appl. No. 13/181,407.
USPTO; Non-Final Office Action dated Jan. 23, 2013 in U.S. Appl. No. 13/184,351.
USPTO; Final Office Action dated Jul. 29, 2013 in U.S. Appl. No. 13/184,351.
USPTO; Advisory Action dated Nov. 7, 2013 in U.S. Appl. No. 13/184,351.
USPTO; Non-Final Office Action dated Jul. 16, 2014 in U.S. Appl. No. 13/184,351.
USPTO; Final Office Action dated Feb. 17, 2015 in U.S. Appl. No. 13/184,351.
USPTO; Advisory Action dated May 18, 2015 in U.S. Appl. No. 13/184,351.
USPTO; Non-Final Office Action dated Aug. 10, 2015 in U.S. Appl. No. 13/184,351.
USPTO; Final Office Action dated Feb. 12, 2016 in U.S. Appl. No. 13/184,351.
USPTO; Non-Final Office Action dated Dec. 15, 2016 in U.S. Appl. No. 13/184,351.
USPTO; Final Office Action dated Jun. 15, 2017 in U.S. Appl. No. 13/184,351.
USPTO; Advisory Action dated Oct. 4, 2017 in U.S. Appl. No. 13/184,351.
USPTO; Non-Final Office Action dated Jul. 26, 2018 in U.S. Appl. No. 13/184,351.
USPTO; Final Office Action dated Dec. 28, 2018 in U.S. Appl. No. 13/184,351.
USPTO; Non-Final Office Action dated Sep. 17, 2014 in U.S. Appl. No. 13/187,300.
USPTO; Final Office Action dated Apr. 15, 2015 in U.S. Appl. No. 13/187,300.
USPTO; Non-Final Office Action dated Apr. 7, 2016 in U.S. Appl. No. 13/187,300.
USPTO; Final Office Action dated Sep. 23, 2016 in U.S. Appl. No. 13/187,300.
USPTO; Non-Final Office Action dated Jan. 30, 2017 in U.S. Appl. No. 13/187,300.

(56)

References Cited

OTHER PUBLICATIONS

- USPTO; Final Office Action dated Aug. 9, 2017 in Application No. 13/187,300.
- USPTO; Non-Final Office Action dated Oct. 1, 2012 in U.S. Appl. No. 13/191,762.
- USPTO; Final Office Action dated Apr. 10, 2013 in U.S. Appl. No. 13/191,762.
- USPTO; Notice of Allowance dated Aug. 15, 2013 in U.S. Appl. No. 13/191,762.
- USPTO; Non-Final Office Action dated Oct. 22, 2012 in U.S. Appl. No. 13/238,960.
- USPTO; Final Office Action dated May 3, 2013 in U.S. Appl. No. 13/238,960.
- USPTO; Non-Final Office Action dated Apr. 26, 2013 in U.S. Appl. No. 13/250,721.
- USPTO; Notice of Allowance dated Sep. 11, 2013 in U.S. Appl. No. 13/250,721.
- USPTO; Non-Final Office Action dated Jul. 2, 2014 in U.S. Appl. No. 13/283,408.
- USPTO; Final Office Action dated Jan. 29, 2015 in U.S. Appl. No. 13/283,408.
- USPTO; Non-Final Office Action dated Jun. 17, 2015 in U.S. Appl. No. 13/283,408.
- USPTO; Final Office Action dated Dec. 18, 2015 in U.S. Appl. No. 13/283,408.
- USPTO; Advisory Action dated Mar. 28, 2016 in U.S. Appl. No. 13/283,408.
- USPTO; Notice of Allowance dated Mar. 28, 2016 in U.S. Appl. No. 13/283,408.
- USPTO; Office Action dated Jul. 30, 2014 in U.S. Appl. No. 13/284,642.
- USPTO; Notice of Allowance dated Feb. 11, 2015 in U.S. Appl. No. 13/284,642.
- USPTO; Office Action dated Jan. 28, 2014 in U.S. Appl. No. 13/312,591.
- USPTO; Final Office Action dated May 14, 2014 in U.S. Appl. No. 13/312,591.
- USPTO; Advisory Action dated Aug. 26, 2014 in U.S. Appl. No. 13/312,591.
- USPTO; Non-Final Office Action dated Nov. 26, 2014 in U.S. Appl. No. 13/312,591.
- USPTO; Final Office Action dated Mar. 20, 2015 in U.S. Appl. No. 13/312,591.
- USPTO; Notice of Allowance dated May 14, 2015 in U.S. Appl. No. 13/312,591.
- USPTO; Notice of Allowance dated Jun. 11, 2015 in U.S. Appl. No. 13/312,591.
- USPTO; Non-Final Office Action dated Apr. 9, 2014 in U.S. Appl. No. 13/333,420.
- USPTO; Notice of Allowance dated Sep. 15, 2014 in U.S. Appl. No. 13/333,420.
- USPTO; Office Action dated Feb. 11, 2013 in U.S. Appl. No. 13/339,609.
- USPTO; Final Office Action dated May 17, 2013 in U.S. Appl. No. 13/339,609.
- USPTO; Office Action dated Aug. 29, 2013 in U.S. Appl. No. 13/339,609.
- USPTO; Final Office Action dated Dec. 18, 2013 in U.S. Appl. No. 13/339,609.
- USPTO; Notice of Allowance dated Apr. 7, 2014 in U.S. Appl. No. 13/339,609.
- USPTO; Non-Final Office Action dated Oct. 10, 2012 in U.S. Appl. No. 13/406,791.
- USPTO; Final Office Action dated Jan. 31, 2013 in U.S. Appl. No. 13/406,791.
- USPTO; Advisory Action dated Mar. 27, 2013 in U.S. Appl. No. 13/406,791.
- USPTO; Non-Final Office Action dated Apr. 25, 2013 in U.S. Appl. No. 13/406,791.
- USPTO; Final Office Action dated Aug. 23, 2013 in U.S. Appl. No. 13/406,791.
- USPTO; Advisory Action dated Oct. 29, 2013 in U.S. Appl. No. 13/406,791.
- USPTO; Non-Final Office Action dated Dec. 4, 2013 in U.S. Appl. No. 13/406,791.
- USPTO; Final Office Action dated Apr. 21, 2014 in U.S. Appl. No. 13/406,791.
- USPTO; Non-Final Office Action dated Jan. 14, 2013 in U.S. Appl. No. 13/410,970.
- USPTO; Notice of Allowance dated Feb. 14, 2013 in U.S. Appl. No. 13/410,970.
- USPTO; Non-Final Office Action dated Feb. 13, 2014 in U.S. Appl. No. 13/411,271.
- USPTO; Non-Final Office Action dated Jul. 31, 2014 in U.S. Appl. No. 13/411,271.
- USPTO; Advisory Action dated Apr. 22, 2015 in U.S. Appl. No. 13/411,271.
- USPTO; Final Office Action dated Jan. 16, 2015 in U.S. Appl. No. 13/411,271.
- USPTO; Notice of Allowance dated Oct. 6, 2015 in U.S. Appl. No. 13/411,271.
- USPTO; Office Action dated Feb. 4, 2014 in U.S. Appl. No. 13/439,528.
- USPTO; Final Office Action dated Jul. 8, 2014 in U.S. Appl. No. 13/439,528.
- USPTO; Notice of Allowance dated Oct. 21, 2014 in U.S. Appl. No. 13/439,528.
- USPTO; Non-Final Office Action dated Apr. 11, 2013 in U.S. Appl. No. 13/450,368.
- USPTO; Notice of Allowance dated Jul. 17, 2013 in U.S. Appl. No. 13/450,368.
- USPTO; Office Action dated May 23, 2013 in U.S. Appl. No. 13/465,340.
- USPTO; Final Office Action dated Oct. 30, 2013 in U.S. Appl. No. 13/465,340.
- USPTO; Notice of Allowance dated Feb. 12, 2014 in U.S. Appl. No. 13/465,340.
- USPTO; Non-Final Office Action dated Oct. 17, 2013 in U.S. Appl. No. 13/493,897.
- USPTO; Notice of Allowance dated Mar. 20, 2014 in U.S. Appl. No. 13/493,897.
- USPTO; Office Action dated Dec. 20, 2013 in U.S. Appl. No. 13/535,214.
- USPTO; Final Office Action dated Jun. 18, 2014 in U.S. Appl. No. 13/535,214.
- USPTO; Notice of Allowance dated Oct. 23, 2014 in U.S. Appl. No. 13/535,214.
- USPTO; Non-Final Office Action dated Sep. 11, 2013 in U.S. Appl. No. 13/550,419.
- USPTO; Final Office Action dated Jan. 27, 2014 in U.S. Appl. No. 13/550,419.
- USPTO; Advisory Action dated Mar. 31, 2014 in U.S. Appl. No. 13/550,419.
- USPTO; Notice of Allowance dated May 29, 2014 in U.S. Appl. No. 13/550,419.
- USPTO; Non-Final Office Action dated Aug. 8, 2014 in U.S. Appl. No. 13/563,066.
- USPTO; Final Office Action dated Feb. 12, 2015 in U.S. Appl. No. 13/563,066.
- USPTO; Advisory Action dated Apr. 16, 2015 in U.S. Appl. No. 13/563,066.
- USPTO; Notice of Allowance dated Jun. 12, 2015 in U.S. Appl. No. 13/563,066.
- USPTO; Notice of Allowance dated Jul. 16, 2015 in U.S. Appl. No. 13/563,066.
- USPTO; Non-Final Office Action dated May 28, 2013 in U.S. Appl. No. 13/563,274.
- USPTO; Notice of Allowance dated Sep. 27, 2013 in U.S. Appl. No. 13/563,274.
- USPTO; Non-Final Office Action dated Nov. 7, 2013 in U.S. Appl. No. 13/565,564.

(56)

References Cited

OTHER PUBLICATIONS

- USPTO; Final Office Action dated Feb. 28, 2014 in U.S. Appl. No. 13/565,564.
- USPTO; Advisory Action dated May 5, 2014 in U.S. Appl. No. 13/565,564.
- USPTO; Non-Final Office Action dated Jul. 2, 2014 in U.S. Appl. No. 13/565,564.
- USPTO; Notice of Allowance dated Nov. 3, 2014 in U.S. Appl. No. 13/565,564.
- USPTO; Notice of Allowance dated Sep. 13, 2013 in U.S. Appl. No. 13/566,069.
- USPTO; Non-Final Office Action dated Aug. 30, 2013 in U.S. Appl. No. 13/570,067.
- USPTO; Notice of Allowance dated Jan. 6, 2014 in U.S. Appl. No. 13/570,067.
- USPTO; Non-Final Office Action dated Oct. 15, 2014 in U.S. Appl. No. 13/597,043.
- USPTO; Final Office Action dated Mar. 13, 2015 in U.S. Appl. No. 13/597,043.
- USPTO; Notice of Allowance dated Aug. 28, 2015 in U.S. Appl. No. 13/597,043.
- USPTO; Non-Final Office Action dated Feb. 12, 2015 in U.S. Appl. No. 13/597,108.
- USPTO; Final Office Action dated Jun. 1, 2015 in U.S. Appl. No. 13/597,108.
- USPTO; Advisory Action dated Sep. 2, 2015 in U.S. Appl. No. 13/597,108.
- USPTO; Non-Final Office Action dated Dec. 8, 2015 in U.S. Appl. No. 13/597,108.
- USPTO; Final Office Action dated Jun. 2, 2016 in U.S. Appl. No. 13/597,108.
- USPTO; Non-Final Office Action dated Sep. 15, 2016 in U.S. Appl. No. 13/597,108.
- USPTO; Notice of Allowance dated Mar. 7, 2017 in U.S. Appl. No. 13/597,108.
- USPTO; Notice of Allowance dated Mar. 27, 2014 in U.S. Appl. No. 13/604,498.
- USPTO; Office Action dated Nov. 15, 2013 in U.S. Appl. No. 13/612,538.
- USPTO; Office Action dated Jul. 10, 2014 in U.S. Appl. No. 13/612,538.
- USPTO; Notice of Allowance dated Feb. 25, 2015 in U.S. Appl. No. 13/612,538.
- USPTO; Non-Final Office Action dated Apr. 15, 2015 in U.S. Appl. No. 13/646,403.
- USPTO; Final Office Action dated Oct. 15, 2015 in U.S. Appl. No. 13/646,403.
- USPTO; Notice of Allowance dated Feb. 2, 2016 in U.S. Appl. No. 13/646,403.
- USPTO; Non-Final Office Action dated May 15, 2014 in U.S. Appl. No. 13/646,471.
- USPTO; Final Office Action dated Aug. 18, 2014 in U.S. Appl. No. 13/646,471.
- USPTO; Advisory Action dated Nov. 14, 2014 in U.S. Appl. No. 13/646,471.
- USPTO; Non-Final Office Action dated Dec. 16, 2014 in U.S. Appl. No. 13/646,471.
- USPTO; Final Office Action dated Apr. 21, 2015 in U.S. Appl. No. 13/646,471.
- USPTO; Non-Final Office Action dated Aug. 19, 2015 in U.S. Appl. No. 13/646,471.
- USPTO; Final Office Action dated Jan. 22, 2016 in U.S. Appl. No. 13/646,471.
- USPTO; Advisory Action dated Apr. 15, 2016 in U.S. Appl. No. 13/646,471.
- USPTO; Non-Final Office Action dated Jun. 2, 2016 in U.S. Appl. No. 13/646,471.
- USPTO; Final Office Action dated Oct. 20, 2016 in U.S. Appl. No. 13/646,471.
- USPTO; Non-Final Office Action dated May 28, 2015 in U.S. Appl. No. 13/651,144.
- USPTO; Final Office Action dated Dec. 14, 2017 in U.S. Appl. No. 13/651,144.
- USPTO; Final Office Action dated Nov. 19, 2015 in U.S. Appl. No. 13/651,144.
- USPTO; Non-Final Office Action dated May 10, 2016 in U.S. Appl. No. 13/651,144.
- USPTO; Final Office Action dated Sep. 20, 2016 in U.S. Appl. No. 13/651,144.
- USPTO; Non-Final Office Action dated May 17, 2017 in U.S. Appl. No. 13/651,144.
- USPTO; Non-Final Office Action dated Dec. 14, 2017 in U.S. Appl. No. 13/651,144.
- USPTO; Advisory Action dated Apr. 19, 2018 in U.S. Appl. No. 13/651,144.
- USPTO; Non-Final Office Action dated Sep. 20, 2018 in U.S. Appl. No. 13/651,144.
- USPTO; Final Office Action dated Mar. 15, 2019 in U.S. Appl. No. 13/651,144.
- USPTO; Non-Final Office Action dated Nov. 19, 2015 in U.S. Appl. No. 14/659,437.
- USPTO; Final Office Action dated Mar. 17, 2016 in U.S. Appl. No. 14/659,437.
- USPTO; Notice of Allowance dated May 31, 2016 in U.S. Appl. No. 14/659,437.
- USPTO; Non-Final Office Action dated Jun. 18, 2015 in U.S. Appl. No. 13/665,366.
- USPTO; Final Office Action dated Mar. 1, 2016 in U.S. Appl. No. 13/665,366.
- USPTO; Advisory Action dated May 13, 2016 in U.S. Appl. No. 13/665,366.
- USPTO; Non-Final Office Action dated Jun. 17, 2016 in U.S. Appl. No. 13/665,366.
- USPTO; Final Office Action dated May 3, 2017 in U.S. Appl. No. 13/665,366.
- USPTO; Non-Final Office Action dated Apr. 3, 2015 in U.S. Appl. No. 13/677,133.
- USPTO; Notice of Allowance dated Aug. 4, 2015 in U.S. Appl. No. 13/677,133.
- USPTO; Notice of Allowance dated Aug. 24, 2015 in U.S. Appl. No. 13/677,133.
- USPTO; Office Action dated Jun. 2, 2014 in U.S. Appl. No. 13/677,151.
- USPTO; Final Office Action dated Nov. 14, 2014 in U.S. Appl. No. 13/677,151.
- USPTO; Notice of Allowance dated Feb. 26, 2015 in U.S. Appl. No. 13/677,151.
- USPTO; Notice of Allowance dated Mar. 17, 2015 in U.S. Appl. No. 13/677,151.
- USPTO; Non-Final Office Action dated Aug. 20, 2013 in U.S. Appl. No. 13/679,502.
- USPTO; Final Office Action dated Feb. 25, 2014 in U.S. Appl. No. 13/679,502.
- USPTO; Notice of Allowance dated May 2, 2014 in U.S. Appl. No. 13/679,502.
- USPTO; Non-Final Office Action dated Jul. 21, 2015 in U.S. Appl. No. 13/727,324.
- USPTO; Final Office Action dated Jan. 22, 2016 in U.S. Appl. No. 13/727,324.
- USPTO; Advisory Action dated Apr. 6, 2016 in U.S. Appl. No. 13/727,324.
- USPTO; Non-Final Office Action dated May 25, 2016 in U.S. Appl. No. 13/727,324.
- USPTO; Final Office Action dated Dec. 1, 2016 in U.S. Appl. No. 13/727,324.
- USPTO; Notice of Allowance dated Mar. 1, 2017 in U.S. Appl. No. 13/727,324.
- USPTO; Non-Final Office Action dated Oct. 24, 2013 in U.S. Appl. No. 13/749,878.
- USPTO; Non-Final Office Action dated Jun. 18, 2014 in U.S. Appl. No. 13/749,878.

(56)

References Cited

OTHER PUBLICATIONS

- USPTO; Final Office Action dated Dec. 10, 2014 in U.S. Appl. No. 13/749,878.
- USPTO; Notice of Allowance Mar. 13, 2015 dated in U.S. Appl. No. 13/749,878.
- USPTO; Non-Final Office Action dated Sep. 16, 2013 in U.S. Appl. No. 13/760,160.
- USPTO; Final Office Action dated Dec. 27, 2013 in U.S. Appl. No. 13/760,160.
- USPTO; Non-Final Office Action dated Jun. 4, 2014 in U.S. Appl. No. 13/760,160.
- USPTO; Final Office Action dated Sep. 25, 2014 in U.S. Appl. No. 13/760,160.
- USPTO; Final Office Action dated Jan. 28, 2015 in U.S. Appl. No. 13/760,160.
- USPTO; Final Office Action dated May 12, 2015 in U.S. Appl. No. 13/760,160.
- USPTO; Notice of Allowance dated Oct. 21, 2015 in U.S. Appl. No. 13/760,160.
- USPTO; Notice of Allowance dated Jan. 20, 2016 in U.S. Appl. No. 13/760,160.
- USPTO; Office Action dated Apr. 23, 2014 in U.S. Appl. No. 13/784,362.
- USPTO; Notice of Allowance dated Aug. 13, 2014 in U.S. Appl. No. 13/784,362.
- USPTO; Non-Final Office Action dated Dec. 19, 2013 in U.S. Appl. No. 13/784,388.
- USPTO; Notice of Allowance dated Jun. 4, 2014 in U.S. Appl. No. 13/784,388.
- USPTO; Non-Final Office Action dated Sep. 19, 2014 in U.S. Appl. No. 13/791,246.
- USPTO; Final Office Action dated Mar. 25, 2015 in U.S. Appl. No. 13/791,246.
- USPTO; Non-Final Office Action dated Oct. 26, 2015 in U.S. Appl. No. 13/791,246.
- USPTO; Final Office Action dated Apr. 20, 2016 in U.S. Appl. No. 13/791,246.
- USPTO; Advisory Action dated Jul. 13, 2016 in U.S. Appl. No. 13/791,246.
- USPTO; Non-Final Office Action dated Aug. 11, 2016 in U.S. Appl. No. 13/791,246.
- USPTO; Notice of Allowance dated Oct. 19, 2016 in U.S. Appl. No. 13/791,246.
- USPTO; Notice of Allowance dated Nov. 25, 2016 in U.S. Appl. No. 13/791,246.
- USPTO; Non-Final Office Action dated Nov. 6, 2015 in U.S. Appl. No. 13/791,339.
- USPTO; Final Office Action dated Apr. 12, 2016 in U.S. Appl. No. 13/791,339.
- USPTO; Advisory Action dated Jul. 14, 2016 in U.S. Appl. No. 13/791,339.
- USPTO; Notice of Allowance dated Aug. 24, 2016 in U.S. Appl. No. 13/791,339.
- USPTO; Non-Final Office Action dated Mar. 21, 2014 in U.S. Appl. No. 13/799,708.
- USPTO; Notice of Allowance dated Oct. 31, 2014 in U.S. Appl. No. 13/799,708.
- USPTO; Non-Final Office Action dated Sep. 1, 2016 in U.S. Appl. No. 14/827,177.
- USPTO; Non-Final Office Action dated Oct. 9, 2014 in U.S. Appl. No. 13/874,708.
- USPTO; Notice of Allowance dated Mar. 10, 2015 in U.S. Appl. No. 13/874,708.
- USPTO; Notice of Allowance dated Apr. 10, 2014 in U.S. Appl. No. 13/901,341.
- USPTO; Notice of Allowance dated Jun. 6, 2014 in U.S. Appl. No. 13/901,341.
- USPTO; Non-Final Office Action dated Jan. 2, 2015 in U.S. Appl. No. 13/901,372.
- USPTO; Final Office Action dated Apr. 16, 2015 in U.S. Appl. No. 13/901,372.
- USPTO; Notice of Allowance dated Aug. 5, 2015 in U.S. Appl. No. 13/901,372.
- USPTO; Advisory Action dated Jun. 29, 2015 in U.S. Appl. No. 13/901,372.
- USPTO; Non-Final Office Action dated Jul. 8, 2015 in U.S. Appl. No. 13/901,400.
- USPTO; Final Office Action dated Jan. 14, 2016 in U.S. Appl. No. 13/901,400.
- USPTO; Notice of Allowance dated Apr. 12, 2016 in U.S. Appl. No. 13/901,400.
- USPTO; Non-Final Office Action dated Apr. 24, 2014 in U.S. Appl. No. 13/912,666.
- USPTO; Final Office Action dated Sep. 25, 2014 in U.S. Appl. No. 13/912,666.
- USPTO; Advisory Action dated Dec. 11, 2014 in U.S. Appl. No. 13/912,666.
- USPTO; Non-Final Office Action dated Jan. 26, 2015 in U.S. Appl. No. 13/912,666.
- USPTO; Notice of Allowance dated Jun. 25, 2015 in U.S. Appl. No. 13/912,666.
- USPTO; Non-Final Office Action dated Dec. 16, 2014 in U.S. Appl. No. 13/915,732.
- USPTO; Final Office Action dated Apr. 10, 2015 in U.S. Appl. No. 13/915,732.
- USPTO; Notice of Allowance dated Jun. 19, 2015 in U.S. Appl. No. 13/915,732.
- USPTO; Notice of Allowance dated Mar. 17, 2015 in U.S. Appl. No. 13/923,197.
- USPTO; Non-Final Office Action dated Sep. 12, 2014 in U.S. Appl. No. 13/941,134.
- USPTO; Notice of Allowance dated Jan. 20, 2015 in U.S. Appl. No. 13/941,134.
- USPTO; Non-Final Office Action dated Jul. 30, 2015 in U.S. Appl. No. 13/941,216.
- USPTO; Final Office Action dated Mar. 1, 2016 in U.S. Appl. No. 13/941,216.
- USPTO; Non-Final Office Action dated Jun. 15, 2016 in U.S. Appl. No. 13/941,216.
- USPTO; Notice of Allowance dated Sep. 13, 2016 in U.S. Appl. No. 13/941,216.
- USPTO; Notice of Allowance dated Nov. 14, 2016 in U.S. Appl. No. 13/941,216.
- USPTO; Non-Final Office Action dated Jan. 14, 2014 in U.S. Appl. No. 13/941,226.
- USPTO; Non-Final Office Action dated Jul. 8, 2014 in U.S. Appl. No. 13/941,226.
- USPTO; Non-Final Office Action dated Feb. 3, 2015 in U.S. Appl. No. 13/941,226.
- USPTO; Final Office Action dated Feb. 12, 2016 in U.S. Appl. No. 13/941,226.
- USPTO; Advisory Action dated Jul. 29, 2016 in U.S. Appl. No. 13/941,226.
- USPTO; Non-Final Office Action dated Aug. 8, 2017 in U.S. Appl. No. 13/941,226.
- USPTO; Notice of Allowance dated Aug. 13, 2018 in U.S. Appl. No. 13/941,226.
- USPTO; Notice of Allowance dated Oct. 3, 2018 in U.S. Appl. No. 13/941,226.
- USPTO; Non-Final Office Action dated Oct. 30, 2014 in U.S. Appl. No. 13/948,055.
- USPTO; Notice of Allowance dated Feb. 27, 2015 in U.S. Appl. No. 13/948,055.
- USPTO; Notice of Allowance dated Mar. 31, 2015 in U.S. Appl. No. 13/948,055.
- USPTO; Non-Final Office Action dated Jun. 29, 2015 in U.S. Appl. No. 13/966,782.
- USPTO; Final Office Action dated Jan. 4, 2016 in U.S. Appl. No. 13/966,782.
- USPTO; Notice of Allowance dated Mar. 21, 2016 in U.S. Appl. No. 13/966,782.

(56)

References Cited

OTHER PUBLICATIONS

USPTO; Notice of Allowance dated Oct. 7, 2015 in U.S. Appl. No. 13/973,777.
USPTO; Non-Final Office Action dated Feb. 20, 2015 in U.S. Appl. No. 14/018,231.
USPTO; Notice of Allowance dated Jul. 20, 2015 in U.S. Appl. No. 14/018,231.
USPTO; Non-Final Office Action dated Apr. 7, 2015 in U.S. Appl. No. 14/018,345.
USPTO; Final Office Action dated Sep. 14, 2015 in U.S. Appl. No. 14/018,345.
USPTO; Notice of Allowance dated Jan. 14, 2016 in U.S. Appl. No. 14/018,345.
USPTO; Notice of Allowance dated Mar. 17, 2016 in U.S. Appl. No. 14/018,345.
USPTO; Non-Final Office Action dated Mar. 26, 2015 in U.S. Appl. No. 14/031,982.
USPTO; Final Office Action dated Aug. 28, 2015 in U.S. Appl. No. 14/031,982.
USPTO; Notice of Allowance dated Nov. 17, 2015 in U.S. Appl. No. 14/031,982.
USPTO; Non-Final Office Action dated Jan. 2, 2015 in U.S. Appl. No. 14/040,196.
USPTO; Non-Final Office Action dated Apr. 28, 2015 in U.S. Appl. No. 14/040,196.
USPTO; Notice of Allowance dated Sep. 11, 2015 in U.S. Appl. No. 14/040,196.
USPTO; Non-Final Action dated Dec. 3, 2015 in U.S. Appl. No. 14/050,150.
USPTO; Final Office Action dated Jun. 15, 2016 in U.S. Appl. No. 14/050,150.
USPTO; Final Office Action dated Jul. 8, 2016 in U.S. Appl. No. 14/050,150.
USPTO; Notice of Allowance dated Oct. 20, 2016 in U.S. Appl. No. 14/050,150.
USPTO; Non-Final Office Action dated Dec. 15, 2014 in U.S. Appl. No. 14/065,114.
USPTO; Final Office Action dated Jun. 19, 2015 in U.S. Appl. No. 14/065,114.
USPTO; Advisory Action dated Aug. 24, 2015 in U.S. Appl. No. 14/065,114.
USPTO; Non-Final Office Action dated Oct. 7, 2015 in U.S. Appl. No. 14/065,114.
USPTO; Notice of Allowance dated Feb. 22, 2016 in U.S. Appl. No. 14/065,114.
USPTO; Non-Final Office Action dated Nov. 14, 2014 in U.S. Appl. No. 14/069,244.
USPTO; Notice of Allowance dated Mar. 25, 2015 in U.S. Appl. No. 14/069,244.
USPTO; Non-Final Office Action dated Mar. 19, 2015 in U.S. Appl. No. 14/079,302.
USPTO; Final Office Action dated Sep. 1, 2015 in U.S. Appl. No. 14/079,302.
USPTO; Non-Final Office Action dated Dec. 23, 2015 in U.S. Appl. No. 14/079,302.
USPTO; Non-Final Office Action dated Apr. 27, 2016 in U.S. Appl. No. 14/079,302.
USPTO; Final Office Action dated Aug. 22, 2016 in U.S. Appl. No. 14/079,302.
USPTO; Notice of Allowance dated Dec. 14, 2016 in U.S. Appl. No. 14/079,302.
USPTO; Non-Final Office Action dated Sep. 9, 2015 in U.S. Appl. No. 14/090,750.
USPTO; Final Office Action dated Feb. 11, 2016 in U.S. Appl. No. 14/090,750.
USPTO; Advisory Action dated May 5, 2016 in U.S. Appl. No. 14/090,750.
USPTO; Non-Final Office Action dated Jun. 14, 2016 in U.S. Appl. No. 14/090,750.

USPTO; Advisory Action dated Dec. 21, 2016 in U.S. Appl. No. 14/090,750.
USPTO; Advisory Action dated Jan. 30, 2018 in U.S. Appl. No. 14/090,750.
USPTO; Final Office Action dated Sep. 28, 2016 in U.S. Appl. No. 14/090,750.
USPTO; Non-Final Office Action dated Jun. 23, 2017 in U.S. Appl. No. 14/090,750.
USPTO; Final Office Action dated Nov. 17, 2017 in U.S. Appl. No. 14/090,750.
USPTO; Non-Final Office Action dated Mar. 12, 2018 in U.S. Appl. No. 14/090,750.
USPTO; Notice of Allowance dated Aug. 29, 2018 in U.S. Appl. No. 14/090,750.
USPTO; Non-Final Office Action dated Mar. 19, 2015 in U.S. Appl. No. 14/166,462.
USPTO; Notice of Allowance dated Sep. 3, 2015 in U.S. Appl. No. 14/166,462.
USPTO; Non-Final Office Action dated Nov. 17, 2015 in U.S. Appl. No. 14/172,220.
USPTO; Office Action dated May 29, 2014 in U.S. Appl. No. 14/183,187.
USPTO; Final Office Action dated Nov. 7, 2014 in U.S. Appl. No. 14/183,187.
USPTO; Advisory Action dated Feb. 20, 2015 in U.S. Appl. No. 14/183,187.
USPTO; Non-Final Office Action dated Mar. 16, 2015 in U.S. Appl. No. 14/183,187.
USPTO; Final Office Action dated Jul. 10, 2015 in U.S. Appl. No. 14/183,187.
USPTO; Notice of Allowance dated Aug. 31, 2015 in U.S. Appl. No. 14/183,187.
USPTO; Non-Final Office Action dated Jan. 11, 2016 in U.S. Appl. No. 14/188,760.
USPTO; Final Office Action dated Aug. 25, 2016 in U.S. Appl. No. 14/188,760.
USPTO; Advisory Action dated Jan. 12, 2017 in U.S. Appl. No. 14/188,760.
USPTO; Non-Final Office Action dated Mar. 23, 2017 in U.S. Appl. No. 14/188,760.
USPTO; Final Office Action dated Oct. 5, 2017 in U.S. Appl. No. 14/188,760.
USPTO; Advisory Action dated Jan. 3, 2018 in U.S. Appl. No. 14/188,760.
USPTO; Non-Final Office Action dated Apr. 18, 2018 in U.S. Appl. No. 14/188,760.
USPTO; Final Office Action dated Jan. 25, 2019 in U.S. Appl. No. 14/188,760.
USPTO; Non-Final Office Action dated Oct. 8, 2015 in U.S. Appl. No. 14/218,374.
USPTO; Final Office Action dated Feb. 23, 2016 in U.S. Appl. No. 14/218,374.
USPTO; Advisory Action dated Apr. 29, 2016 in U.S. Appl. No. 14/218,374.
USPTO; Notice of Allowance dated Aug. 5, 2016 in U.S. Appl. No. 14/218,374.
USPTO; Non-Final Office Action dated Jul. 15, 2016 in U.S. Appl. No. 14/218,690.
USPTO; Final Office Action dated Nov. 14, 2016 in U.S. Appl. No. 14/218,690.
USPTO; Non-Final Office Action dated Apr. 6, 2017 in U.S. Appl. No. 14/218,690.
USPTO; Final Office Action dated Jul. 20, 2017 in U.S. Appl. No. 14/218,690.
USPTO; Non-Final Office Action dated Jan. 11, 2018 in U.S. Appl. No. 14/218,690.
USPTO; Final Office Action dated May 24, 2018 in U.S. Appl. No. 14/218,690.
USPTO; Notice of Allowance dated Sep. 24, 2018 in U.S. Appl. No. 14/218,690.
USPTO; Non-Final Office Action dated Sep. 22, 2015 in U.S. Appl. No. 14/219,839.

(56)

References Cited

OTHER PUBLICATIONS

- USPTO; Final Office Action dated Mar. 25, 2016 in U.S. Appl. No. 14/219,839.
- USPTO; Non-Final Office Action dated Dec. 22, 2016 in U.S. Appl. No. 14/219,839.
- USPTO; Advisory Action dated Jun. 30, 2016 in U.S. Appl. No. 14/219,839.
- USPTO; Final Office Action dated Jul. 6, 2017 in U.S. Appl. No. 14/219,839.
- USPTO; Non-Final Office Action dated Mar. 27, 2018 in U.S. Appl. No. 14/219,839.
- USPTO; Final Office Action dated Nov. 1, 2018 in U.S. Appl. No. 14/219,839.
- USPTO; Advisory Action dated Jan. 22, 2019 in U.S. Appl. No. 14/219,839.
- USPTO; Non-Final Office Action dated Jul. 15, 2019 in U.S. Appl. No. 14/219,839.
- USPTO; Non-Final Office Action dated Nov. 25, 2015 in U.S. Appl. No. 14/219,879.
- USPTO; Final Office action dated May 19, 2016 in U.S. Appl. No. 14/219,879.
- USPTO; Advisory Action dated Aug. 22, 2016 in U.S. Appl. No. 14/219,879.
- USPTO; Non-Final Office Action dated Dec. 23, 2016 in U.S. Appl. No. 14/219,879.
- USPTO; Final Office action dated Jul. 6, 2017 in U.S. Appl. No. 14/219,879.
- USPTO; Advisory Action dated Oct. 5, 2017 in U.S. Appl. No. 14/219,879.
- USPTO; Non-Final Office Action dated Apr. 6, 2018 in U.S. Appl. No. 14/219,879.
- USPTO; Final Office Action dated Nov. 2, 2018 in U.S. Appl. No. 14/219,879.
- USPTO; Advisory Action dated Jan. 22, 2019 in U.S. Appl. No. 14/219,879.
- USPTO; Non-Final Office Action dated Jun. 24, 2019 in U.S. Appl. No. 14/219,879.
- USPTO; Non-Final Office Action dated Sep. 18, 2015 in U.S. Appl. No. 14/244,689.
- USPTO; Notice of Allowance dated Feb. 11, 2016 in U.S. Appl. No. 14/244,689.
- USPTO; Non-Final Office Action dated Oct. 7, 2015 in U.S. Appl. No. 14/246,969.
- USPTO; Final Office Action dated May 4, 2016 in U.S. Appl. No. 14/246,969.
- USPTO; Advisory Action dated Aug. 2, 2016 in U.S. Appl. No. 14/246,969.
- USPTO; Non-Final Office Action dated Aug. 12, 2016 in U.S. Appl. No. 14/246,969.
- USPTO; Notice of Allowance dated Feb. 27, 2017 in U.S. Appl. No. 14/246,969.
- USPTO; Non-Final Office Action dated Nov. 20, 2015 in U.S. Appl. No. 14/260,701.
- USPTO; Notice of Allowance dated Jun. 2, 2016 in U.S. Appl. No. 14/260,701.
- USPTO; Notice of Allowance dated Feb. 23, 2016 in U.S. Appl. No. 14/327,134.
- USPTO; Non-Final Office Action dated Aug. 19, 2015 in U.S. Appl. No. 14/268,348.
- USPTO; Non-Final Office Action dated Jan. 6, 2016 in U.S. Appl. No. 14/268,348.
- USPTO; Final Office Action dated Apr. 29, 2016 in U.S. Appl. No. 14/268,348.
- USPTO; Notice of Allowance dated Aug. 30, 2016 in U.S. Appl. No. 14/268,348.
- USPTO; Non-Final Office Action dated Oct. 20, 2015 in U.S. Appl. No. 14/281,477.
- USPTO; Advisory Action dated Mar. 28, 2016 in U.S. Appl. No. 14/281,477.
- USPTO; Non-Final Office Action dated Jan. 13, 2017 in U.S. Appl. No. 14/444,744.
- USPTO; Final Office Action dated Jul. 10, 2017 in U.S. Appl. No. 14/444,744.
- USPTO; Non-Final Office Action dated Nov. 29, 2017 in U.S. Appl. No. 14/444,744.
- USPTO; Final Office Action dated Mar. 28, 2018 in U.S. Appl. No. 14/444,744.
- USPTO; Non-Final Office Action Dated Jul. 27, 2018 in U.S. Appl. No. 14/444,744.
- USPTO; Final Office Action dated Feb. 7, 2019 in U.S. Appl. No. 14/444,744.
- USPTO; Non-Final Office Action dated May 18, 2016 in U.S. Appl. No. 14/449,838.
- USPTO; Notice of Allowance dated Nov. 28, 2016 in U.S. Appl. No. 14/449,838.
- USPTO; Non-Final Office Action dated Feb. 12, 2015 in U.S. Appl. No. 14/457,058.
- USPTO; Final Office Action dated Jul. 14, 2015 in U.S. Appl. No. 14/457,058.
- USPTO; Non-Final Office Action dated Nov. 6, 2015 in U.S. Appl. No. 14/457,058.
- USPTO; Final Office Acton dated Jun. 17, 2016 in U.S. Appl. No. 14/457,058.
- USPTO; Advisory Action dated Sep. 21, 2016 in U.S. Appl. No. 14/457,058.
- USPTO; Non-Final Office Action dated Oct. 6, 2016 in U.S. Appl. No. 14/457,058.
- USPTO; Final Office Acton dated May 4, 2017 in U.S. Appl. No. 14/457,058.
- USPTO; Non-Final Office Action dated Oct. 19, 2017 in U.S. Appl. No. 14/457,058.
- USPTO; Final Office Action dated Jun. 14, 2018 in U.S. Appl. No. 14/457,058.
- USPTO; Non-Final Office Action dated Jan. 11, 2019 in U.S. Appl. No. 14/457,058.
- USPTO; Final Office Action dated Jun. 25, 2019 in U.S. Appl. No. 14/457,058.
- USPTO; Non-Final Office Action dated Sep. 16, 2016 in U.S. Appl. No. 14/465,252.
- USPTO; Final Office Action dated Nov. 1, 2016 in U.S. Appl. No. 14/465,252.
- USPTO; Non-Final Office Action dated Mar. 6, 2017 in U.S. Appl. No. 14/465,252.
- USPTO; Final Office Action dated Jun. 9, 2017 in U.S. Appl. No. 14/465,252.
- USPTO; Notice of Allowance dated Oct. 3, 2017 in U.S. Appl. No. 14/465,252.
- USPTO; Non-Final Office Action dated May 31, 2018 in U.S. Appl. No. 15/491,726.
- USPTO; Non-Final Office Action dated Nov. 24, 2015 in U.S. Appl. No. 14/498,036.
- USPTO; Final Office Action dated Apr. 5, 2016 in U.S. Appl. No. 14/498,036.
- USPTO; Advisory Action dated Jun. 16, 2016 in U.S. Appl. No. 14/498,036.
- USPTO; Notice of Allowance dated Aug. 17, 2016 in U.S. Appl. No. 14/498,036.
- USPTO; Non-Final Office Action dated Apr. 10, 2015 in U.S. Appl. No. 14/505,290.
- USPTO; Notice of Allowance dated Aug. 21, 2015 in U.S. Appl. No. 14/505,290.
- USPTO; Non-Final Office Action dated Dec. 17, 2015 in U.S. Appl. No. 14/508,296.
- USPTO; Final Office Action dated May 26, 2016 in U.S. Appl. No. 14/508,296.
- USPTO; Advisory Action dated Aug. 17, 2016 in U.S. Appl. No. 14/508,296.
- USPTO; Non-Final Office Action dated Sep. 8, 2016 in U.S. Appl. No. 14/508,296.
- USPTO; Final Office Action dated Dec. 7, 2016 in U.S. Appl. No. 14/508,296.

(56)

References Cited

OTHER PUBLICATIONS

- USPTO; Notice of Allowance dated Jan. 27, 2017 in U.S. Appl. No. 14/508,296.
- USPTO; Non-Final Office Action dated Apr. 6, 2017 in U.S. Appl. No. 14/508,489.
- USPTO; Final Office Action dated Oct. 4, 2017 in U.S. Appl. No. 14/508,489.
- USPTO; Non-Final Office Action dated May 15, 2018 in U.S. Appl. No. 14/508,489.
- USPTO; Final Office Action dated Nov. 28, 2018 in U.S. Appl. No. 14/508,489.
- USPTO; Non-Final Office Action dated Apr. 4, 2019 in U.S. Appl. No. 14/508,489.
- USPTO; Non-Final Office Action dated Jan. 16, 2015 in U.S. Appl. No. 14/563,044.
- USPTO; Final Office Action dated Jul. 16, 2015 in U.S. Appl. No. 14/563,044.
- USPTO; Notice of Allowance dated Oct. 15, 2015 in U.S. Appl. No. 14/563,044.
- USPTO; Notice of Allowance dated Dec. 2, 2015 in U.S. Appl. No. 14/563,044.
- USPTO; Non-Final Office Action dated May 4, 2016 in U.S. Appl. No. 14/568,647.
- USPTO; Final Office Action dated Sep. 29, 2016 in U.S. Appl. No. 14/568,647.
- USPTO; Advisory Action dated Dec. 21, 2016 in U.S. Appl. No. 14/568,647.
- USPTO; Non-Final Office Action dated Feb. 2, 2017 in U.S. Appl. No. 14/568,647.
- USPTO; Final Office Action dated May 19, 2017 in U.S. Appl. No. 14/568,647.
- USPTO; Non-Final Office Action dated Sep. 14, 2017 in U.S. Appl. No. 14/568,647.
- USPTO; Final Office Action dated Jan. 23, 2018 in U.S. Appl. No. 14/568,647.
- USPTO; Advisory Action dated Apr. 12, 2018 in U.S. Appl. No. 14/568,647.
- USPTO; Non-Final Office Action dated May 25, 2018 in U.S. Appl. No. 14/568,647.
- USPTO; Non-Final Office Action dated Oct. 1, 2015 in U.S. Appl. No. 14/571,126.
- USPTO; Final Office Action dated Feb. 22, 2016 in U.S. Appl. No. 14/571,126.
- USPTO; Notice of Allowance dated May 18, 2016 in U.S. Appl. No. 14/571,126.
- USPTO; Notice of Allowance dated Jun. 2, 2016 in U.S. Appl. No. 14/571,126.
- USPTO; Non-Final Office Action dated Nov. 25, 2015 in U.S. Appl. No. 14/598,532.
- USPTO; Notice of Allowance dated May 16, 2016 in U.S. Appl. No. 14/598,532.
- USPTO; Non-Final Office Action dated Jan. 15, 2016 in U.S. Appl. No. 14/606,364.
- USPTO; Final Office Action dated Jun. 14, 2016 in U.S. Appl. No. 14/606,364.
- USPTO; Advisory Action dated Aug. 25, 2016 in U.S. Appl. No. 14/606,364.
- USPTO; Non-Final Office Action dated Sep. 27, 2016 in U.S. Appl. No. 14/606,354.
- USPTO; Final Office Action dated Jan. 12, 2017 in U.S. Appl. No. 14/606,364.
- USPTO; Non-Final Office Action dated May 10, 2017 in U.S. Appl. No. 14/606,364.
- USPTO; Non-Final Office Action dated Mar. 3, 2016 in U.S. Appl. No. 14/622,603.
- USPTO; Notice of Allowance dated Aug. 2, 2016 in U.S. Appl. No. 14/622,603.
- USPTO; Notice of Allowance dated Feb. 16, 2016 in U.S. Appl. No. 14/634,342.
- USPTO; Non-Final Office Action dated Oct. 19, 2017 in U.S. Appl. No. 14/645,234.
- USPTO; Non-Final Office Action dated May 16, 2018 in U.S. Appl. No. 14/645,234.
- USPTO; Final Office Action dated Aug. 10, 2018 in U.S. Appl. No. 14/645,234.
- USPTO; Non-Final Office Action dated Jun. 7, 2017 in U.S. Appl. No. 14/656,588.
- USPTO; Final Office Action dated Dec. 26, 2017 in U.S. Appl. No. 14/656,588.
- USPTO; Non-Final Office Action dated Apr. 6, 2018 in U.S. Appl. No. 14/656,588.
- USPTO; Notice of Allowance dated Nov. 19, 2018 in U.S. Appl. No. 14/656,588.
- USPTO; Non-Final Office Action dated Mar. 21, 2016 in U.S. Appl. No. 14/659,152.
- USPTO; Final Office Action dated Jul. 29, 2016 in U.S. Appl. No. 14/659,152.
- USPTO; Notice of Allowance dated Nov. 22, 2016 in U.S. Appl. No. 14/659,152.
- USPTO; Non-Final Office Action dated Sep. 7, 2017 in U.S. Appl. No. 14/660,755.
- USPTO; Notice of Allowance dated Oct. 2, 2017 in U.S. Appl. No. 14/660,755.
- USPTO; Notice of Allowance dated Mar. 25, 2016 in U.S. Appl. No. 14/693,138.
- USPTO; Non-Final Office Action dated Aug. 3, 2017 in U.S. Appl. No. 14/752,712.
- USPTO; Final Office Action dated Nov. 29, 2017 in U.S. Appl. No. 14/752,712.
- USPTO; Advisory Action dated Feb. 15, 2018 in U.S. Appl. No. 14/752,712.
- USPTO; Non-Final Office Action dated Mar. 21, 2018 in U.S. Appl. No. 14/752,712.
- USPTO; Final Office Action dated Sep. 5, 2018 in U.S. Appl. No. 14/752,712.
- USPTO; Non-Final Office Action dated Dec. 28, 2018 in U.S. Appl. No. 14/752,712.
- USPTO; Notice of Allowance dated Jun. 11, 2019 in U.S. Appl. No. 14/752,712.
- USPTO; Non-Final Office Action dated Nov. 29, 2017 in U.S. Appl. No. 14/793,323.
- USPTO; Final Office Action dated Mar. 29, 2018 in U.S. Appl. No. 14/793,323.
- USPTO; Non-Final Office Action dated Aug. 10, 2018 in U.S. Appl. No. 14/793,323.
- USPTO; Final Office Action dated Feb. 25, 2019 in U.S. Appl. No. 14/793,323.
- USPTO; Non-Final Office Action dated Jun. 27, 2019 in U.S. Appl. No. 14/793,323.
- USPTO; Non-Final Office Action dated Jun. 16, 2017 in U.S. Appl. No. 14/798,136.
- USPTO; Notice of Allowance dated Oct. 5, 2017 in U.S. Appl. No. 14/798,136.
- USPTO; Non-Final Office Action dated Mar. 30, 2016 in U.S. Appl. No. 14/808,979.
- USPTO; Final Office Action dated Sep. 30, 2016 in U.S. Appl. No. 14/808,979.
- USPTO; Non-Final Office Action dated Dec. 20, 2016 in U.S. Appl. No. 14/808,979.
- USPTO; Final Office Action dated Jun. 8, 2017 in U.S. Appl. No. 14/808,979.
- USPTO; Non-Final Office Action dated Sep. 21, 2017 in U.S. Appl. No. 14/808,979.
- USPTO; Final Office Action dated Mar. 14, 2018 in U.S. Appl. No. 14/808,979.
- USPTO; Notice of Allowance dated Jun. 27, 2018 in U.S. Appl. No. 14/808,979.
- USPTO; Non-Final Office Action dated Feb. 23, 2018 in U.S. Appl. No. 14/817,953.
- USPTO; Notice of Allowance dated Jul. 11, 2018 in U.S. Appl. No. 14/817,953.

(56)

References Cited

OTHER PUBLICATIONS

USPTO; Notice of Allowance dated Jan. 27, 2017 in U.S. Appl. No. 14/827,177.
USPTO; Non-Final Office Action dated Sep. 9, 2016 in U.S. Appl. No. 14/829,565.
USPTO; Final Office Action dated Feb. 9, 2017 in U.S. Appl. No. 14/829,565.
USPTO; Advisory Action dated Apr. 20, 2017 in U.S. Appl. No. 14/829,565.
USPTO; Non-Final Office Action dated Sep. 19, 2017 in U.S. Appl. No. 14/829,565.
USPTO; Final Office Action dated Mar. 5, 2018 in U.S. Appl. No. 14/829,565.
USPTO; Advisory Action dated Aug. 10, 2018 in U.S. Appl. No. 14/829,565.
USPTO; Non-Final Office Action dated Sep. 6, 2018 in U.S. Appl. No. 14/829,565.
USPTO; Final Office Action dated Apr. 18, 2019 in U.S. Appl. No. 14/829,565.
USPTO; Advisory Action dated Jul. 22, 2019 in U.S. Appl. No. 14/829,565.
USPTO; Non-Final Office Action dated Apr. 29, 2016 in U.S. Appl. No. 14/835,637.
USPTO; Final Office Action dated Nov. 25, 2016 in U.S. Appl. No. 14/835,637.
USPTO; Advisory Action dated Feb. 14, 2017 in U.S. Appl. No. 14/835,637.
USPTO; Notice of Allowance dated Apr. 25, 2017 in U.S. Appl. No. 14/835,637.
USPTO; Non-Final Office Action dated Jul. 29, 2016 in U.S. Appl. No. 14/884,695.
USPTO; Final Office Action dated Feb. 9, 2017 in U.S. Appl. No. 14/884,695.
USPTO; Advisory Action dated Apr. 20, 2017 in U.S. Appl. No. 14/884,695.
USPTO; Non-Final Office Action dated May 18, 2017 in U.S. Appl. No. 14/884,695.
USPTO; Notice of Allowance dated Oct. 20, 2017 in U.S. Appl. No. 14/884,695.
USPTO; Non-Final Office Action dated May 18, 2017 in U.S. Appl. No. 14/886,571.
USPTO; Final Office Action dated Sep. 21, 2017 in U.S. Appl. No. 14/886,571.
USPTO; Notice of Allowance dated Dec. 6, 2017 in U.S. Appl. No. 14/886,571.
USPTO; Non-Final Office Action dated Dec. 1, 2016 in U.S. Appl. No. 14/919,536.
USPTO; Final Office Action dated Mar. 28, 2017 in U.S. Appl. No. 14/919,536.
USPTO; Non-Final Office Action dated Aug. 29, 2017 in U.S. Appl. No. 14/919,536.
USPTO; Final Office Action dated May 11, 2018 in U.S. Appl. No. 14/919,536.
USPTO; Notice of Allowance dated Oct. 4, 2018 in U.S. Appl. No. 14/919,536.
USPTO; Notice of Allowance dated Nov. 19, 2018 in U.S. Appl. No. 14/919,536.
USPTO; Non-Final Office Action dated May 3, 2016 in U.S. Appl. No. 14/937,053.
USPTO; Notice of Allowance dated Jul. 26, 2016 in U.S. Appl. No. 14/937,053.
USPTO; Non-Final Office Action dated Dec. 15, 2016 in U.S. Appl. No. 14/938,180.
USPTO; Notice of Allowance dated Nov. 9, 2017 in U.S. Appl. No. 14/938,180.
USPTO; Non-Final Office Action dated Apr. 14, 2017 in U.S. Appl. No. 14/956,115.
USPTO; Final Office Action dated Jul. 21, 2017 in U.S. Appl. No. 14/956,115.

USPTO; Notice of Allowance dated Dec. 14, 2017 in U.S. Appl. No. 14/956,115.
USPTO; Notice of Allowance dated Feb. 3, 2017 in U.S. Appl. No. 14/977,291.
USPTO; Non-Final Office Action dated Aug. 12, 2016 in U.S. Appl. No. 14/981,434.
USPTO; Notice of Allowance dated Nov. 21, 2016 in U.S. Appl. No. 14/981,434.
USPTO; Non-Final Office Action dated Jan. 12, 2017 in U.S. Appl. No. 14/981,468.
USPTO; Notice of Allowance dated Jun. 7, 2017 in U.S. Appl. No. 14/981,468.
USPTO; Non-Final Office Action dated Mar. 22, 2016 in U.S. Appl. No. 14/987,420.
USPTO; Non-Final Office Action dated Dec. 14, 2016 in U.S. Appl. No. 14/997,683.
USPTO; Final Office Action dated Apr. 14, 2017 in U.S. Appl. No. 14/997,683.
USPTO; Non-Final Office Action dated Sep. 1, 2017 in U.S. Appl. No. 14/997,683.
USPTO; Final Office Action dated Feb. 6, 2018 in U.S. Appl. No. 14/997,683.
USPTO; Advisory Action dated May 2, 2018 in U.S. Appl. No. 14/997,683.
USPTO; Non-Final Office Action dated Jun. 20, 2018 in U.S. Appl. No. 14/997,683.
USPTO; Final Office Action dated Dec. 10, 2018 in U.S. Appl. No. 14/997,683.
USPTO; Notice of Allowance dated Mar. 25, 2019 in U.S. Appl. No. 14/997,683.
USPTO; Non-Final Office Action dated Sep. 23, 2016 in U.S. Appl. No. 15/048,422.
USPTO; Notice of Allowance dated May 4, 2017 in U.S. Appl. No. 15/048,422.
USPTO; Non-Final Office Action dated Aug. 4, 2017 in U.S. Appl. No. 15/050,159.
USPTO; Notice of Allowance dated Feb. 7, 2018 in U.S. Appl. No. 15/050,159.
USPTO; Non-Final Office Action dated Apr. 22, 2016 in U.S. Appl. No. 15/055,122.
USPTO; Notice of Allowance dated Sep. 15, 2016 in U.S. Appl. No. 15/055,122.
USPTO; Non-Final Office Action dated Feb. 20, 2018 in U.S. Appl. No. 15/060,412.
USPTO; Final Office Action dated Oct. 19, 2018 in U.S. Appl. No. 15/060,412.
USPTO; Non-Final Office Action dated Jun. 3, 2019 in U.S. Appl. No. 15/060,412.
USPTO; Non-Final Office Action dated Aug. 27, 2018 in U.S. Appl. No. 15/067,028.
USPTO; Notice of Allowance dated Dec. 21, 2018 in U.S. Appl. No. 15/067,028.
USPTO; Non-Final Office Action dated Sep. 26, 2018 in U.S. Appl. No. 15/074,813.
USPTO; Notice of Allowance dated Feb. 25, 2019 in U.S. Appl. No. 15/074,813.
USPTO; Non-Final Office Action dated Jan. 9, 2018 in U.S. Appl. No. 15/135,224.
USPTO; Notice of Allowance dated Jun. 29, 2018 in U.S. Appl. No. 15/135,224.
USPTO; Non-Final Office Action dated Jan. 9, 2018 in U.S. Appl. No. 15/135,258.
USPTO; Final Office Action dated Jul. 6, 2018 in U.S. Appl. No. 15/135,258.
USPTO; Non-Final Office Action dated Nov. 23, 2018 in U.S. Appl. No. 15/135,258.
USPTO; Final Office Action dated Mar. 14, 2019 in U.S. Appl. No. 15/135,258.
USPTO; Non-Final Office Action dated Jul. 19, 2019 in U.S. Appl. No. 15/135,258.
USPTO; Non-Final Office Action dated Jan. 9, 2018 in U.S. Appl. No. 15/135,333.

(56)

References Cited

OTHER PUBLICATIONS

- USPTO; Notice of Allowance dated Sep. 14, 2018 in U.S. Appl. No. 15/135,333.
- USPTO; Non-Final Office Action dated Nov. 21, 2016 in U.S. Appl. No. 15/144,481.
- USPTO; Final Office Action dated May 26, 2017 in U.S. Appl. No. 15/144,481.
- USPTO; Non-Final Office Action dated Sep. 21, 2017 in U.S. Appl. No. 15/144,481.
- USPTO; Notice of Allowance dated Apr. 11, 2018 in U.S. Appl. No. 15/144,481.
- USPTO; Non-Final Office Action dated Apr. 13, 2017 in U.S. Appl. No. 15/144,506.
- USPTO; Final Office Action dated Oct. 10, 2017 in U.S. Appl. No. 15/144,506.
- USPTO; Final Office Action dated Jul. 26, 2018 in U.S. Appl. No. 15/144,506.
- USPTO; Notice of Allowance dated Mar. 13, 2019 in U.S. Appl. No. 15/144,506.
- USPTO; Non-Final Office Action dated Oct. 9, 2018 in U.S. Appl. No. 15/182,504.
- USPTO; Final Office Action dated Mar. 28, 2019 in U.S. Appl. No. 15/182,504.
- USPTO; Notice of Allowance dated Jul. 17, 2019 in U.S. Appl. No. 15/182,504.
- USPTO; Non-Final Office Action dated Nov. 28, 2016 in U.S. Appl. No. 15/203,632.
- USPTO; Final Office Action dated Jun. 7, 2017 in U.S. Appl. No. 15/203,632.
- USPTO; Advisory Action dated Aug. 23, 2017 in U.S. Appl. No. 15/203,632.
- USPTO; Notice of Allowance dated Sep. 20, 2017 in U.S. Appl. No. 15/203,632.
- USPTO; Non-Final Office Action dated Nov. 29, 2016 in U.S. Appl. No. 15/203,642.
- USPTO; Final Office Action dated Apr. 13, 2017 in U.S. Appl. No. 15/203,642.
- USPTO; Advisory Action dated Jun. 22, 2017 in U.S. Appl. No. 15/203,642.
- USPTO; Notice of Allowance dated Aug. 7, 2017 in U.S. Appl. No. 15/203,642.
- USPTO; Non-Final Office Action dated Jun. 1, 2017 in U.S. Appl. No. 15/205,827.
- USPTO; Final Office Action dated Oct. 16, 2017 in U.S. Appl. No. 15/205,827.
- USPTO; Non-Final Office Action dated May 14, 2018 in U.S. Appl. No. 15/205,827.
- USPTO; Final Office Action dated Oct. 9, 2018 in U.S. Appl. No. 15/205,827.
- USPTO; Non-Final Office Action dated Mar. 28, 2019 in U.S. Appl. No. 15/205,827.
- USPTO; Non-Final Office Action dated Mar. 31, 2017 in U.S. Appl. No. 15/205,890.
- USPTO; Notice of Allowance dated Oct. 16, 2017 in U.S. Appl. No. 15/205,890.
- USPTO; Non-Final Office Action dated Jan. 20, 2017 in U.S. Appl. No. 15/210,256.
- USPTO; Notice of Allowance dated May 18, 2017 in U.S. Appl. No. 15/210,256.
- USPTO; Notice of Allowance dated Jul. 24, 2017 in U.S. Appl. No. 15/210,256.
- USPTO; Non-Final Office Action dated Apr. 21, 2017 in U.S. Appl. No. 15/222,715.
- USPTO; Notice of Allowance dated Jul. 14, 2017 in U.S. Appl. No. 15/222,715.
- USPTO; Notice of Allowance dated Sep. 27, 2017 in U.S. Appl. No. 15/222,715.
- USPTO; Non-Final Office Action dated Feb. 3, 2017 in U.S. Appl. No. 15/222,738.
- USPTO; Notice of Allowance dated Feb. 3, 2017 in U.S. Appl. No. 15/222,738.
- USPTO; Notice of Allowance dated May 22, 2017 in U.S. Appl. No. 15/222,738.
- USPTO; Notice of Allowance dated Aug. 23, 2017 in U.S. Appl. No. 15/222,738.
- USPTO; Non-Final Office Action dated Jan. 17, 2017 in U.S. Appl. No. 15/222,749.
- USPTO; Final Office Action dated May 5, 2017 in U.S. Appl. No. 15/222,749.
- USPTO; Non-Final Office Action dated Sep. 7, 2017 in U.S. Appl. No. 15/222,749.
- USPTO; Final Office Action dated Jun. 4, 2018 in U.S. Appl. No. 15/222,749.
- USPTO; Notice of Allowance dated Aug. 30, 2018 in U.S. Appl. No. 15/222,749.
- USPTO; Non-Final Office Action dated Jan. 3, 2017 in U.S. Appl. No. 15/222,780.
- USPTO; Final Office Action dated May 5, 2017 in U.S. Appl. No. 15/222,780.
- USPTO; Non-Final Office Action dated Sep. 7, 2017 in U.S. Appl. No. 15/222,780.
- USPTO; Final Office Action dated May 17, 2018 in U.S. Appl. No. 15/222,780.
- USPTO; Non-Final Office Action dated Oct. 1, 2018 in U.S. Appl. No. 15/222,780.
- USPTO; Notice of Allowance dated Apr. 19, 2019 in U.S. Appl. No. 15/222,780.
- USPTO; Notice of Allowance dated Jul. 12, 2018 in U.S. Appl. No. 15/254,605.
- USPTO; Non-Final Office Action dated Aug. 28, 2017 in U.S. Appl. No. 15/254,724.
- USPTO; Notice of Allowance dated Jan. 17, 2018 in U.S. Appl. No. 15/254,724.
- USPTO; Notice of Allowance dated Apr. 2, 2018 in U.S. Appl. No. 15/254,724.
- USPTO; Non-Final Office Action dated May 22, 2018 in U.S. Appl. No. 15/262,990.
- USPTO; Non-Final Office Action dated Sep. 13, 2018 in U.S. Appl. No. 15/262,990.
- USPTO; Non-Final Office Action dated Jan. 30, 2019 in U.S. Appl. No. 15/262,990.
- USPTO; Final Office Action dated May 13, 2019 in U.S. Appl. No. 15/262,990.
- USPTO; Advisory Action dated Jul. 22, 2019 in U.S. Appl. No. 15/262,990.
- USPTO; Non-Final Office Action dated Aug. 3, 2018 in U.S. Appl. No. 15/273,488.
- USPTO; Final Office Action dated Jan. 11, 2019 in U.S. Appl. No. 15/273,488.
- USPTO; Notice of Allowance dated Apr. 19, 2019 in U.S. Appl. No. 15/273,488.
- USPTO; Non-Final Office Action dated Jul. 2, 2018 in U.S. Appl. No. 15/286,503.
- USPTO; Final Office Action dated Feb. 7, 2019 in U.S. Appl. No. 15/286,503.
- USPTO; Non-Final Office Action dated Jun. 27, 2019 in U.S. Appl. No. 15/286,503.
- USPTO; Non-Final Office Action dated Dec. 14, 2018 in U.S. Appl. No. 15/340,512.
- USPTO; Notice of Allowance dated May 24, 2019 in U.S. Appl. No. 15/340,512.
- USPTO; Non-Final Office Action dated Oct. 23, 2017 in U.S. Appl. No. 15/377,439.
- USPTO; Final Office Action dated Apr. 16, 2018 in U.S. Appl. No. 15/377,439.
- USPTO; Advisory Action dated Aug. 8, 2018 in U.S. Appl. No. 15/377,439.
- USPTO; Non-Final Office Action dated Nov. 14, 2018 in U.S. Appl. No. 15/377,439.
- USPTO; Final Office Action dated Jun. 25, 2019 in U.S. Appl. No. 15/377,439.

(56)

References Cited

OTHER PUBLICATIONS

- USPTO; Notice of Allowance dated Aug. 8, 2017 in U.S. Appl. No. 15/380,895.
- USPTO; Notice of Allowance dated Oct. 11, 2017 in U.S. Appl. No. 15/380,895.
- USPTO; Non-Final Office Action dated May 31, 2019 in U.S. Appl. No. 15/380,909.
- USPTO; Non-Final Office Action dated Jan. 4, 2018 in U.S. Appl. No. 15/380,921.
- USPTO; Final Office Action dated Jun. 28, 2018 in U.S. Appl. No. 15/380,921.
- USPTO; Non-Final Office Action dated Feb. 25, 2019 in U.S. Appl. No. 15/380,921.
- USPTO; Non-Final Office Action dated Oct. 3, 2017 in U.S. Appl. No. 15/388,410.
- USPTO; Final Office Action dated May 15, 2018 in U.S. Appl. No. 15/388,410.
- USPTO; Notice of Allowance dated Nov. 14, 2018 in U.S. Appl. No. 15/388,410.
- USPTO; Notice of Allowance dated Dec. 28, 2018 in U.S. Appl. No. 15/388,410.
- USPTO; Non-Final Office Action dated Aug. 11, 2017 in U.S. Appl. No. 15/397,237.
- USPTO; Notice of Allowance dated Dec. 22, 2017 in U.S. Appl. No. 15/397,237.
- USPTO; Non-Final Office Action dated Apr. 12, 2017 in U.S. Appl. No. 15/397,319.
- USPTO; Final Office Action dated Jul. 12, 2017 in U.S. Appl. No. 15/397,319.
- USPTO; Notice of Allowance dated Dec. 15, 2017 in U.S. Appl. No. 15/397,319.
- USPTO; Non-Final Office Action dated Feb. 5, 2019 in U.S. Appl. No. 15/402,993.
- USPTO; Final Office Action dated May 21, 2019 in U.S. Appl. No. 15/402,993.
- USPTO; Non-Final Office Action dated Sep. 20, 2018 in U.S. Appl. No. 15/410,503.
- USPTO; Final Office Action dated Feb. 4, 2019 in U.S. Appl. No. 15/410,503.
- USPTO; Non-Final Office Action dated Apr. 25, 2019 in U.S. Appl. No. 15/410,503.
- USPTO; Non-Final Office Action dated Aug. 7, 2018 in U.S. Appl. No. 15/428,808.
- USPTO; Final Office Action dated Jan. 11, 2019 in U.S. Appl. No. 15/428,808.
- USPTO; Notice of Allowance dated Apr. 25, 2019 in U.S. Appl. No. 15/428,808.
- USPTO; Non-Final Office Action dated Apr. 6, 2018 in U.S. Appl. No. 15/434,051.
- USPTO; Final Office Action dated Aug. 29, 2018 in U.S. Appl. No. 15/434,051.
- USPTO; Advisory Action dated Dec. 4, 2018 in U.S. Appl. No. 15/434,051.
- USPTO; Non-Final Office Action dated Jan. 25, 2019 in U.S. Appl. No. 15/434,051.
- USPTO; Notice of Allowance dated Jun. 3, 2019 in U.S. Appl. No. 15/434,051.
- USPTO; Notice of Allowance dated Oct. 6, 2017 in U.S. Appl. No. 15/450,199.
- USPTO; Non-Final Office Action dated Dec. 15, 2017 in U.S. Appl. No. 15/466,149.
- USPTO; Notice of Allowance dated Apr. 20, 2018 in U.S. Appl. No. 15/466,149.
- USPTO; Non-Final Office Action dated Apr. 6, 2018 in U.S. Appl. No. 15/472,750.
- USPTO; Notice of Allowance dated Nov. 30, 2018 in U.S. Appl. No. 15/472,750.
- USPTO; Non-Final Office Action dated Oct. 4, 2017 in U.S. Appl. No. 15/489,453.
- USPTO; Final Office Action dated Apr. 19, 2018 in U.S. Appl. No. 15/489,453.
- USPTO; Non-Final Office Action dated Sep. 10, 2018 in U.S. Appl. No. 15/489,453.
- USPTO; Final Office Action dated Feb. 27, 2019 in U.S. Appl. No. 15/489,453.
- USPTO; Non-Final Office Action dated Jun. 5, 2019 in U.S. Appl. No. 15/489,453.
- USPTO; Notice of Allowance dated Dec. 19, 2017 in U.S. Appl. No. 15/489,660.
- USPTO; Non-Final Office Action dated Dec. 6, 2017 in U.S. Appl. No. 15/476,035.
- USPTO; Notice of Allowance dated Mar. 21, 2018 in U.S. Appl. No. 15/476,035.
- USPTO; Notice of Allowance dated Aug. 14, 2018 in U.S. Appl. No. 15/476,035.
- USPTO; Final Office Action dated May 1, 2019 in U.S. Appl. No. 15/491,726.
- USPTO; Non-Final Office Action dated Jan. 16, 2018 in U.S. Appl. No. 15/499,647.
- USPTO; Notice of Allowance dated May 23, 2018 in U.S. Appl. No. 15/499,647.
- USPTO; Non-Final Office Action dated Jun. 21, 2018 in U.S. Appl. No. 15/499,647.
- USPTO; Notice of Allowance dated Nov. 1, 2018 in U.S. Appl. No. 15/499,647.
- USPTO; Notice of Allowance dated Nov. 15, 2018 in U.S. Appl. No. 15/499,647.
- USPTO; Office Action dated Aug. 30, 2018 in U.S. Appl. No. 15/589,849.
- USPTO; Final Office Action dated Mar. 6, 2019 in U.S. Appl. No. 15/589,849.
- USPTO; Non-Final Office Action dated Jun. 28, 2019 in U.S. Appl. No. 15/589,849.
- USPTO; Office Action dated May 3, 2018 in U.S. Appl. No. 15/589,861.
- USPTO; Non-Final Office Action dated Dec. 21, 2018 in U.S. Appl. No. 15/589,861.
- USPTO; Final Office Action dated Jun. 26, 2019 in U.S. Appl. No. 15/589,861.
- USPTO; Non-Final Office Action dated Apr. 4, 2018 in U.S. Appl. No. 15/592,730.
- USPTO; Final Office Action dated Nov. 16, 2018 in U.S. Appl. No. 15/592,730.
- USPTO; Advisory Action dated Mar. 15, 2019 in U.S. Appl. No. 15/592,730.
- USPTO; Non-Final Office Action dated Mar. 7, 2019 in U.S. Appl. No. 15/598,169.
- USPTO; Final Office Action dated Jun. 25, 2019 in U.S. Appl. No. 15/598,169.
- USPTO; Ex Parte Quayle Action dated Mar. 21, 2019 in U.S. Appl. No. 15/615,489.
- USPTO; Non-Final Office Action dated Feb. 1, 2019 in U.S. Appl. No. 15/627,189.
- USPTO; Notice of Allowance dated May 21, 2019 in U.S. Appl. No. 15/627,189.
- USPTO; Non-Final Office Action dated Nov. 9, 2018 in U.S. Appl. No. 15/636,307.
- USPTO; Final Office Action dated Mar. 6, 2019 in U.S. Appl. No. 15/636,307.
- USPTO; Non-Final Office Action dated Jul. 16, 2019 in U.S. Appl. No. 15/636,307.
- USPTO; Notice of Allowance dated Jul. 18, 2018 in U.S. Appl. No. 15/640,239.
- USPTO; Notice of Allowance dated Aug. 30, 2018 in U.S. Appl. No. 15/640,239.
- USPTO; Non-Final Office Action dated Jun. 5, 2018 in U.S. Appl. No. 15/650,686.
- USPTO; Final Office Action dated Nov. 20, 2018 in U.S. Appl. No. 15/650,686.
- USPTO; Notice of Allowance dated Jun. 24, 2019 in U.S. Appl. No. 15/650,686.

(56)

References Cited

OTHER PUBLICATIONS

- USPTO; Non-Final Office Action dated Sep. 21, 2018 in U.S. Appl. No. 15/659,631.
- USPTO; Notice of Allowance dated Feb. 21, 2019 in U.S. Appl. No. 15/659,631.
- USPTO; Non-Final Office Action dated Aug. 9, 2018 in U.S. Appl. No. 15/660,805.
- USPTO; Non-Final Office Action dated Mar. 1, 2019 in U.S. Appl. No. 15/660,805.
- USPTO; Non-Final Office Action dated Aug. 27, 2018 in U.S. Appl. No. 15/662,107.
- USPTO; Notice of Allowance dated Feb. 21, 2019 in U.S. Appl. No. 15/662,107.
- USPTO; Non-Final Office Action dated Dec. 4, 2018 in U.S. Appl. No. 15/672,063.
- USPTO; Notice of Allowance dated Mar. 20, 2019 in U.S. Appl. No. 15/672,063.
- USPTO; Non-Final Office Action dated Feb. 8, 2019 in U.S. Appl. No. 15/672,119.
- USPTO; Final Office Action dated Jul. 16, 2019 in U.S. Appl. No. 15/672,119.
- USPTO; Non-Final Office Action dated Jul. 27, 2018 in U.S. Appl. No. 15/673,110.
- USPTO; Notice of Allowance dated Jan. 9, 2019 in U.S. Appl. No. 15/673,110.
- USPTO; Non-Final Office Action dated Apr. 25, 2018 in U.S. Appl. No. 15/673,278.
- USPTO; Notice of Allowance dated May 6, 2019 in U.S. Appl. No. 15/673,278.
- USPTO; Non-Final Office Action dated Jan. 18, 2018 in U.S. Appl. No. 15/683,701.
- USPTO; Notice of Allowance dated Jan. 9, 2019 in U.S. Appl. No. 15/683,701.
- USPTO; Final Office Action dated Aug. 24, 2018 in U.S. Appl. No. 15/683,701.
- USPTO; Advisory Action dated Nov. 26, 2018 in U.S. Appl. No. 15/683,701.
- USPTO; Non-Final Office Action dated Dec. 18, 2018 in U.S. Appl. No. 15/690,017.
- USPTO; Non-Final Office Action dated Aug. 9, 2018 in U.S. Appl. No. 15/691,241.
- USPTO; Non-Final Office Action dated Mar. 19, 2019 in U.S. Appl. No. 15/691,241.
- USPTO; Final Office Action dated Jan. 11, 2019 in U.S. Appl. No. 15/691,241.
- USPTO; Non-Final Office Action dated Dec. 6, 2018 in U.S. Appl. No. 15/705,955.
- USPTO; Notice of Allowance dated Apr. 16, 2019 in U.S. Appl. No. 15/705,955.
- USPTO; Non-Final Office Action dated Feb. 11, 2019 in U.S. Appl. No. 15/707,786.
- USPTO; Non-Final Office Action dated Jun. 14, 2018 in U.S. Appl. No. 15/711,989.
- USPTO; Notice of Allowance dated Dec. 6, 2018 in U.S. Appl. No. 15/711,989.
- USPTO; Non-Final Office Action dated May 29, 2018 in U.S. Appl. No. 15/719,208.
- USPTO; Final Office Action dated Dec. 13, 2018 in U.S. Appl. No. 15/719,208.
- USPTO; Non-Final Office Action dated Jun. 25, 2019 in U.S. Appl. No. 15/719,208.
- USPTO; Non-Final Office Action dated Oct. 4, 2018 in U.S. Appl. No. 15/726,222.
- USPTO; Notice of Allowance dated Apr. 19, 2019 in U.S. Appl. No. 15/726,222.
- USPTO; Non-Final Office Action dated Apr. 19, 2018 in U.S. Appl. No. 15/726,959.
- USPTO; Final Office Action dated Nov. 14, 2018 in U.S. Appl. No. 15/726,959.
- USPTO; Non-Final Office Action dated May 17, 2018 in U.S. Appl. No. 15/729,485.
- USPTO; Notice of Allowance dated Jan. 23, 2019 in U.S. Appl. No. 15/729,485.
- USPTO; Non-Final Office Action dated Nov. 28, 2018 in U.S. Appl. No. 15/795,056.
- USPTO; Final Office Action dated Apr. 19, 2019 in U.S. Appl. No. 15/795,056.
- USPTO; Non-Final Office Action dated Jun. 26, 2018 in U.S. Appl. No. 15/796,593.
- USPTO; Final Office Action dated Feb. 21, 2019 in U.S. Appl. No. 15/796,593.
- USPTO; Non-Final Office Action dated Dec. 26, 2017 in U.S. Appl. No. 15/798,120.
- USPTO; Notice of Allowance dated Jun. 13, 2018 in U.S. Appl. No. 15/798,120.
- USPTO; Non-Final Office Action dated Dec. 21, 2018 in U.S. Appl. No. 15/798,150.
- USPTO; Notice of Allowance dated May 14, 2019 in U.S. Appl. No. 15/798,150.
- USPTO; Non-Final Office Action dated Aug. 9, 2018 in U.S. Appl. No. 15/798,201.
- USPTO; Final Office Action dated Dec. 14, 2018 in U.S. Appl. No. 15/798,201.
- USPTO; Non-Final Office Action dated Jul. 2, 2018 in U.S. Appl. No. 15/815,483.
- USPTO; Final Office Action dated Mar. 7, 2019 in U.S. Appl. No. 15/815,483.
- USPTO; Non-Final Office Action dated Sep. 26, 2018 in U.S. Appl. No. 15/832,188.
- USPTO; Notice of Allowance dated Dec. 5, 2017 in U.S. Appl. No. 15/832,188.
- USPTO; Non-Final Office Action dated Sep. 10, 2018 in U.S. Appl. No. 15/836,547.
- USPTO; Non-Final Office Action dated Mar. 13, 2019 in U.S. Appl. No. 15/836,547.
- USPTO; Non-Final Office Action dated Jul. 23, 2018 in U.S. Appl. No. 15/863,340.
- USPTO; Notice of Allowance dated Dec. 10, 2018 in U.S. Appl. No. 15/863,340.
- USPTO; Non-Final Office Action dated Jan. 11, 2019 in U.S. Appl. No. 15/879,209.
- USPTO; Non-Final Office Action dated Jan. 22, 2019 in U.S. Appl. No. 15/879,209.
- USPTO; Non-Final Office Action dated Apr. 17, 2019 in U.S. Appl. No. 15/886,225.
- USPTO; Non-Final Office Action dated Nov. 15, 2018 in U.S. Appl. No. 15/890,037.
- USPTO; Final Office Action dated May 2, 2019 in U.S. Appl. No. 15/890,037.
- USPTO; Notice of Allowance dated Feb. 8, 2019 in U.S. Appl. No. 15/892,756.
- USPTO; Non-Final Office Action dated Apr. 24, 2019 in U.S. Appl. No. 15/896,986.
- USPTO; Non-Final Office Action dated May 30, 2019 in U.S. Appl. No. 15/900,425.
- USPTO; Non-Final Office Action dated Mar. 8, 2019 in U.S. Appl. No. 15/917,224.
- USPTO; Non-Final Office Action dated Feb. 8, 2019 in U.S. Appl. No. 15/917,262.
- USPTO; Final Office Action dated Jun. 14, 2019 in U.S. Appl. No. 15/917,262.
- USPTO; Non-Final Office Action dated May 8, 2019 in U.S. Appl. No. 15/925,532.
- USPTO; Non-Final Office Action dated Mar. 29, 2019 in U.S. Appl. No. 15/940,801.
- USPTO; Notice of Allowance dated May 31, 2019 in U.S. Appl. No. 15/957,565.
- USPTO; Non-Final Office Action dated Apr. 19, 2019 in U.S. Appl. No. 15/985,298.
- USPTO; Non-Final Office Action dated Feb. 21, 2019 in U.S. Appl. No. 15/987,755.

(56)

References Cited

OTHER PUBLICATIONS

- USPTO; Non-Final Office Action dated Jul. 16, 2019 in U.S. Appl. No. 16/014,981.
- USPTO; Non-Final Office Action dated Jan. 24, 2019 in U.S. Appl. No. 16/018,692.
- USPTO; Notice of Allowance dated Apr. 9, 2019 in U.S. Appl. No. 16/026,711.
- USPTO; Non-Final Office Action dated Apr. 25, 2019 in U.S. Appl. No. 16/038,024.
- USPTO; Non-Final Office Action dated Apr. 2, 2019 in U.S. Appl. No. 16/147,047.
- USPTO; Notice of Allowance dated Apr. 17, 2019 in U.S. Appl. No. 16/171,098.
- USPTO; Notice of Allowance dated May 1, 2019 in U.S. Appl. No. 16/171,098.
- USPTO; Non-Final Office Action dated Apr. 2, 2019 in U.S. Appl. No. 16/188,690.
- USPTO; Notice of Allowance dated Jun. 13, 2019 in U.S. Appl. No. 16/396,475.
- USPTO; Notice of Allowance dated May 14, 2012 in U.S. Appl. No. 29/411,637.
- USPTO; Notice of Allowance dated Oct. 2, 2013 in U.S. Appl. No. 29/412,887.
- USPTO; Non-Final Office Action dated Mar. 16, 2015 in U.S. Appl. No. 29/447,298.
- USPTO; Notice of Allowance dated Jul. 6, 2015 in U.S. Appl. No. 29/447,298.
- USPTO; Notice of Allowance dated Dec. 19, 2013 in U.S. Appl. No. 29/448,094.
- USPTO; Notice of Allowance dated Nov. 26, 2014 in U.S. Appl. No. 29/481,301.
- USPTO; Notice of Allowance dated Feb. 17, 2015 in U.S. Appl. No. 29/481,308.
- USPTO; Notice of Allowance dated Jan. 12, 2015 in U.S. Appl. No. 29/481,312.
- USPTO; Notice of Allowance dated Apr. 30, 2015 in U.S. Appl. No. 29/481,315.
- USPTO; Notice of Allowance dated May 11, 2015 in U.S. Appl. No. 29/511,011.
- USPTO; Notice of Allowance dated May 11, 2015 in U.S. Appl. No. 29/514,153.
- USPTO; Notice of Allowance dated Dec. 14, 2015 in U.S. Appl. No. 29/514,264.
- USPTO; Notice of Allowance dated Jun. 16, 2017 in U.S. Appl. No. 29/570,711.
- USPTO; Non-Final Office Action dated Apr. 16, 2019 in U.S. Appl. No. 29/604,101.
- USPTO; Notice of Allowance dated Jun. 26, 2018 in U.S. Appl. No. 29/604,288.
- USPTO; Non-Final Office Action dated Feb. 20, 2019 in U.S. Appl. No. 29/646,377.
- WIPO; International Search Report and Written Opinion dated Nov. 16, 2017 in Application No. PCT/IB2017/001015.
- WIPO; International Search Report and Written Opinion dated Nov. 13, 2017 in Application No. PCT/IB2017/001050.
- WIPO; International Search Report and Written Opinion dated Nov. 30, 2017 in Application No. PCT/IB2017/001070.
- WIPO; International Search Report and Written Opinion dated Jan. 25, 2018 in Application No. PCT/IB2017/001262.
- WIPO; International Search Report and Written Opinion dated Sep. 14, 2018 in Application No. PCT/IB2017/001640.
- WIPO; International Search Report and Written Opinion dated Jun. 1, 2018 in Application No. PCT/IB2017/001644.
- WIPO; International Search Report and Written Opinion dated Nov. 6, 2018 in Application No. PCT/IB2017/001652.
- WIPO; International Search Report and Written Opinion dated Jun. 1, 2018 in Application No. PCT/IB2017/001656.
- WIPO; International Search Report and Written Opinion dated Jan. 25, 2019 in Application No. PCT/IB2018/000192.
- WIPO; International Search Report and Written Opinion dated Jul. 9, 2018 in Application No. PCT/IB2018/000419.
- WIPO; International Search Report and Written Opinion dated Jan. 4, 2019 in Application No. PCT/IB2018/000936.
- WIPO; International Search Report and Written Opinion dated Dec. 20, 2018 in Application No. PCT/IB2018/001003.
- WIPO; International Search Report and Written Opinion dated Dec. 20, 2018 in Application No. PCT/IB2018/001022.
- WIPO; International Search Report and Written Opinion dated May 23, 2019 in Application No. PCT/IB2019/050974.
- WIPO; International Preliminary Report on Patentability dated Nov. 24, 2009 and International Search Report dated Jul. 31, 2008 in Application No. PCT/US2008/063919.
- WIPO; International Preliminary Report on Patentability dated Feb. 24, 2010 in Application No. PCT/US2008/074063.
- WIPO; International Preliminary Report on Patentability dated Nov. 26, 2009 in Application No. PCT/US2009/043454.
- WIPO; International Preliminary Report on Patentability dated Jun. 14, 2011 in Application No. PCT/US2009/066377.
- WIPO; International Search report and Written Opinion dated Nov. 12, 2010 in Application No. PCT/US2010/030126.
- WIPO; International Preliminary Report on Patentability dated Oct. 11, 2011 Application No. PCT/US2010/030126.
- WIPO; International Preliminary Report on Patentability dated Nov. 9, 2011 in Application No. PCT/US2010/033244.
- WIPO; International Preliminary Report on Patentability dated Nov. 9, 2011 in Application No. PCT/US2010/033248.
- WIPO; International Preliminary Report on Patentability dated Nov. 9, 2011 in Application No. PCT/US2010/033252.
- WIPO; International Search report and Written Opinion dated Jan. 20, 2011 in Application No. PCT/US2010/045368.
- WIPO; International Search report and Written Opinion dated Feb. 6, 2013 in Application No. PCT/US2012/065343.
- WIPO; International Search report and Written Opinion dated Feb. 13, 2013 in Application No. PCT/US2012/065347.
- Arita et al. "Electrical and optical properties of germanium-doped zinc oxide thin films" *Materials Transactions*, vol. 45, No. 11, pp. 3180-3183 (2004).
- Arnold et al., "Novel single-layer vanadium sulphide phases" *2D Materials*, 5, 045009, 11 pages (2018).
- Athavale et al., "Realization of Atomic Layer Etching of Silicon", *Journal of Vacuum Science and Technology B*, vol. 14, pp. 3702-3705 (1996).
- Bearzotti, et al., "Fast Humidity Response of a Metal Halide-Doped Novel Polymer," *Sensors and Actuators B*, 7, pp. 451-454, (1992).
- Becker et al., "Atomic Layer Deposition of Insulating Hafnium and Zirconium Nitrides," *Chem. Mater.*, 16, 3497-3501 (2004).
- Beynet et al. "Low temperature plasma-enhanced ALD enables cost-effective spacer defined double patterning," *Proceedings of SPIE*, 7520, (2009).
- Bhatnagar et al., "Copper Interconnect Advances to Meet Moore's Law Milestones," *Solid State Technology*, 52, 10 (2009).
- Boscher et al., "Atmosphere Pressure Chemical Vapour Deposition of NbSe₂ Thin Films on Glass" *Eur. J. Inorg. Chem.*, pp. 1255-1259 (2006).
- Buriak, "Organometallic Chemistry on Silicon and Germanium Surfaces," *Chemical Reviews*, 102, 5 (2002).
- Cant et al., "Chemisorption Sites on Porous Silica Glass and on Mixed-Oxide Catalysis," *Can. J. Chem.* 46, 1373 (1968).
- Carmalt et al., "Chemical Vapor Deposition of Niobium Disulfide Thin Films" *Eur. J. Inorg. Chem.*, pp. 4470-4476 (2004).
- Casey et al. "Chemical Vapor Deposition of Mo onto Si" *J. Electrochem. Soc.: Solid State Science*, 114 (2), pp. 201-204 (1967).
- Chang et al. "Small-Subthreshold-Swing and Low-Voltage Flexible Organic Thin-Film Transistors Which Use HfLaO as the Gate Dielectric," *IEEE Electron Device Letters*, Feb. 2009, pp. 133-135; vol. 30, No. 2; IEEE Electron Device Society.
- Chatterjee et al., "Sub-100nm Gate Length Metal Gate NMOS Transistors Fabricated by a Replacement by a Replacement Gate Process," *IEEE Semiconductor Process and Device Center*, 821-824 (1997).

(56)

References Cited

OTHER PUBLICATIONS

- Chen et al., "A Self-Aligned Airgap Interconnect Scheme," IEEE International Interconnect Technology Conference, vol. 1-3, 146-148 (2009).
- Chen et al., "Develop Gap-fill Process of Shallow Trench Isolation in 450mm Wafer by Advanced Flowable CVD Technology for Sub-20nm Node," 2016 27th Annual Semi Advanced Semiconductor Manufacturing Conference (ASMC), IEEE, May 16, 2016, pp. 157-159 (2016).
- Cheng et al., "Effect of carrier gas on the structure and electric properties of low dielectric constant SiCOH film using trimethylsilane prepared by plasma enhanced chemical vapor deposition," Thin Solid Films vol. 469-470, pp. 178-183 (2004).
- Choi et al., "Improvement of Silicon Direct Bonding using Surfaces Activated by Hydrogen Plasma Treatment," Journal of the Korean Physical Society, 37, 6, 878-881 (2000).
- Choi et al., "Low Temperature Formation of Silicon Oxide Thin Films by Atomic Layer Deposition Using NH₃/O₂ Plasma," ECS Solid State Letters, 2(12) p. 114-p. 116 (2013).
- Coates, "Process Analytical Technology: Spectroscopic Tools and Implementation Strategies for the Chemical and Pharmaceutical Industries." Blackwell Publishing Ltd, 91-132, (2005).
- Conroy et al., "The Preparation and Properties of Single Crystals of the 1S and 2S Polymorphs of Tantalum Disulfide" J. Solid State Chemistry, 4, pp. 345-350 (1972).
- Crowell, "Chemical methods of thin film deposition: Chemical vapor deposition, atomic layer deposition, and related technologies," Journal of Vacuum Science & Technology A 21.5, (2003): S88-S95.
- Cui et al., "Impact of Reductive N₂/H₂ Plasma on Porous Low-Dielectric Constant SiCOH Thin Films," Journal of Applied Physics 97, 113302, 1-8 (2005).
- De Silva et al., "Inorganic Hardmask Development for Extreme Ultraviolet Patterning," Journal of Micro/Nanolithography, MEMS, and MOEMS 18(1) (2018).
- Dingemans et al., "Comparison Between Aluminum Oxide Surface Passivation Films Deposited with Thermal Aid," Plasma Aid and Pecvd, 35th IEEE PVCS, Jun. 2010.
- Drummond et al., "Hydrophobic Radiofrequency Plasma-Deposited Polymer Films: Dielectric Properties and Surface Forces," Colloids and Surfaces A, 129-130, 117-129 (2006).
- Duffey et al., "Raman Scattering from 1T-TaS₂" Solid State Communications 20, pp. 617-621 (1976).
- Easley et al., "Thermal Isolation of Microchip Reaction Chambers for Rapid Non-Contact DNA Amplification," J. Micromech. Microeng. 17, 1758-1766 (2007).
- Elam et al., "New Insights into Sequential Infiltration Synthesis", ECS Transactions, vol. 69, pp. 147-157 (2015).
- Elers et al. "Film Uniformity in Atomic Layer Deposition," Chemical Vapor Deposition, 12, pp. 13-24 (2006).
- Fu et al., "Controlled Synthesis of Atomically Thin 1T-TaS₂ for Tunable Charge Density Wave Phase Transitions" Chem. Mater. 28, pp. 7613-7618 (2016).
- Ge et al., "Carbon Nanotube-Based Synthetic Gecko Tapes," Department of Polymer Science, PNAS, 10792-10795 (2007).
- George et al., "Atomic Layer Deposition: An Overview," Chem. Rev. 110, 111-131 (2010).
- Gesheva et al. "Composition and Microstructure of Black Molybdenum Photothermal Converter Layers Deposited by the Pyrolytic Hydrogen Reduction of MoO₂Cl₂" Thin Solid Films, 79, pp. 39-49 (1981).
- Gole et al. "Preparation of Nickel Sulfide Thin Films and Nanocrystallites Using Nickel Furfuraldehyde Thiosemicarbazone as Single-source Precursor," Advanced Materials Research, vols. 383-390, pp. 3828-3834 (2012).
- Grill et al., "The Effect of Plasma Chemistry on the Damage Induced Porous SiCOH Dielectrics," IBM Research Division, RC23683 (W0508-008), Materials Science, 1-19 (2005).
- Guan et al., "Voltage gated ion and molecule transport in engineered nanochannels: theory, fabrication and applications," Nanotechnology 25 (2014) 122001.
- Gupta et al., "Charge carrier transport and electroluminescence in atomic layer deposited poly-GaN/c-Si heterojunction diodes," Journal of Applied Physics, 124, 084503 (2018).
- Gupta et al., "Conversion of Metal Carbides to Carbide Derived Carbon by Reactive Ion Etching in Halogen Gas," Proceedings of SPIE—The International Society for Optical Engineering and Nanotechnologies for Space Applications, ISSN: 0277-786X (2006).
- Habib et al. "Atmospheric oxygen plasma activation of silicon (100) surfaces," American Vacuum Society, 28(3), pp. 476-485 (2010).
- Han et al., "van der Waals Metallic Transition Metal Dichalcogenides" Chem. Rev. 118, pp. 6297-6336 (2018).
- Harrison et al., "Poly-gate Replacement Through Contact Hole (PRETCH): A New Method for High-K/ Metal Gate and Multi-Oxide Implementation on Chip," IEEE (2004).
- Heo et al., "Structural Characterization of Nanoporous Low-Dielectric Constant SiCOH Films Using Organosilane Precursors," NSTI-Nanotech, vol. 4, 122-123 (2007).
- Henke et al., "X-Ray Interactions: Photo absorption, Scattering, Transmission, and Reflection at E=50-30,000 eV, Z=1-92," Atomic Data and Nuclear Data Tables, 54, 181-342 (1993).
- Heyne et al., "The conversion mechanism of amorphous silicon to stoichiometric WS₂" J. Materials Chemistry C, 6, pp. 4122-4130 (2018).
- Hossain et al., "Recent Advances in Two-Dimensional Materials with Charge Density Waves: Synthesis, Characterization and Applications" Crystals 7, 298, 19 pages (2017).
- Hudis, "Surface Crosslinking of Polyethylene Using a Hydrogen Glow Discharge," J. Appl. Polym. Sci., 16 (1972) 2397
- Johansson et al. "Towards absolute asymmetric synthesis. Synthesis and crystal structure of stereochemically labile MCl₂ (M=Co, Ni, Cu, Zn) complexes with diamine ligands," Inorganica Chimica Acta 358, pp. 3293-3302 (2005).
- Jones et al., "Growth of Aluminum Films by Low Pressure Chemical Vapour Deposition Using Tertiarybutylaluminium," Journal of Crystal Growth 135, pp. 285-289, Elsevier Science B.V. (1994).
- Jones et al., "Recent Developments in Metalorganic Precursors for Metalorganic Chemical Vapour Deposition," Journal of Crystal Growth 146, pp. 503-510, Elsevier Science B.V. (1995).
- Jung et al., "Double Patterning of Contact Array with Carbon Polymer," Proc. of SPIE, 6924, 69240C, 1-10 (2008).
- Jung et al. "New Mechanisms for Ozone-Based ALO Growth of High-k Dielectrics via Nitrogen-Oxygen Species" ECS Transactions, 33(2), pp. 91-99 (2010).
- Kern et al., "Chemically Vapor-Deposited Borophosphosilicate Glasses for Silicon Device Applications" RCE Review, 43, 3, pp. 423-457 (1982).
- Kerrigan et al. "Low Temperature, Selective Atomic Layer Deposition of Cobalt Metal Films Using Bis(1,4-di-tert-butyl-1,3-diazadienyl)cobalt and Alkylamine Precursors," Chem. Materials, 29, pp. 7458-7466 (2017).
- Kim et al., "Passivation Effect on Low-k S/OC Dielectrics by H₂ Plasma Treatment," Journal of the Korean Physical Society, 40, 1, 94-98 (2002).
- Kim et al., "Characteristics of Low Temperature High Quality Silicon Oxide by Plasma Enhanced Atomic Layer Deposition with In-Situ Plasma Densification Process," The Electrochemical Society, ECS Transactions, College of Information and Communication Engineering, Sungkyunkwan University, 53(1), 321-329 (2013).
- Kim et al., "Novel Flowable CVD Process Technology for sub-20nm Interlayer Dielectrics," IEEE International Interconnect Technology Conference (IITC 2012), San Jose, California, USA, Jun. 4-6, 2012, pp. 1-3 (2012).
- King, Plasma Enhanced Atomic Layer Deposition of SiN_x: H and SiO₂, J. Vac. Sci. Technol., A29(4) (2011).
- Klug et al., "Atomic Layer Deposition of Amorphous Niobium Carbide-Based Thin Film Superconductors," The Journal of Physical Chemistry C, vol. 115, pp. 25063-25071, (2011).
- Kobayshi, et al., "Temperature Dependence of SiO₂ Film Growth with Plasma-Enhanced Atomic Layer Deposition," regarding Thin

(56)

References Cited

OTHER PUBLICATIONS

Solid Films, published by Elsevier in the International Journal on the Science and Technology of Condensed Matter, in vol. 520, No. 11, 3994-3998 (2012).

Kogelschatz et al. "Ozone Generation from Oxygen and Air: Discharge Physics and Reaction Mechanisms" *Ozone Science & Engineering*, 10, pp. 367-378 (1998).

Koo et al., "Characteristics of Al₂O₃ Thin Films Deposited Using Dimethylaluminum Isopropoxide and Trimethylaluminum Precursors by the Plasma-Enhanced Atomic-Layer Deposition Method," *Journal of Physical Society*, 48, 1, 131-136 (2006).

Koutsokeras et al. "Texture and Microstructure Evolution in Single-Phase TixTal-xN Alloys of Rocksalt Structure," *Journal of Applied Physics*, 110, pp. 043535-1-043535-6, (2011).

Knoops et al., "Atomic Layer Deposition of Silicon Nitride from Bis(tert-butyloamino) silane and N₂ Plasma," *Applied Materials & Interfaces*, American Chemical Society, A-E (2015).

Krennek et al. "IR Laser CVD of Nanodisperse Ge—Si—Sn Alloys Obtained by Dielectric Breakdown of GeH₄/SiH₄/SnH₄ Mixtures", *NanoCon 2014*, Nov. 5-7, Brno, Czech Republic, EU.

Kukli et al., "Influence of atomic layer deposition parameters on the phase content of Ta₂O₅ films" *J. Crystal Growth*, 212, pp. 459-468 (2000).

Kukli et al., "Properties of hafnium oxide films grown by atomic layer deposition from hafnium tetraiodide and oxygen". *Journal of Applied Physics*, vol. 92, No. 10, Nov. 15, 2002, pp. 5698-5703.

Kukli et al. "Properties of tantalum oxide thin films grown by atomic layer deposition" *Thin Solid Films*, 260, pp. 135-142 (1995).

Kurosawa et al., "Synthesis and Characterization of Plasma-Polymerized Hexamethyldisiloxane Films," *Thin Solid Films*, 506-507, 176-179 (2006).

Kwon et al., "Substrate Selectivity of (tBu-Allyl)Co(CO)₃ during Thermal Atomic Layer Deposition of Cobalt," *Chem. Materials*, 24, pp. 1025-1030 (2012).

Lanford et al., "The Hydrogen Content of Plasmadeposited Silicon Nitride," *J. Appl. Phys.*, 49, 2473 (1978).

Lee et al., "Characteristics of Low-K Sioc Films Deposited via Atomic Layer Deposition," *Thin Solid Films* 645, pp. 334-339 (2018).

Lee et al., Layer Selection by Multi-Level Permutation in 3-D Stacked NAND Flash Memory, *IEEE Electron Device Letters*, vol. 37, No. 7, 866-869 (2016).

Levy et al., "Reflow Mechanisms of Contact Vias in VLSI Processing" *J. Electrochem. Soc.: Solid-State Science and Technology*, 133, 7, pp. 1417-1424 (1986).

Li et al., "Metallic Transition-Metal Dichalcogenide Nanocatalysts for Energy Conversion" *Chem.* 4, pp. 1510-1537 (2018).

Liang et al. "Conversion of Metal Carbides to Carbide Derived Carbon by Reactive Ion Etching in Halogen Gas" *Micro (MEMS) and Nanotechnologies for Space Applications*, Thomas George et al. vol. 6223, 2006 p. 62230J-I to 62230J-11 lines 3-14 in the "Abstract" section and lines 7-9 in the "Introduction" section of p. 1, lines 3-4 in the "Introduction" section and lines 3-4 in the "Experimental Procedure" section of p. 2.

Lieberman, et al., "Principles of Plasma Discharges and Materials Processing," Second Edition, 368-381 (2005).

Lim et al., "Low-Temperature Growth of SiO₂ Films by Plasma-Enhanced Atomic Layer Deposition," *ETRI Journal*, 27 (1), 118-121 (2005).

Lim et al. "Synthesis and Characterization of Volatile, Thermally Stable, Reactive Transition Metal Amidinates," *Inorg. Chem.*, 42, pp. 7951-7958 (2003).

Liu et al., "Research, Design, and Experiment of End Effector for Wafer Transfer Robot," *Industrial Robot: An International Journal*, 79-91 (2012).

Liu et al., "Van der Waals metal-semiconductor junction: Weak Fermi level pinning enables effective tuning of Schottky barrier" *Sci. Adv.* 2: e1600069, 7 pages (2016).

Longrie et al., "Plasma-Enhanced ALD of Platinum with O₂, N₂ and NH₃ Plasmas", *ECS Journal of Solid State Science and Technology*, vol. 1, pp. Q123-Q129 (2012).

MacKenzie et al. "Stress Control of Si-Based PEVCD Dielectrics," *Proc. Symp. Silicon Nitride and Silicon Dioxide Thin Insulating Films & Other Emerging Dielectrics VIII*, 148-159 (2005).

Mackus et al., "Optical Emission Spectroscopy as a Tool for Studying Optimizing and Monitoring Plasma-Assisted Atomic Layer Deposition Processes," *Journal of Vacuum Science and Technology*, 77-87 (2010).

Maeno, "Gecko Tape Using Carbon Nanotubes," *Nitto Denko Gihou*, 47, 48-51 (2009).

Maeng et al. Electrical properties of atomic layer disposition HfO₂ and HfO_xNy on Si substrates with various crystal orientations, *Journal of the Electrochemical Society*, Apr. 2008, p. H267-H271, vol. 155, No. 4, Department of Materials Science and Engineering, Pohang University of Science and Technology, Pohang, Korea.

Makela et al. "Thermal Atomic Layer Deposition of Continuous and Highly Conducting Gold Thin Films," *Chem. Materials*, 29, pp. 6130-6136 (2017).

Marsik et al., "Effect of Ultraviolet Curing Wavelength on Low-k Dielectric Material Properties and Plasma Damage Resistance," *Sciencedirect.com*, 519, 11, 3619-3626 (2011).

Mason et al., "Hydrolysis of Tri-tert-butylaluminum: The First Structural Characterization of Alkylalumoxanes [(R₂Al)₂O]_n and (RAIO)_n," *J. American Chemical Society*, vol. 115, No. 12, pp. 4971-4984 (1993).

Massachusetts Institute of Technology Lincoln Laboratory, "Solid State Research," *Quarterly Technical Report* (1995).

Mattinen et al., "Crystalline tungsten sulfide thin films by atomic layer deposition and mild annealing" *J. Vac. Sci. Tech.* 37, 020921, 35 pages (2019).

Maydannik et al., "Spatial atomic layer deposition: Performance of low temperature H₂O and O₃oxidant chemistry for flexible electronics encapsulation", *Journal of Vacuum Science and Technology: Part A AVS/ AIP*, vol. 33 (1901).

Meng et al., "Atomic Layer of Deposition of Silicon Nitride Thin Films: A Review of Recent Progress, Challenges, and Outlooks," *Materials*, 9, 1007 (2016).

Mix et al., "Characterization of plasma-polymerized allyl alcohol polymers and copolymers with styrene," *Adhes. Sci. Technol.*, 21 (2007), S. 487-507.

Moeen, "Design, Modelling and Characterization of Si/SiGe Structures for IR Bolometer Applications," *KTH Royal Institute of Technology. Information and Communication Technology, Department of Integrated Devices and Circuits, Stockholm Sweden* (2015).

Morishige et al., "Thermal Desorption and Infrared Studies of Ammonia Amines and Pyridines Chemisorbed on Chromic Oxide," *J. Chem. Soc., Faraday Trans. 1*, 78, 2947-2957 (1982).

Mosleh et al., "Enhancement of Material Quality of (Si)GeSn Films Grown by SnCl₄ Precursor," *ECS Transactions*, 69 (5), 279-285 (2015).

Mukai et al., "A Study of CD Budget in Spacer Patterning Technology," *Proc. of SPIE*, 6924, 1-8 (2008).

Nakano et al., "Layer-by-Layer Epitaxial Growth of Scalable WSe₂ on Sapphire by Molecular Beam Epitaxy" *Nano. Lett.* 17, pp. 5595-5599 (2017).

Ngo et al. "Atomic layer deposition of photoactive CoO/SrTiO₃ and CoO/TiO₂ on Si(001) for visible light driven photoelectrochemical water oxidation," *J. Applied Physics*, 114, 9 pages (2013).

Nogueira et al., "Production of Highly Hydrophobic Films Using Low Frequency and High Density Plasma," *Revista Brasileira de Aplicacoes de Vacuo*, 25(1), 45-53 (2006).

Novaro et al. Theoretical Study on a Reaction Pathway of Ziegler-Natta-Type Catalysis, *J. Chem. Phys.* 68(5), Mar. 1, 1978 p. 2337-2351.

Ohchi et al. "Reducing damage to Si substrates during gate etching processes." *Japanese Journal of Applied Physics* 47.7R 5324 (2008).

Okamoto et al., "Luminescent Properties of Pr³⁺-sensitized LaPO₄: Gd³⁺ Ultraviolet-B Phosphor Under Vacuum-Ultraviolet Light Excitation," *J. App. Phys.* 106, 013522 (2009).

(56)

References Cited

OTHER PUBLICATIONS

- Park, "Substituted Aluminum Metal Gate on High-K Dielectric for Low Work-Function and Fermi-Level Pinning Free," 4 pages, IEEE 0-7803-8684-1/04 (2004).
- Portet et al., "Impact of Synthesis Conditions on Surface Chemistry and Structure of Carbide-Derived Carbons," *Thermochimica Acta*, 497, 137-142 (2010).
- Potts et al., "Low Temperature Plasma-Enhanced Atomic Layer Deposition of metal Oxide Thin Films," *Journal of the Electrochemical Society*, 157, 66-74 (2010).
- Potts et al., "Room-Temperature ALD of Metal Oxide Thin Films by Energy-Enhanced ALD", *Chemical Vapor Deposition*, vol. 19, pp. 125-133 (2013).
- Presser, et al., "Effect of Pore Size on Carbon Dioxide Sorption by Carbide Derived Carbon," *Energy & Environmental Science* 4.8, 3059-3066 (2011).
- Provine et al., "Correlation of Film Density and Wet Etch Rate in Hydrofluoric Acid of Plasma Enhanced Atomic Layer Deposited Silicon Nitride," *AIP Advances*, 6 (2016).
- Radamson et al. "Growth of Sn-alloyed Group IV Materials for Photonic and Electronic Applications" Chapter 5 pp. 129-144, *Manufacturing Nano Structures* (2014).
- Ryu et al., "Persistent Charge-Density-Wave Order in Single-Layer TaSe₂" *Nano. Lett.* 18, pp. 689-694 (2018).
- Sakuma et al., "Highly Scalable Horizontal Channel 3-D NAND Memory Excellent in Compatibility with Conventional Fabrication Technology," *IEEE Electron Device Letters*, vol. 34, No. 9, 1142-1144 (2013).
- Salim, "In-situ Fourier Transform Infrared Spectroscopy of Chemistry and Growth in Chemical Vapor Deposition," *Massachusetts Institute of Technology*, 187 pages (1995).
- Salim et al., "In Situ Concentration Monitoring in a Vertical OMVPE Reactor by Fiber-Optics-Based Fourier Transform Infrared Spectroscopy," *Journal of Crystal Growth* 169, pp. 443-449, Elsevier Science B.V. (1996).
- Samal et al., "Low-Temperature (<200° C.) Plasma Enhanced Atomic Deposition of Dense Titanium Nitride Thin Films" (2012).
- Sanders et al., "Crystalline and electronic structure of single-layer TaS₂" *Phys. Rev. B.* 94, 081404, 6 pages (2016).
- Schindler, Dissertation, Next Generation High-k Dielectrics for DRAM Produced by Atomic Layer Deposition Studied by Transmission Electron Microscopy (2015).
- Schmatz et al., "Unusual Isomerization Reactions in 1,3-Diaz-2-Silyclopentanes," *Organometallics*, 23, 1180-1182 (2004).
- Sellers, Making Your Own Timber Dogs, Paul Sellers blog, Published on Nov. 18, 2014, [online], [site visted Jun. 10, 2017]. Available from Internet, <URL: <https://paulsellers.com/2014/11/making-your-own-timber-dogs/>>.
- Selvaraj et al., "Selective Atomic Layer Deposition of Zirconia on Copper Patterned Silicon Substrates Using Ethanol as Oxygen Source as Well as Copper Reductant," *J. Vac. Sci. Technol.* A32(1), (2014).
- Selvaraj et al., "Surface Selective Atomic Layer Deposition of Hafnium Oxide for Copper Diffusion Barrier Application Using Tetrakis (diethylamino) Hafnium and Ethanol," 225th ECS Meeting, Meeting Abstract, (May 12, 2014).
- Seshadri et al., "Ultrathin Extreme Ultraviolet Patterning Stack Using Polymer Brush as an Adhesion Promotion Layer," *Journal of Micro/Nanolithography, MEMS, and MOEMS* 16(3) (2017).
- Shamma et al., "PDL Oxide Enabled Doubling," *Proc. of SPIE*, 6924, 69240D, 1-10 (2008).
- Simchi et al., "Sulfidation of 2D transition metals (Mo, W, Re, Nb, Ta): thermodynamics, processing, and characterization" *J. Materials Science* 52: 17, 9 pages (2017).
- Stanley et al. "Feedgas for Modern High-Performance Ozone Generators" Ozonia Ltd., Duebendorf, Switzerland. 7 pages. Available Jul. 14, 2017 online at: http://www.degremont-technologies.com/cms_medias/pdf/tech_ozonia_feedgas.pdf (1999).
- Svetin et al., "Three-dimensional resistivity and switching between correlated electronic states in 1T-TaS₂" *Nature, Scientific Reports* Apr. 12, 2017, 7:46048, 10 pages (2017).
- Tatehaha et al., "Adhesion Energy of Polystyrene and Substrate in Function Water," 5th International Symposium of Cleaning Technology in Semiconductor Device Manufacturing, pp. 560-565 (1998).
- Todi et al., "Characterization of Pt—Ru Binary Alloy Thin Films for Work Function Tuning," *IEEE Electron Device Letters*, vol. 27, No. 7, pp. 542-545 (2006).
- Tseng et al., "Etch Properties of Resists Modified by Sequential Infiltration Synthesis," *American Vacuum Society* (2011).
- Tseng et al., "Enhanced Block Copolymer Lithography Using Sequential Infiltration Synthesis," *Journal of Physical Chemistry*, vol. 5, 17725-17729 (2011).
- Ueda et al. "Enhanced Sidewall Grown (ESG) process: towards PEALD with conformality above 100%," *Extended Abstracts of the 2011 International Conference on Solid State Devices and Materials*, Nagoya, pp. 34-35 (2011).
- Varma, et al., "Effect of Metal Halides on Thermal, Mechanical, and Electrical Properties of Polypyromelitimide Films," *Journal of Applied Polymer Science*, vol. 32, pp. 3987-4000, (1986).
- Vasilev, "Borophosphosilicate Glass Films in Silicon Microelectronics, Part 1: Chemical Vapor Deposition, Composition, and Properties" *Russian Microelectronics*, vol. 33, No. 5, pp. 271-284 (2004).
- Voltaix, "Material Safety Data Sheet for: Trisilylamine", pp. 1-8, (2014).
- Wang et al., "Tertiarybutylaluminum as an Organometallic Source for Epitaxial Growth of AlGaSb," *Appl. Phys. Lett.* 67 (10), Sep. 4, pp. 1384-1386, American Institute of Physics (1995).
- Wirths, et al., "SiGeSn Growth studies Using Reduced Pressure Chemical Vapor Deposition Towards Optoelectronic Applications," *This Soid Films*, 557, 183-187 (2014).
- Xing et al., "Ising Superconductivity and Quantum Phase Transition in Macro-Size Monolayer NbSe₂" *Nano. Lett.* 17, pp. 6802-6807 (2017).
- Xu et al., "14NM Metal Gate Film Stack Development and Challenges," SMIC et al. (2016).
- Xu et al., "Contacts between Two- and Three-Dimensional Materials: Ohmic, Schottky, and p-n Heterojunctions" *ACS Nano* 10, pp. 4895-4919 (2016).
- Yoshida, et al., Threshold Voltage Tuning for 10NM and Beyond CMOS Integration, *Solid State Technology*, 57(7): 23-25 (2014).
- Yu et al., "Modulation of the Ni FUSI Workfunction by Yb Doping: from Midgap to N-Type Band-Edge," 4 pages, IEEE 0-7803-9269-8/05 (2005).
- Yuan et al., "Facile Synthesis of Single Crystal Vanadium Disulfide Nanosheets by Chemical Vapor Deposition for Efficient Hydrogen Evolution Reaction" *Adv. Mater.* 27, pp. 5605-5609 (2015).
- Yun et al., "Behavior of Various Organosilicon Molecules in PECVD Processes for Hydrocarbon-Doped Silicon Oxide Films," *Solid State Phenomena*, vol. 124-126, 347-350 (2007).
- Yun et al., "Comparison of Atomic Scale Etching of Poly-Si in Inductively Coupled Ar and He Plasmas", *Korean Journal of Chemical Engineering*, vol. 24, 670-673 (2007).
- Yun et al., "Single-Crystalline Si Stacked Array (STAR) NAND Flash Memory," *IEEE Transactions on Electron Devices*, vol. 58, No.4, 1006-1014 (2011).
- Yun et al., "Effect of Plasma on Characteristics of Zirconium Oxide Films Deposited by Plasma-Enhanced Atomic Layer Deposition," *Electrochemical and Solid State Letters*, 8(11) F47-F50 (2005).
- Yushin et al., "Carbon-Derived Carbon," Department of Materials Science and Engineering, Taylor & Francis Group, LLC (2006).
- Zhou et al., "A library of atomically thin metal chalcogenides" *Nature* 556, pp. 355-361 (2018).
- Chemistry Stack Exchange, "Why is CF₄ Non-Polar and CHF₃ Polar," <https://chemistry.stackexchange.com/questions/31604/why-is-cf4-non-polar-and-chf3-polar>, (2015).
- Crystal IS "Application Note: Using UV Reflective Materials to Maximize Disinfection"; AN011; Jun. 16, 2016.
- "Polyurethane_HF"; webpage; no date. Cited in Notice of References dated May 18, 2017 in U.S. Appl. No. 14/884,695.

(56)

References Cited

OTHER PUBLICATIONS

Scientific and Technical Information Center EIC 2800 Search Report dated Feb. 16, 2012.

CNIPA; Notice of Allowance dated Sep. 3, 2019 in Application No. 201610141027.1.

CNIPA; Notice of Allowance dated Sep. 30, 2010 in Application No. 201510765170.3.

CNIPA; Office Action dated Jul. 23, 2019 in Application No. 201610897958.4.

EPO; Notice of Allowance dated Aug. 1, 2019 in Application No. 09767208.3.

JPO; Office Action dated Aug. 29, 2019 in Application No. 2016001928.

KIPO; Notice of Allowance dated Jul. 5, 2019 in Application No. 10-2012-0064526.

KIPO; Notice of Allowance dated Aug. 29, 2019 in Application No. 10-2013-0036823.

KIPO; Office Action dated Aug. 27, 2019 in Application No. 10-2013-0049598.

KIPO; Office Action dated Aug. 27, 2019 in Application No. 10-2013-0089998.

KIPO; Notice of Allowance dated Oct. 8, 2019 in Application No. 10-2013-0101944.

KIPO; Office Action dated Aug. 15, 2019 in Application No. 10-2013-0109390.

KIPO; Office Action dated Oct. 7, 2019 in Application No. 10-2013-0114079.

KIPO; Notice of Allowance dated Aug. 26, 2019 in Application No. 10-2014-7017110.

KIPO; Final Office Action dated Jun. 17, 2019 in Application No. 10-2017-7023740.

TIPO; Office Action dated Aug. 16, 2019 in Application No. 102136496.

TIPO; Notice of Allowance dated Jul. 10, 2019 in Application No. 103123439.

TIPO; Notice of Allowance dated Sep. 27, 2019 in Application No. 104105533.

TIPO; Notice of Allowance dated Sep. 23, 2019 in Application No. 104105965.

TIPO; Notice of Allowance dated Oct. 4, 2019 in Application No. 104122889.

TIPO; Notice of Allowance dated Jul. 19, 2019 in Application No. 104122890.

TIPO; Office Action dated Jul. 5, 2019 in Application No. 105112363.

TIPO; Office Action dated Sep. 9, 2019 in Application No. 105115513.

TIPO; Notice of Allowance dated Sep. 20, 2019 in Application No. 106138800.

TIPO; Office Action dated Aug. 27, 2019 in Application No. 107116804.

TIPO; Office Action dated Jun. 28, 2019 in Application No. 108102948.

USPTO; Non-Final Office Action dated Aug. 19, 2019 in U.S. Appl. No. 13/184,351.

USPTO; Advisory Action dated Feb. 12, 2016 in U.S. Appl. No. 13/651,144.

USPTO; Advisory Action dated Dec. 29, 2016 in U.S. Appl. No. 13/651,144.

USPTO; Non-Final Office Action dated Sep. 18, 2019 in U.S. Appl. No. 13/651,144.

USPTO; Advisory Action dated Jun. 26, 2015 in U.S. Appl. No. 13/791,246.

USPTO; Notice of Allowance dated Apr. 22, 2016 in U.S. Appl. No. 14/172,220.

USPTO; Non-Final Office Action dated Aug. 8, 2019 in U.S. Appl. No. 14/188,760.

USPTO; Notice of Allowance dated Aug. 19, 2016 in U.S. Appl. No. 14/268,348.

USPTO; Non-Final Office Action dated Aug. 8, 2019 in U.S. Appl. No. 14/444,744.

USPTO; Advisory Action dated Nov. 6, 2015 in U.S. Appl. No. 14/457,058.

USPTO; Notice of Allowance dated Aug. 16, 2017 in U.S. Appl. No. 14/606,364.

USPTO; Notice of Allowance dated Aug. 15, 2019 in U.S. Appl. No. 14/645,234.

USPTO; Non-Final Office Action dated Sep. 19, 2019 in U.S. Appl. No. 14/829,565.

USPTO; Final Office Action dated Jun. 10, 2016 in U.S. Appl. No. 14/987,420.

USPTO; Notice of Allowance dated Mar. 26, 2018 in U.S. Appl. No. 15/144,481.

USPTO; Final Office Action dated Aug. 9, 2019 in U.S. Appl. No. 15/205,827.

USPTO; Non-Final Office Action dated Aug. 5, 2019 in U.S. Appl. No. 15/262,990.

USPTO; Advisory Action dated Jul. 29, 2019 in U.S. Appl. No. 15/402,993.

USPTO; Notice of Allowance dated Aug. 14, 2019 in U.S. Appl. No. 15/410,503.

USPTO; Final Office Action dated Aug. 20, 2019 in U.S. Appl. No. 14/508,489.

USPTO; Notice of Allowance dated Aug. 21, 2019 in U.S. Appl. No. 15/592,730.

USPTO; Notice of Allowance dated Sep. 11, 2019 in U.S. Appl. No. 15/598,169.

USPTO; Non-Final Office Action dated Sep. 4, 2019 in U.S. Appl. No. 15/615,489.

USPTO; Non-Final Office Action dated Jul. 29, 2019 in U.S. Appl. No. 15/660,797.

USPTO; Notice of Allowance dated Aug. 22, 2019 in U.S. Appl. No. 15/660,805.

USPTO; Final Office Action dated Jul. 26, 2019 in U.S. Appl. No. 15/690,017.

USPTO; Final Office Action dated Aug. 12, 2019 in U.S. Appl. No. 15/707,786.

USPTO; Non-Final Office Action dated Jul. 8, 2019 in U.S. Appl. No. 15/726,959.

USPTO; Final Office Action dated Jul. 31, 2019 in U.S. Appl. No. 15/795,056.

USPTO; Non-Final Office Action dated Oct. 2, 2019 in U.S. Appl. No. 15/798,201.

USPTO; Non-Final Office Action dated Aug. 20, 2019 in U.S. Appl. No. 15/815,483.

USPTO; Notice of Allowance dated Aug. 16, 2019 in U.S. Appl. No. 15/836,547.

USPTO; Non-Final Office Action dated Jul. 31, 2019 in U.S. Appl. No. 15/860,564.

USPTO; Final Office Action dated Aug. 21, 2019 in U.S. Appl. No. 15/879,209.

USPTO; Notice of Allowance dated Sep. 23, 2019 in U.S. Appl. No. 15/886,225.

USPTO; Non-Final Office Action dated Sep. 19, 2019 in U.S. Appl. No. 15/897,578.

USPTO; Final Office Action dated Aug. 28, 2019 in U.S. Appl. No. 15/917,224.

USPTO; Notice of Allowance dated Aug. 30, 2019 in U.S. Appl. No. 15/917,262.

USPTO; Non-Final Office Action dated Jul. 22, 2019 in U.S. Appl. No. 15/940,759.

USPTO; Notice of Allowance dated Aug. 26, 2019 in U.S. Appl. No. 15/940,801.

USPTO; Notice of Allowance dated Aug. 22, 2019 in U.S. Appl. No. 15/985,298.

USPTO; Notice of Allowance dated Jul. 31, 2019 in U.S. Appl. No. 15/987,755.

USPTO; Non-Final Office Action dated Jul. 29, 2019 in U.S. Appl. No. 16/000,125.

USPTO; Final Office Action dated Aug. 23, 2019 in U.S. Appl. No. 16/018,692.

USPTO; Non-Final Office Action dated Aug. 7, 2019 in U.S. Appl. No. 16/024,390.

USPTO; Notice of Allowance dated Jul. 10, 2019 in U.S. Appl. No. 16/046,218.

(56)

References Cited

OTHER PUBLICATIONS

- USPTO; Final Office Action dated Sep. 25, 2019 in U.S. Appl. No. 16/147,047.
- USPTO; Non-Final Office Action dated Aug. 6, 2019 in U.S. Appl. No. 16/158,077.
- USPTO; Final Office Action dated Sep. 26, 2019 in U.S. Appl. No. 16/188,690.
- USPTO; Non-Final Office Action dated Aug. 29, 2019 in U.S. Appl. No. 16/161,744.
- USPTO; Non-Final Office Action dated Aug. 16, 2019 in U.S. Appl. No. 16/167,225.
- USPTO; Non-Final Office Action dated Aug. 19, 2019 in U.S. Appl. No. 16/208,062.
- USPTO; Non-Final Office Action dated Sep. 16, 2019 in U.S. Appl. No. 16/213,702.
- USPTO; Non-Final Office Action dated Aug. 21, 2019 in U.S. Appl. No. 29/634,768.
- WIPO; International Search Report and Written Opinion dated Jun. 28, 2019 in Application No. PCT/IB2019/000084.
- Bark et al. "Large-area niobium disulfide thin films as transparent electrodes for devices based on two-dimensional materials," *Nanoscale*, published online, 7 pages (2012).
- Barreca et al. "Cobalt oxide nanomaterials by vapor phase synthesis for fast and reversible lithium storage" *J Phys Chem C*, 114, 10054-10060 (2010).
- Basuvalingam et al. "NS-WeA6—Low Temperature ALD for Phase-controlled Synthesis of 2D Transition Metal (M=Ti, Nb) di-(MX₂) and Tri-(MX₃) Sulfides," AVS 19th International Conference on Atomic Layer Deposition (ALD 2019), Jul. 22, 2019, Abstract, 1 page (2019).
- Cahiez et al. "Cobalt-Catalyzed cross coupling reaction between functionalized primary and secondary alkyl halides and aliphatic grignard reagents" *Adv. Synth. Catal.* 350, 1484-1488 (2008).
- "Fiji F200 200mm Thermal/Plasma ALD Systems: Installation and Use Manual." CAW-02635 Rev. 0.6 (Mar. 13, 2012). Cambridge NanoTech Inc. pp 1-164 (2012).
- Ge et al. "Large-scale synthesis of NbS₂ nanosheets with controlled orientation on graphene by ambient pressure CVD," *Nanoscale*, vol. 5, 5773-5778 (2013).
- Gordon et al. "A Kinetic Model for Step Coverage by Atomic Layer Deposition in Narrow Holes or Trenches." *Chemical Vapor Deposition*. 9 [2]. pp. 73-78 (2003).
- Hansen. "A Primer on Vacuum Pressure Measurement." *Vacuum Technology & Coating*. Jun. 2009. pp. 36-42 (2009).
- Hansen. "Speed, Pressure and Throughput: Part 1 System Diagnostics." *Vacuum Technology & Coating*. Sep. 2011. pp. 14-17 (2011).
- Hansen. "Speed, Pressure and Throughput: Part 2 Managing Gas Flow in High Vacuum Systems." *Vacuum Technology & Coating*. Oct. 2011. pp. 19-22 (2011).
- Hansen. "Speed, Pressure and Throughput: Part 3 Automating the Pressure Control Process." *Vacuum Technology & Coating*. Nov. 2011. pp. 22-25 (2011).
- Hansen. "Speed, Pressure and Throughput: Part 4 Outgassing and Base Pressure." *Vacuum Technology & Coating*. Dec. 2011. pp. 22-25 (2011).
- Hansen. "Speed, Pressure and Throughput: Part 5 Leaks and Gas Flow in Leak Detection." *Vacuum Technology & Coating*. Jan. 2012. pp. 18-21 (2011).
- Khandelwal et al. "Low-temperature Ar/N₂ remote plasma nitridation of SiO₂ thin films," *J. Vacuum Science & Technology A*, 20(6), pp. 1989-1996 (2002).
- Kucheyev et al. "Mechanisms of Atomic Layer Deposition on Substrates with Ultrahigh Aspect Ratios." *Langmuir*. 24 [3], pp. 943-948 (2008).
- Londergan et al. "Engineered Low Resistivity Titanium-Tantalum Nitride Films by Atomic Layer Deposition," *Mat. Res. Soc. Symp. Proc.*, vol. 714E, pp. L5.3.1-L5.3.6 (2001).
- Naito et al. "Electrical Transport Properties in 2H—NbS₂, —NbSe₂, —TaS₂ and —TaSe₂," *J. of Physical Society of Japan*, vol. 51, No. 1, 219-227 (1982).
- Pichler. "Intrinsic Point Defects, Impurities and Their Diffusion in Silicon," Springer-Verlag Wien, p. 367 (2004).
- Tidman et al. "Resistivity of thin TaS₂ crystals," *Can. J. Phys.*, vol. 54, 2306-2309 (1976).
- Trumbore et al. "Solid solubilities of aluminum and gallium in germanium," *J. of Physics and Chemistry of Solids*, vol. 11, Issues 3-4, 239-240 (1959).
- CNIPA; Notice of Allowance dated May 22, 2020 in Application No. 201610028064.1.
- CNIPA; Office Action dated Mar. 26, 2020 in Application No. 201610131743.1.
- CNIPA; Office Action dated May 18, 2020 in Application No. 201610982040.X.
- CNIPA; Office Action dated May 29, 2020 in Application No. 201710131319.1.
- CNIPA; Office Action dated Jun. 1, 2020 in Application No. 201710173292.2.
- CNIPA; Notice of Allowance dated May 14, 2020 in Application No. 201930615780.4.
- CNIPA; Notice of Allowance dated Apr. 27, 2020 in Application No. 201930660355.7.
- CNIPA; Notice of Allowance dated Jun. 2, 2020 in Application No. 202030048819.1.
- CNIPA; Notice of Allowance dated May 15, 2020 in Application No. 202030053560.X.
- CNIPA; Notice of Allowance dated May 20, 2020 in Application No. 202030053634.X.
- KIPO; Notice of Allowance dated Apr. 23, 2020 in Application No. 10-2013-0050740.
- KIPO; Office Action dated Jun. 19, 2020 in Application No. 10-2013-0098575.
- KIPO; Notice of Allowance dated May 14, 2020 in Application No. 10-2013-0102026.
- KIPO; Office Action dated May 21, 2020 in Application No. 10-2014-0086902.
- KIPO; Office Action dated May 21, 2020 in Application No. 10-2014-0091092.
- KIPO; Office Action dated Apr. 22, 2020 in Application No. 10-2020-0009462.
- TIPO; Notice of Allowance dated May 4, 2020 in Application No. 105101536.
- TIPO; Office Action dated Apr. 14, 2020 in Application No. 105129977.
- TIPO; Office Action dated Mar. 17, 2020 in Application No. 105130130.
- TIPO; Office Action dated Feb. 21, 2020 in Application No. 108120947.
- USPTO; Advisory Action dated Apr. 24, 2020 in U.S. Appl. No. 14/219,839.
- USPTO; Advisory Action dated Apr. 24, 2020 in U.S. Appl. No. 14/219,879.
- USPTO; Non-Final Office Action dated Apr. 28, 2020 in U.S. Appl. No. 14/444,744.
- USPTO; Final Office Action dated May 15, 2020 in U.S. Appl. No. 14/457,058.
- USPTO; Advisory Action dated Jun. 22, 2020 in U.S. Appl. No. 14/829,565.
- USPTO; Final Office Action dated Jun. 1, 2020 in U.S. Appl. No. 15/135,258.
- USPTO; Non-Final Office Action dated Apr. 16, 2020 in U.S. Appl. No. 15/286,503.
- USPTO; Final Office Action dated May 13, 2020 in U.S. Appl. No. 15/377,439.
- USPTO; Non-Final Office Action dated May 27, 2020 in U.S. Appl. No. 15/402,993.
- USPTO; Final Office Action dated Apr. 17, 2020 in U.S. Appl. No. 15/491,726.
- USPTO; Final Office Action dated Jun. 16, 2020 in U.S. Appl. No. 15/636,307.
- USPTO; Notice of Allowance dated May 20, 2020 in U.S. Appl. No. 15/672,096.
- USPTO; Final Office Action dated May 27, 2020 in U.S. Appl. No. 15/690,017.

(56)

References Cited

OTHER PUBLICATIONS

- USPTO; Advisory Action dated Jun. 19, 2020 in U.S. Appl. No. 15/691,241.
- USPTO; Advisory Action dated May 26, 2020 in U.S. Appl. No. 15/798,201.
- USPTO; Advisory Action dated May 19, 2020 in U.S. Appl. No. 15/802,154.
- USPTO; Non-Final Office Action dated Apr. 24, 2020 in U.S. Appl. No. 15/815,483.
- USPTO; Final Office Action dated Jun. 11, 2020 in U.S. Appl. No. 15/861,418.
- USPTO; Advisory Action dated Jun. 5, 2020 in U.S. Appl. No. 15/890,037.
- USPTO; Final Office Action dated Jun. 15, 2020 in U.S. Appl. No. 15/896,986.
- USPTO; Non-Final Office Action dated May 1, 2020 in U.S. Appl. No. 15/917,224.
- USPTO; Advisory Action dated May 15, 2020 in U.S. Appl. No. 15/923,834.
- USPTO; Non-Final Office Action dated May 1, 2020 in U.S. Appl. No. 15/925,532.
- USPTO; Advisory Action dated Apr. 23, 2020 in U.S. Appl. No. 15/940,759.
- USPTO; Final Office Action dated Apr. 30, 2020 in U.S. Appl. No. 15/962,980.
- USPTO; Non-Final Office Action dated May 15, 2020 in U.S. Appl. No. 15/974,988.
- USPTO; Non-Final Office Action dated Jun. 12, 2020 in U.S. Appl. No. 15/985,539.
- USPTO; Non-Final Office Action dated Feb. 20, 2020 in U.S. Appl. No. 15/996,286.
- USPTO; Non-Final Office Action dated Jun. 5, 2020 in U.S. Appl. No. 16/000,125.
- USPTO; Non-Final Office Action dated Apr. 22, 2020 in U.S. Appl. No. 16/000,156.
- USPTO; Non-Final Office Action dated May 7, 2020 in U.S. Appl. No. 16/004,041.
- USPTO; Notice of Allowance dated Jun. 24, 2020 in U.S. Appl. No. 16/014,981.
- USPTO; Notice of Allowance dated May 26, 2020 in U.S. Appl. No. 16/036,692.
- USPTO; Non-Final Office Action dated Apr. 30, 2020 in U.S. Appl. No. 16/055,532.
- USPTO; Non-Final Office Action dated May 27, 2020 in U.S. Appl. No. 16/100,012.
- USPTO; Final Office Action dated Jun. 23, 2020 in U.S. Appl. No. 16/105,745.
- USPTO; Final Office Action dated Apr. 21, 2020 in U.S. Appl. No. 16/105,761.
- USPTO; Final Office Action dated Jun. 26, 2020 in U.S. Appl. No. 16/105,802.
- USPTO; Non-Final Office Action dated Jun. 22, 2020 in U.S. Appl. No. 16/128,282.
- USPTO; Non-Final Office Action dated Apr. 21, 2020 in U.S. Appl. No. 16/130,798.
- USPTO; Final Office Action dated Jun. 5, 2020 in U.S. Appl. No. 16/132,142.
- USPTO; Advisory Action dated Jun. 9, 2020 in U.S. Appl. No. 16/158,077.
- USPTO; Notice of Allowance dated Jun. 19, 2020 in U.S. Appl. No. 16/161,744.
- USPTO; Non-Final Office Action dated May 29, 2020 in U.S. Appl. No. 16/205,899.
- USPTO; Final Office Action dated Jun. 19, 2020 in U.S. Appl. No. 16/219,555.
- USPTO; Final Office Action dated Jun. 15, 2020 in U.S. Appl. No. 16/242,829.
- USPTO; Notice of Allowance dated May 29, 2020 in U.S. Appl. No. 16/245,006.
- USPTO; Non-Final Office Action dated Apr. 24, 2020 in U.S. Appl. No. 16/251,534.
- USPTO; Non-Final Office Action dated May 27, 2020 in U.S. Appl. No. 16/252,567.
- USPTO; Non-Final Office Action dated Apr. 16, 2020 in U.S. Appl. No. 16/255,639.
- USPTO; Non-Final Office Action dated Jun. 30, 2020 in U.S. Appl. No. 16/258,187.
- USPTO; Notice of Allowance dated May 21, 2020 in U.S. Appl. No. 16/280,964.
- USPTO; Notice of Allowance dated Apr. 16, 2020 in U.S. Appl. No. 16/427,288.
- USPTO; Non-Final Office Action dated May 12, 2020 in U.S. Appl. No. 16/454,063.
- USPTO; Notice of Allowance dated Apr. 17, 2020 in U.S. Appl. No. 16/455,406.
- USPTO; Non-Final Office Action dated Jun. 11, 2020 in U.S. Appl. No. 16/598,768.
- USPTO; Notice of Allowance dated Apr. 21, 2020 in U.S. Appl. No. 16/674,894.
- USPTO; Non-Final Office Action dated Apr. 13, 2020 in U.S. Appl. No. 16/833,279.
- USPTO; Notice of Allowance dated Jun. 10, 2020 in U.S. Appl. No. 29/615,000.
- USPTO; Non-Final Office Action dated Apr. 24, 2020 in U.S. Appl. No. 29/726,623.
- WIPO; International Search Report and Written Opinion dated Apr. 29, 2019 in Application No. PCT/NL2018/050791.
- Chatterjee et al. "Chemical Vapor Deposition of Boron Nitride Nanosheets on Metallic Substrates via Decaborane/Ammonia Reactions", *Chem. Mater.* 23, pp. 4414-4416 (2011).
- Fallica et al., "Dynamic Absorption Coefficients of Chemically Amplified Resists and Nonchemically Amplified Resists at Extreme Ultraviolet", *J. Micro/Nanolith. MEMS MOEMS* 15(3), pp. 033506-1-033506-7 (2016).
- Glass et al. "The Chemical Vapor Deposition of Metal Boride Thin Films from Polyhedral Cluster Species", Winter and Hoffman, *Inorganic Materials Synthesis. ACS Symposium Series; American Chemical Society: Washington DC, Chapter 10*, pp. 130-143 (1999).
- Jensen et al. "Titanium, Zirconium, and Hafnium Tetrahydroborates as "Tailored" CVD Precursors for Metal Diboride Thin Films", *J. Am. Chem. Soc.* 110, pp. 1643-1644 (1988).
- Kliem et al. "Silyl Group Migrations Between Oxygen and Nitrogen in Aminosiloxanes"; *Organosilicon Chemistry VI: from Molecules to Materials*; pp. 216-221 (2005).
- Lewis et al. "Hawley's Condensed Chemical Dictionary" 12th Edition; excerpt pp. 1027-1038 (2005).
- Roddy, "Transport Reactions and Vaporization Studies of Some Vanadium Halides", Iowa State university of Science and Technology dissertation, 207 pages (1962).
- Spear et al., "Chemical Transport Reactions in the Vanadium-Silicon-Oxygen System and the Ternary Phase Diagram", *Journal of the Less-Common Metals*, 14, pp. 69-75 (1968).
- Su et al. "A Polymer Precursor Route to Metal Borides", *Chem. Mater.*, 5, pp. 1659-1668 (1993).
- CNIPA; Office Action dated Jan. 21, 2020 in Application No. 201610028064.1.
- CNIPA; Office Action dated Feb. 28, 2020 in Application No. 201610897958.4.
- EPO; Extended European Search Report dated Mar. 3, 2020 in Application No. 19205558.0.
- KIPO; Office Action dated Feb. 28, 2020 in Application No. 10-2013-0049598.
- KIPO; Notice of Allowance dated Feb. 27, 2020 in Application No. 10-2013-0089998.
- KIPO; Notice of Allowance dated Mar. 4, 2020 in Application No. 10-2013-0114079.
- KIPO; Office Action dated Mar. 30, 2020 in Application No. 10-2014-0011764.
- KIPO; Office Action dated Mar. 11, 2020 in Application No. 10-2014-0103853.
- KIPO; Office Action dated Feb. 12, 2020 in Application No. 10-2020-7000992.

(56)

References Cited

OTHER PUBLICATIONS

- TIPO; Notice of Allowance dated Feb. 20, 2020 in Application No. 102125191.
- TIPO; Office Action dated Jan. 17, 2020 in Application No. 104108277.
- TIPO; Notice of Allowance dated Jan. 15, 2020 in Application No. 105114105.
- TIPO; Notice of Allowance dated Mar. 13, 2020 in Application No. 105119533.
- TIPO; Office Action dated Jan. 17, 2020 in Application No. 105122586.
- TIPO; Office Action dated Jan. 17, 2020 in Application No. 107127688.
- TIPO; Office Action dated Feb. 3, 2020 in Application No. 108114221.
- TIPO; Notice of Allowance dated Mar. 12, 2020 in Application No. 108129100.
- USPTO; Final Office Action dated Feb. 20, 2020 in U.S. Appl. No. 14/444,744.
- USPTO; Non-Final Office Action dated Mar. 5, 2020 in U.S. Appl. No. 14/508,489.
- USPTO; Final Office Action dated Mar. 3, 2020 in U.S. Appl. No. 14/829,565.
- USPTO; Notice of Allowance dated Mar. 5, 2020 in U.S. Appl. No. 15/060,412.
- USPTO; Advisory Action dated Mar. 31, 2020 in U.S. Appl. No. 15/286,503.
- USPTO; Final Office Action dated Feb. 19, 2020 in U.S. Appl. No. 15/402,993.
- USPTO; Advisory Action dated Apr. 2, 2020 in U.S. Appl. No. 15/402,993.
- USPTO; Notice of Allowance dated Feb. 28, 2020 in U.S. Appl. No. 15/589,849.
- USPTO; Non-Final Office Action dated Mar. 10, 2020 in U.S. Appl. No. 15/611,707.
- USPTO; Notice of Allowance dated Feb. 28, 2020 in U.S. Appl. No. 15/615,489.
- USPTO; Non-Final Office Action dated Mar. 11, 2020 in U.S. Appl. No. 15/636,307.
- USPTO; Final Office Action dated Mar. 27, 2020 in U.S. Appl. No. 15/672,096.
- USPTO; Advisory Action dated Mar. 16, 2020 in U.S. Appl. No. 15/726,959.
- USPTO; Non-Final Office Action dated Apr. 3, 2020 in U.S. Appl. No. 15/726,959.
- USPTO; Notice of Allowance dated Mar. 12, 2020 in U.S. Appl. No. 15/795,056.
- USPTO; Final Office Action dated Mar. 19, 2020 in U.S. Appl. No. 15/798,201.
- USPTO; Final Office Action dated Mar. 11, 2020 in U.S. Appl. No. 15/802,154.
- USPTO; Advisory Action dated Mar. 25, 2020 in U.S. Appl. No. 15/815,483.
- USPTO; Non-Final Office Action dated Mar. 17, 2020 in U.S. Appl. No. 15/835,328.
- USPTO; Non-Final Office Action dated Feb. 20, 2020 in U.S. Appl. No. 15/835,352.
- USPTO; Non-Final Office Action dated Mar. 30, 2020 in U.S. Appl. No. 15/860,564.
- USPTO; Non-Final Office Action dated Mar. 20, 2020 in U.S. Appl. No. 15/861,418.
- USPTO; Final Office Action dated Feb. 26, 2020 in U.S. Appl. No. 15/890,037.
- USPTO; Non-Final Office Action dated Mar. 24, 2020 in U.S. Appl. No. 15/896,986.
- USPTO; Notice of Allowance dated Mar. 27, 2020 in U.S. Appl. No. 15/897,578.
- USPTO; Final Office Action dated Mar. 12, 2020 in U.S. Appl. No. 15/923,834.
- USPTO; Final Office Action dated Feb. 19, 2020 in U.S. Appl. No. 15/940,759.
- USPTO; Notice of Allowance dated Mar. 12, 2020 in U.S. Appl. No. 15/949,990.
- USPTO; Non-Final Office Action dated Apr. 2, 2020 in U.S. Appl. No. 15/974,948.
- USPTO; Notice of Allowance dated Apr. 3, 2020 in U.S. Appl. No. 15/985,261.
- USPTO; Non-Final Office Action dated Apr. 1, 2020 in U.S. Appl. No. 15/997,445.
- USPTO; Non-Final Office Action dated Mar. 3, 2020 in U.S. Appl. No. 16/000,109.
- USPTO; Advisory Action dated Apr. 3, 2020 in U.S. Appl. No. 16/000,125.
- USPTO; Non-Final Office Action dated Mar. 4, 2020 in U.S. Appl. No. 16/036,692.
- USPTO; Advisory Action dated Feb. 28, 2020 in U.S. Appl. No. 16/038,024.
- USPTO; Notice of Allowance dated Mar. 23, 2020 in U.S. Appl. No. 16/038,024.
- USPTO; Notice of Allowance dated Apr. 3, 2020 in U.S. Appl. No. 16/039,867.
- USPTO; Non-Final Office Action dated Feb. 20, 2020 in U.S. Appl. No. 16/105,745.
- USPTO; Non-Final Office Action dated Feb. 24, 2020 in Application No. U.S. Appl. No. 16/105,761.
- USPTO; Non-Final Office Action dated Mar. 19, 2020 in U.S. Appl. No. 16/105,802.
- USPTO; Non-Final Office Action dated Mar. 16, 2020 in U.S. Appl. No. 16/116,708.
- USPTO; Non-Final Office Action dated Feb. 28, 2020 in U.S. Appl. No. 16/137,974.
- USPTO; Final Office Action dated Mar. 2, 2020 in U.S. Appl. No. 16/158,077.
- USPTO; Final Office Action dated Mar. 17, 2020 in U.S. Appl. No. 16/161,744.
- USPTO; Notice of Allowance dated Mar. 5, 2020 in U.S. Appl. No. 16/167,225.
- USPTO; Non-Final Office Action dated Feb. 19, 2020 in U.S. Appl. No. 16/242,829.
- USPTO; Advisory Action dated Apr. 3, 2020 in U.S. Appl. No. 16/251,534.
- USPTO; Notice of Allowance dated Apr. 15, 2020 in U.S. Appl. No. 16/317,774.
- USPTO; Non-Final Office Action dated Mar. 2, 2020 in U.S. Appl. No. 16/356,394.
- USPTO; Notice of Allowance dated Mar. 30, 2020 in U.S. Appl. No. 16/417,938.
- USPTO; Final Office Action dated Jan. 10, 2020 in U.S. Appl. No. 16/674,894.
- WIPO; International Search Report and Written Opinion dated Apr. 17, 2019 in Application No. PCT/NL2018/050787.
- Rossing et al. "Acoustics of Eastern and Western bells, Old and New" J of Acoustical Society of Japan; 10(5); pp. 241-252 (1989).
- EPO; Notice of Allowance dated Oct. 16, 2019 in Application No. 09836647.9.
- KIPO; Notice of Allowance dated Sep. 27, 2019 in Application No. 10-2012-7004062.
- KIPO; Office Action dated Nov. 27, 2019 in Application No. 10-2013-0050740.
- KIPO; Office Action dated Nov. 12, 2019 in Application No. 10-2013-0102026.
- KIPO; Notice of Allowance dated Oct. 21, 2019 in Application No. 10-2013-0109390.
- KIPO; Notice of Allowance dated Oct. 28, 2019 in Application No. 10-2013-0121554.
- KIPO; Notice of Allowance dated Nov. 29, 2019 in Application No. 10-2019-0127773.
- TIPO; Office Action dated Nov. 6, 2019 in Application No. 105101537.
- TIPO; Office Action dated Oct. 1, 2019 in Application No. 105114105.
- TIPO; Office Action dated Oct. 3, 2019 in Application No. 105119533.
- TIPO; Office Action dated Oct. 28, 2019 in Application No. 105122715.
- USPTO; Non-Final Office Action dated Oct. 31, 2019 in U.S. Appl. No. 14/457,058.
- USPTO; Advisory Action dated Oct. 28, 2019 in U.S. Appl. No. 14/508,489.

(56)

References Cited

OTHER PUBLICATIONS

- USPTO; Notice of Allowance dated Nov. 14, 2019 in U.S. Appl. No. 14/793,323.
- USPTO; Final Office Action dated Oct. 24, 2019 in U.S. Appl. No. 15/135,258.
- USPTO; Advisory Action dated Oct. 22, 2019 in U.S. Appl. No. 15/205,827.
- USPTO; Non-Final Office Action dated Nov. 7, 2019 in U.S. Appl. No. 15/377,439.
- USPTO; Final Office Action dated Sep. 18, 2019 in U.S. Appl. No. 15/380,921.
- USPTO; Non-Final Office Action dated Oct. 24, 2019 in U.S. Appl. No. 15/402,993.
- USPTO; Notice of Allowance dated Oct. 7, 2019 in U.S. Appl. No. 15/489,453.
- USPTO; Non-Final Office Action dated Oct. 3, 2019 in U.S. Appl. No. 15/491,726.
- USPTO; Advisory Action dated Sep. 20, 2019 in U.S. Appl. No. 15/589,861.
- USPTO; Final Office Action dated Nov. 12, 2019 in U.S. Appl. No. 15/636,307.
- USPTO; Notice of Allowance dated Nov. 7, 2019 in U.S. Appl. No. 15/660,797.
- USPTO; Non-Final Office Action dated Oct. 10, 2019 in U.S. Appl. No. 15/672,096.
- USPTO; Advisory Action dated Sep. 23, 2019 in U.S. Appl. No. 15/672,119.
- USPTO; Non-Final Office Action dated Nov. 20, 2019 in U.S. Appl. No. 15/690,017.
- USPTO; Notice of Allowance dated Nov. 7, 2019 in U.S. Appl. No. 15/707,786.
- USPTO; Non-Final Office Action dated Sep. 26, 2019 in U.S. Appl. No. 15/727,432.
- USPTO; Non-Final Office Action dated Nov. 20, 2019 in U.S. Appl. No. 15/795,056.
- USPTO; Non-Final Office Action dated Nov. 15, 2019 in U.S. Appl. No. 15/802,154.
- USPTO; Final Office Action dated Nov. 13, 2019 in U.S. Appl. No. 15/860,564.
- USPTO; Advisory Action dated Nov. 5, 2019 in U.S. Appl. No. 15/879,209.
- USPTO; Non-Final Office Action dated Oct. 24, 2019 in U.S. Appl. No. 15/890,037.
- USPTO; Final Office Action dated Nov. 19, 2019 in U.S. Appl. No. 15/896,986.
- USPTO; Non-Final Office Action dated Jul. 25, 2019 in U.S. Appl. No. 16/039,867.
- USPTO; Notice of Allowance dated Oct. 3, 2019 in U.S. Appl. No. 16/200,100.
- USPTO; Non-Final Office Action dated Sep. 24, 2019 in U.S. Appl. No. 16/251,534.
- USPTO; Notice of Allowance dated Oct. 30, 2019 in U.S. Appl. No. 29/604,101.
- USPTO; Final Office Action dated Jul. 15, 2019 in U.S. Appl. No. 29/646,377.
- USPTO; Notice of Allowance dated Nov. 14, 2019 in U.S. Appl. No. 29/646,377.
- Ellis et al. "Nitrous Oxide (N₂O) Processing for Silicon Oxynitride Gate Dielectrics." IBM Journal of Research and Development. 1999. 43[3]. pp. 287-300. (1999).
- Hayashi et al. "Spectroscopic properties of nitrogen doped hydrogenated amorphous carbon films grown by radio frequency plasma-enhanced chemical vapor deposition," Journal of Applied Physics. vol. 89, No. 12, pp. 7924-7931 (2001).
- Miller et al. "Carbon nitrides: synthesis and characterization of a new class of functional materials," Phys.Chem.Chem.Phys., 19, pp. 15613-15638 (2017).
- Ohtsu et al. "Influences of Gap Distance on Plasma Characteristics in Narrow Gap Capacitatively Coupled Radio-Frequency Discharge," vol. 43, No. 2, pp. 795-799 (2004).
- CNIPA; Office Action dated Mar. 30, 2021 in Application No. 201610131743.1.
- CNIPA; Office Action dated Mar. 1, 2021 in Application No. 201710131319.1.
- CNIPA; Notice of Allowance dated Mar. 30, 2021 in Application No. 201710762817.6.
- CNIPA; Office Action dated Jan. 28, 2021 in Application No. 201711057557.9.
- CNIPA; Office Action dated Jan. 26, 2021 in Application No. 201711057929.8.
- CNIPA; Office Action dated Apr. 19, 2021 in Application No. 201711328250.8.
- CNIPA; Notice of Allowance dated Apr. 7, 2021 in Application No. 201780044761.9.
- CNIPA; Office Action dated Jan. 29, 2021 in Application No. 201780076230.8.
- CNIPA; Office Action dated Jan. 27, 2021 in Application No. 201780076321.1.
- CNIPA; Office Action dated Mar. 24, 2021 in Application No. 201880048547.5.
- CNIPA; Office Action dated Dec. 22, 2020 in Application No. 201910378791.4.
- CNIPA; Notice of Allowance dated Apr. 7, 2021 in Application No. 202030579755.8.
- EPO; Extended European Search Report dated Apr. 6, 2021 in Application No. 21150514.4.
- JPO; Notice of Allowance dated Apr. 6, 2021 in Application No. 2017-139817.
- JPO; Office Action dated Mar. 31, 2021 in Application No. 2018-024655.
- JPO; Notice of Allowance dated Mar. 17, 2021 in Application No. 2020-010953.
- KIPO; Office Action dated Mar. 23, 2021 in Application No. 10-2014-0011765.
- KIPO; Office Action dated Apr. 27, 2021 in Application No. 10-2014-0027217.
- KIPO; Notice of Allowance dated Apr. 15, 2021 in Application No. 10-2014-0103853.
- KIPO; Notice of Allowance dated Mar. 25, 2021 in Application No. 10-2014-0128626.
- KIPO; Office Action dated Apr. 20, 2021 in Application No. 10-2014-0136089.
- KIPO; Office Action dated Mar. 19, 2021 in Application No. 10-2014-0156196.
- KIPO; Office Action dated Mar. 29, 2021 in Application No. 10-2014-0165685.
- KIPO; Office Action dated Apr. 5, 2021 in Application No. 10-2015-0031720.
- KIPO; Office Action dated Apr. 19, 2021 in Application No. 10-2015-0035094.
- KIPO; Office Action dated Mar. 8, 2021 in Application No. 10-2017-0054647.
- KIPO; Office Action dated Mar. 10, 2021 in Application No. 10-2017-0055703.
- KIPO; Notice of Allowance dated May 24, 2021 in Application No. 10-2020-0101096.
- KIPO; Notice of Allowance dated Apr. 1, 2021 in Application No. 30-2020-0030139 (M001).
- KIPO; Notice of Allowance dated Apr. 1, 2021 in Application No. 30-2020-0030139 (M002).
- TIPO; Notice of Allowance dated May 13, 2021 in Application No. 105122394.
- TIPO; Notice of Allowance dated Mar. 5, 2021 in Application No. 105131284.
- TIPO; Office Action dated Feb. 25, 2021 in Application No. 105134275.
- TIPO; Notice of Allowance dated Mar. 4, 2021 in Application No. 106100823.
- TIPO; Notice of Allowance dated May 6, 2021 in Application No. 106108522.
- TIPO; Notice of Allowance dated Mar. 4, 2021 in Application No. 106111693.

(56)

References Cited

OTHER PUBLICATIONS

- TIPO; Office Action dated Feb. 25, 2021 in Application No. 106121797.
- TIPO; Office Action dated Apr. 26, 2021 in Application No. 106122231.
- TIPO; Office Action dated Apr. 22, 2021 in Application No. 106124126.
- TIPO; Office Action dated Apr. 22, 2021 in Application No. 106124128.
- TIPO; Notice of Allowance dated Mar. 25, 2021 in Application No. 106124130.
- TIPO; Office Action dated Mar. 4, 2021 in Application No. 106127948.
- TIPO; Office Action dated Mar. 15, 2021 in Application No. 106129971.
- TIPO; Office Action dated Apr. 7, 2021 in Application No. 106135925.
- TIPO; Office Action dated Apr. 7, 2021 in Application No. 106136905.
- TIPO; Office Action dated Mar. 29, 2021 in Application No. 106143559.
- TIPO; Office Action dated Mar. 31, 2021 in Application No. 106143570.
- TIPO; Office Action dated Jan. 15, 2021 in Application No. 108142842.
- TIPO; Office Action dated Jan. 25, 21 in Application No. 108143562.
- TIPO; Notice of Allowance dated May 18, 2021 in Application No. 109300595.
- TIPO; Notice of Allowance dated Mar. 30, 2021 in Application No. 109305460.
- USPTO; Notice of Allowance dated Feb. 10, 2021 in U.S. Appl. No. 14/219,839.
- USPTO; Advisory Action dated Apr. 13, 2021 in U.S. Appl. No. 14/829,565.
- USPTO; Non-Final Office Action dated May 12, 2021 in U.S. Appl. No. 14/829,565.
- USPTO; Final Office Action dated Feb. 24, 2021 in U.S. Appl. No. 15/262,990.
- USPTO; Advisory Action dated Apr. 28, 2021 in U.S. Appl. No. 15/262,990.
- USPTO; Final Office Action dated Mar. 25, 2021 in U.S. Appl. No. 15/286,503.
- USPTO; Advisory Action dated Apr. 30, 2021 in U.S. Appl. No. 15/377,439.
- USPTO; Final Office Action dated Jan. 7, 2021 in U.S. Appl. No. 15/380,909.
- USPTO; Non-Final Office Action dated Feb. 9, 2021 in U.S. Appl. No. 15/402,993.
- USPTO; Final Office Action dated May 21, 2021 in U.S. Appl. No. 15/402,993.
- USPTO; Final Office Action dated Jun. 2, 2021 in U.S. Appl. No. 15/611,707.
- USPTO; Advisory Action dated Mar. 25, 2021 in U.S. Appl. No. 15/636,307.
- USPTO; Non-Final Office Action dated Apr. 21, 2021 in U.S. Appl. No. 15/636,307.
- USPTO; Final Office Action dated Mar. 10, 2021 in U.S. Appl. No. 15/690,017.
- USPTO; Notice of Allowance dated Apr. 16, 2021 in U.S. Appl. No. 15/691,241.
- USPTO; Non-Final Office Action dated Mar. 18, 2021 in U.S. Appl. No. 15/835,328.
- USPTO; Notice of Allowance dated Mar. 19, 2021 in U.S. Appl. No. 15/890,037.
- USPTO; Final Office Action dated Apr. 19, 2021 in U.S. Appl. No. 15/909,705.
- USPTO; Non-Final Office Action dated May 20, 2021 in U.S. Appl. No. 15/917,224.
- USPTO; Non-Final Office Action dated Feb. 18, 2021 in U.S. Appl. No. 15/923,834.
- USPTO; Advisory Action dated Apr. 28, 2021 in U.S. Appl. No. 15/940,729.
- USPTO; Notice of Allowance dated Apr. 7, 2021 in U.S. Appl. No. 15/940,759.
- USPTO; Advisory Action dated Feb. 22, 2021 in U.S. Appl. No. 15/962,980.
- USPTO; Final Office Action dated Apr. 13, 2021 in U.S. Appl. No. 15/967,146.
- USPTO; Advisory Action dated Jun. 2, 2021 in U.S. Appl. No. 15/967,146.
- USPTO; Non-Final Office Action dated Feb. 19, 2021 in U.S. Appl. No. 15/974,948.
- USPTO; Non-Final Office Action dated May 25, 2021 in U.S. Appl. No. 15/985,539.
- USPTO; Non-Final Office Action dated Apr. 5, 2021 in U.S. Appl. No. 15/996,286.
- USPTO; Non-Final Office Action dated Feb. 4, 2021 in U.S. Appl. No. 16/000,109.
- USPTO; Non-Final Office Action dated May 19, 2021 in U.S. Appl. No. 16/000,125.
- USPTO; Notice of Allowance dated Feb. 5, 2021 in U.S. Appl. No. 16/000,156.
- USPTO; Non-Final Office Action dated Mar. 19, 2021 in U.S. Appl. No. 16/004,041.
- USPTO; Final Office Action dated Mar. 23, 2021 in U.S. Appl. No. 16/039,817.
- USPTO; Advisory Action dated May 28, 2021 in U.S. Appl. No. 16/039,817.
- USPTO; Final Office Action dated Mar. 8, 2021 in U.S. Appl. No. 16/042,791.
- USPTO; Advisory Action dated May 14, 2021 in U.S. Appl. No. 16/042,791.
- USPTO; Notice of Allowance dated Mar. 10, 2021 in U.S. Appl. No. 16/055,532.
- USPTO; Final Office Action dated Mar. 23, 2021 in U.S. Appl. No. 16/105,745.
- USPTO; Final Office Action dated Mar. 24, 2021 in U.S. Appl. No. 16/105,761.
- USPTO; Advisory Action dated May 20, 2021 in U.S. Appl. No. 16/105,761.
- USPTO; Final Office Action dated Mar. 18, 2021 in U.S. Appl. No. 16/105,802.
- USPTO; Advisory Action dated May 27, 2021 in U.S. Appl. No. 16/105,802.
- USPTO; Advisory Action dated Feb. 17, 2021 in U.S. Appl. No. 16/108,950.
- USPTO; Non-Final Office Action dated Apr. 13, 2021 in U.S. Appl. No. 16/108,950.
- USPTO; Notice of Allowance dated Mar. 23, 2021 in U.S. Appl. No. 16/116,708.
- USPTO; Advisory Action dated Mar. 10, 2021 in U.S. Appl. No. 16/117,530.
- USPTO; Non-Final Office Action dated Mar. 23, 2021 in U.S. Appl. No. 16/151,074.
- USPTO; Final Office Action dated May 6, 2021 in U.S. Appl. No. 16/152,260.
- USPTO; Notice of Allowance dated Feb. 24, 2021 in U.S. Appl. No. 16/167,164.
- USPTO; Non-Final Office Action dated Feb. 19, 2021 in U.S. Appl. No. 16/172,535.
- USPTO; Final Office Action dated May 27, 2021 in U.S. Appl. No. 16/172,535.
- USPTO; Advisory Action dated Apr. 5, 2021 in U.S. Appl. No. 16/176,517.
- USPTO; Notice of Allowance dated May 13, 2021 in U.S. Appl. No. 16/176,517.
- USPTO; Notice of Allowance dated Feb. 19, 2021 in U.S. Appl. No. 16/183,258.
- USPTO; Notice of Allowance dated Feb. 10, 2021 in U.S. Appl. No. 16/205,899.
- USPTO; Non-Final Office Action dated Mar. 29, 2021 in U.S. Appl. No. 16/206,589.
- USPTO; Advisory Action dated Feb. 25, 2021 in U.S. Appl. No. 16/210,922.
- USPTO; Final Office Action dated Mar. 29, 2021 in U.S. Appl. No. 16/219,555.

(56)

References Cited

OTHER PUBLICATIONS

USPTO; Non-Final Office Action dated May 2, 2021 in U.S. Appl. No. 16/240,392.

USPTO; Advisory Action dated Jan. 26, 2021 in U.S. Appl. No. 16/251,534.

USPTO; Non-Final Office Action dated Feb. 23, 2021 in U.S. Appl. No. 16/251,534.

USPTO; Non-Final Office Action dated Mar. 30, 2021 in U.S. Appl. No. 16/252,567.

USPTO; Non-Final Office Action dated Mar. 4, 2021 in U.S. Appl. No. 16/252,569.

USPTO; Non-Final Office Action dated Apr. 20, 2021 in U.S. Appl. No. 16/397,045.

USPTO; Notice of Allowance dated Mar. 10, 2021 in U.S. Appl. No. 16/400,814.

USPTO; Non-Final Office Action dated May 7, 2021 in U.S. Appl. No. 16/423,824.

USPTO; Notice of Allowance dated Apr. 28, 2021 in U.S. Appl. No. 16/453,249.

USPTO; Final Office Action dated May 20, 2021 in U.S. Appl. No. 16/468,258.

USPTO; Notice of Allowance dated Apr. 26, 2021 in U.S. Appl. No. 16/517,122.

USPTO; Final Office Action dated May 12, 2021 in U.S. Appl. No. 16/546,543.

USPTO; Non-Final Office Action dated Feb. 1, 2021 in U.S. Appl. No. 16/563,473.

USPTO; Non-Final Office Action dated May 10, 2021 in U.S. Appl. No. 16/601,593.

USPTO; Non-Final Office Action dated Feb. 24, 2021 in U.S. Appl. No. 16/637,134.

USPTO; Notice of Allowance dated Jun. 2, 2021 in U.S. Appl. No. 16/637,134.

USPTO; Notice of Allowance dated Apr. 30, 2021 in U.S. Appl. No. 16/685,787.

USPTO; Non-Final Office Action dated Apr. 5, 2021 in Application No. 16/704,835.

USPTO; Final Office Action dated Feb. 22, 2021 in U.S. Appl. No. 16/713,311.

USPTO; Notice of Allowance dated May 20, 2021 in U.S. Appl. No. 16/752,514.

USPTO; Notice of Allowance dated May 24, 2021 in U.S. Appl. No. 16/765,125.

USPTO; Non-Final Office Action dated Apr. 15, 2021 in U.S. Appl. No. 16/789,138.

USPTO; Notice of Allowance dated May 12, 2021 in U.S. Appl. No. 16/800,114.

USPTO; Non-Final Office Action dated Apr. 5, 2021 in U.S. Appl. No. 16/816,078.

USPTO; Non-Final Office Action dated May 19, 2021 in U.S. Appl. No. 16/828,753.

USPTO; Non-Final Office Action dated May 4, 2021 in U.S. Appl. No. 16/872,045.

USPTO; Non-Final Office Action dated May 3, 2021 in U.S. Appl. No. 16/878,443.

USPTO; Non-Final Office Action dated Dec. 31, 2020 in U.S. Appl. No. 16/924,595.

USPTO; Non-Final Office Action dated May 25, 2021 in U.S. Appl. No. 16/935,280.

USPTO; Non-Final Office Action dated Apr. 14, 2021 in U.S. Appl. No. 17/009,093.

USPTO; Ex Parte Quayle Action dated Apr. 13, 2021 in U.S. Appl. No. 29/679,620.

USPTO; Notice of Allowance dated May 19, 2021 in U.S. Appl. No. 29/702,881.

Aubin et al. "Very low temperature (450° C.) selective epitaxial growth of heavily in situ boron-doped SiGe layers" *Semiconductor Science and Technology*, 30, 10 pages (2015).

Barnscheidt et al. "Highly boron-doped germanium layers on Si(001) grown by carbon-mediated epitaxy" *Semiconductor Science and Technology*, 33, 9 pages (2018).

Belyansky et al. "Low Temperature Borophosphosilicate Glass (BPSG) Process for High Aspect Ratio Gap Fill" www.electrochem.org/dl/ma/201/pdfs/0705.pdf, downloaded May 15, 2021, 1 page.

Cheremisin et al. "UV-laser modification and selective ion-beam etching of amorphous vanadium pentoxide thin films" *Phys. Status Solidi A, Applications and materials science*, 206 (7), pp. 1484-1487 (2009).

Dingemans et al. "Plasma-Assisted ALD for the Conformal Deposition of SiO₂: Process, Material and Electronic Properties" *J of the Electrochemical Society*, 159(3), H277-H285 (2012).

G02-1152 "Atomic Layer Deposition of Al₂O₃ with Alcohol Oxidants for Impeding Substrate Oxidation" Abstract. Oct. 16, 2019 (2019).

Imamura et al. "Cyclic C₄F₈ and O₂ plasma etching of TiO₂ for high-aspect-ratio three-dimensional devices" *Template for JJAP Regular Papers*, Jan. 2014, p. 29 (2014).

Kim et al. "A process for topographically selective deposition on 3D nanostructures by ion implantation" *ACS Nano*, 10, 4, 4451-4458 (2016).

Lee et al. "Ultraviolet light enhancement of Ta₂O₅ dry etch rates" *J. of Vacuum Science & Technology B: Microelectronics and Nanometer Structures Processing, Measurement, and Phenomena*, 18, pp. 293-295 (2000).

Musschoot et al. "Atomic layer deposition of titanium nitride from TDMAT precursor" *Microelectronic Engineering*, 86, pp. 72-77 (2009).

Noircler et al. "Transmission electron microscopy characterization of low temperature boron doped silicon epitaxial films" *CrystEngComm*, 22(33), pp. 5464-5472 (2020).

Oyama et al. "Topotactic synthesis of vanadium nitride solid foams" *Journal of Materials Research* vol. 8. No. 6, pp. 1450-1454 (1993).

Rimoldi et al. "Atomic Layer Deposition of Rhenium-Aluminum Oxide Thin Films and ReOx Incorporation in a Metal-Organic Framework" *Applied Materials & Interfaces*, 9, pp. 35067-35074 (2017).

Standard Motor Products LX249 Ignition Pick Up, Nov. 11, 2005, Amazon.com, May 10, 2021. URL: <https://www.amazon.com/Standard-Motor-Products-LX249-Ignition/dp/B000C7ZTS4/> (2005).

Tao et al. "Improved performance of GeON as charge storage layer in flash memory by optimal annealing" *Microelectronics Reliability*, vol. 52, pp. 2597-2601 (2012).

Wirths et al. "Low temperature RPCVD epitaxial growth of Si_{1-x}Ge_x using Si₂H₆ and Ge₂H₆" *Solid-State Electronics*, 88, pp. 2-9 (2013).

Yanguas-Gil et al. "Modulation of the Growth Per Cycle in Atomic Layer Deposition Using Reversible Surface Functionalization" *Chemistry of Materials*, 25, pp. 4849-4860 (2013).

* cited by examiner

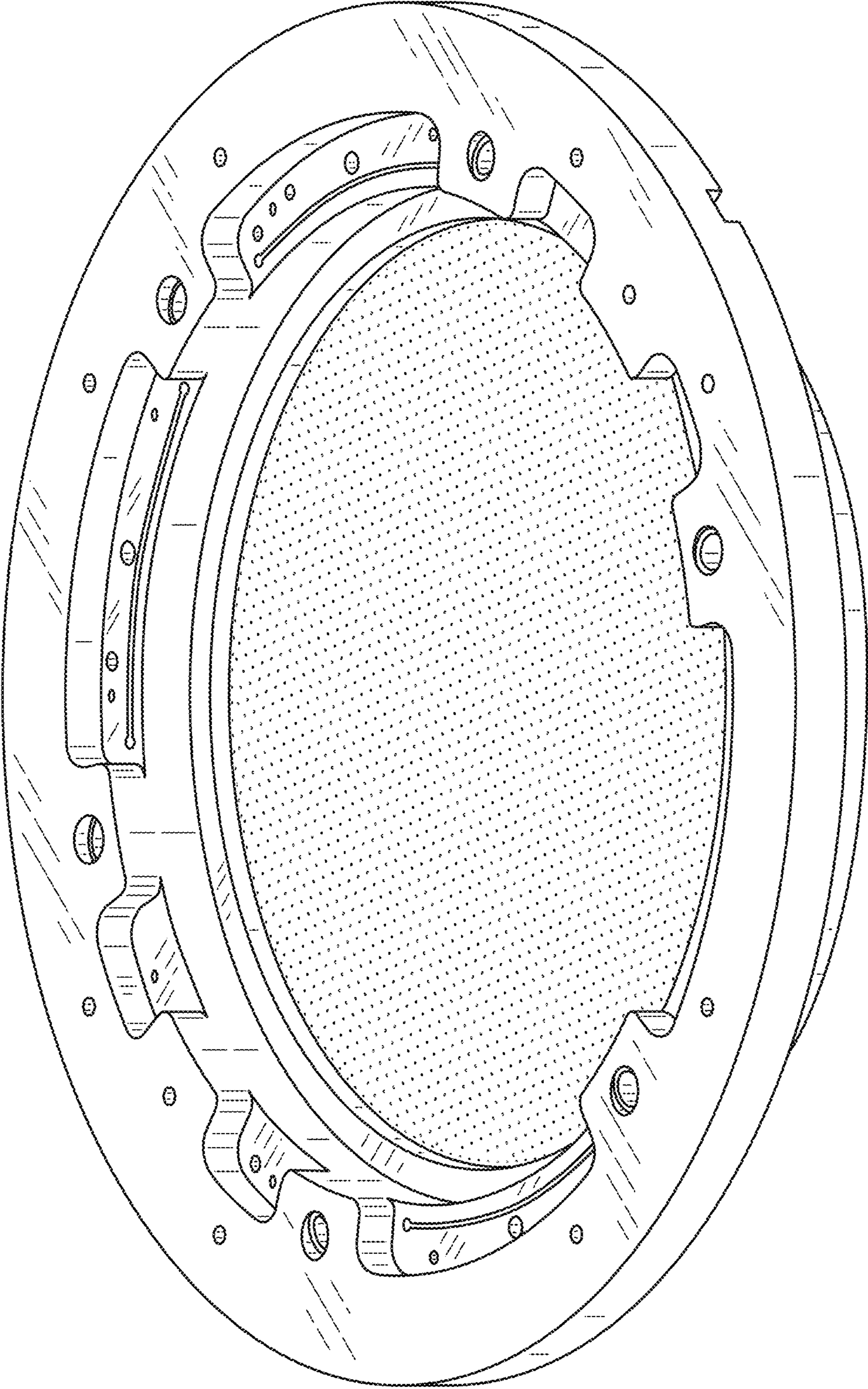

FIG.1

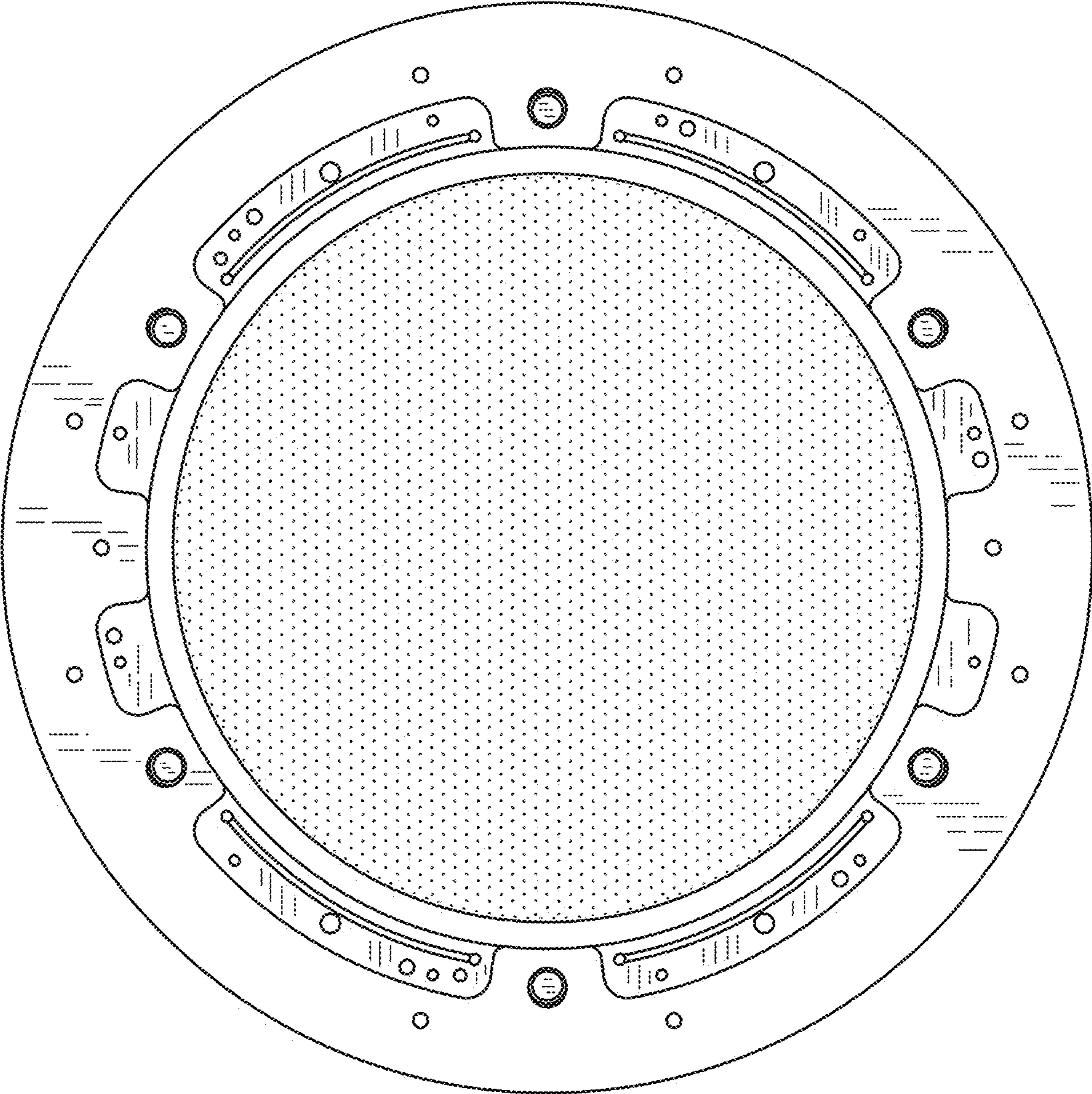

FIG.2

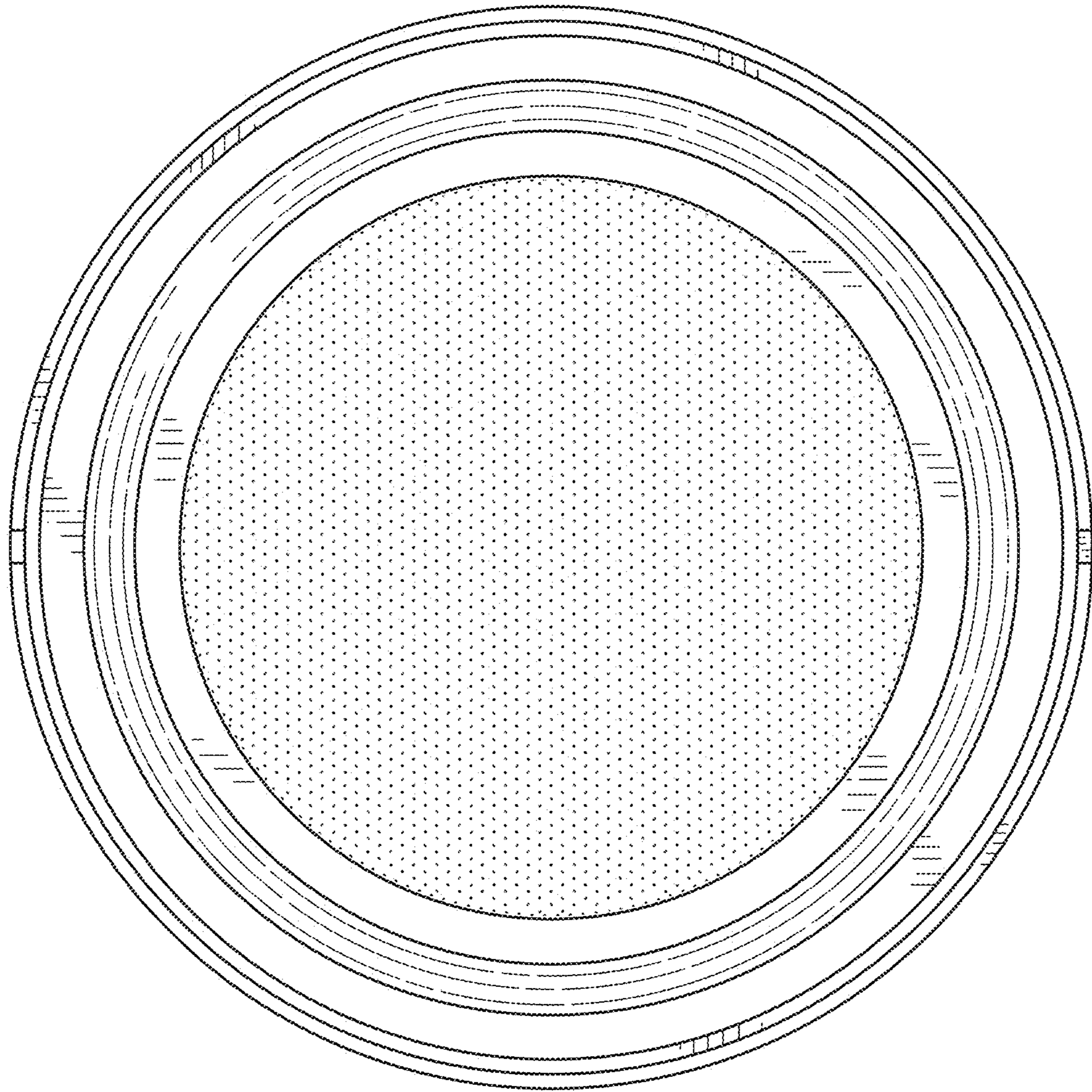

FIG.3

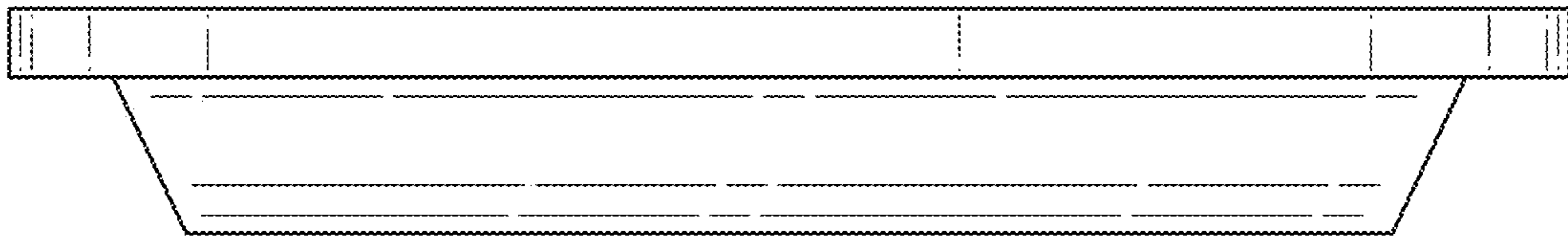

FIG. 4

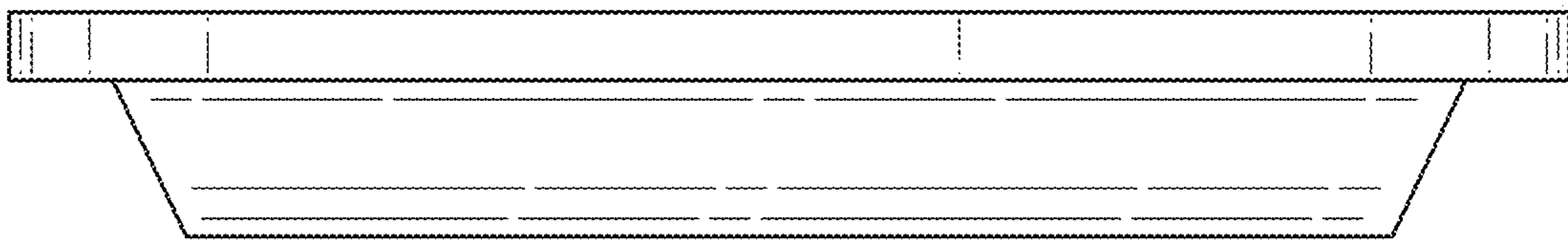

FIG. 5

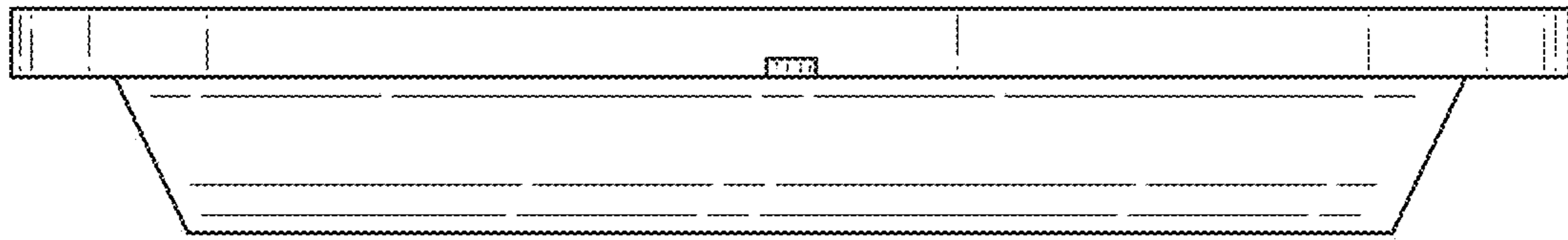

FIG. 6

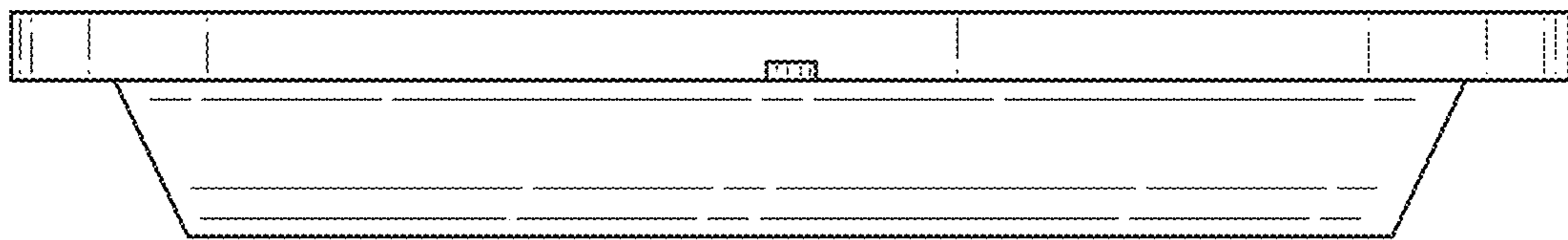

FIG. 7

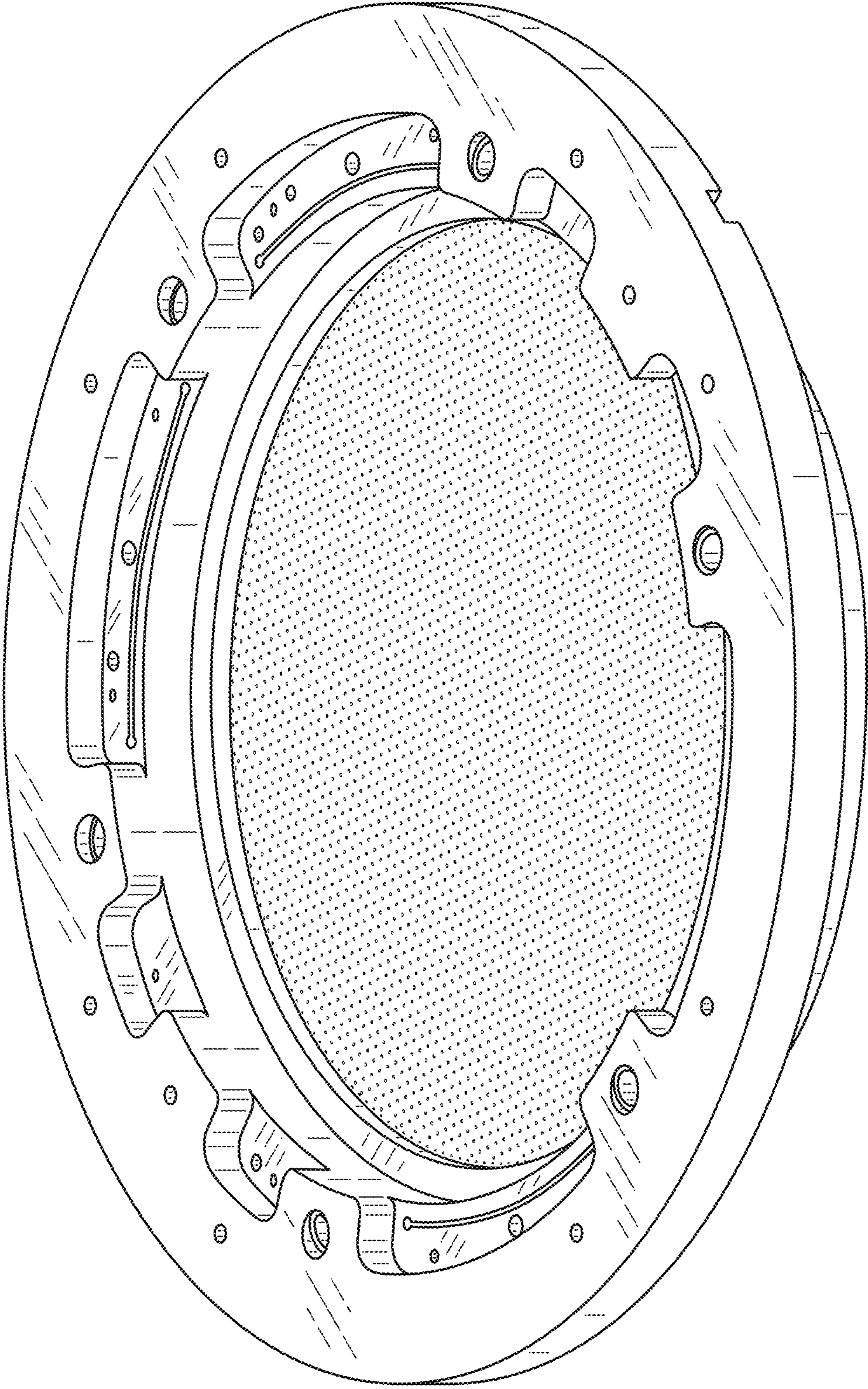

FIG. 8

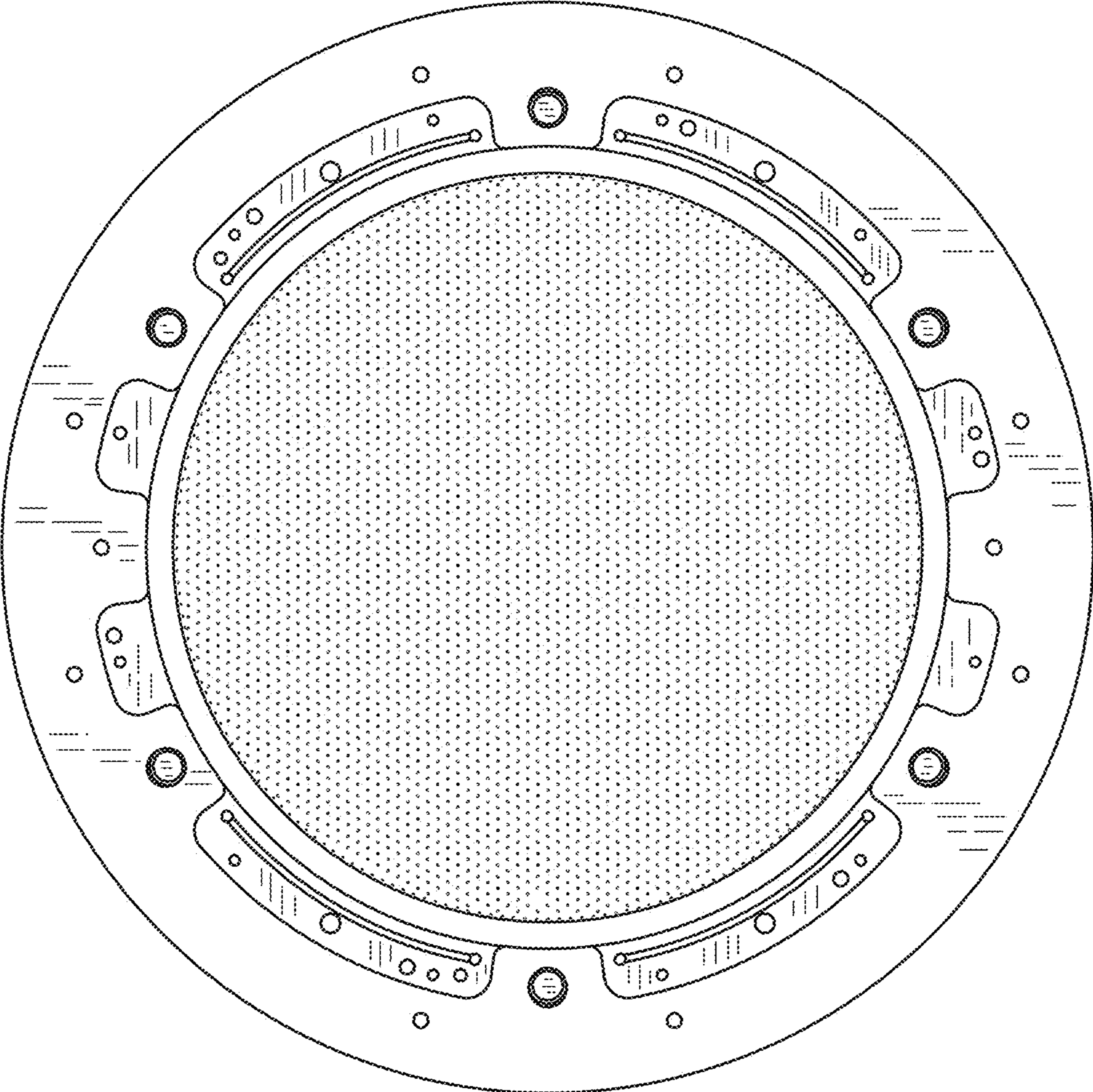

FIG.9

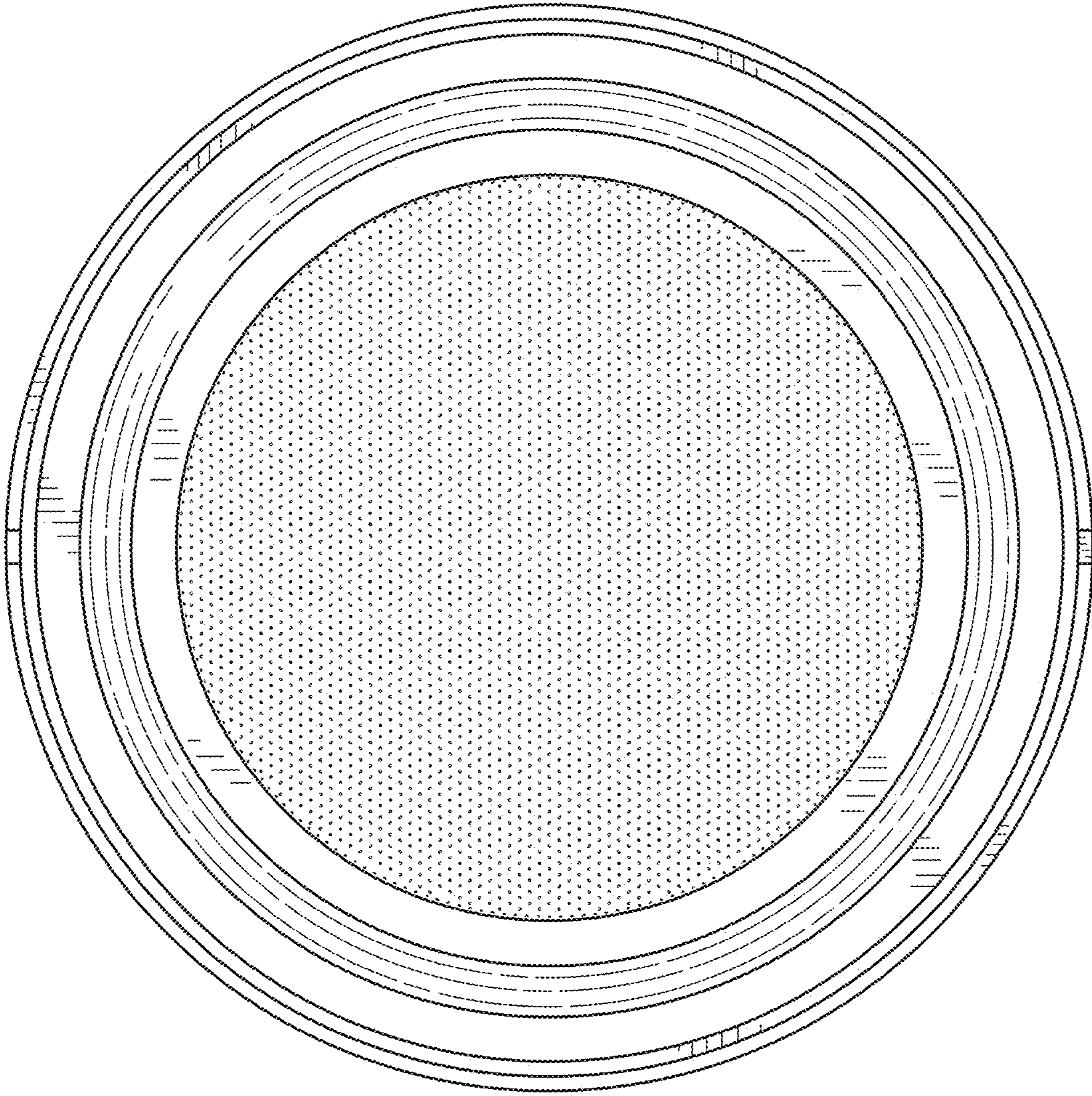

FIG. 10



FIG. 11

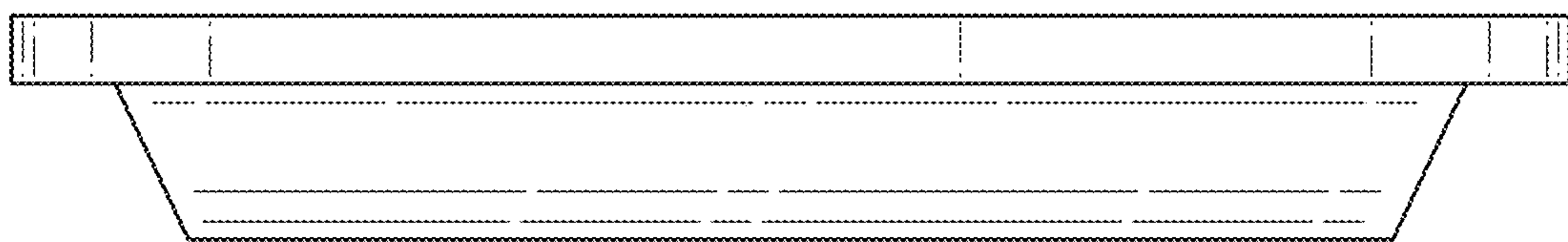

FIG. 12

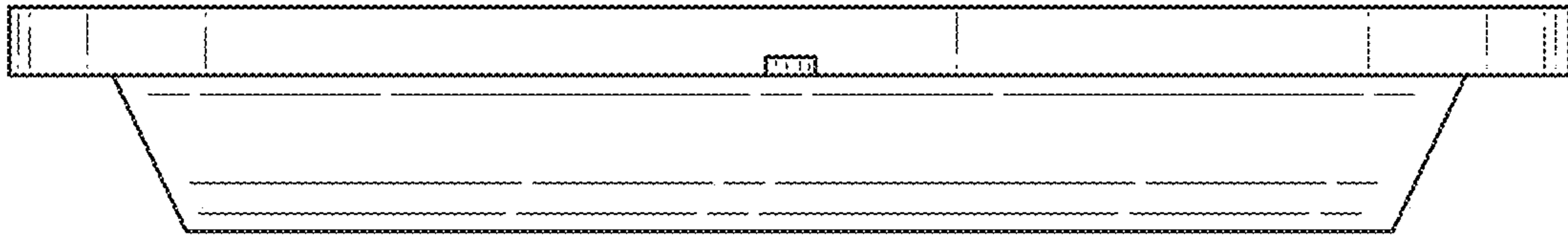

FIG. 13

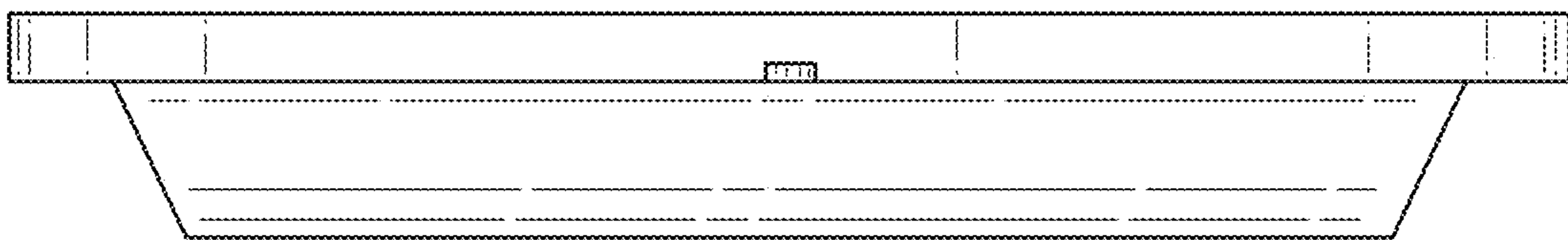

FIG. 14