



US00D944872S

(12) **United States Design Patent** (10) **Patent No.:** **US D944,872 S**
Di-Rosa et al. (45) **Date of Patent:** **** *Mar. 1, 2022**

(54) **FREEZER CABINET** D428,331 S * 7/2000 MacTavish D9/415
6,595,016 B1 * 7/2003 Demirkiran A01K 5/0114
62/236
(71) Applicant: **Conopco, Inc.**, Englewood Cliffs, NJ D484,150 S 12/2003 Becke
(US) 6,708,509 B1 * 3/2004 Senner F25C 5/005
62/137
(72) Inventors: **Vincenzo Di-Rosa**, Pomezia (IT); D615,858 S * 5/2010 Prevost D9/415
Matteo Franco, Casale Monferrato D675,020 S * 1/2013 Mu D3/302
(IT); **Varkey Bert Jacob**, Bedford D692,933 S 11/2013 Sorensen
(GB); **Marco Aristide Reposo**, D747,750 S 1/2016 Kim et al.
Monterra (IT); **Johannes Schulmeister**, D752,517 S * 3/2016 Scott D13/139.4
The Hague (NL) (Continued)

(73) Assignee: **Conopco, Inc.**, Englewood Cliffs, NJ
(US)

FOREIGN PATENT DOCUMENTS

EM 003303320-0002 7/2016

(*) Notice: This patent is subject to a terminal disclaimer.

OTHER PUBLICATIONS

(**) Term: **15 Years**

“Whynter ICM-200LS Automatic Ice Cream Maker 2 Quart [. . .]” [online], Whynter. [Product first available on Aug. 30, 2014], Retrieved from the Internet: <<https://www.amazon.com/dp/B00N63J432>>.*

(21) Appl. No.: **29/712,820**

“Top 5 Best Ice Cream Freezer 2019 and 2020” [online]. Top 5 Best. [Published on Aug. 25, 2019], Retrieved from the Internet: <<https://www.youtube.com/watch?v=bqzFYbwJKlc>>.*

(22) Filed: **Nov. 12, 2019**

AHT.
Algida.
ALPICOOL.
ArchiExpo Compact freezer.

(30) **Foreign Application Priority Data**

May 13, 2019 (EM) 006446670-0001

(Continued)

(51) **LOC (13) Cl.** **15-07**

(52) **U.S. Cl.**
USPC **D15/89**

(58) **Field of Classification Search**
USPC D15/79, 80, 81, 82, 83, 84, 85, 86, 87,
D15/88, 89, 90, 91; D9/414, 415, 420
CPC F25C 2400/10; F25D 2400/10; F25D
2400/12; F25D 2400/14; F25D 2400/18;
G05B 2219/2654; G09F 23/0058; Y10S
292/71

See application file for complete search history.

Primary Examiner — Mojtaba Tehrani

(74) *Attorney, Agent, or Firm* — Gerard J. McGowan, Jr.

(56) **References Cited**

U.S. PATENT DOCUMENTS

3,168,192 A * 2/1965 Nicholson B65D 5/5206
206/45.24
D288,938 S * 3/1987 Klodt D19/76

(57) **CLAIM**

The ornamental design for a freezer cabinet, as shown and described.

DESCRIPTION

FIG. 1 is a perspective view of our new design;
FIG. 2 is a front elevation view thereof;
FIG. 3 is a rear elevation view thereof;
FIG. 4 is a left side elevation view thereof;
FIG. 5 is a right side elevation view thereof;
FIG. 6 is a top plan view thereof; and,
FIG. 7 is a bottom plan view thereof.

1 Claim, 7 Drawing Sheets

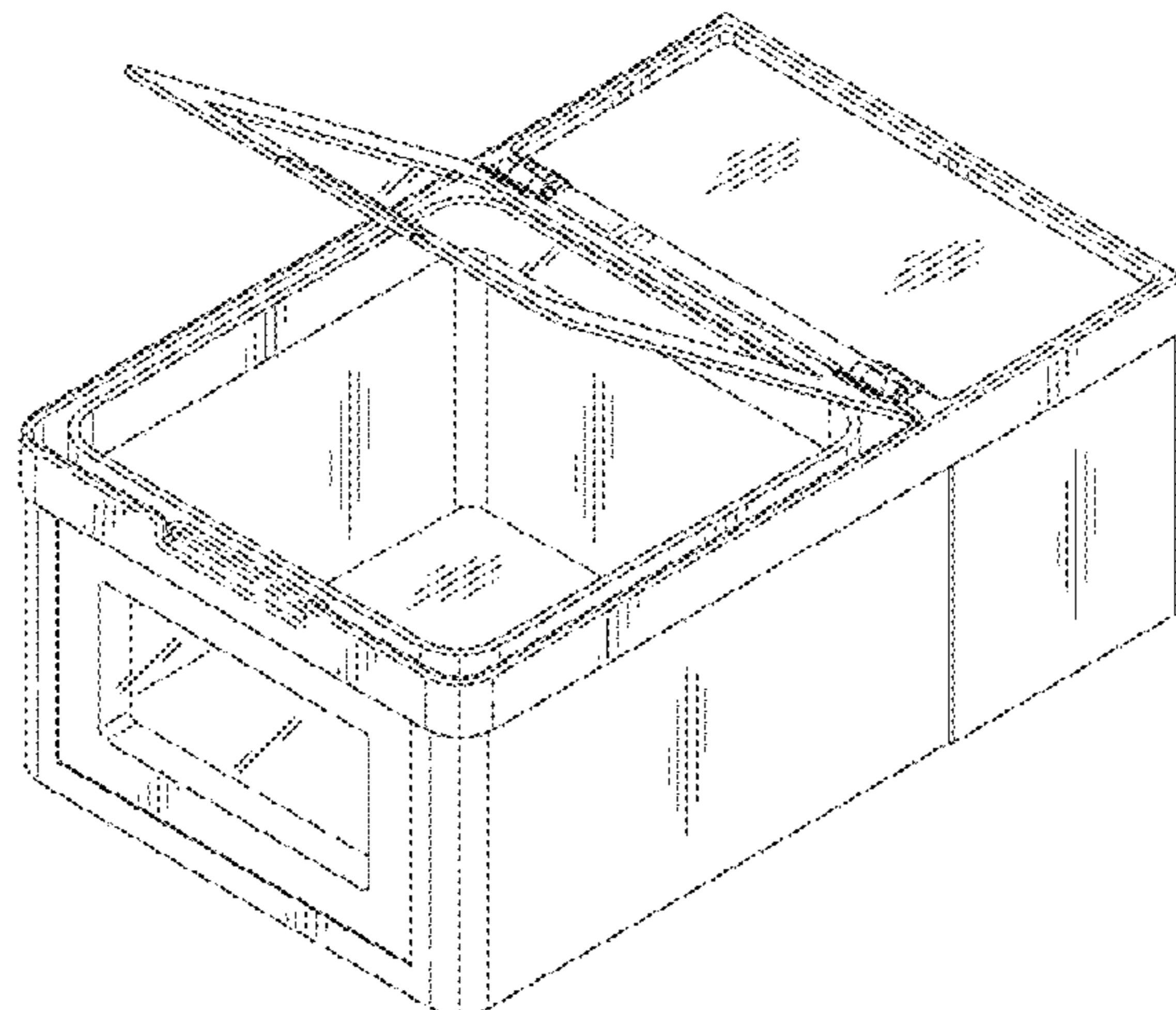

(56)

References Cited

U.S. PATENT DOCUMENTS

D761,646 S * 7/2016 Smith D9/414
D773,540 S 12/2016 Heck et al.
D776,985 S 1/2017 Kim
D785,056 S 4/2017 Lee et al.
D786,322 S 5/2017 Kim et al.
D790,609 S * 6/2017 Kim D15/89
D812,649 S 3/2018 Onrat
D823,356 S 7/2018 Lum et al.
D860,269 S * 9/2019 Britten D15/89
D860,270 S * 9/2019 Britten D15/89
D893,557 S * 8/2020 Lizier D15/79
D895,696 S * 9/2020 Buter D15/89
D898,083 S * 10/2020 Yao D15/79
D899,773 S * 10/2020 Hu D3/304
D907,073 S * 1/2021 Liu D15/79

OTHER PUBLICATIONS

Framec Mini Cream 2V Counter Top Scoop Ice Cream Display Freezer.
Gelatissimo F9 Counter Top Ice Cream Freezer, Goldline Industries.
Isotherm BI-53 Built-In Deep Freezer/Refrigerator.
Metalfrio.
Minifreezer.
Tecnocio Baby Counter Top Ice Cream Freezer, Advantage Commercial Kitchens.
Co-pending U.S. Appl. No. 29/712,818, entitled "Freezer Cabinet", filed Nov. 12, 2019.
Co-pending U.S. Appl. No. 29/658,838, entitled "Freezer Cabinet", filed Aug. 3, 2018.
Co-pending application entitled, "Freezer Cabinet".

* cited by examiner

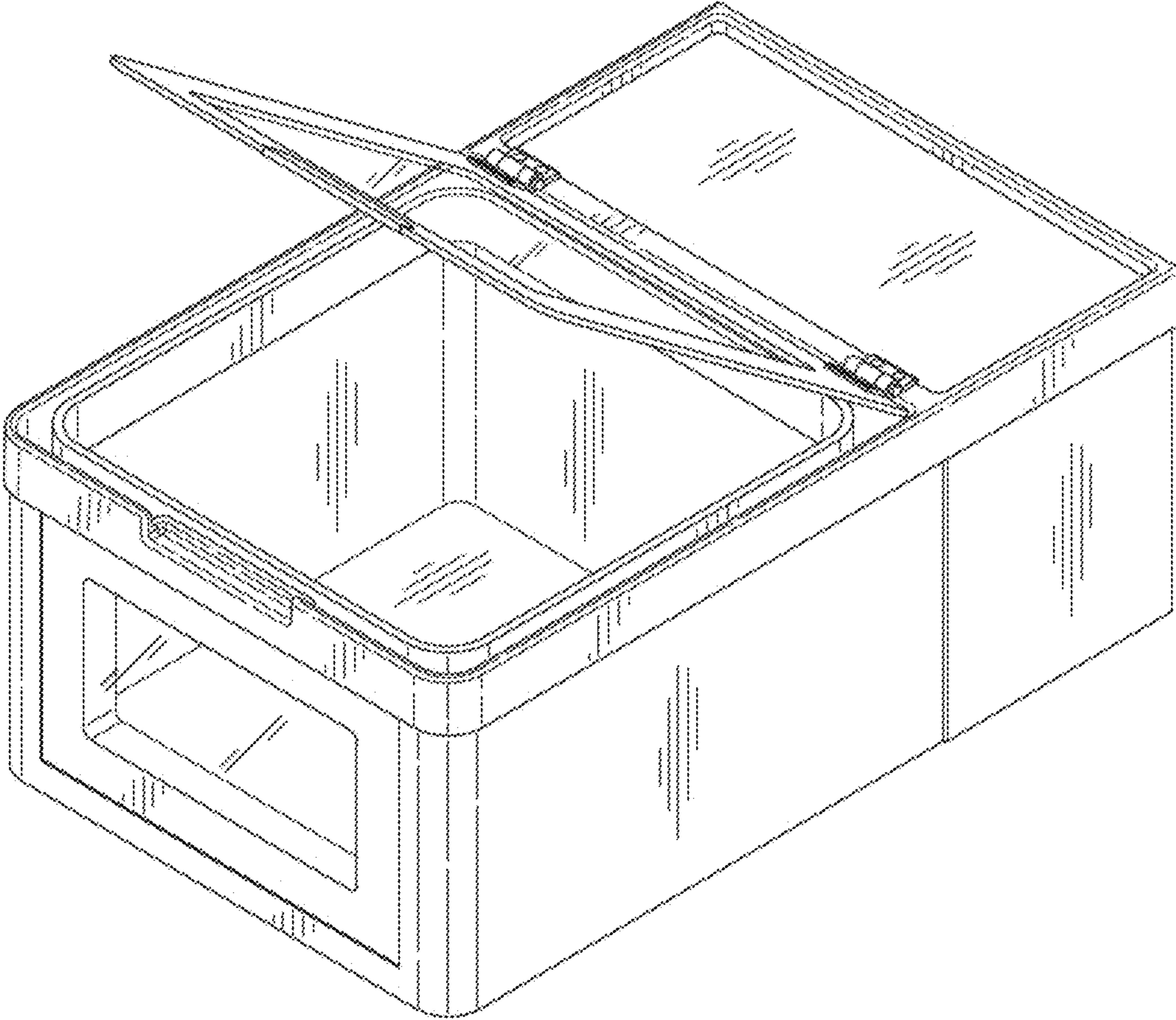

Fig. 1

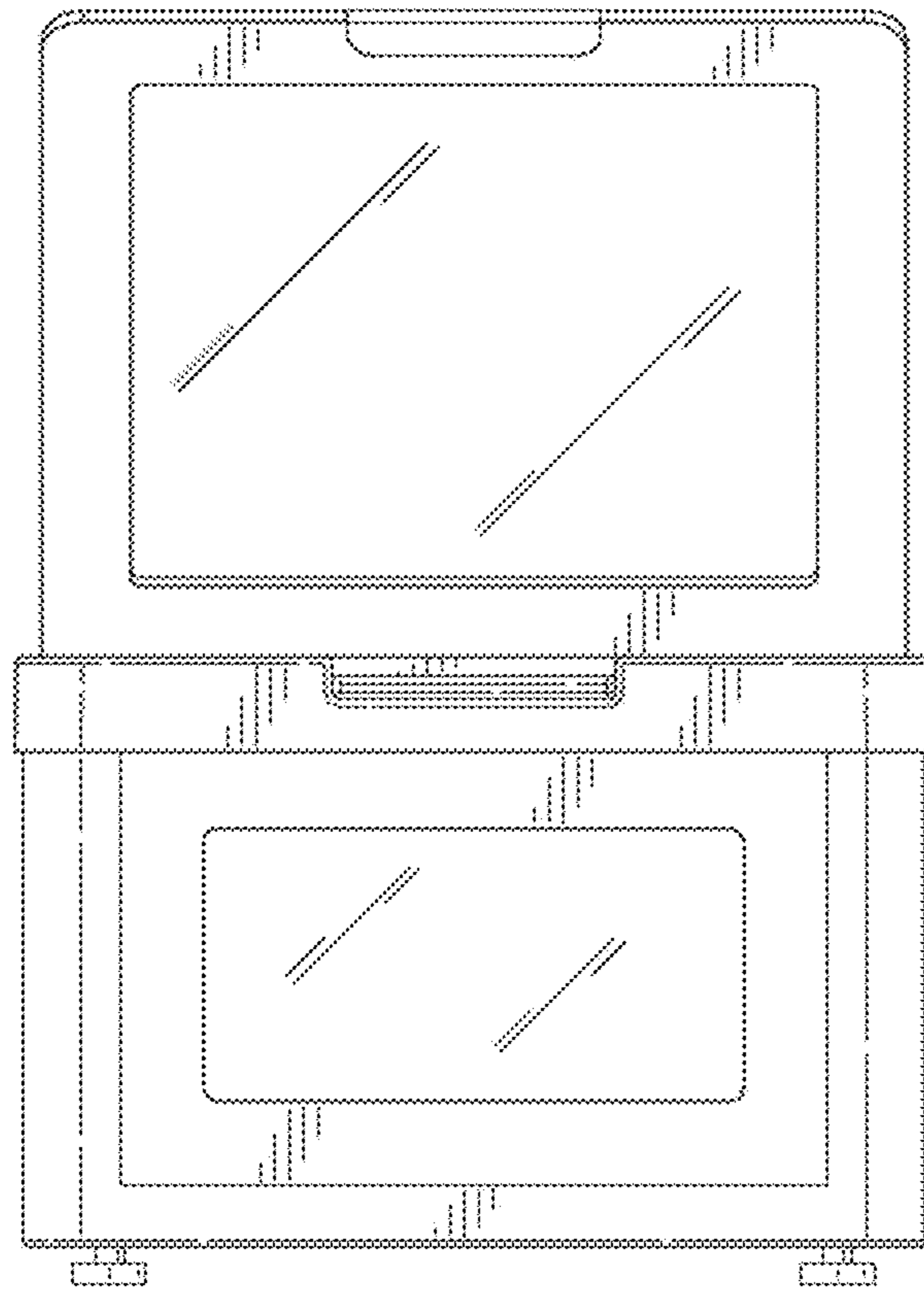

Fig. 2

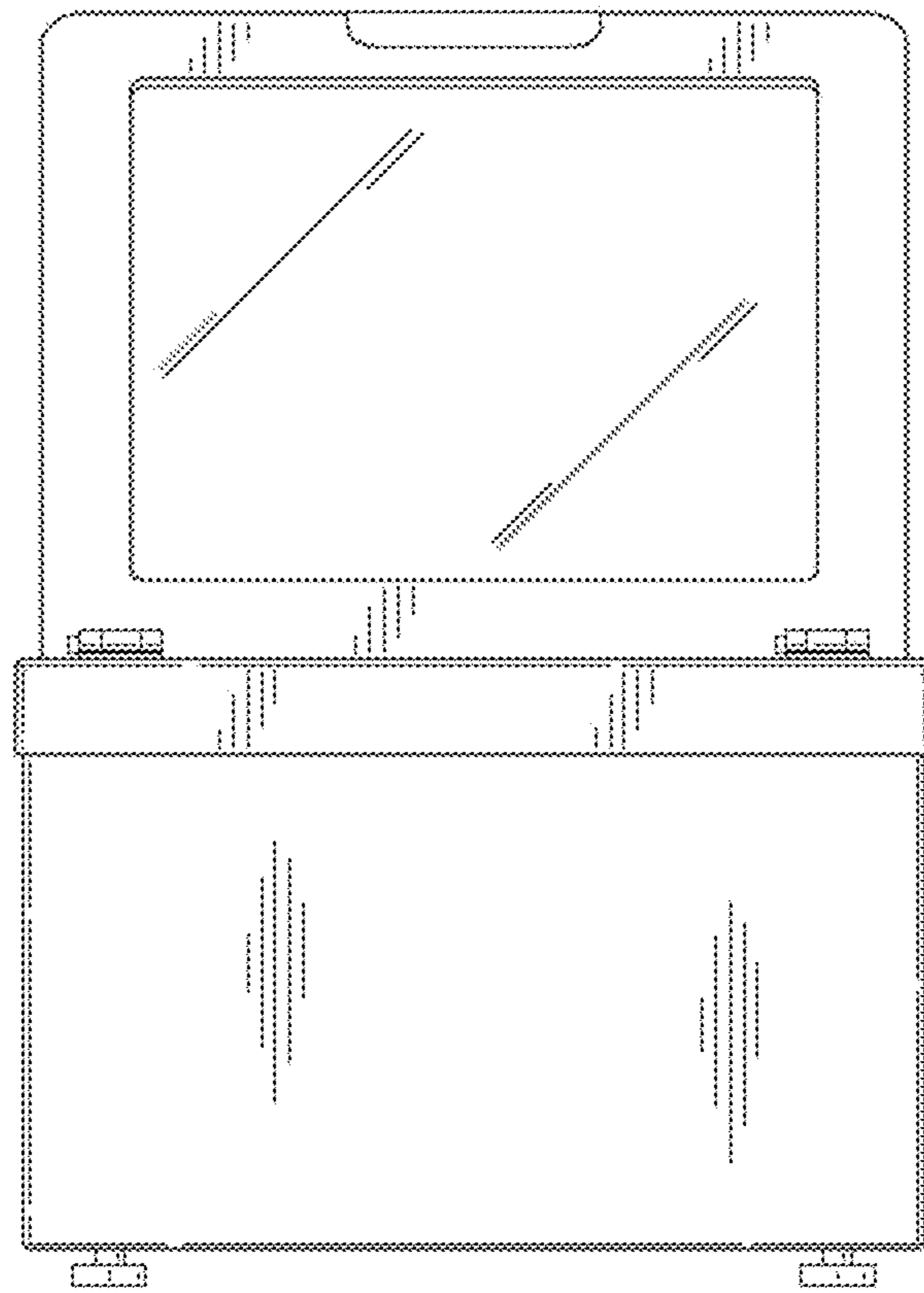

Fig. 3

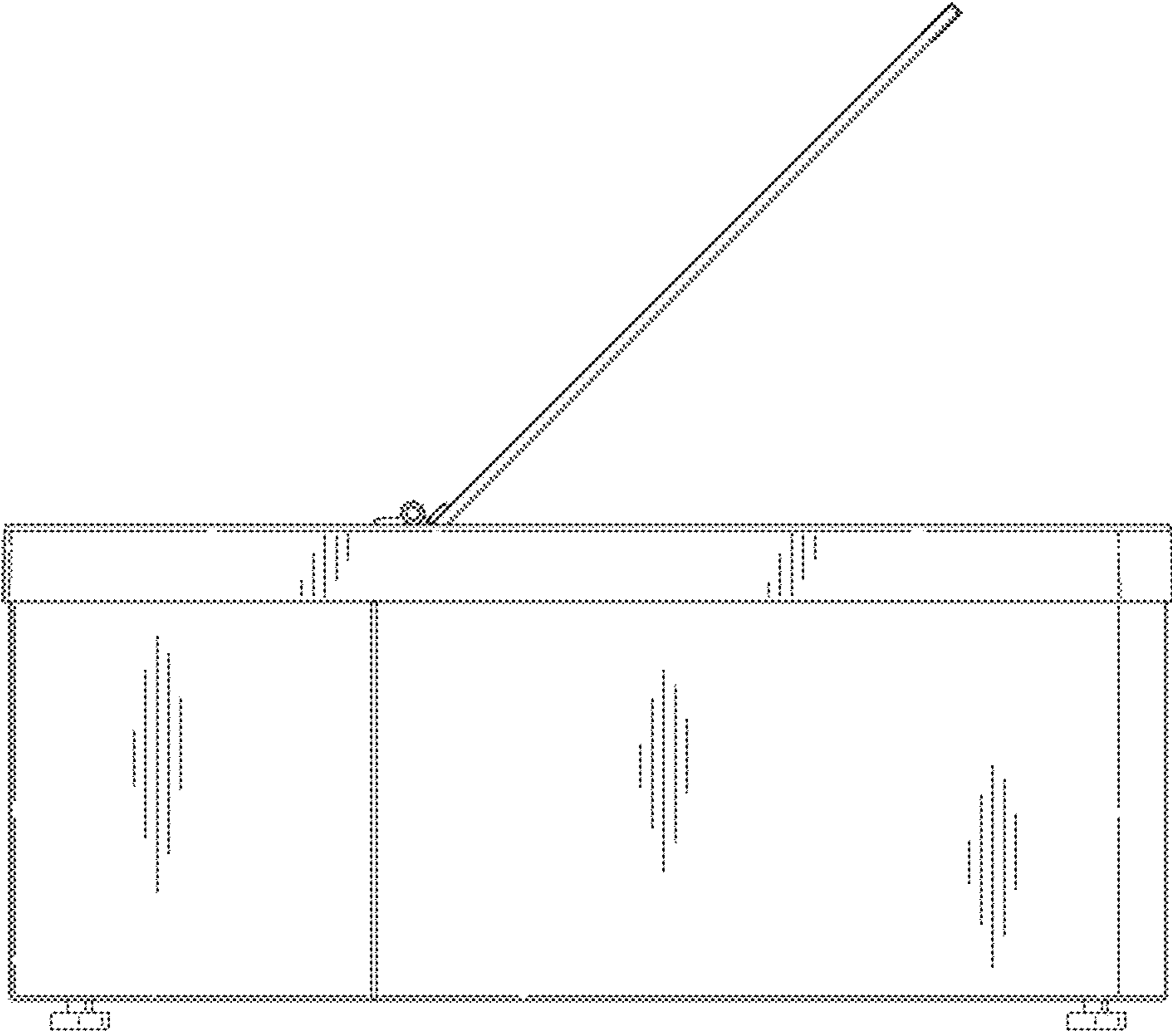

Fig. 4

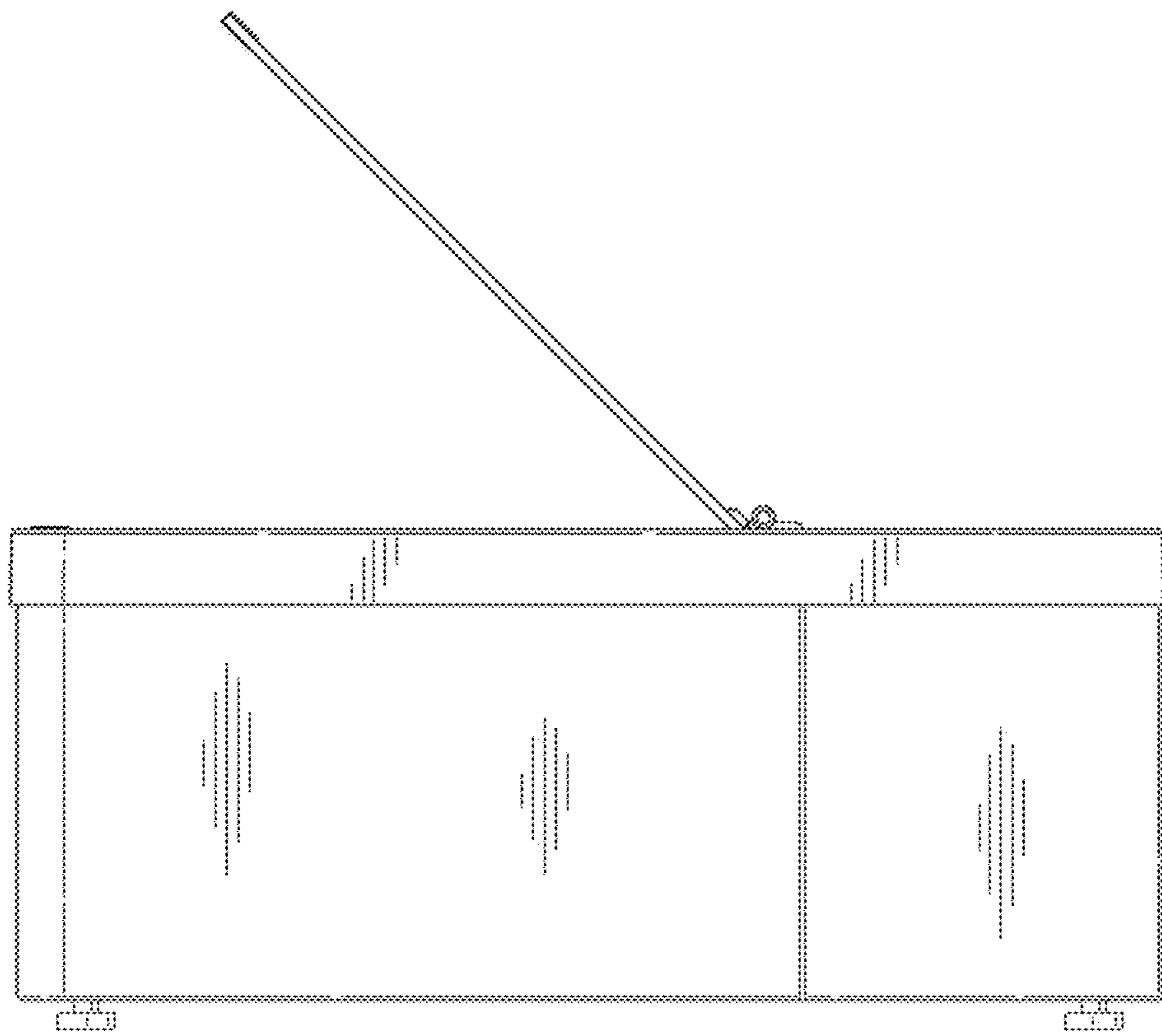

Fig. 5

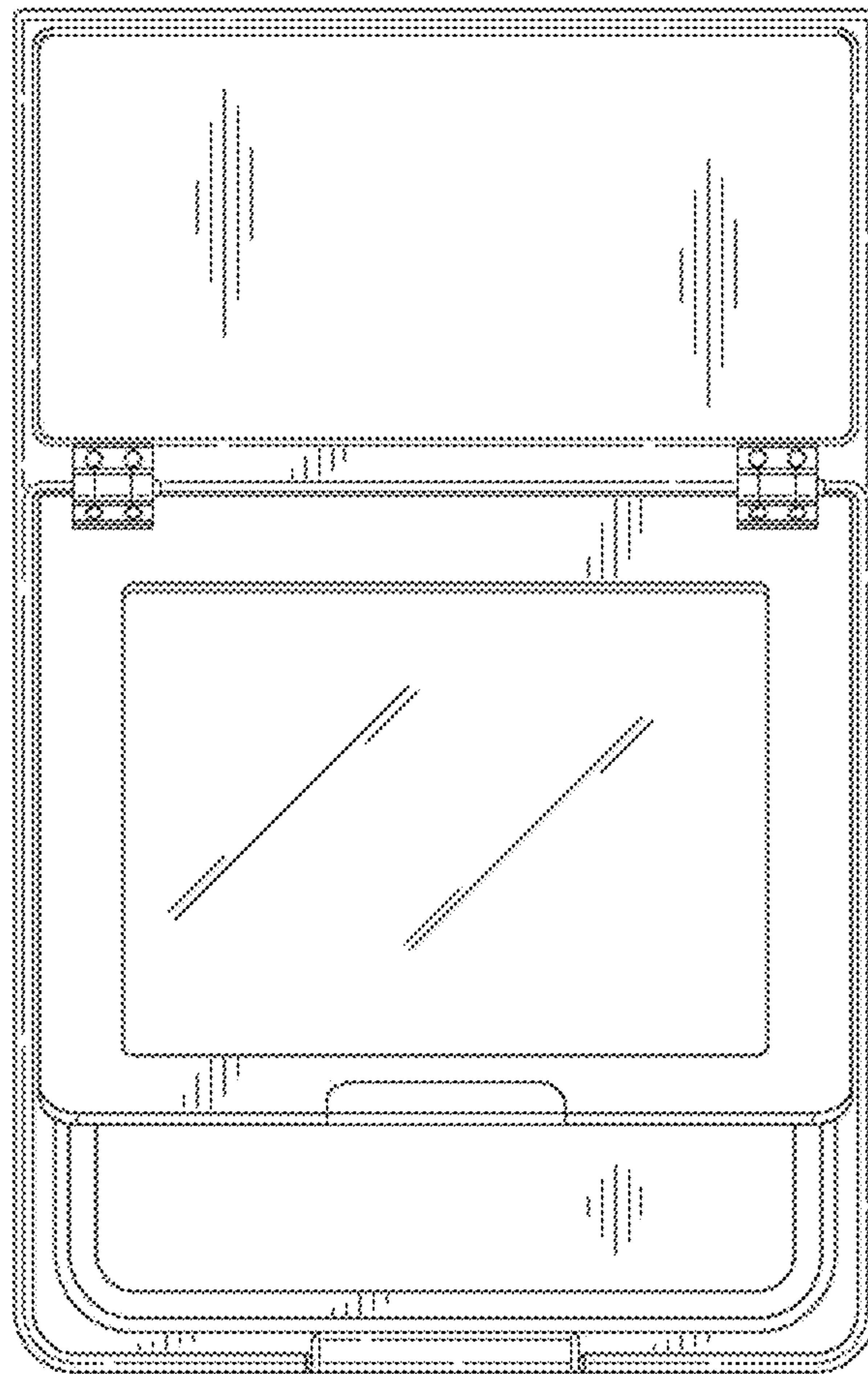

Fig. 6

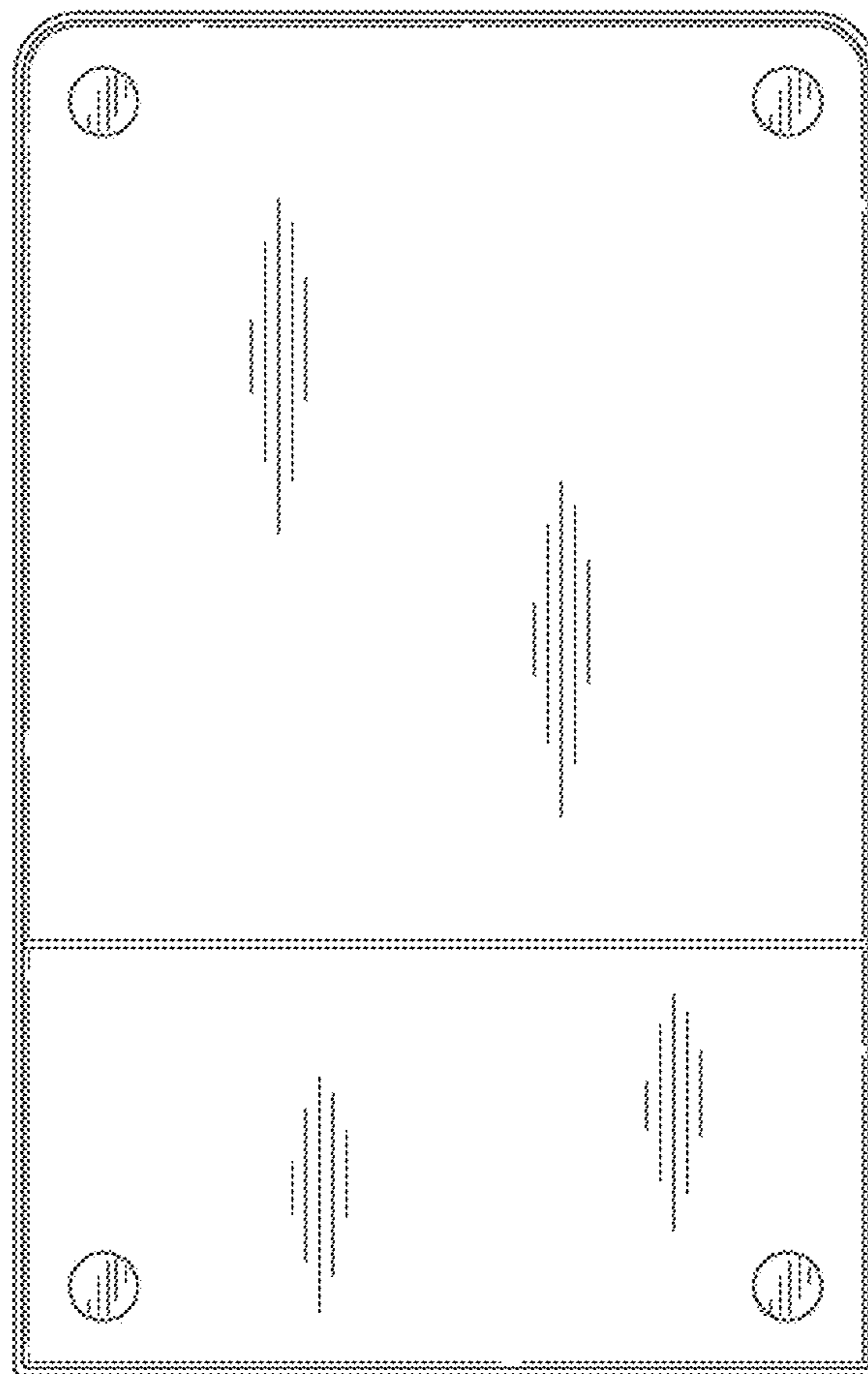

Fig. 7