

US00D944793S

(12) **United States Design Patent**
Bi et al.

(10) **Patent No.:** **US D944,793 S**
(45) **Date of Patent:** **** Mar. 1, 2022**

- (54) **STORAGE DEVICE**
- (71) Applicant: **Seagate Technology LLC**, Cupertino, CA (US)
- (72) Inventors: **Liying Bi**, Foster City, CA (US);
Ming-Hsueh Tsai, Taipei (TW);
Tommo Walter Brickner, San Francisco, CA (US)
- (73) Assignee: **Seagate Technology LLC**, Fremont, CA (US)
- (**) Term: **15 Years**
- (21) Appl. No.: **29/671,610**
- (22) Filed: **Nov. 28, 2018**
- (51) **LOC (13) Cl.** **14-02**
- (52) **U.S. Cl.**
USPC **D14/348**
- (58) **Field of Classification Search**
USPC D14/300-302, 308, 313-314, 348-370,
D14/383-385, 135, 155, 240-242,
D14/441-446, 188; D13/184, 199
CPC ... G11B 33/027; G11B 33/122; G11B 33/124;
G11B 33/022; G11B 33/025; G11B
33/02; G06F 1/16; G06F 1/20; G06F
1/181; G06F 1/187; G06F 1/183; G06F
1/184; H05K 7/16; H05K 7/1424; H05K
7/20; H05K 5/0052; H05K 5/0086; H05K
5/00; H05K 5/0004; H05K 5/0243
See application file for complete search history.

- 9,429,494 B1 * 8/2016 Gustafson G01M 3/202
- D788,101 S 5/2017 Satzger et al.
- 9,818,454 B1 * 11/2017 Albrecht G11B 33/1466
- D808,963 S * 1/2018 Delpier D14/348
- D809,492 S * 2/2018 Moon D14/240
- (Continued)

OTHER PUBLICATIONS

LaCie Mobile Drive 5TB External Hard Drive, posted at Amazon, first available date Apr. 3, 2019. Site visited Mar. 22, 2021. URL: <<https://www.amazon.com/LaCie-Mobile-Drive-External-Portable/dp/B07NY84719>> (Year: 2019).*

(Continued)

Primary Examiner — Kathleen L Jones

(74) *Attorney, Agent, or Firm* — Mueting Raasch Group

(57) **CLAIM**

The ornamental design for a storage device, as shown and described.

DESCRIPTION

FIG. 1 is a front, top perspective view of a storage device, showing our new design;
 FIG. 2 is a front elevation view of the design of FIG. 1;
 FIG. 3 is a rear elevation view of the design of FIG. 1;
 FIG. 4 is a right side elevation view of the design of FIG. 1;
 FIG. 5 is a left side elevation view of the design of FIG. 1;
 FIG. 6 is a top plan view of the design of FIG. 1; and,
 FIG. 7 is a bottom plan view of the design of FIG. 1.

The figures show a symbolic break in length of the storage device. The break lines, as well as any portion of the article between the break lines, form no part of the claimed design. The dash-dash broken lines illustrating portions of the article form no part of the claimed design. The dot-dash broken lines illustrate a boundary of the claimed design and form no part thereof.

1 Claim, 7 Drawing Sheets

- (56) **References Cited**
U.S. PATENT DOCUMENTS
- D606,034 S 12/2009 Suzuki
- D689,859 S 9/2013 Kurata
- D694,234 S 11/2013 McParland et al.
- D705,782 S 5/2014 McParland et al.

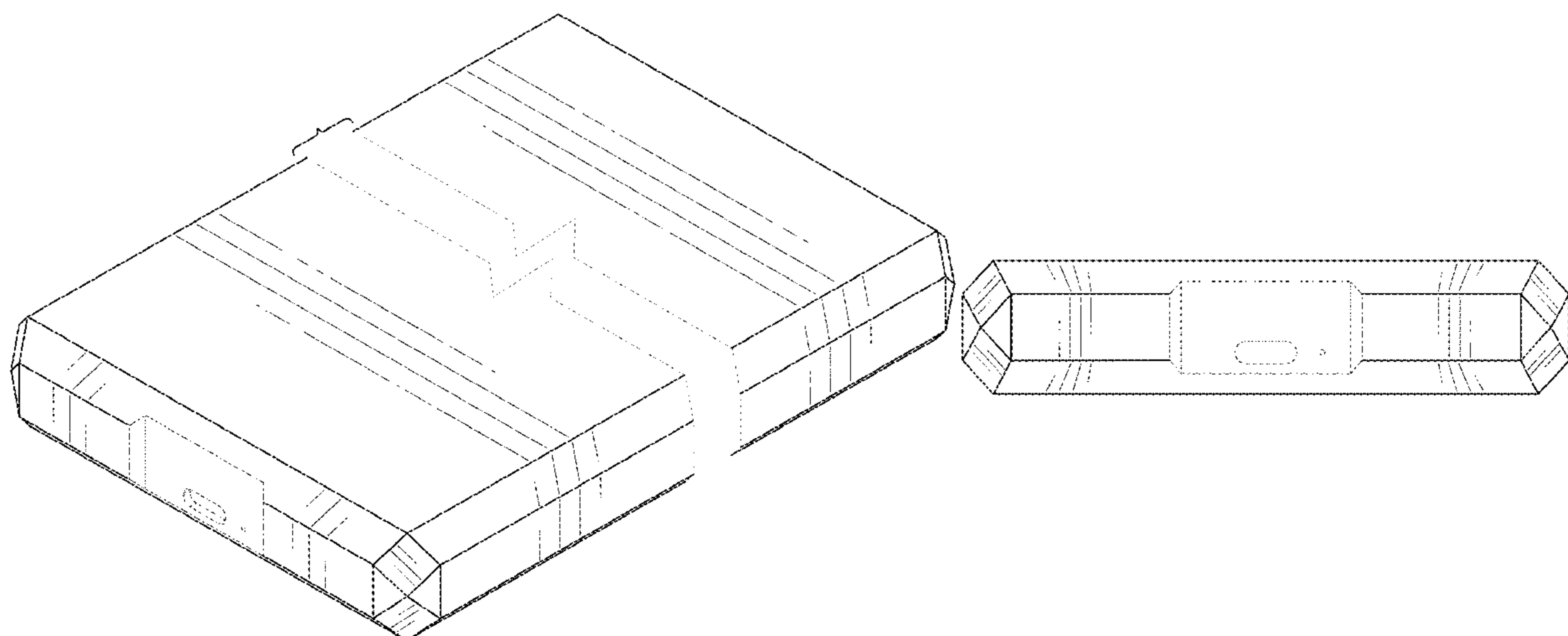

(56)

References Cited

U.S. PATENT DOCUMENTS

D811,377	S	*	2/2018	Wang	D14/240
D813,209	S	*	3/2018	Johnson	D14/230
D819,022	S		5/2018	Shim		
D821,995	S		7/2018	Wang		
D824,901	S		8/2018	Wu et al.		
D829,719	S		10/2018	Shim		
D832,837	S	*	11/2018	Pennington, Jr.	D14/348
D839,244	S	*	1/2019	Johnson	D14/230
D840,392	S		2/2019	Satzger et al.		
D843,998	S	*	3/2019	Bolotin	D14/365
D844,560	S		4/2019	Miller et al.		
D844,604	S	*	4/2019	Bolotin	D14/365
D856,327	S		8/2019	Huang		
D857,014	S		8/2019	Wu et al.		
D873,254	S	*	1/2020	Homza	D14/242
D873,820	S	*	1/2020	Wei	D14/348
D876,008	S		2/2020	Cheung		
D879,774	S		3/2020	Pennington, Jr. et al.		
10,615,552	B2		4/2020	Miller et al.		
D886,049	S	*	6/2020	Lee	D13/107
D889,449	S	*	7/2020	Abellera	D14/242
D899,421	S	*	10/2020	Deb	D14/313
D912,031	S	*	3/2021	He	D14/242

D912,656	S	*	3/2021	Hwang	D14/314
D913,213	S	*	3/2021	Bi	D13/103
2002/0043608	A1	*	4/2002	Nakata	G11B 33/124 248/560
2015/0153790	A1	*	6/2015	Ting	G11B 33/025 361/679.33
2017/0060195	A1	*	3/2017	Kim	G06F 1/182

OTHER PUBLICATIONS

Mirchandani, Varun, 10 Best External Hard Disks You Can Buy, posted at Beebom, posting date Jul. 2, 2018. Site visited Mar. 22, 2021. URL: <<https://beebom.com/best-external-hard-disks-2/>> (Year: 2018).*

Vazharov, Stefan, The Best External Hard Drives for Worry-Free Backups, posted at Best Products, posting date Oct. 31, 2017. Site visited Mar. 22, 2021. URL: <<https://www.bestproducts.com/tech/gadgets/g349/ssd-external-hard-drives/>> (Year: 2017).*

Btarunr, Sharkoon Announces QuickDeck Pro USB 3.0 HDD Dock, posted at TechPowerUp, posting date Nov. 8, 2011. Site visited Dec. 30, 2020. URL: <<https://www.techpowerup.com/154813/sharkoon-announces-quickdeck-pro-usb-3-0-hdd-dock/>> (Year: 2011).*

* cited by examiner

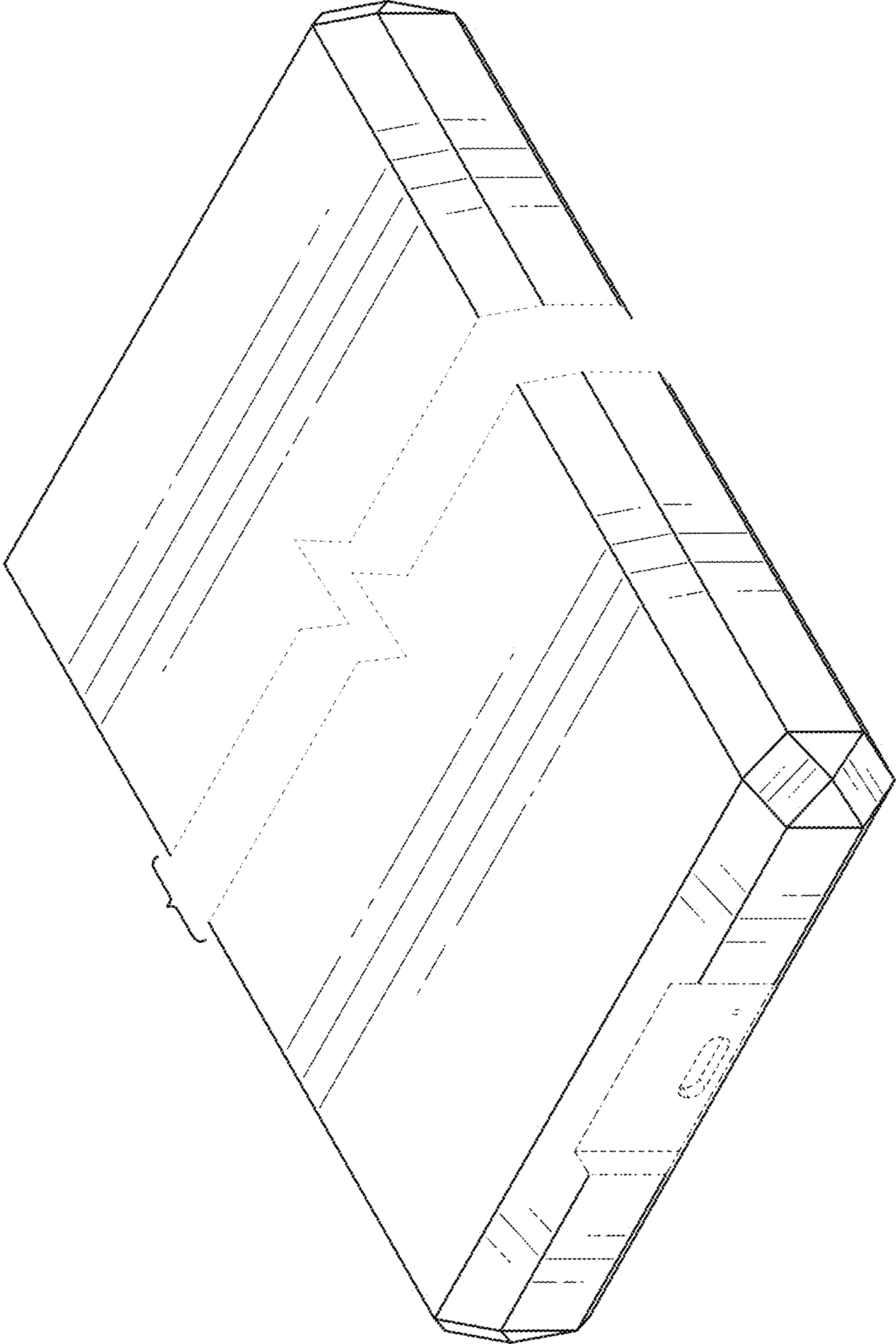

FIG. 1

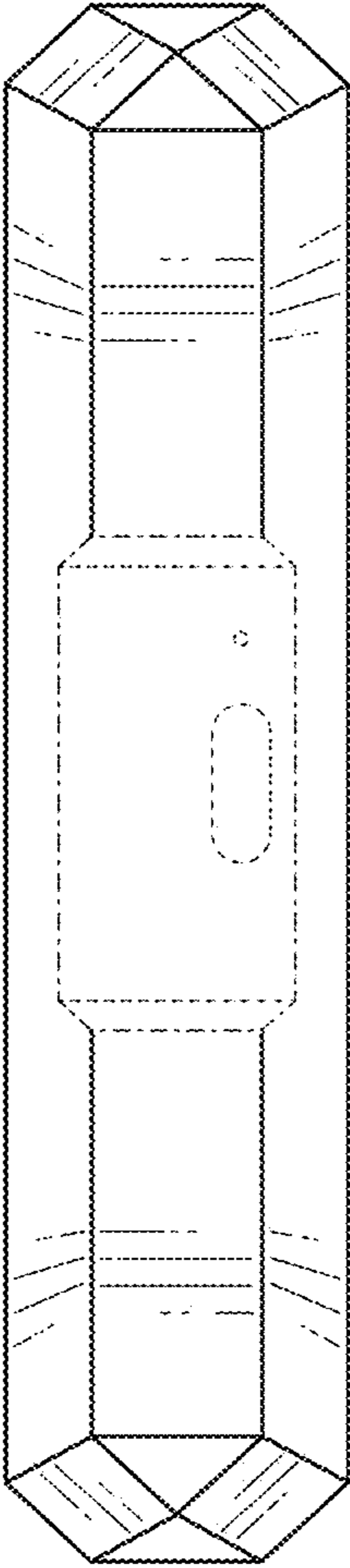

FIG. 2

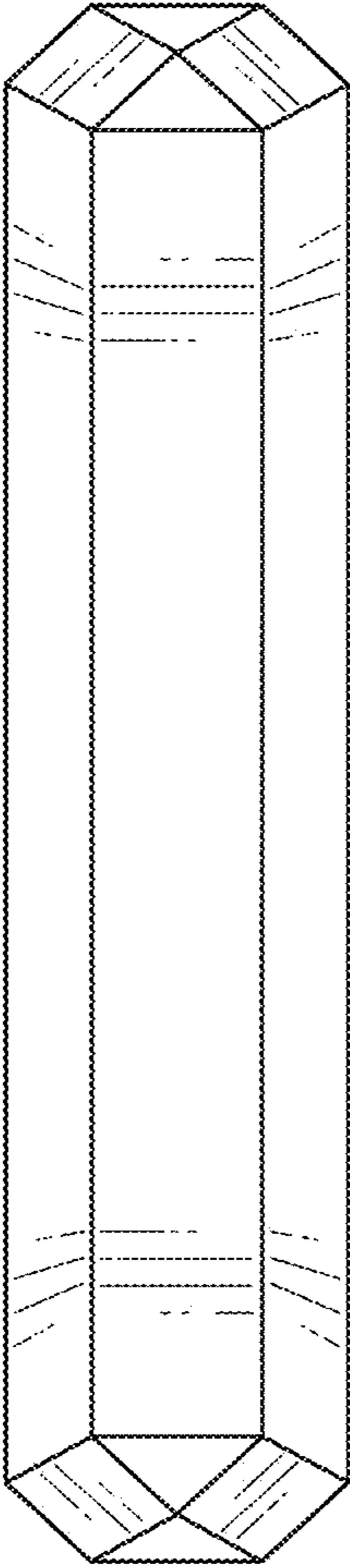

FIG. 3

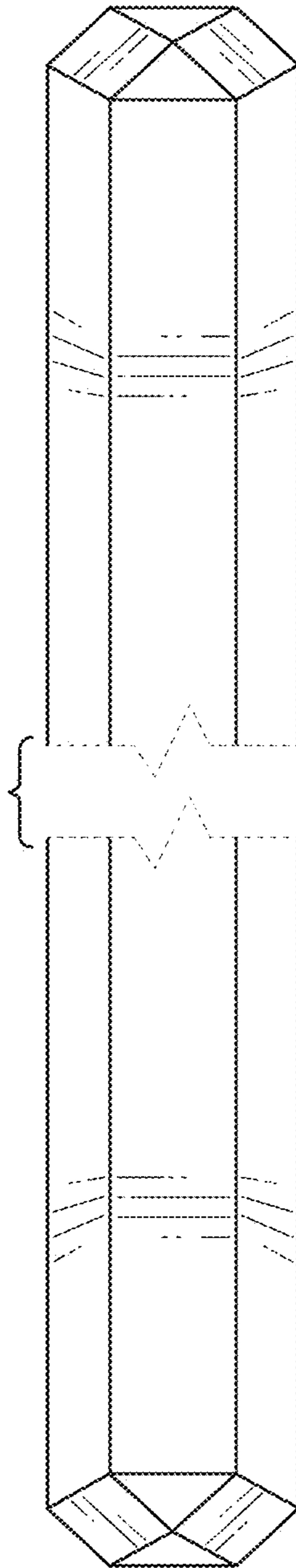

FIG. 4

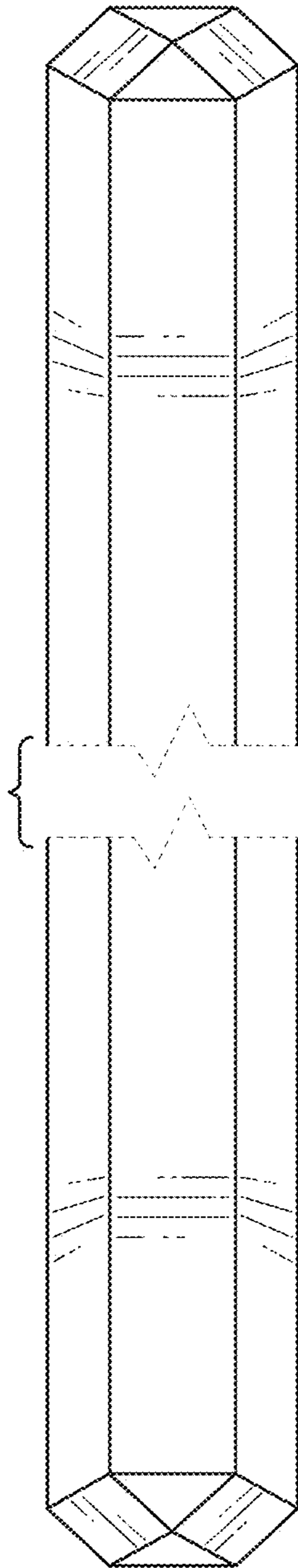

FIG. 5

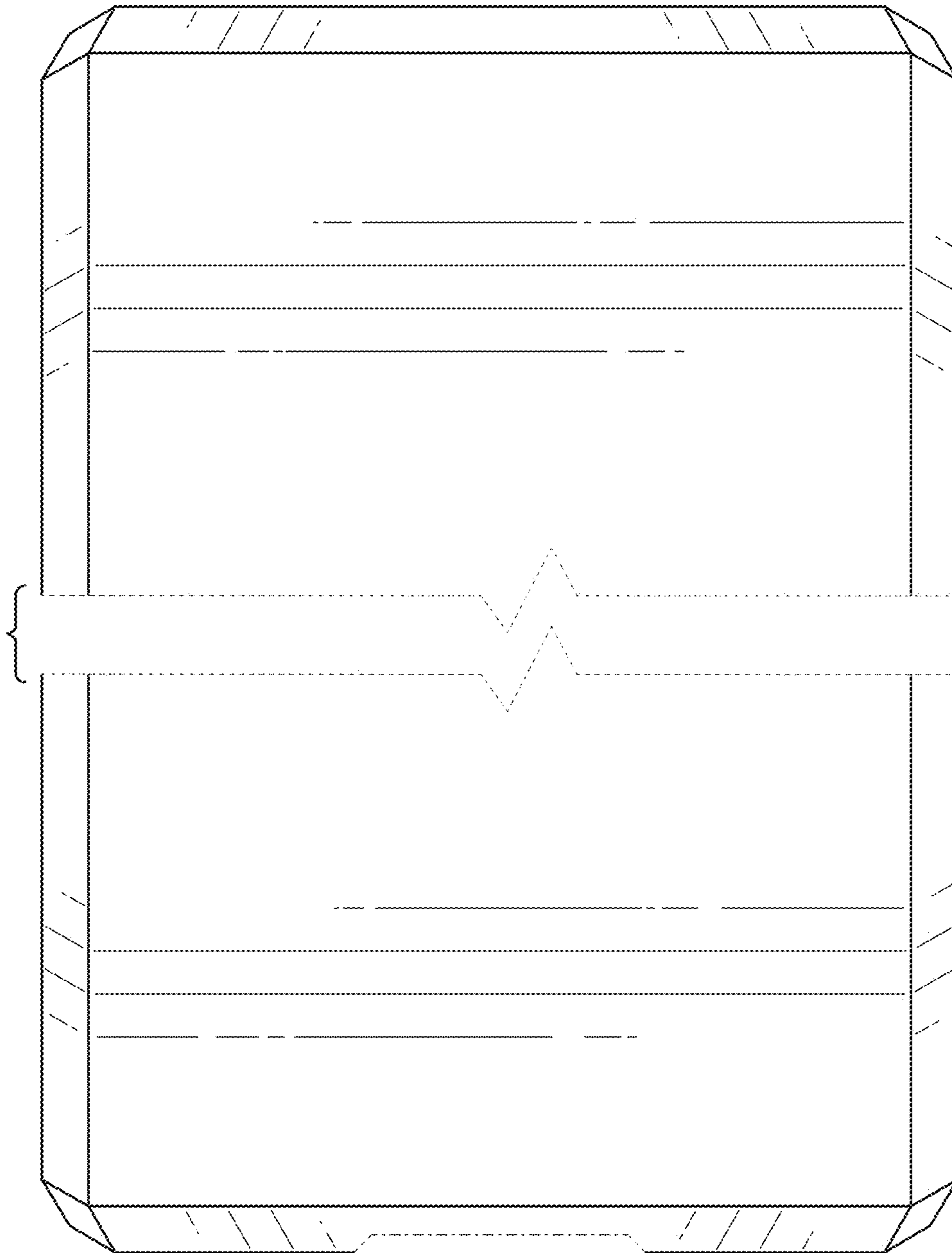

FIG. 6

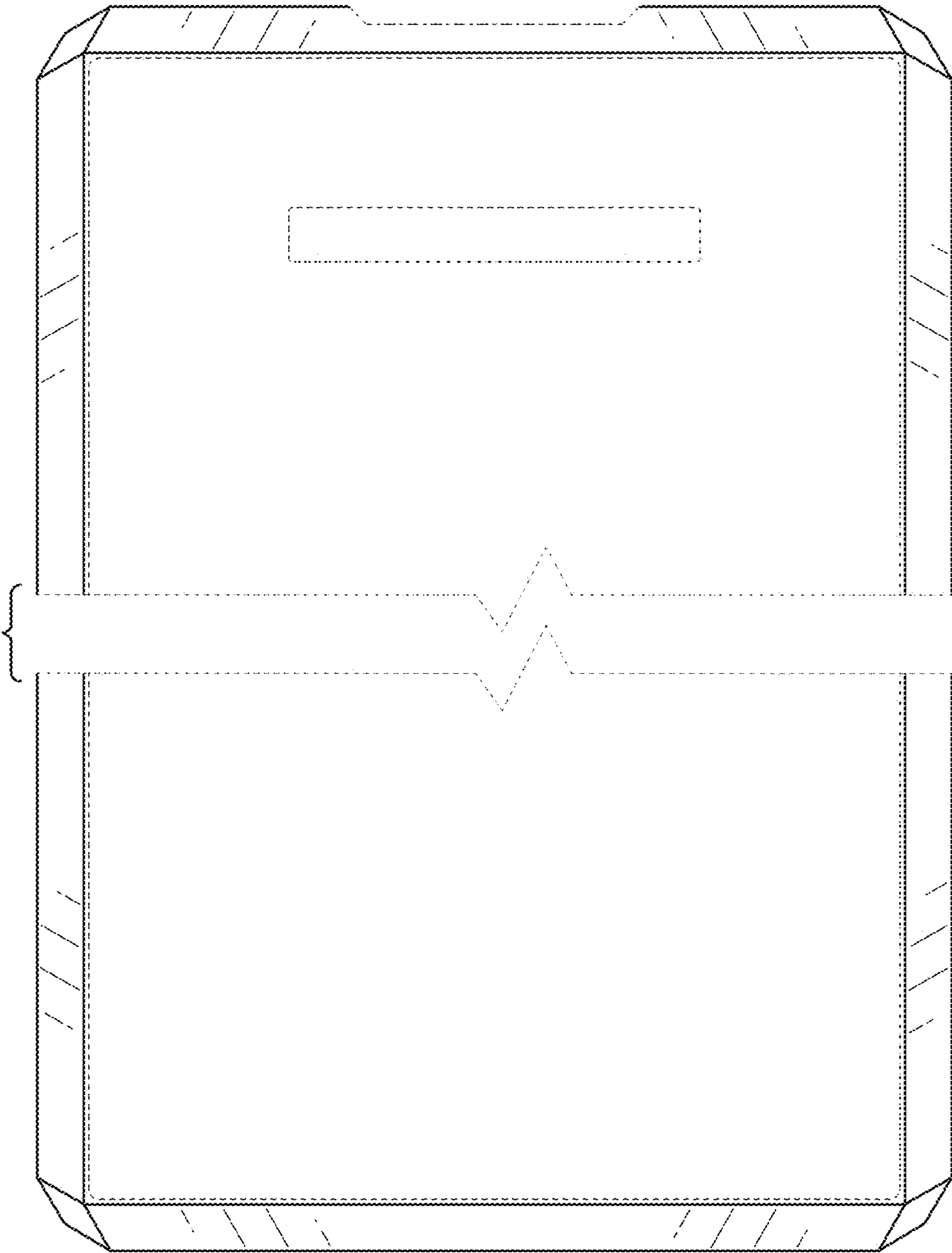

FIG. 7