



US00D944670S

(12) **United States Design Patent**
Qin et al.

(10) **Patent No.:** **US D944,670 S**
(45) **Date of Patent:** **** Mar. 1, 2022**

(54) **BODY FAT SCALE**

(71) Applicant: **ETEK CITY CORPORATION**,
Anaheim, CA (US)

(72) Inventors: **Zhiling Qin**, Shenzhen (CN); **Shipin Qin**, Shenzhen (CN)

(**) Term: **15 Years**

(21) Appl. No.: **29/734,590**

(22) Filed: **May 13, 2020**

(30) **Foreign Application Priority Data**

Nov. 13, 2019 (CN) 201930624903.0

(51) **LOC (13) Cl.** **10-04**

(52) **U.S. Cl.**
USPC **D10/91; D10/92**

(58) **Field of Classification Search**
USPC D10/83-96
CPC G01G 21/28; G01G 21/00; G01G 21/286;
G01G 21/30; G01G 23/3728; G01G
23/3735; G01G 19/44; G01G 3/14; G01G
19/46; G01G 19/48; G01G 19/50; G01G
21/44; G01G 19/414; G01G 19/4144;
G01G 19/42; G01G 23/166; F16F 1/123;
A61B 5/053; A61B 5/4872; A61B
5/0537; A61B 5/4869; A61B 5/6825;
A61B 5/6829; A61B 5/7445; A61B
5/1072; G06Q 20/3678; G06Q 20/387;
G06Q 20/065; G06Q 20/36; G06Q 20/06;
G06Q 20/208; G09B 19/00; G16H 20/00;
G16H 40/63

See application file for complete search history.

(56) **References Cited**

U.S. PATENT DOCUMENTS

D545,708 S * 7/2007 Kajimoto D10/92
D700,092 S * 2/2014 Ogihara D10/92
D718,162 S * 11/2014 Kobayakawa D10/92
D726,566 S * 4/2015 Ogihara D10/92

D798,175 S * 9/2017 Donovanick D10/92
D808,287 S * 1/2018 Liang D10/92
D820,133 S * 6/2018 Pena D10/94
D853,260 S * 7/2019 Wang D10/92
D873,688 S * 1/2020 Fu D10/92

(Continued)

FOREIGN PATENT DOCUMENTS

CN 304726567 * 4/2018
CN 305371182 * 4/2019

(Continued)

OTHER PUBLICATIONS

RENPHO Store, Body Fat Scale, Date first available Dec. 22, 2016, [online] retrieved 05/201/21, available from https://www.amazon.com/RENPHO-Bluetooth-Bathroom-Composition-Smartphone/dp/B01N1UX8RW/ref=psdc_344746011_t3_B07W4P2M8G (Year: 2016).*

(Continued)

Primary Examiner — Keli L Hill
Assistant Examiner — Sara S Sahneh
(74) *Attorney, Agent, or Firm* — Tsz Lung Yeung

(57) **CLAIM**

The ornamental design for a body fat scale, as shown and described.

DESCRIPTION

FIG. 1 is a perspective view of a body fat scale showing my new design;
FIG. 2 is a front view thereof
FIG. 3 is a rear view thereof;
FIG. 4 is a right side view thereof;
FIG. 5 is a left side view thereof;
FIG. 6 is a top view thereof; and,
FIG. 7 is a bottom view thereof.
The broken lines depict portions of the body fat scale that form no part of the claimed design.

1 Claim, 7 Drawing Sheets

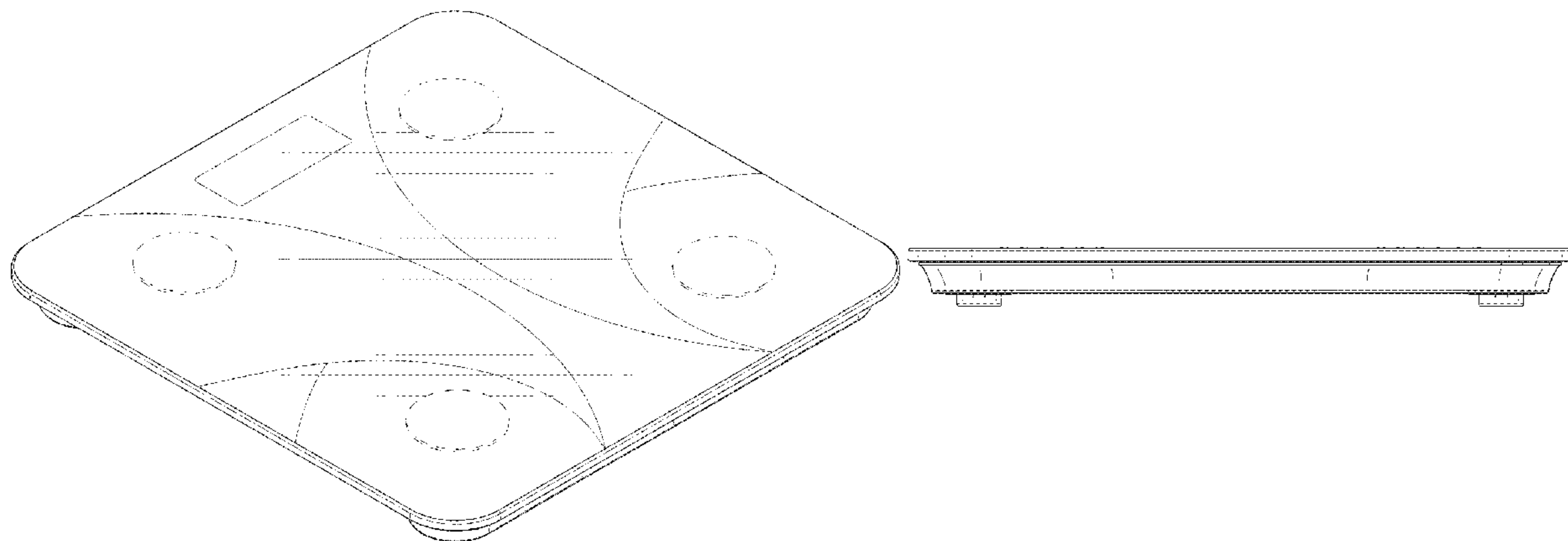

(56)

References Cited

U.S. PATENT DOCUMENTS

D883,118 S * 5/2020 Centen D10/91
D895,464 S * 9/2020 Wang D10/92
D897,226 S * 9/2020 Jiang D10/92
D912,554 S * 3/2021 Liu D10/92

FOREIGN PATENT DOCUMENTS

CN 305371183 * 4/2019
CN 306645528 * 3/2021
GB 9006588091-0003 * 6/2019
GB 6120264 * 2/2021
JP D1585240 * 10/2016

OTHER PUBLICATIONS

Posture,Scales for Body Weight,Date first available May 27, 2020,
[online]retrieved Jul. 20, 2021,available from https://www.amazon.com/dp/B08839L43J/ref=sspa_dk_detail_5?psc=1&pd_rd_i=B08839L43Jp13NParams&smid=AZN13EVO1927L&spLa=ZW5jcnlwdGVkUXVhbGlmaWVyPUEyTUVPU01YRVQoSjY1JmVuY (Year: 2020).*

Etekcitey Store, Smart Digital Bathroom Scale,Date first available Feb. 14, 2020, [online]retrieved Apr. 26, 2021,available from https://www.amazon.com/dp/B084SFL43F/ref=sspa_dk_detail_1?pd_rd_i=B084SFL43F&pd_rd_w=9v1SY&pf_rd_p=085568d9-3b13-4ac1-8ae4-24a26c00cb0c&pd_rd_wg=Y2eWZ&pf_rd_r=VK4BJQNQRHDWX28C6 (Year: 2020).*

SOKOA ,Smart Digital Scales,Date first available Jul. 28, 2020, [online]retrieved Apr. 26, 2021,available from https://www.amazon.com/dp/B08DRTZNZW/ref=sspa_dk_detail_5?psc=1&pd_rd_i=B08DRTZNZW&pd_rd_w=cTZ3i&pf_rd_p=085568d9-3b13-4ac1-8ae4-24a26c00cb0c&pd_rd_wg=3OSTG&pf_rd_r=F3KZEV2QE83PXNFE3XDA&pd_rd_r=22 (Year: 2020).*

* cited by examiner

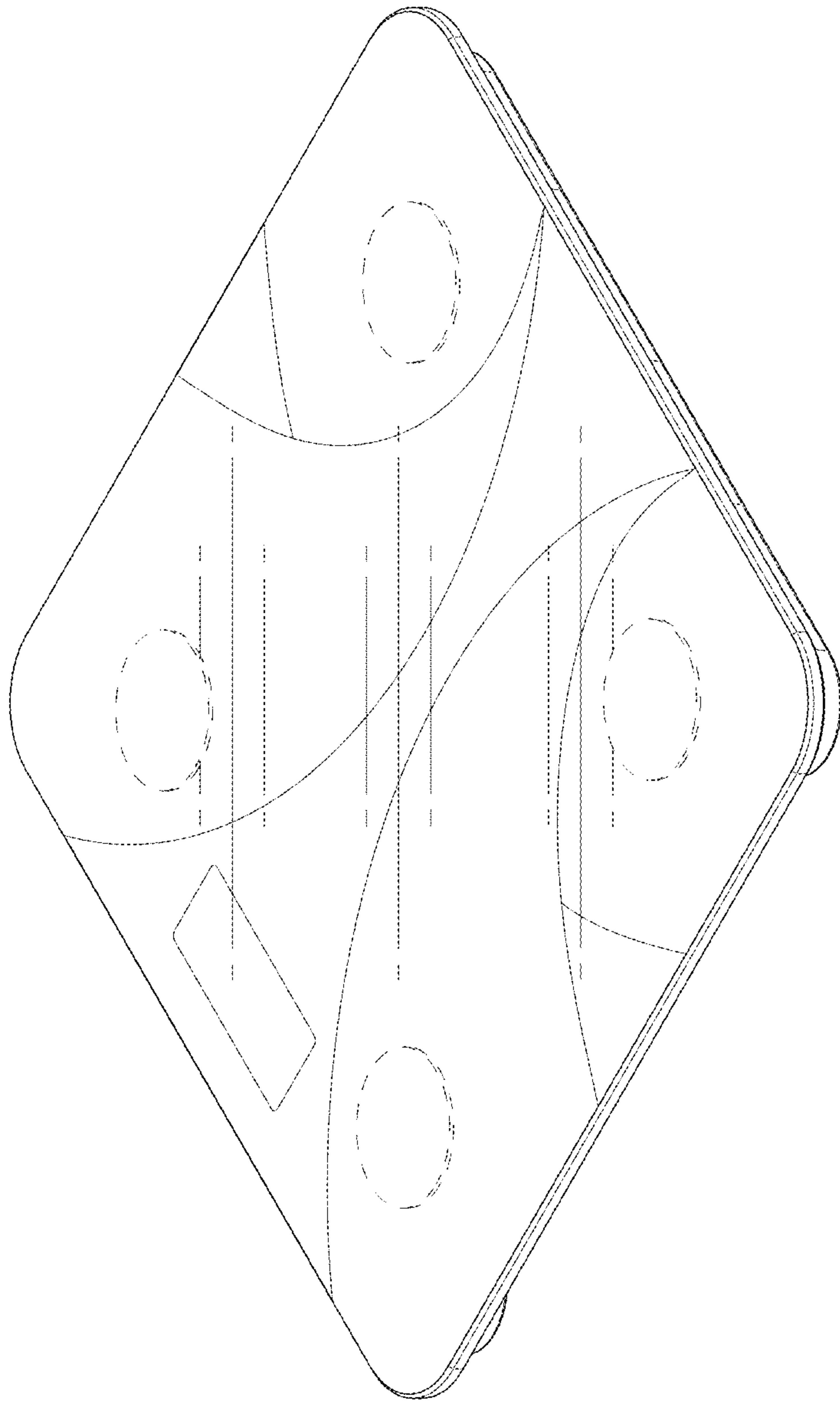

FIG. 1

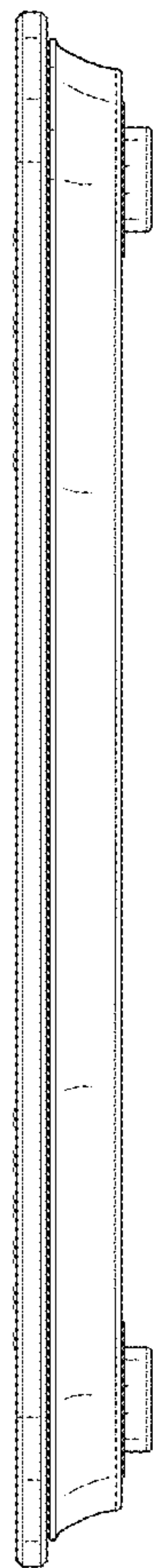

FIG. 2

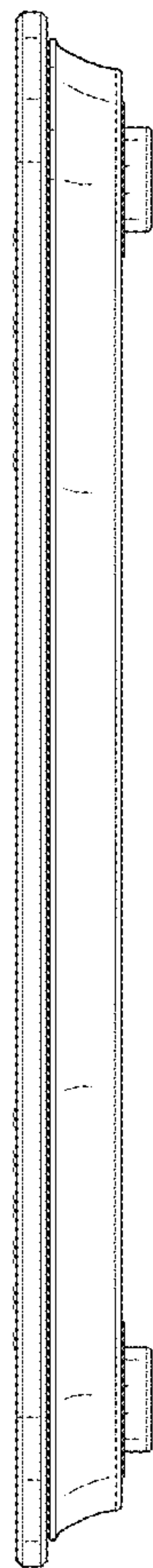

FIG. 3

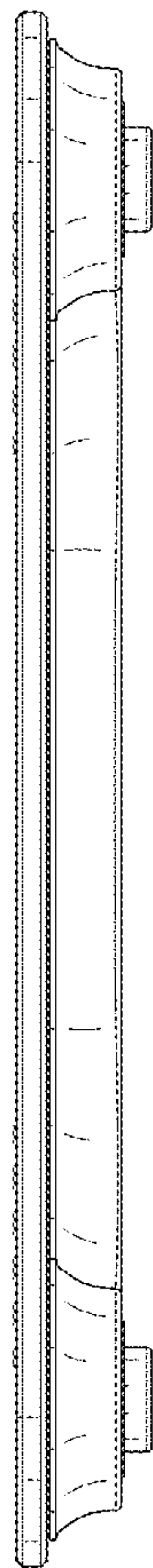

FIG. 4

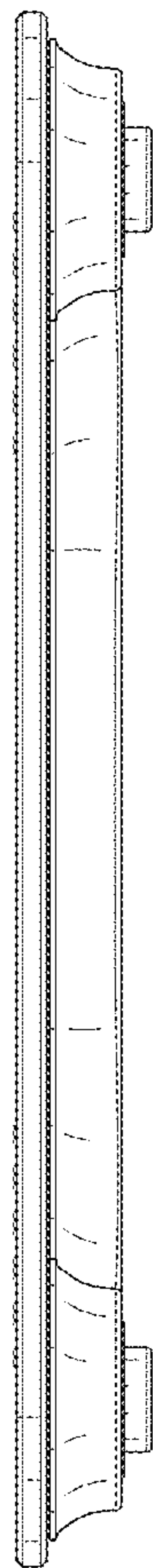

FIG. 5

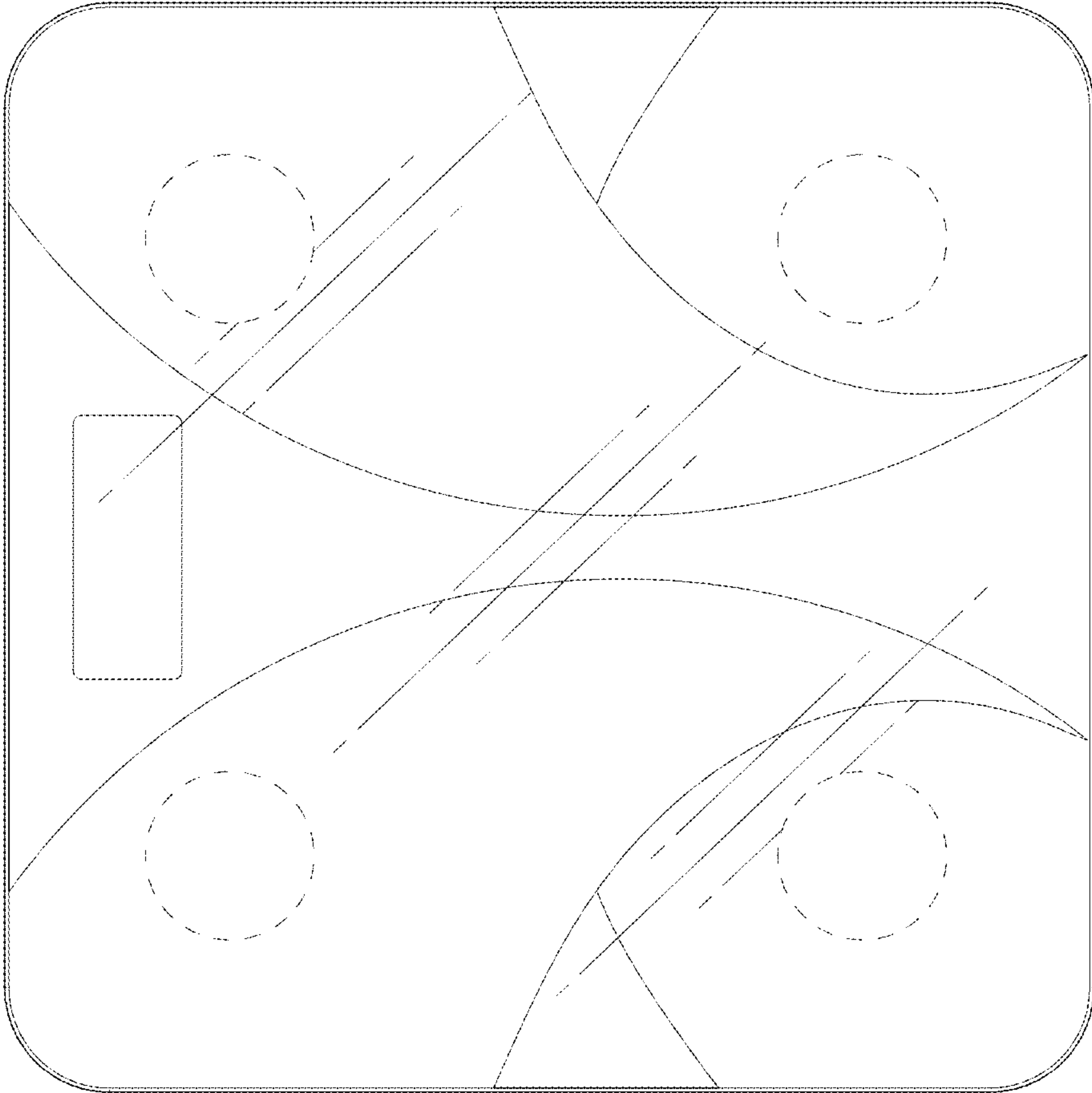

FIG. 6

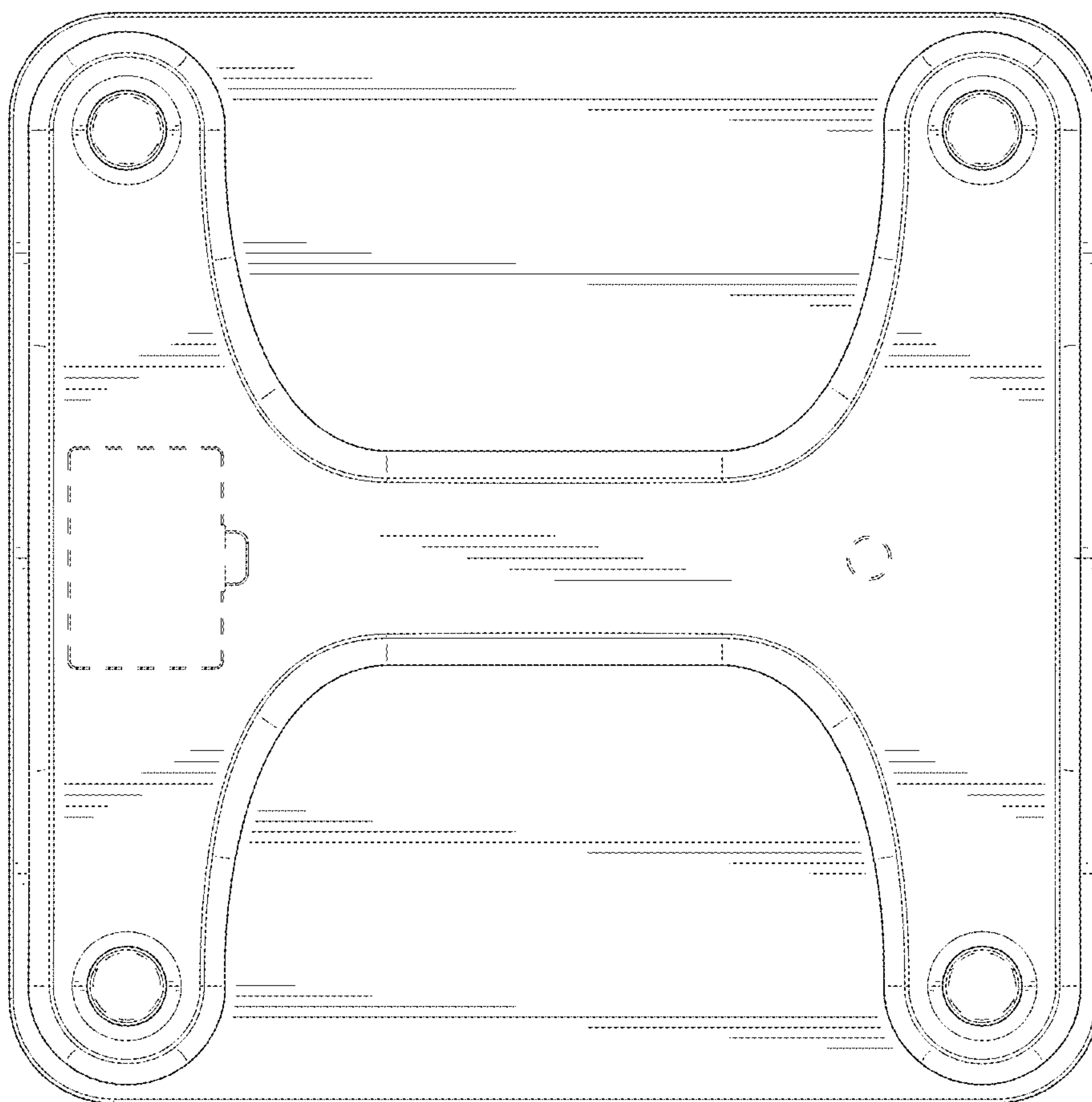

FIG. 7