

US00D944620S

(12) **United States Design Patent** (10) **Patent No.:** **US D944,620 S**
Singtoroj et al. (45) **Date of Patent:** **** Mar. 1, 2022**

(54) **DOOR HANDLE**

(71) Applicant: **Spectrum Brands, Inc.**, Middleton, WI (US)

(72) Inventors: **Yos Singtoroj**, Anaheim, CA (US);
Andy Chen, Xiamen (CN)

(73) Assignee: **Spectrum Brands, Inc.**, Middleton, WI (US)

(**) Term: **15 Years**

(21) Appl. No.: **29/753,382**

(22) Filed: **Sep. 30, 2020**

(51) **LOC (13) Cl.** **08-06**

(52) **U.S. Cl.**
USPC **D8/308**

(58) **Field of Classification Search**
USPC D8/300-302, 307-309, 310, 311,
D8/DIG. 10; D23/250, 252

CPC Y10T 16/44; Y10T 74/20612; Y10T 74/20732; Y10T 16/458; Y10T 16/498; Y10T 16/469; Y10T 16/476; Y10T 74/20744; Y10T 74/20864; Y10T 16/4628; Y10T 74/20642; Y10T 16/473; Y10T 74/20762; Y10T 74/2042; Y10T 74/20828; Y10T 16/459; Y10T 16/4713; Y10T 74/2014; Y10T 16/50; Y10T 74/20438; Y10T 74/20582; Y10T 74/20738; Y10T 16/48; Y10T 74/20618; Y10T 74/20684; Y10T 74/20624; Y10T 74/20468; Y10T 16/61; Y10T 16/4719; Y10T 16/86; Y10S 16/30; Y10S 292/31; Y10S 292/53; Y10S 16/12; Y10S 292/23; Y10S 292/27; Y10S 292/30; Y10S 292/63; E05B 85/16; E05B 1/0015; E05B 77/06; E05B 79/06; E05B 85/18; E05B 85/12; E05B 85/10; E05B 7/00; E05B 1/0053; E05B 77/265

See application file for complete search history.

(56) **References Cited**

U.S. PATENT DOCUMENTS

4,453,753 A * 6/1984 Fayerman E05B 65/104
292/169
D311,320 S * 10/1990 Jans D8/308
(Continued)

FOREIGN PATENT DOCUMENTS

CA 63085 A 5/1899
CA 118312 S 11/2007
(Continued)

OTHER PUBLICATIONS

“Yale Assure YRL256 Z-Wave Plus Touchscreen Keypad Lever”; GoKeyless retrieved Apr. 4, 2020; publication date unknown but prior to filing date of present application; URL: <<https://www.gokeyless.com/product/yale-assure-yrl256/>>.

(Continued)

Primary Examiner — Lauren R Calve

(74) *Attorney, Agent, or Firm* — Banner & Witcoff, Ltd.

(57) **CLAIM**

The ornamental design for a door handle, as shown and described.

DESCRIPTION

FIG. 1 is a front perspective view of a door handle showing our new design;
FIG. 2 is a front view thereof;
FIG. 3 is a rear view thereof;
FIG. 4 is a right side view thereof;
FIG. 5 is a left side view thereof;
FIG. 6 is a top view thereof;
FIG. 7 is a bottom view thereof; and,
FIG. 8 is a rear perspective view thereof.
The broken lines depicting portions the door handle form no part of the claimed design.

1 Claim, 5 Drawing Sheets

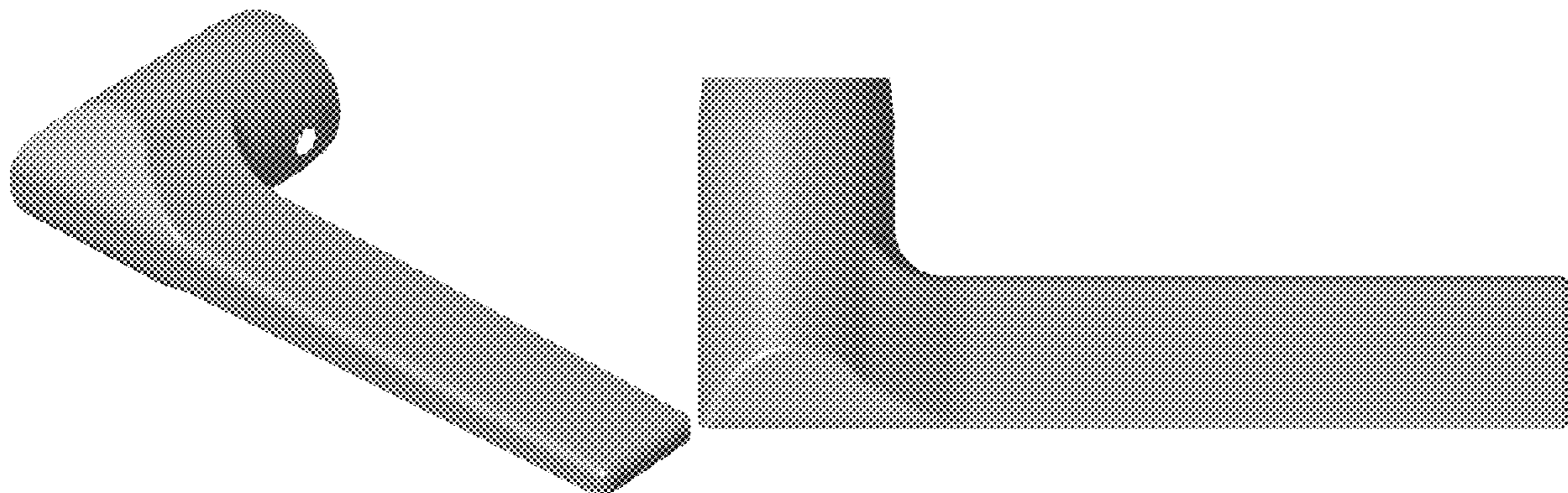

(56)

References Cited

U.S. PATENT DOCUMENTS

6,857,300	B1 *	2/2005	Heeley	E05B 13/004 70/472
D547,634	S	7/2007	Reithmeyer	
D579,305	S	10/2008	Schneider	
D621,681	S	8/2010	Roberts, III	
D621,682	S *	8/2010	Roberts, III	D8/308
D734,120	S *	7/2015	Hsu	D8/308
D734,122	S *	7/2015	Hsu	D8/308
D734,123	S	7/2015	Chen	
D745,360	S	12/2015	Sun	
D806,514	S	1/2018	Singtoroj	
D868,562	S *	12/2019	Yabu	D8/308
D915,560	S *	4/2021	Eads	D23/252
D921,472	S *	6/2021	Cowlin	D8/308
2017/0260773	A1 *	9/2017	Kim	E05B 1/0061

FOREIGN PATENT DOCUMENTS

CA	118261	S	1/2008
CA	159053	S	5/2015
CN	301894116		4/2012
CN	302380103		4/2013
CN	302401058		4/2013
CN	302524712		8/2013
CN	302548867		8/2013
CN	302586638		9/2013
CN	303539126		1/2016
CN	304109694		4/2017
CN	304741086		7/2018
CN	305113289		4/2019
CN	305431611		11/2019
CN	305558233		1/2020
CN	305601621		2/2020
CN	305616229		2/2020
CN	305616239		2/2020
WO	D204045-002		6/2019

OTHER PUBLICATIONS

“M8773 L3—Yale M8700 Series Classic style Entrance Door Handle Set L3”; Yale retrieved Apr. 4, 2020; publication date

unknown but prior to filing date of present application; URL: <<https://www.yale.com.hk/en/products/yale-door-lock-sets/door-handle-sets/mortise-door-ha>>.

“YSL-801, Solid Lever Handles, Stainless Steel Series, Lever Handles, Door Lever Handles, Yale Home Security, Mechanical Products, Yale”; Yale retrieved Apr. 4, 2020; publication date unknown but prior to filing date or present application; URL: <<https://www.decodeal.in/hardware/door-window-hardware/mortise-lock-lever-lock/ysl-801>>.

“Review: Yale Assure Level brings HomeKit to all door locks”; Apple Insider retrieved Apr. 4, 2020; publication date unknown but prior art to filing date of present application; URL: <<https://appleinsider.com/articles/19/08/05/review-yale-assure-lever-brings-homekit-to-all-do>>.

“Schlage Latitude Modern Lever”; Direct Door Hardware retrieved Apr. 5, 2020; publication date unknown but prior to filing date of present application; URL: <https://www.directdoorhardware.com/Schlage_Latitude_Door_Lever.htm>.

“Yale YH Collection Academy Leverset”; Park Avenue Locks retrieved Apr. 4, 2020; publication date unknown but prior to filing date of present application; URL: <<https://www.parkavenuelocks.com/yale-yh-collection-academy-leverset.html>>.

“Slip Stream Lever”, Taymor; retrieved Nov. 16, 2020; disclosure date unknown but prior to the filing date of present application; URL: <<https://www.taymor.com/en/products/doorware/slip-stream-lever>>.

“Taymor Equinox Lever”, Taymor; retrieved Nov. 16, 2020; disclosure date unknown but prior to the filing date of present application; URL: <<https://www.taymor.com/en/products/doorware/equinox-0>>.

“Defiant LEX703B Freedom Aged Bronze Hall and Closet Door Lever”; DK Hardware Supply; retrieved Nov. 16, 2020; disclosure date unknown but prior to the filing date of present application; URL: <<https://www.dkhardware.com/lex703b-freedom-aged-bronze-hall-and-closet-door-lever-product-3352554.html>>.

* cited by examiner

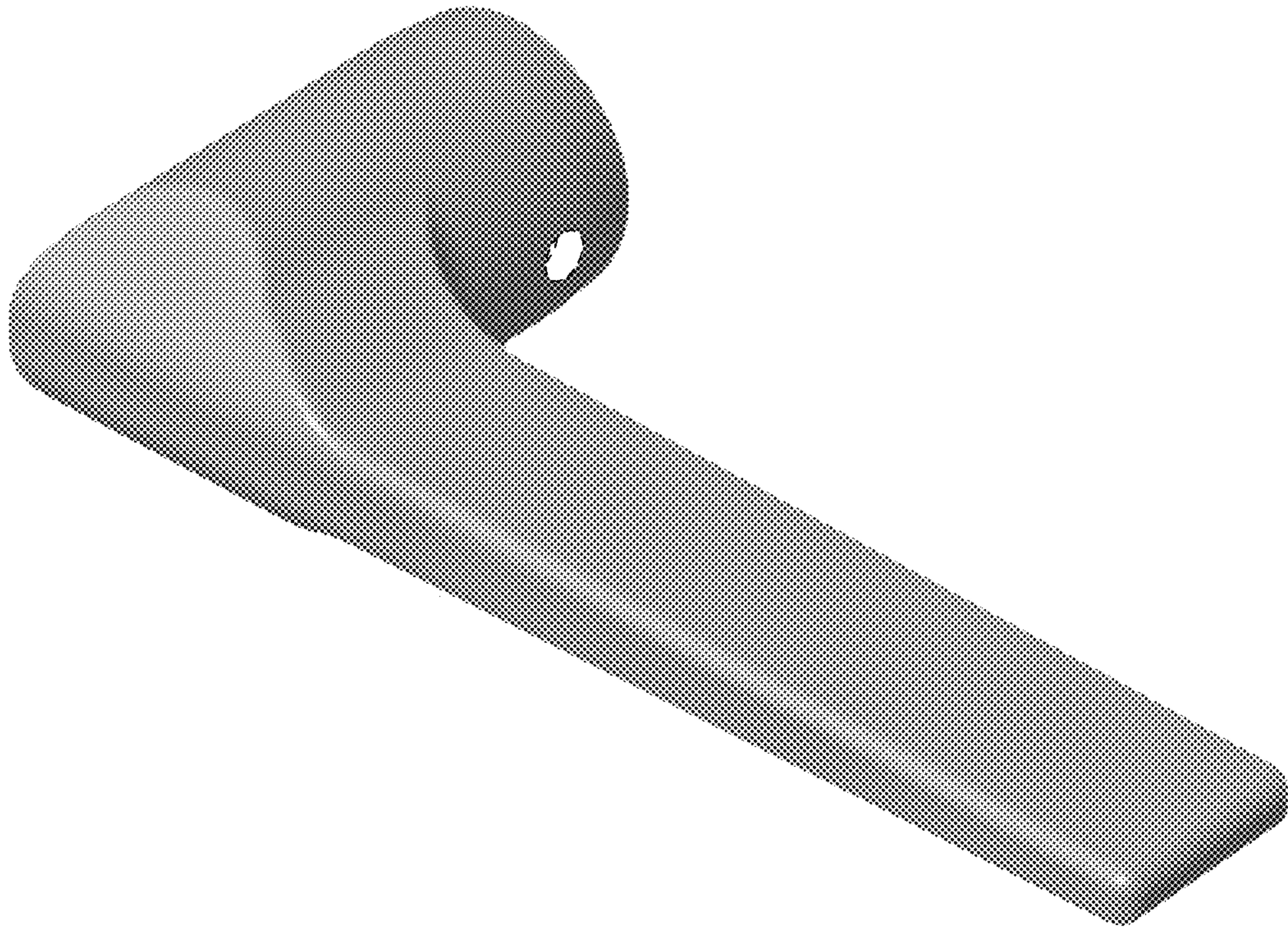

FIG. 1

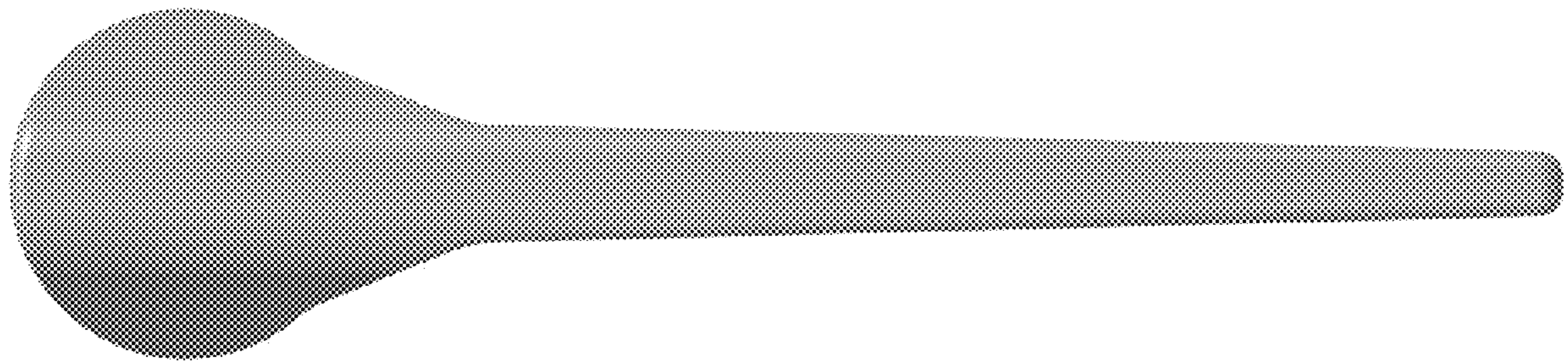

FIG. 2

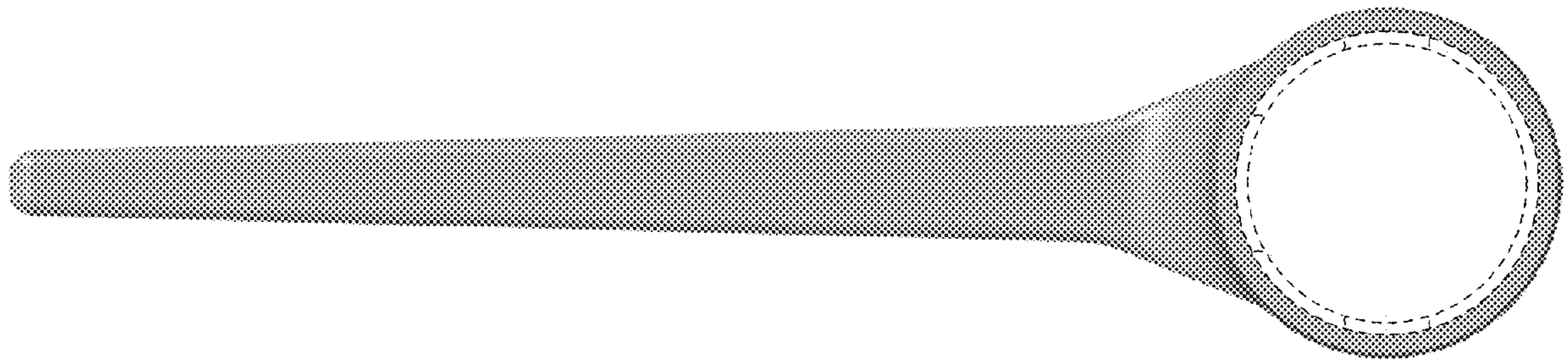

FIG. 3

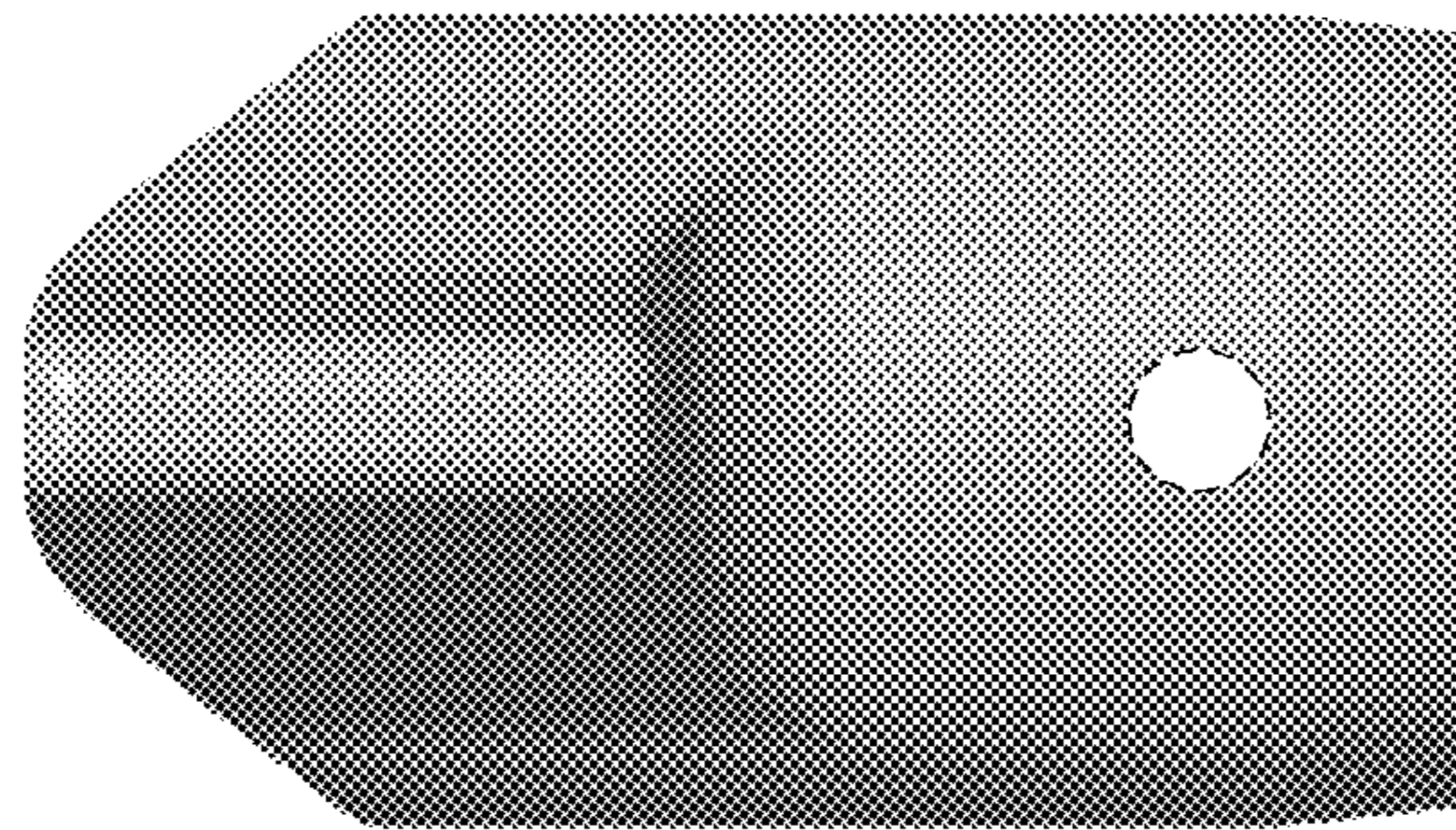

FIG. 4

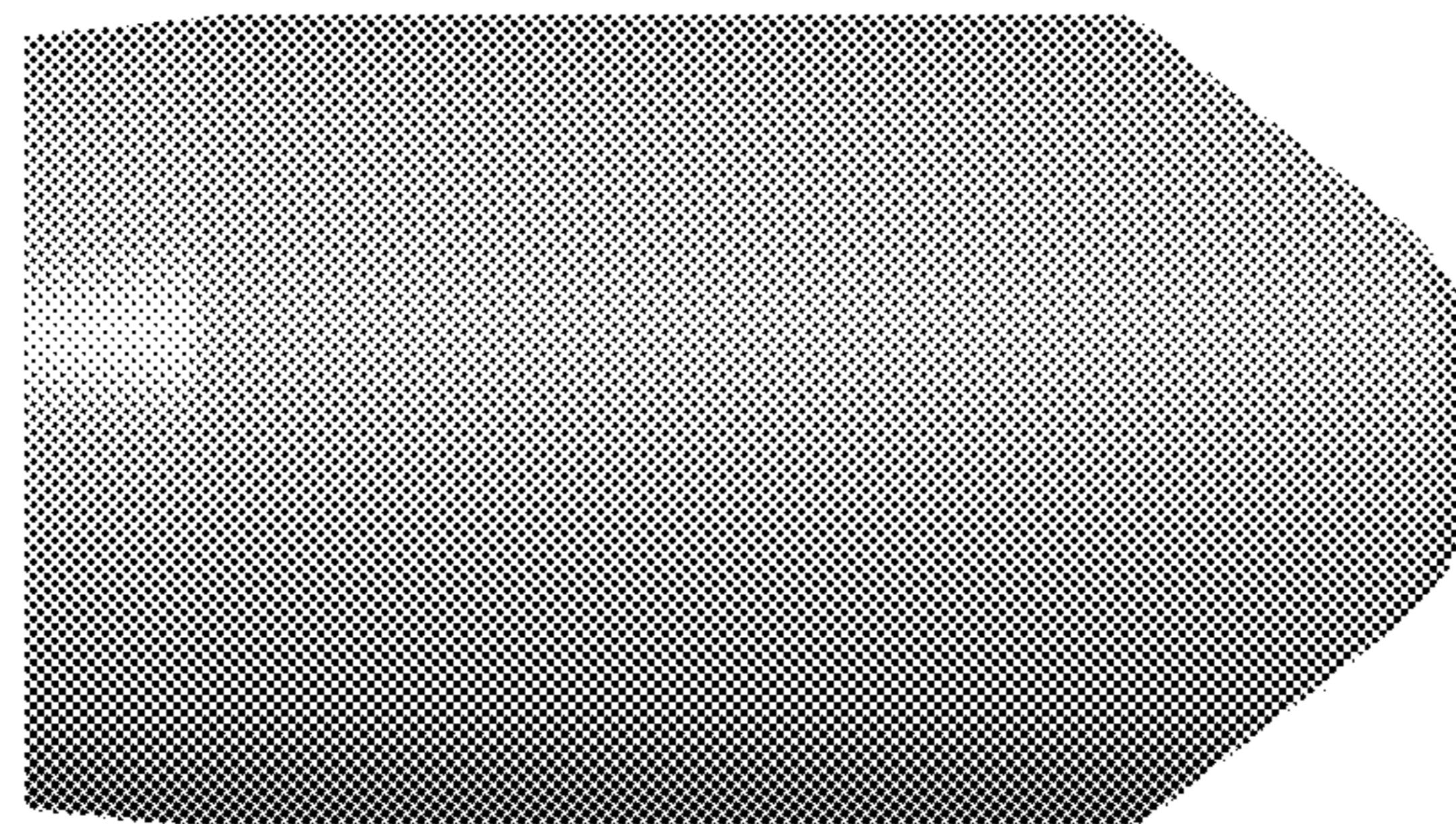

FIG. 5



FIG. 6

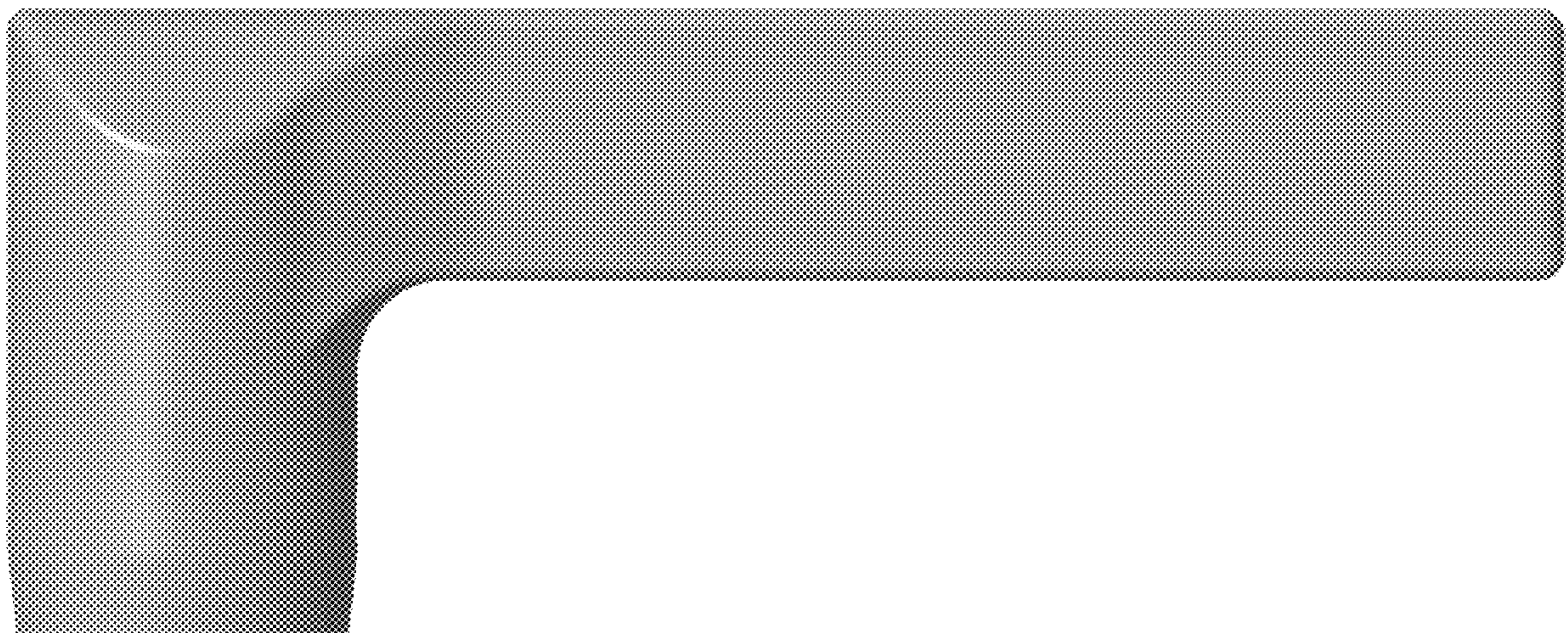

FIG. 7

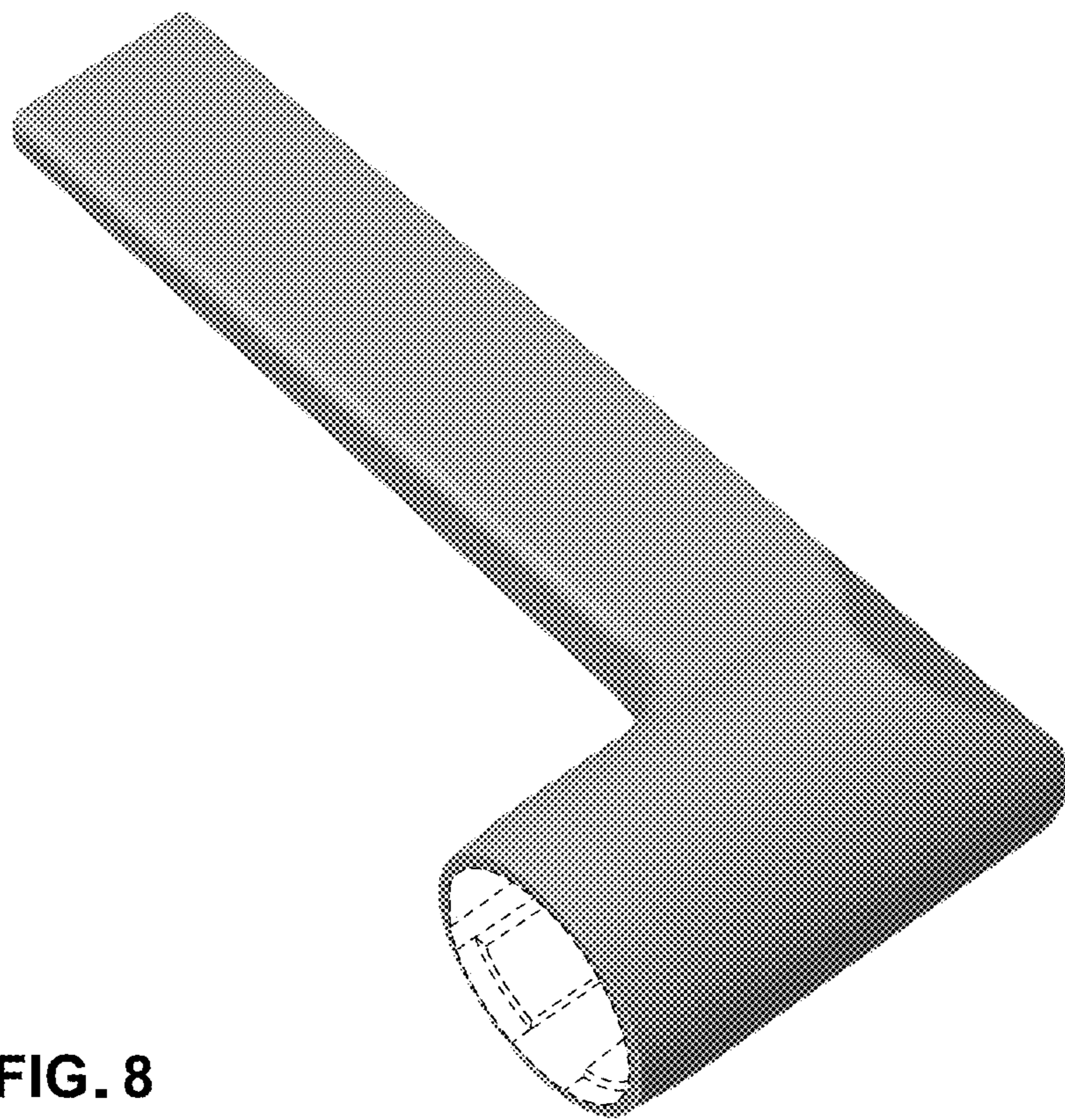

FIG. 8