



US00D944593S

(12) **United States Design Patent** (10) **Patent No.:** **US D944,593 S**  
**Hundley et al.** (45) **Date of Patent:** **\*\* Mar. 1, 2022**

(54) **COUNTERTOP APPLIANCE**

- (71) Applicant: **The Vollrath Company, L.L.C.**,  
Sheboygan, WI (US)
- (72) Inventors: **Jill Hundley**, Sheboygan, WI (US);  
**Rebecca Neils**, Sheboygan, WI (US)
- (73) Assignee: **The Vollrath Company, L.L.C.**,  
Sheboygan, WI (US)
- (\*\*) Term: **15 Years**
- (21) Appl. No.: **29/787,881**
- (22) Filed: **Jun. 9, 2021**

**Related U.S. Application Data**

- (63) Continuation of application No. 29/678,979, filed on  
Jan. 31, 2019, now Pat. No. Des. 924,630.
- (51) **LOC (13) Cl.** ..... **07-99**
- (52) **U.S. Cl.**  
USPC ..... **D7/402**
- (58) **Field of Classification Search**  
USPC ..... D7/402, 403, 407, 408, 409, 323, 332,  
D7/334, 337, 346, 362, 363, 367;  
D10/83, 87, 94, 103  
CPC ..... G01G 19/40; G01G 21/28; A21B 2/00;  
A47J 37/00; A47J 37/06; F24C 7/00;  
F24C 15/12  
See application file for complete search history.

(56) **References Cited**

**U.S. PATENT DOCUMENTS**

- D339,538 S \* 9/1993 Fellmann ..... D10/91
- D613,117 S 4/2010 Richburg
- D699,136 S \* 2/2014 Ammon ..... D10/91
- D705,683 S 5/2014 Lauer
- D727,766 S \* 4/2015 Wu ..... D10/91

(Continued)

**OTHER PUBLICATIONS**

New 2019 Smallwares Countertop Equipment Catalogue, Induction Ranges, pp. 29-33, [https://vollrath.com/Vollrath-Files/Price-Lists/New\\_2019\\_Smallwares\\_Countertop\\_Equipment\\_Catalog\\_Web.pdf](https://vollrath.com/Vollrath-Files/Price-Lists/New_2019_Smallwares_Countertop_Equipment_Catalog_Web.pdf), accessed Jun. 3, 2019.

*Primary Examiner* — Michelle E. Wilson

*Assistant Examiner* — Andrew Kerr

(74) *Attorney, Agent, or Firm* — Foley & Lardner LLP

(57) **CLAIM**

We claim the ornamental design for a countertop appliance, as shown and described.

**DESCRIPTION**

FIG. 1 is a front perspective view of a first embodiment of a countertop appliance of our new design; FIG. 2 is a front elevation view thereof; FIG. 3 is a rear elevation view thereof; FIG. 4 is a right side elevation view thereof; FIG. 5 is a left side elevation view thereof; FIG. 6 is a top plan view thereof; FIG. 7 is a bottom plan view thereof; FIG. 8 is a front perspective view of a second embodiment of a countertop appliance of our new design; FIG. 9 is a front elevation view thereof; FIG. 10 is a rear elevation view thereof; FIG. 11 is a right side elevation view thereof; FIG. 12 is a left side elevation view thereof; FIG. 13 is a top plan view thereof; and, FIG. 14 is a bottom plan view thereof.

The even spaced dash-dash broken lines in the figures depict portions of the countertop appliance that form no part of the claimed design. The dash-dot broken lines in the figures define the bounds of the claimed design and form no part thereof.

The countertop appliance is shown with symbolic breaks in length and width. The appearance of any portion of the article between the break lines forms no part of the claimed design.

**1 Claim, 10 Drawing Sheets**

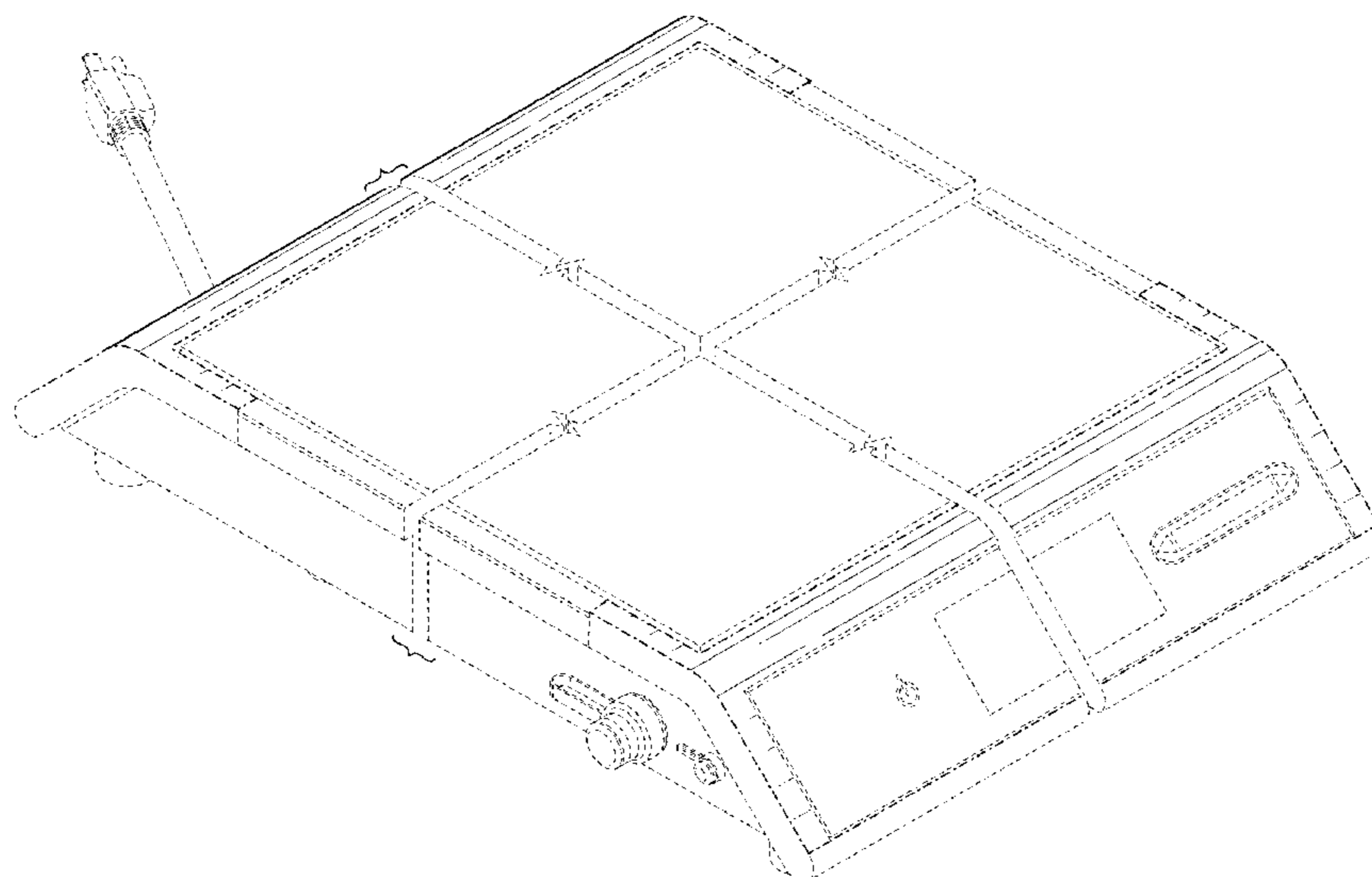

(56)

**References Cited**

U.S. PATENT DOCUMENTS

D775,540 S	1/2017	Marmier	
D818,770 S	5/2018	Boyd	
D831,404 S	10/2018	Glucksman et al.	
D841,502 S *	2/2019	Wu .....	D10/91
D843,866 S	3/2019	Mutch et al.	
D865,452 S	11/2019	Hertaus et al.	
D870,579 S	12/2019	Zong et al.	
D926,061 S *	7/2021	Jiang .....	D10/91
2008/0245580 A1	10/2008	Aby-Eva et al.	
2009/0194340 A1 *	8/2009	Mock .....	G01G 21/286 177/180
2012/0125697 A1 *	5/2012	Lauer .....	G01G 21/28 177/1

\* cited by examiner

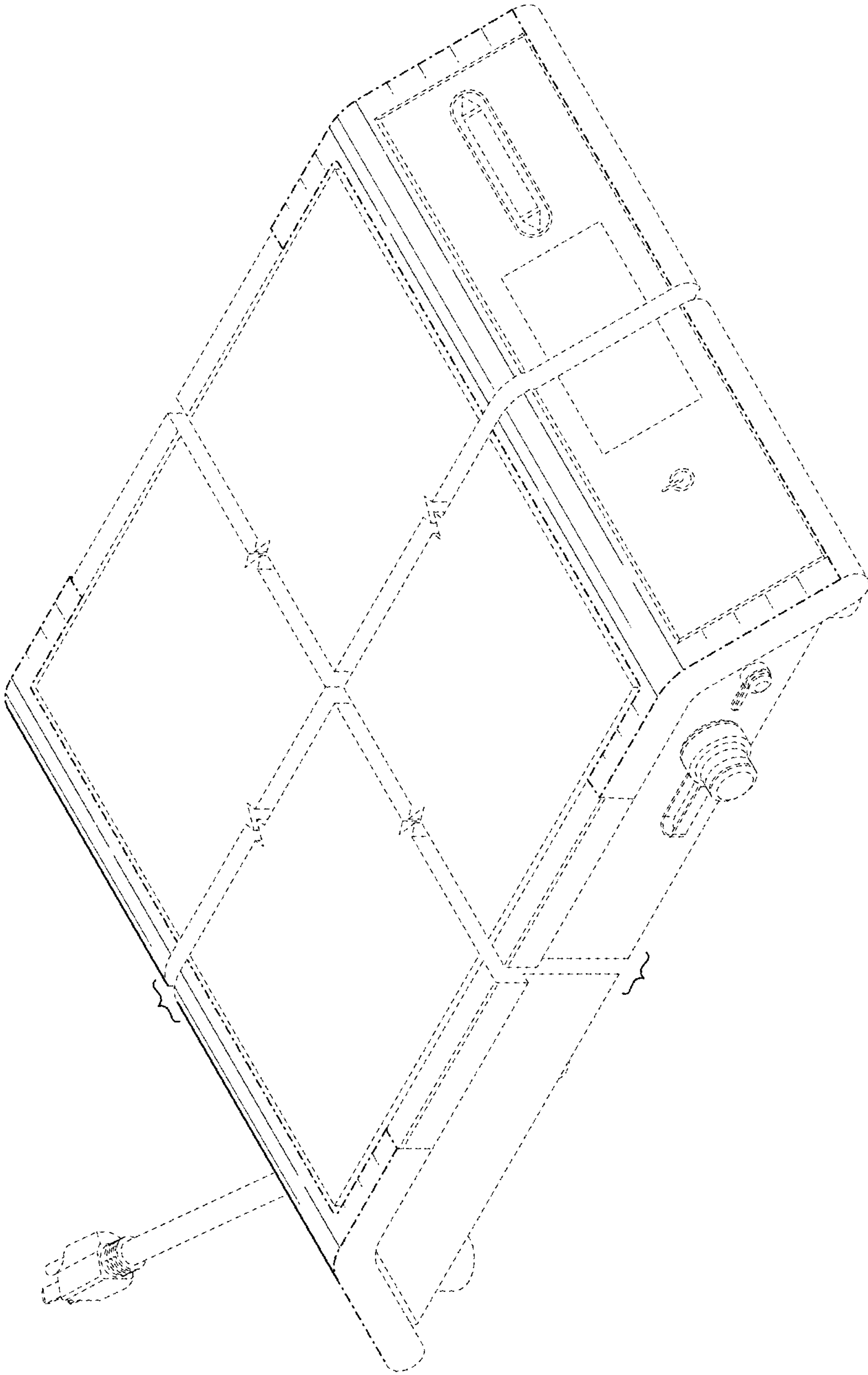

FIG. 1

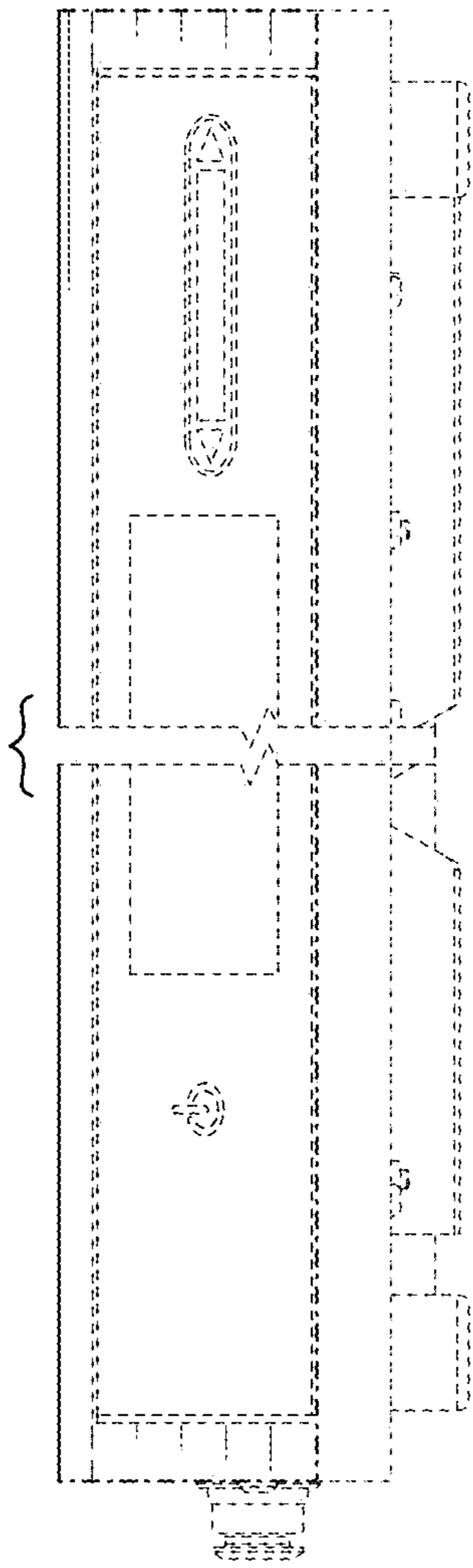

FIG. 2

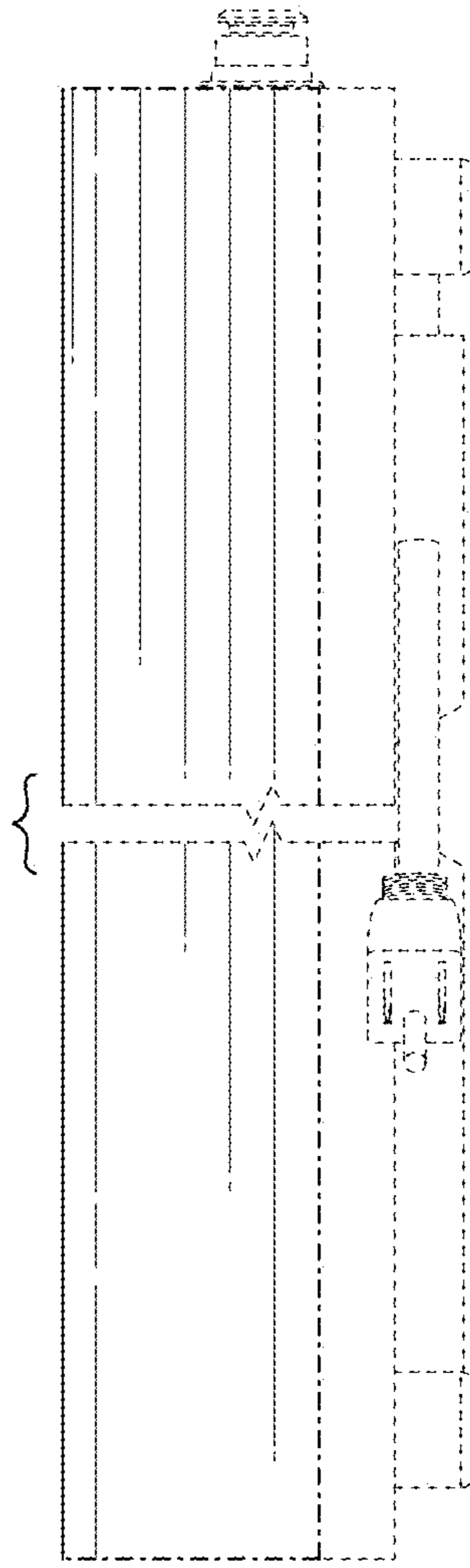

FIG. 3

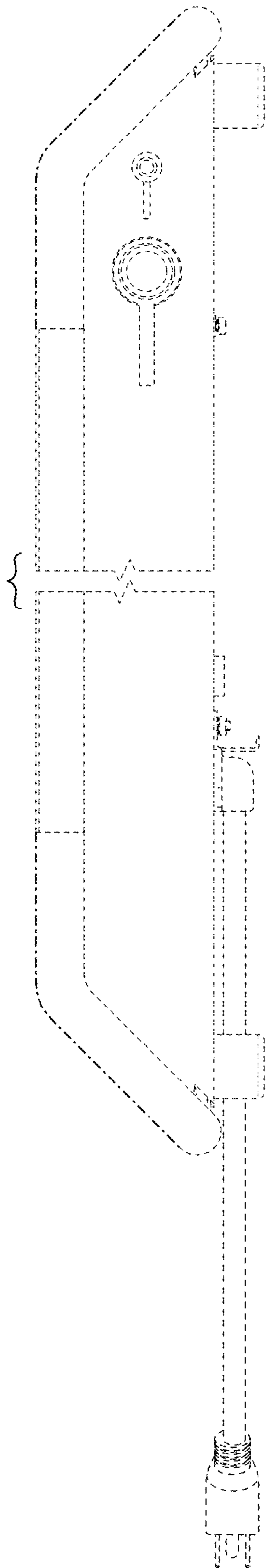

FIG. 4

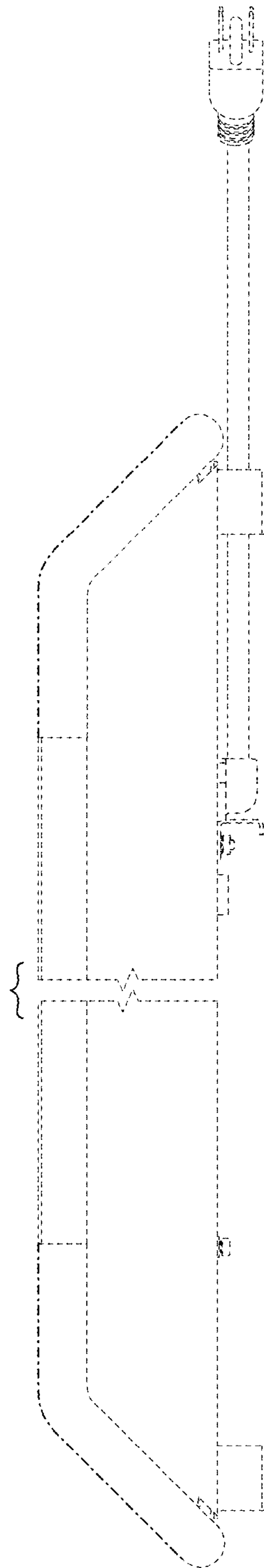

FIG. 5

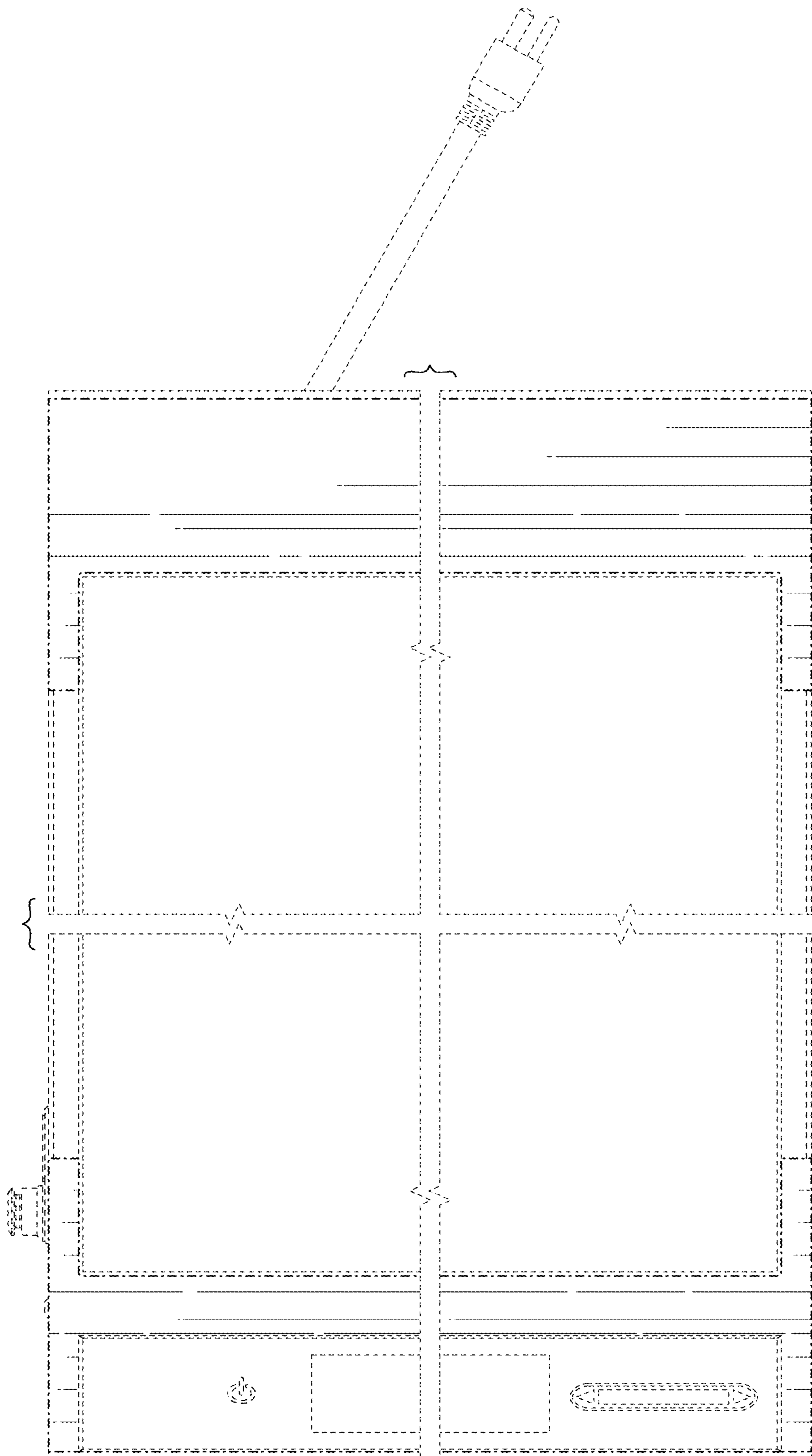
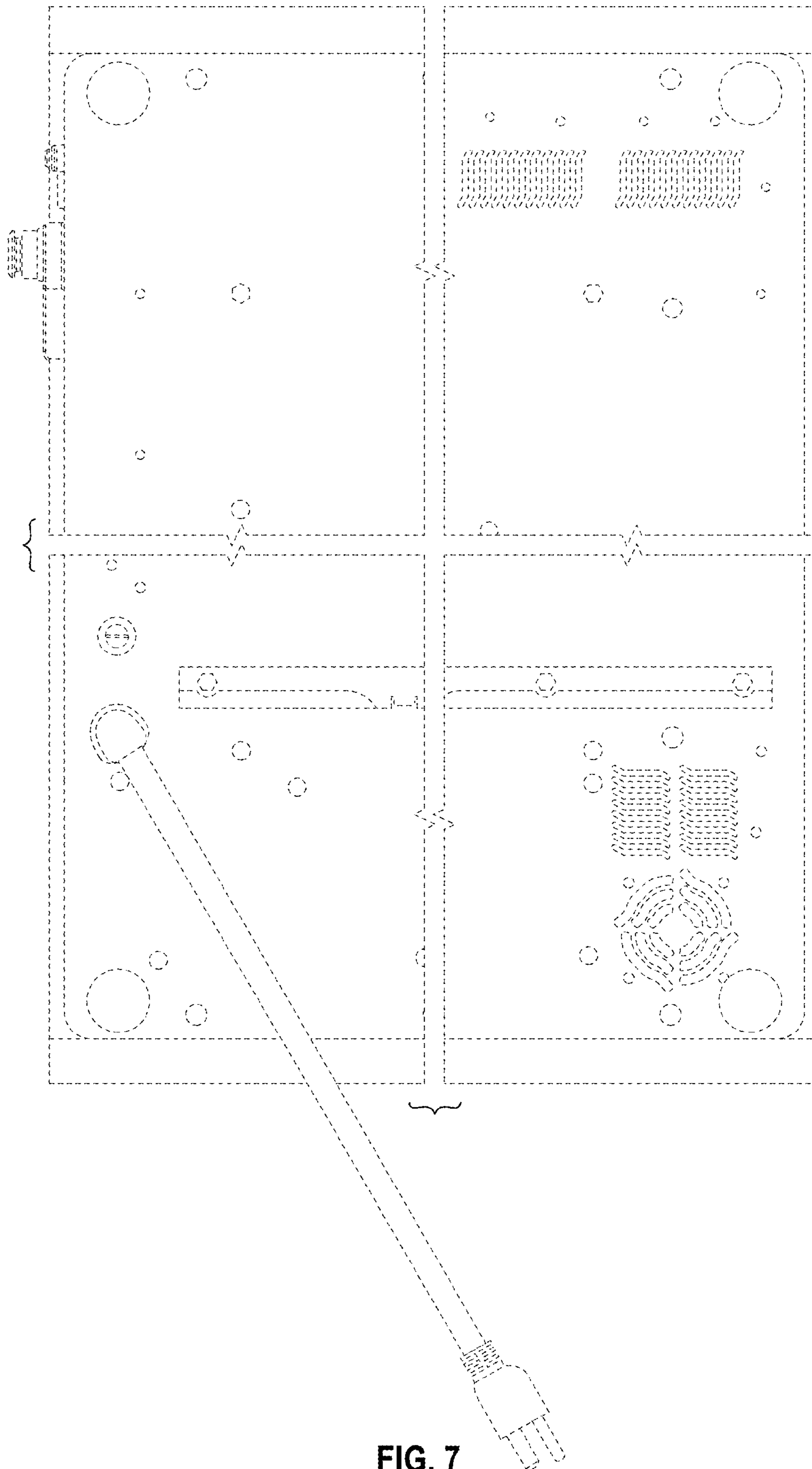

FIG. 6



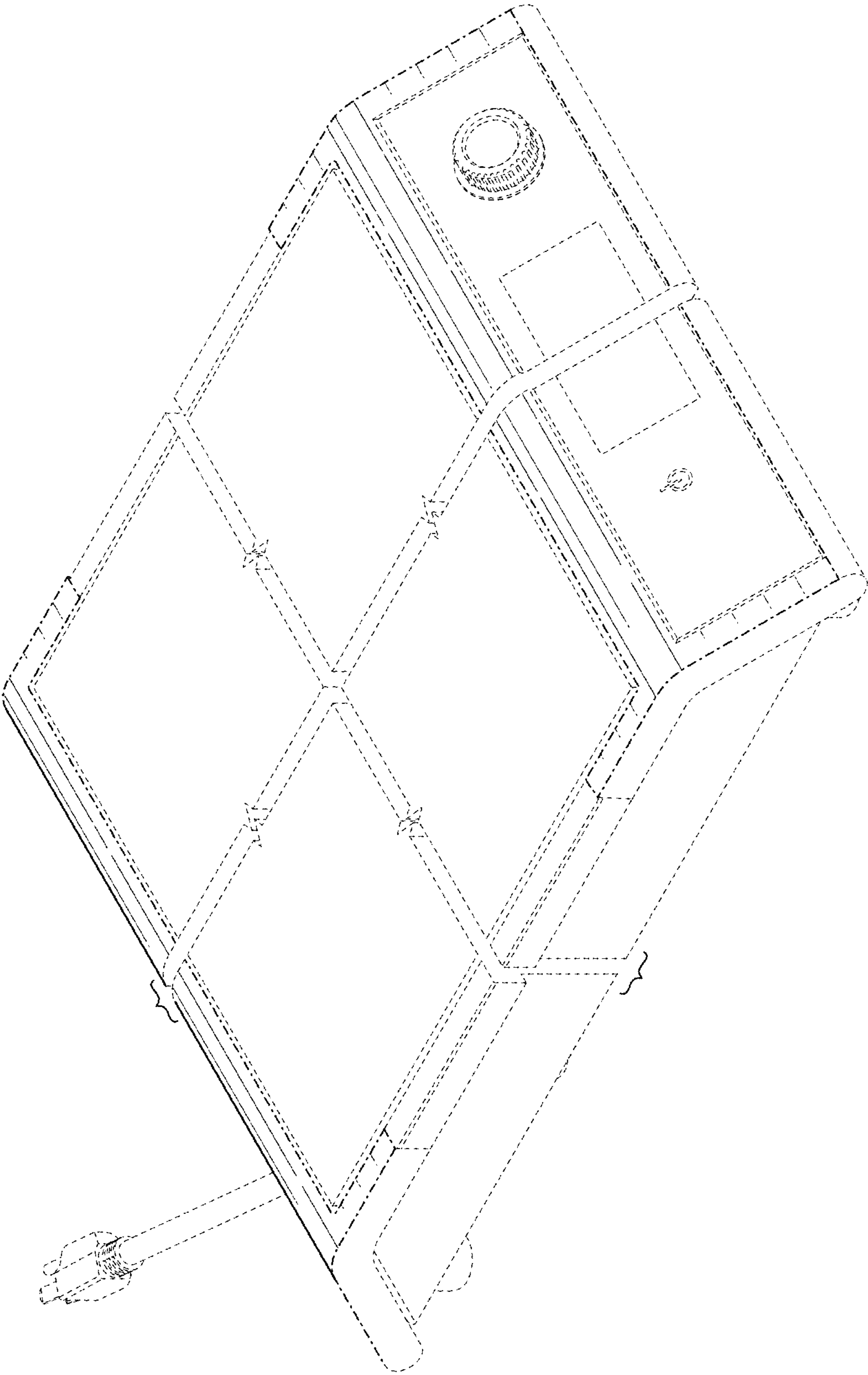

FIG. 8



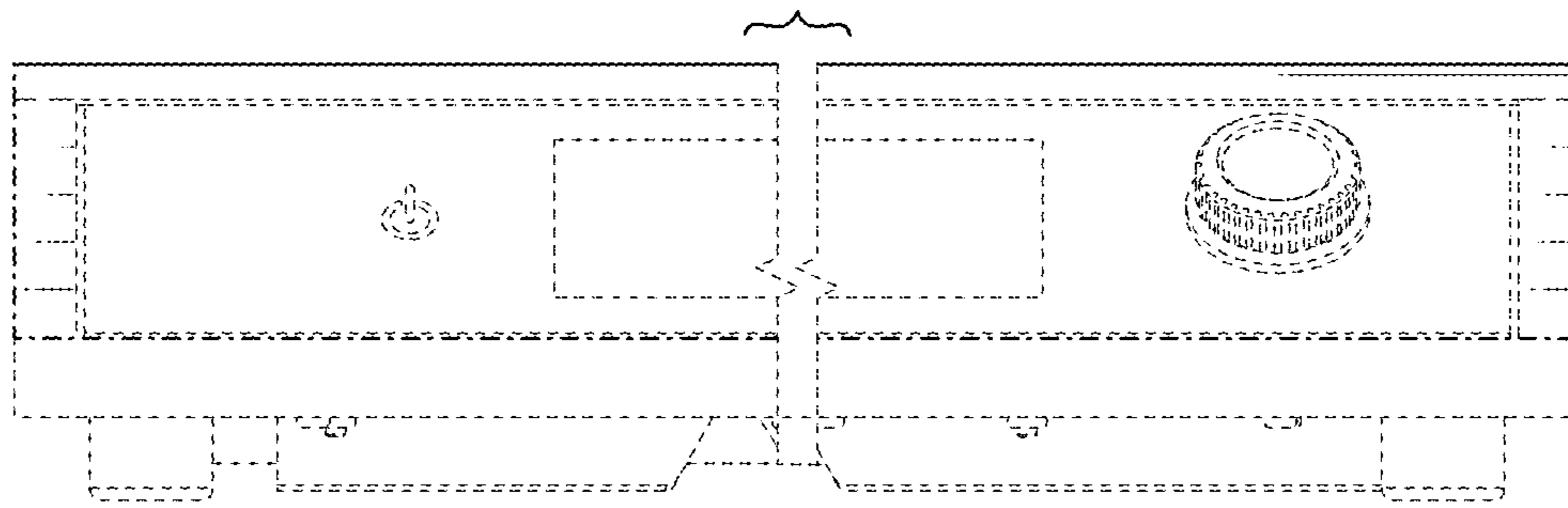

FIG. 9

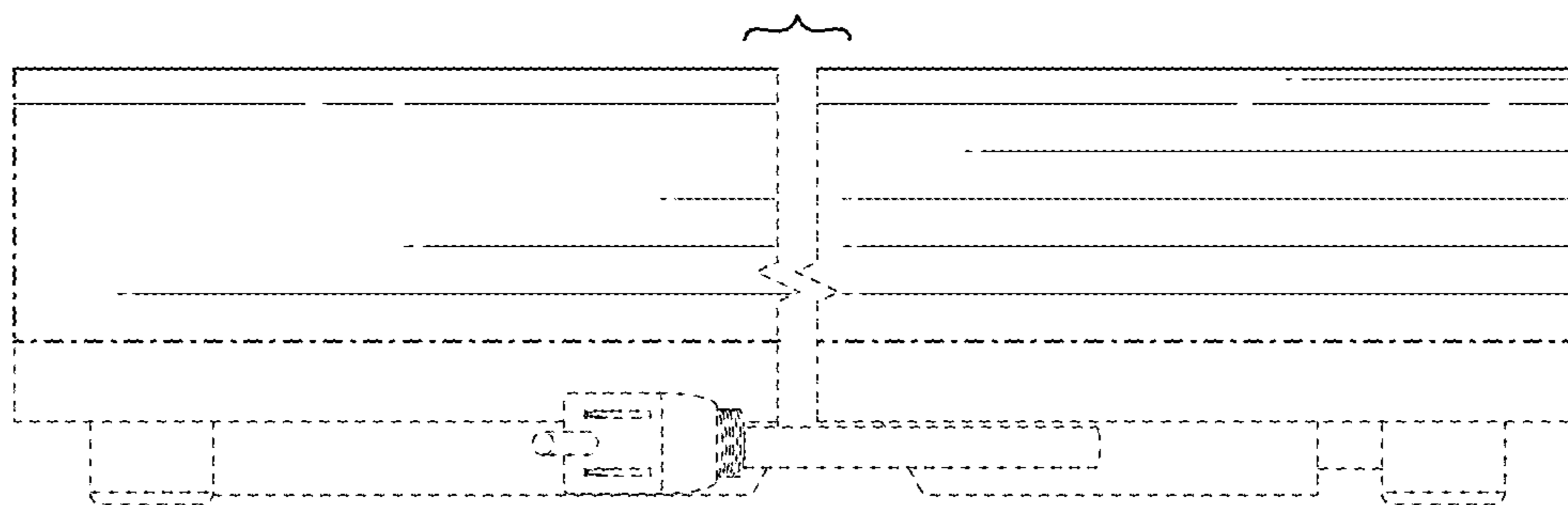

FIG. 10

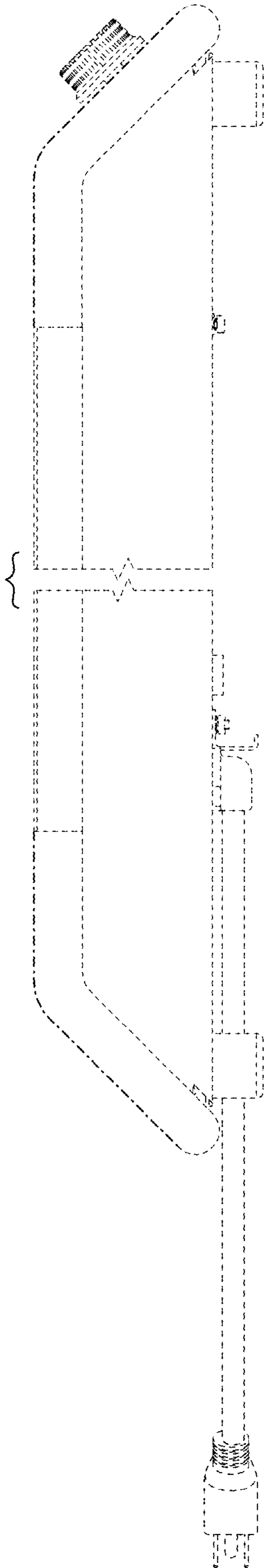

FIG. 11

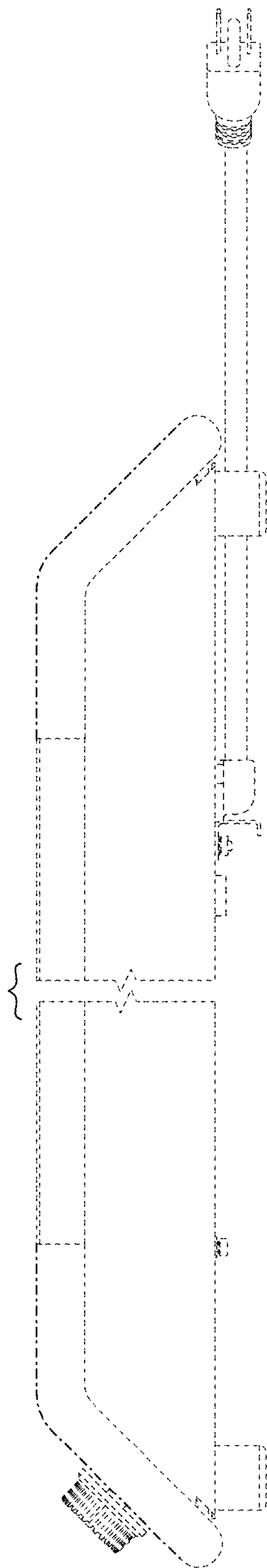

FIG. 12

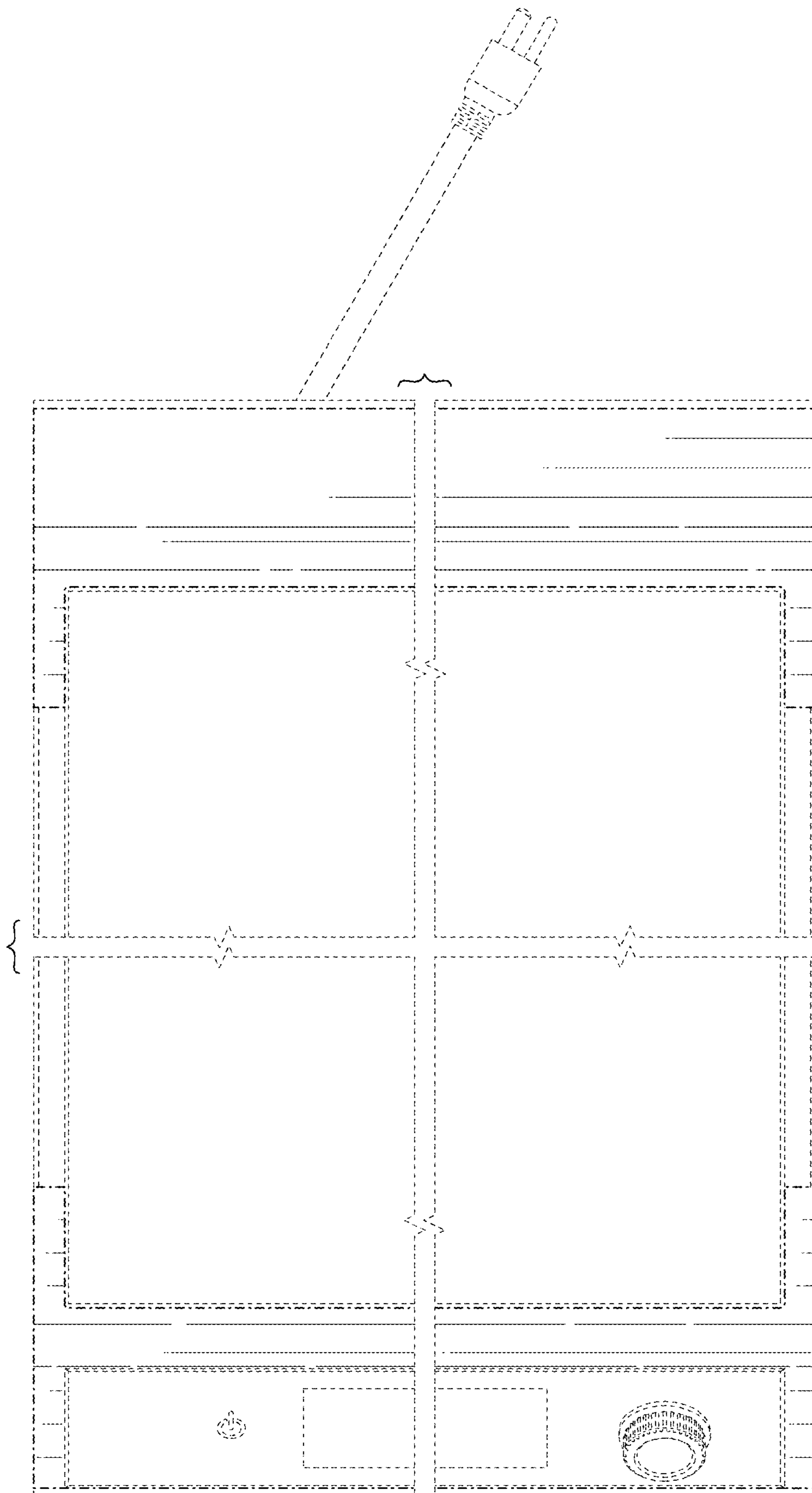

FIG. 13

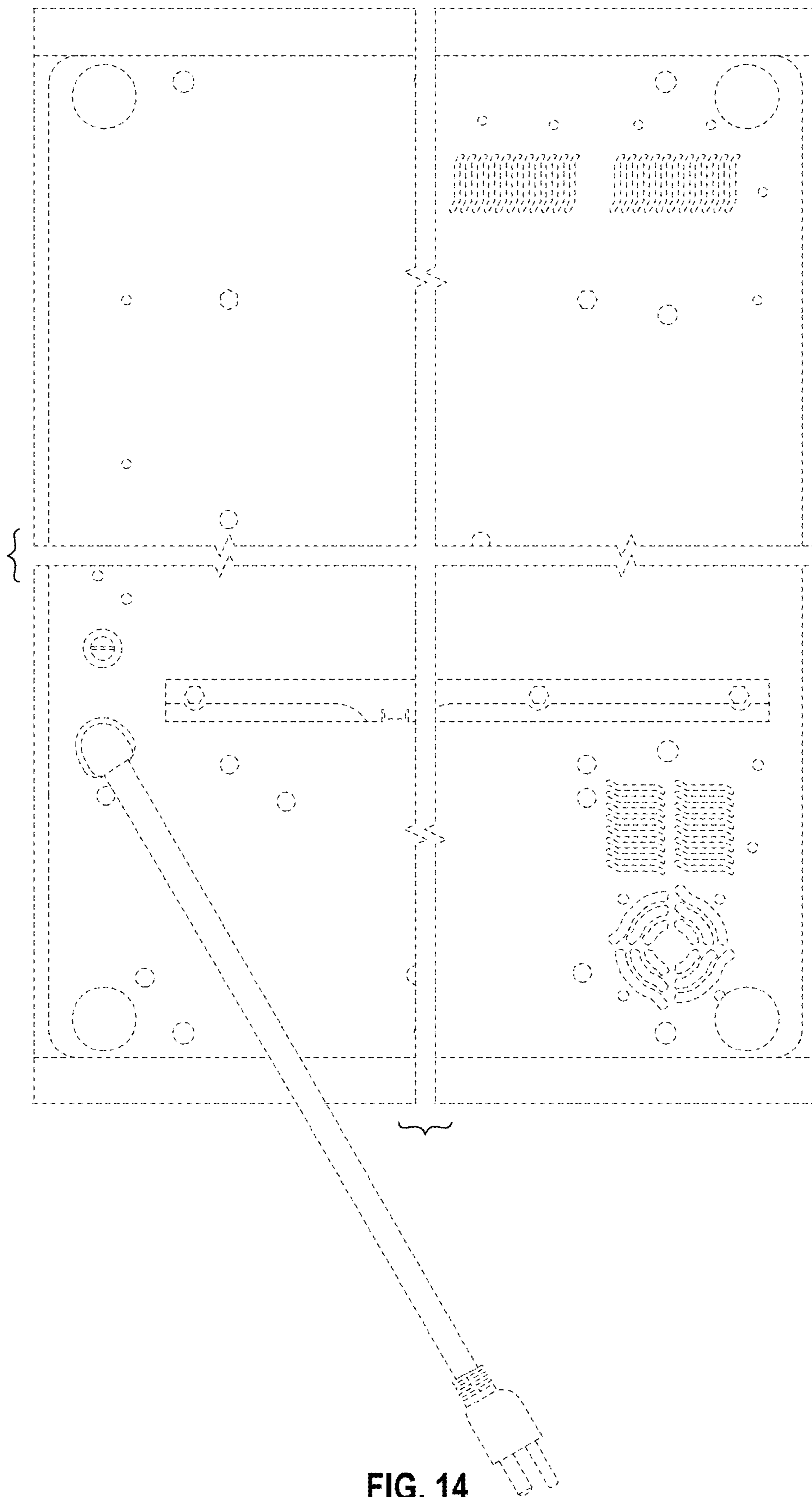

FIG. 14