



US00D944592S

(12) **United States Design Patent** (10) **Patent No.:** **US D944,592 S**
von Schoultz (45) **Date of Patent:** **** Mar. 1, 2022**

(54) **TEA INFUSER**

OTHER PUBLICATIONS

(71) Applicant: **Erik von Schoultz**, Stockholm (SE)

DDG Drosselmeyer Infuser Stainless Steel Tea Strainer and Spoon, Amazon, [online], [site visited Dec. 9, 2021], Available from internet URL: <https://www.amazon.com/DDG-Drosselmeyer-Infuser-Stainless-Strainer/dp/B08L82HW5R> (Year: 2021).*

(72) Inventor: **Erik von Schoultz**, Stockholm (SE)

Tea Infuser Tea Strainer, Walmart, [online], [site visited Dec. 9, 2021], Available from internet URL: <https://www.walmart.com/ip/Tea-Infuser-Strainer-Healthy-Flavor-Total-Gadget-Measure-Swirl-Steep-Stir-And-Press-Food-Grade-PlasticTea-Coffee-Loose-Leaf/535419061> (Year: 2021).*

(**) Term: **15 Years**

The Tea Infuser Silver, Drosselmeyer, [online], [site visited Dec. 9, 2021], Available from internet URL: <https://drosselmeyer.com/collections/frontpage/products/the-tea-infuser> (Year: 2021).*

(21) Appl. No.: **29/736,496**

(22) Filed: **Jun. 1, 2020**

(51) **LOC (13) Cl.** **07-02**

(52) **U.S. Cl.**

USPC **D7/400**

(58) **Field of Classification Search**

USPC D7/300, 301–303, 305, 306, 309,
D7/312–314, 316–319, 387, 397–400,
D7/678; D23/207, 209, 213
CPC . A47G 19/16; A47J 31/02; A47J 31/06; A47J
31/061; A47J 31/0615; A47J 31/0642;
A47J 31/0673; A47J 31/18; A47J 31/20;
A47J 31/3628; A47J 31/407; A47J 31/44;
A47J 31/4403; A47J 31/4482; A47J
31/46; A47J 31/50; A47J 31/505

See application file for complete search history.

* cited by examiner

Primary Examiner — Mary Ann Calabrese

Assistant Examiner — Natalya M Rapundalo

(74) *Attorney, Agent, or Firm* — Patentfile, LLC; Bradley C. Fach

(56) **References Cited**

U.S. PATENT DOCUMENTS

D447,016 S * 8/2001 Landstrom D7/668
D613,114 S * 4/2010 Hewitt D7/400
D720,588 S * 1/2015 Pugh D8/47
D742,184 S * 11/2015 Roberts D7/678
D784,922 S * 4/2017 Liden D13/107
D820,638 S * 6/2018 Chitayat D7/400
D854,883 S * 7/2019 Josefsson D7/400
D854,884 S * 7/2019 Josefsson A47J 43/255
D7/400
D914,166 S * 3/2021 Diefenbach D23/261
2004/0217219 A1 * 11/2004 Bitonto A47J 43/255
241/95

(57) **CLAIM**

The ornamental design for a tea infuser, as shown and described.

DESCRIPTION

FIG. 1 is a perspective view showing the new, original, and ornamental design of a tea infuser;

FIG. 2 is a left elevation view thereof, the right side being a mirror image;

FIG. 3 is a rear elevation view thereof;

FIG. 4. is a front elevation view thereof;

FIG. 5. is a top plan view thereof; and,

FIG. 6 is a bottom plan view thereof.

The dash-dash and half circle broken lines shown in FIG. 1 and FIG. 5 on the top area of the tea infuser represent portions of the tea infuser and form no part of the claimed design.

1 Claim, 4 Drawing Sheets

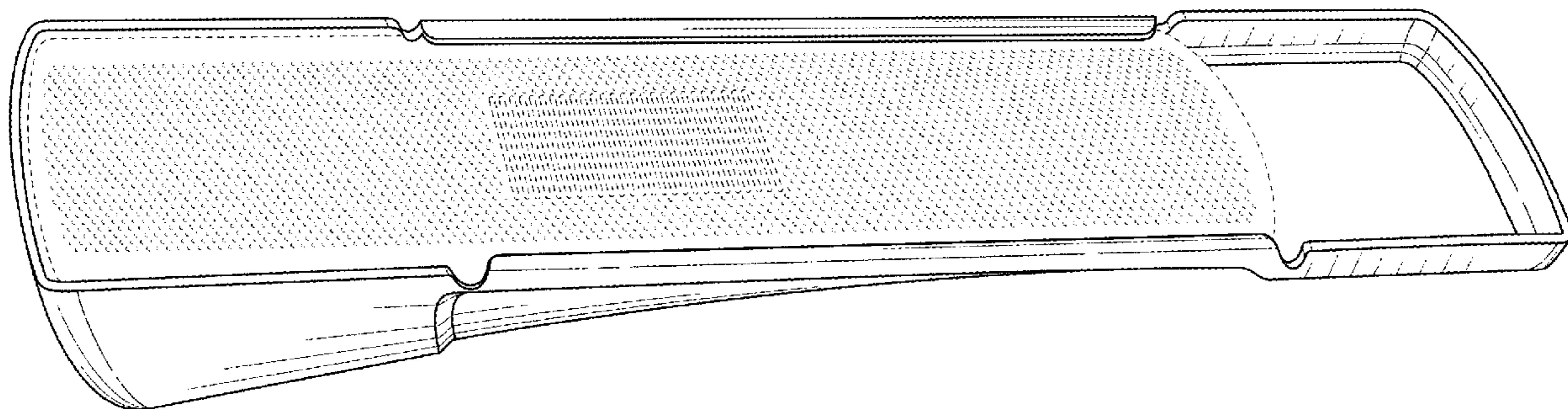

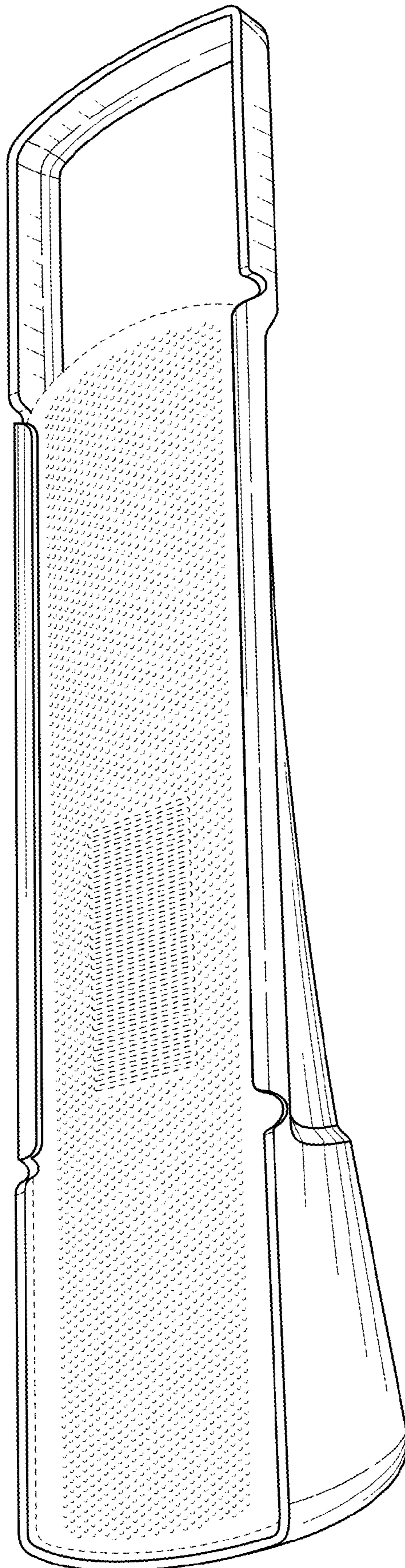

FIG. 1

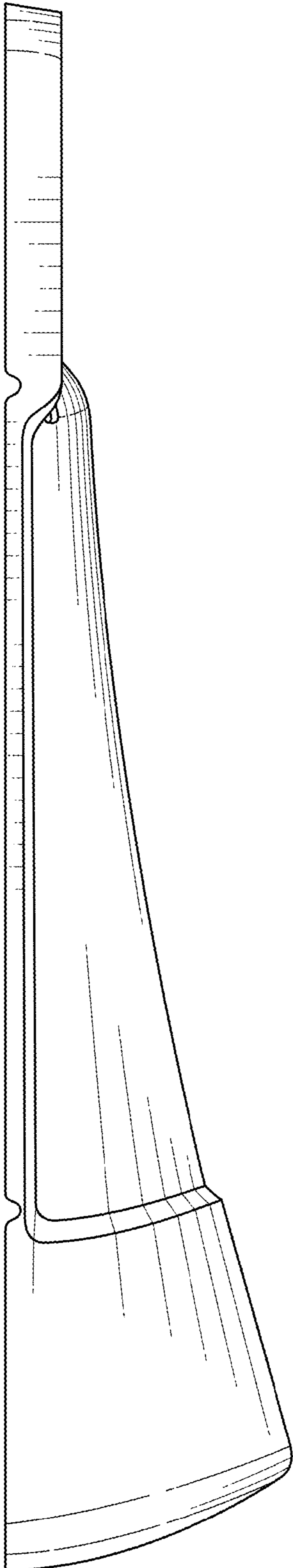

FIG. 2

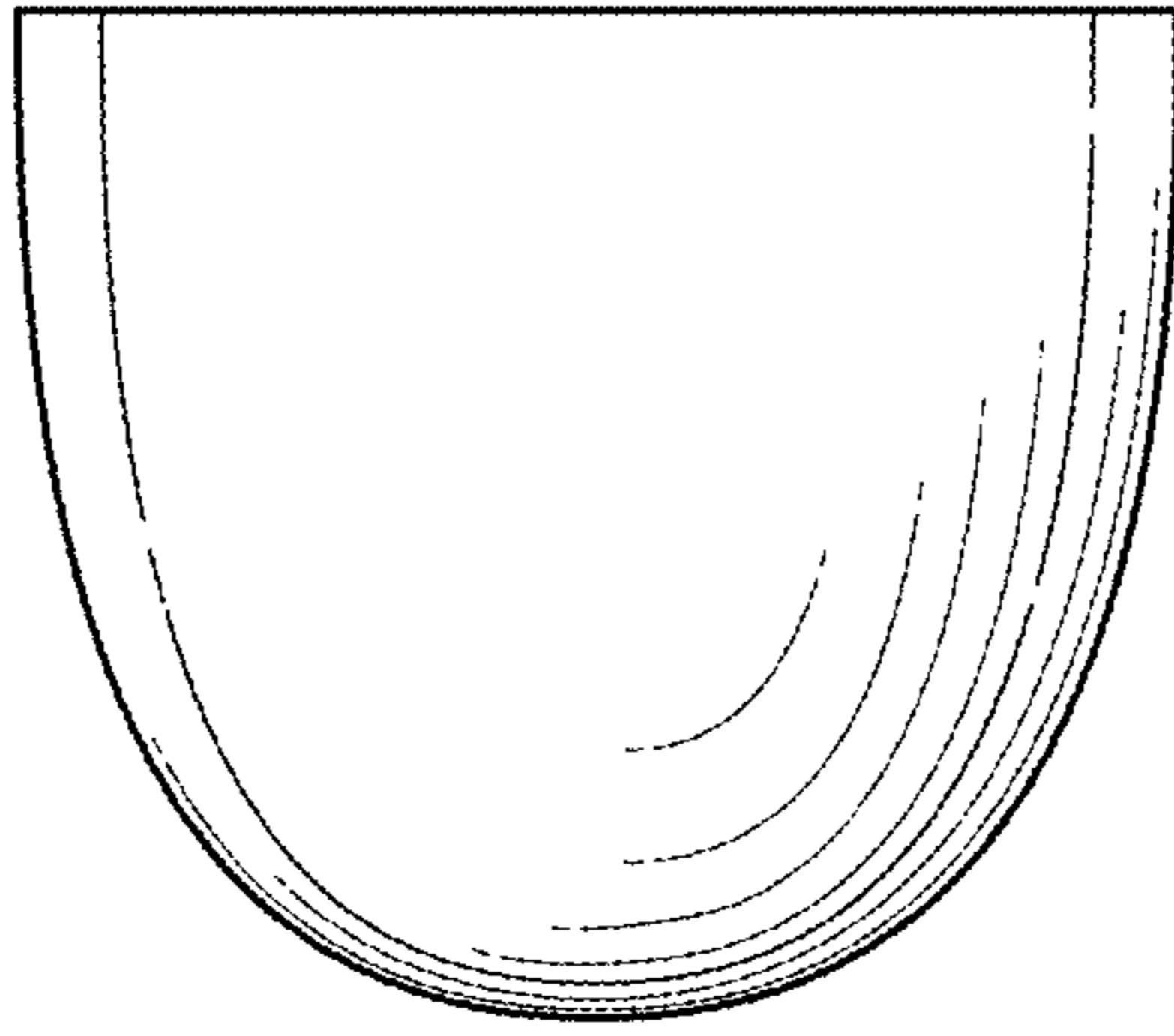

FIG. 3

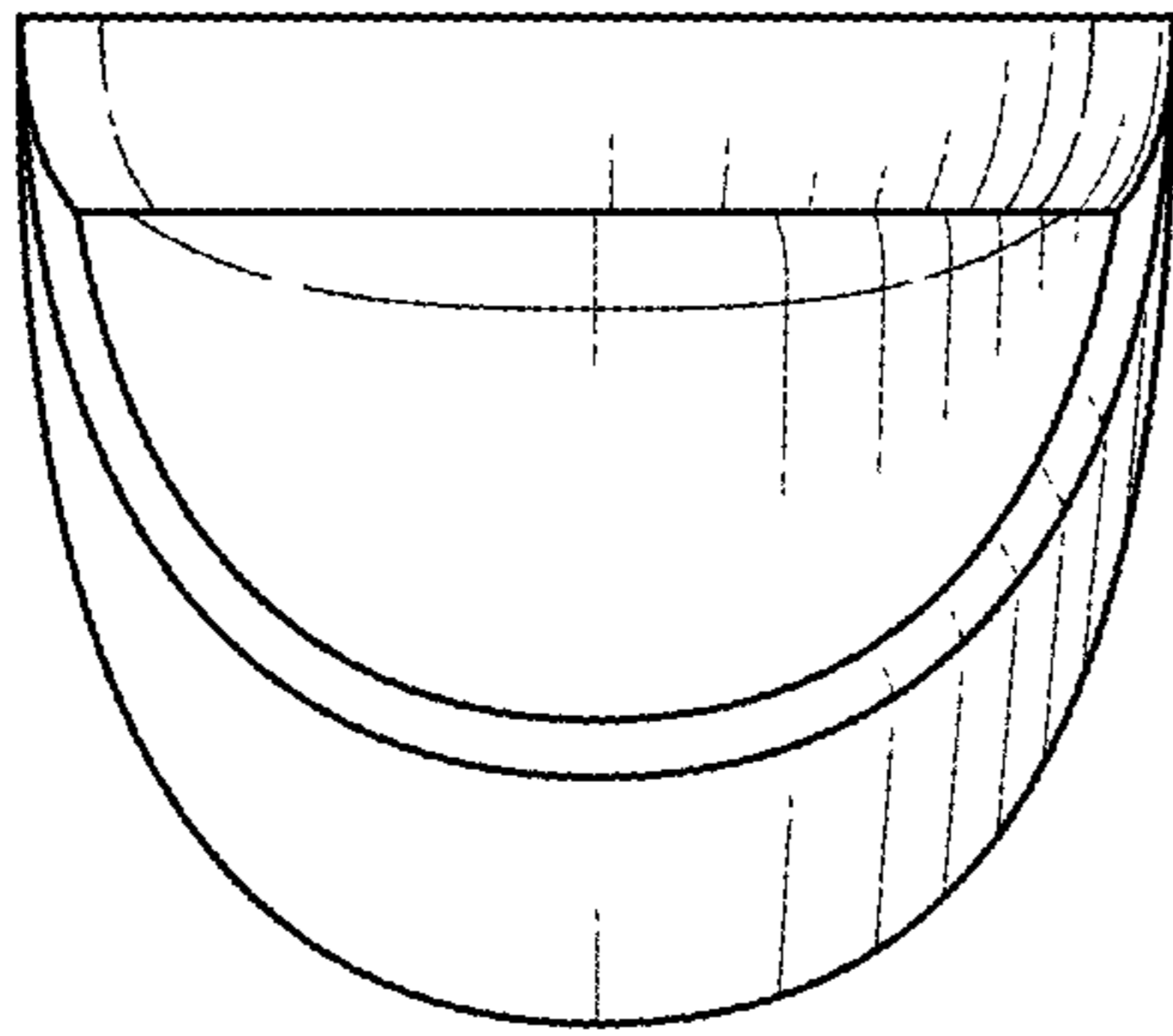

FIG. 4

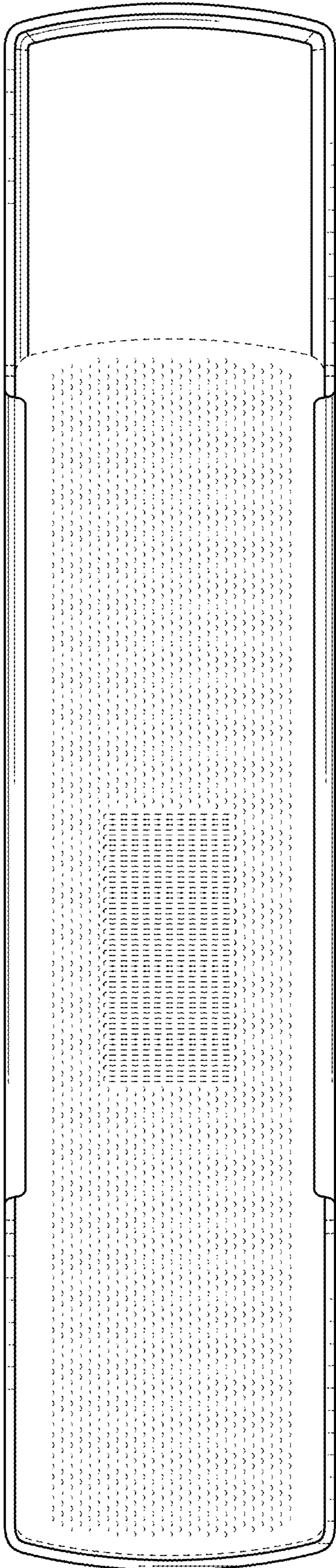

FIG. 5

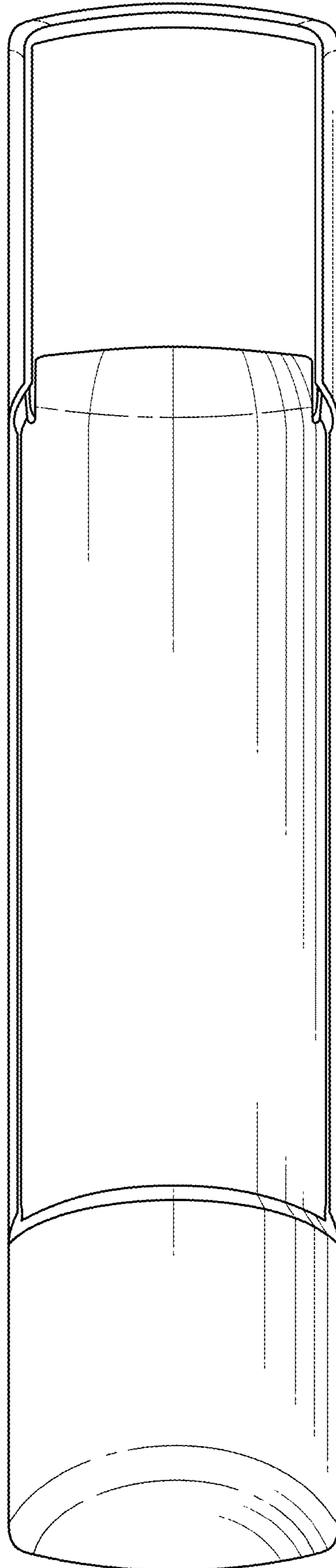

FIG. 6