



US00D944525S

(12) **United States Design Patent**
Kriesel et al.

(10) **Patent No.:** **US D944,525 S**
(45) **Date of Patent:** **** Mar. 1, 2022**

(54) **STORAGE CASE**

- (71) Applicant: **Tak Logic, LLC**, Ettrick, WI (US)
- (72) Inventors: **Matthew Kriesel**, Ettrick, WI (US);
Troy Goodenough, Ettrick, WI (US)
- (73) Assignee: **TAK LOGIC, LLC**, Ettrick, WI (US)
- (**) Term: **15 Years**
- (21) Appl. No.: **29/722,004**
- (22) Filed: **Jan. 24, 2020**

- (51) **LOC (13) Cl.** **03-01**
- (52) **U.S. Cl.**
USPC **D3/299; D3/303**

(58) **Field of Classification Search**

USPC D3/203.1–203.3, 203.6, 205, 206, 226,
D3/227, 230, 232, 242, 243, 245–247,
D3/249–251, 253, 258, 267, 268,
D3/273–276, 283–291, 294, 295,
D3/299–301, 303, 900, 901, 903;
D7/602, 605, 607, 701, 703, 709;
D9/701, 707, 709; D19/102, 106;
D27/172, 173, 180, 185–187, 189–191,
D27/193; D28/73, 76
CPC A45C 1/02; A45C 1/04; A45C 1/06; A45C
1/024; A45C 3/00; A45C 3/02; A45C
3/04; A45C 3/06; A45C 3/08; A45C
3/004; A45C 5/00; A45C 5/02; A45C
5/03; A45C 5/04; A45C 5/06; A45C
5/005; A45C 7/00; A45C 7/0036; A45C
7/0086; A45C 7/059; A45C 9/00; A45C
11/00; A45C 11/16; A45C 11/24; A45C
11/26; A45C 11/38; A45C 11/008; A45C
13/02; A45C 13/08;

(Continued)

(56) **References Cited**

U.S. PATENT DOCUMENTS

- D134,884 S * 1/1943 Engelstein D3/247
- 3,757,840 A * 9/1973 Herbener A45C 1/06
150/136

(Continued)

OTHER PUBLICATIONS

Gel-Pak MB-J-189x110B/20 (Jewelry Membrane Box with Black Frame), unknown first available date, gelpak.com [online], [site visited Jan. 11, 2021], Available at internet URL: <https://www.gelpak.com/membrane-boxes/#MB-J-80B-33> (Year: 2021).*

(Continued)

Primary Examiner — Jeffrey D Asch

Assistant Examiner — Caitlin A Laverty

(74) *Attorney, Agent, or Firm* — Polsinell PC

(57) **CLAIM**

The ornamental design for a storage case, as shown and described.

DESCRIPTION

FIG. 1 is an isometric view of a storage case showing our new design with a cover positioned in an open position and with a set of valuables positioned on an inner layer.

FIG. 2 is another isometric view thereof with the cover in a closed position and with the set of valuables positioned on the inner layer.

FIG. 3 is a front view thereof

FIG. 4 is a back view thereof.

FIG. 5 is a top view thereof.

FIG. 6 is a bottom view thereof.

FIG. 7 is a left side view thereof.

FIG. 8 is a right side view thereof; and,

FIG. 9 is an exploded view thereof.

The broken lines showing of items in the Figures is included for the purpose of illustrating environmental matter and forms no part of the claimed design. The oblique lines shown in FIGS. 1, 2, 3, and 9 illustrate transparency of the cover. The remaining shade lines in the Figures show contour and do not indicate surface ornamentation or treatment.

1 Claim, 7 Drawing Sheets

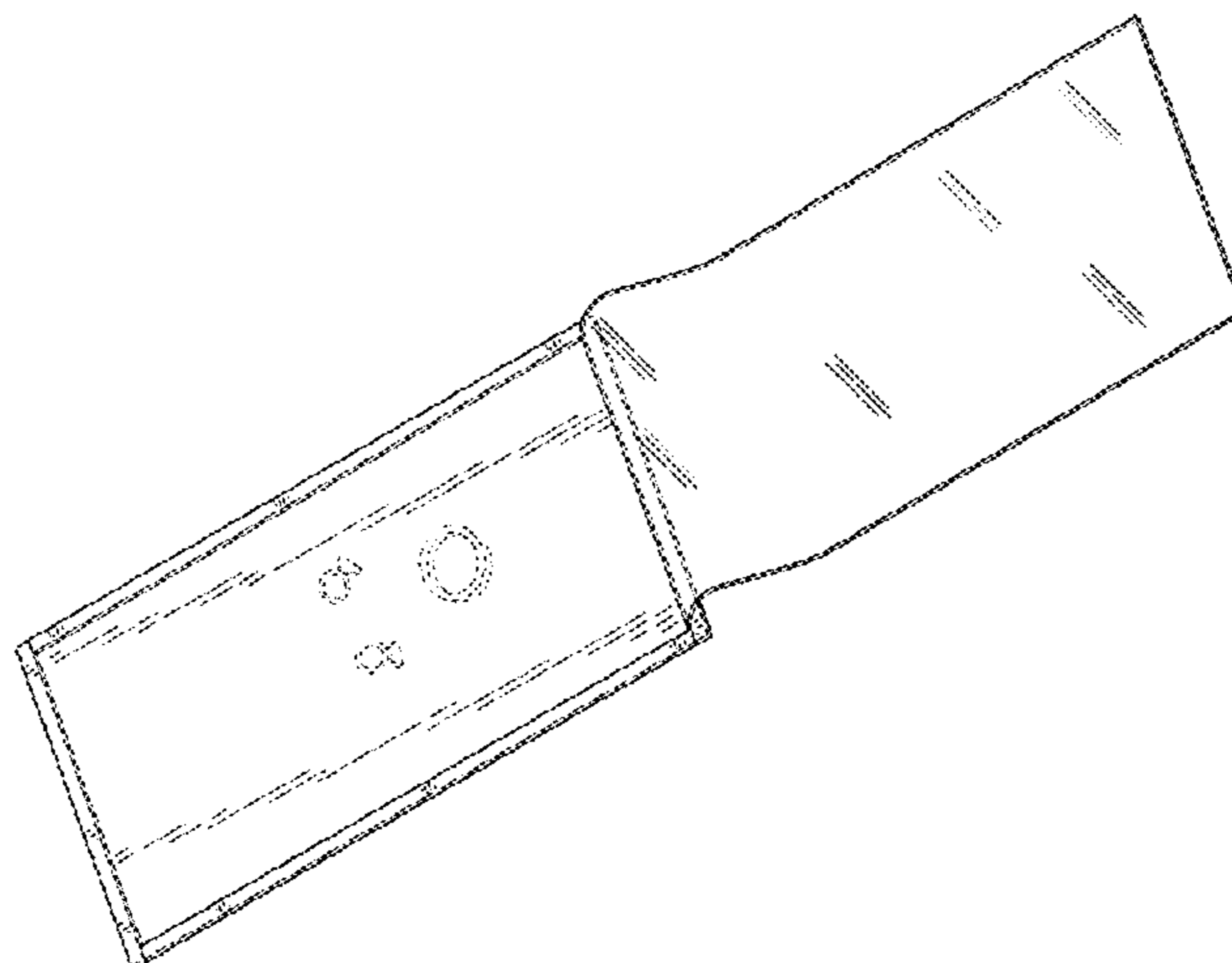

(58) **Field of Classification Search**

CPC A45C 13/26; A45C 13/30; A45C 13/185;
 A45C 15/00; A45C 2003/007; A45C
 2003/008; A45C 2011/003; A45C
 2011/007; A45C 2200/05; A45C 2200/10;
 A45F 5/00; A45F 5/02; A45F 5/021;
 A45F 2200/02; A45F 2200/0525; B65D
 75/00; B65D 85/00; B65D 85/68; B65B
 5/045

See application file for complete search history.

D805,300 S * 12/2017 Sichi D3/299
 D808,170 S * 1/2018 Goldszer D3/303
 D899,411 S * 10/2020 Liu D14/250
 2006/0201594 A1* 9/2006 Carmichael A45C 1/04
 150/143
 2011/0062045 A1* 3/2011 Kim A45C 13/02
 206/522
 2014/0325782 A1* 11/2014 O'Brien A47L 23/266
 15/215
 2016/0309010 A1* 10/2016 Carnevali H04B 1/3888
 2017/0177989 A1* 6/2017 Pascual G06K 19/07739
 2020/0113150 A1* 4/2020 Schafer A01K 1/0157
 2020/0391927 A1* 12/2020 Markarian A45C 1/02

(56) **References Cited**

U.S. PATENT DOCUMENTS

D268,714 S * 4/1983 Goedel D3/273
 4,779,655 A * 10/1988 Olson A45C 1/08
 150/112
 4,953,703 A * 9/1990 Virginio B65D 85/00
 206/451
 D546,705 S * 7/2007 Suzuki D9/415
 D595,149 S * 6/2009 Friedland G06K 19/07739
 D9/707
 D601,037 S * 9/2009 Beyer A45C 1/04
 D9/707
 D630,016 S * 1/2011 Rutjes A45C 1/08
 D3/303
 9,491,995 B1* 11/2016 Sichi B65B 5/045
 D783,415 S * 4/2017 Tran D9/707

OTHER PUBLICATIONS

MISSLO Hanging Jewelry Organizer . . . , First available Dec. 16, 2018, amazon.com [online], [site visited Jan. 12, 2021], Available at internet URL: https://www.amazon.com/MISSLO-Organizer-Foldable-Zippered-Traveling/dp/B07L6WB4Z2/ref=sr_1_38?dchild=1&keywords=jewelry+roll&qid=1610483089&sr=8-38 (Year: 2018).*
 Bead mat, rubber, translucent smoky 8x10-inch . . . , unknown first available date, firemountaingems.com [online], [site visited Oct. 7, 2021], Available at internet URL: https://www.firemountaingems.com/itemdetails/H205526BS?gclid=EAAlQobChMlg9v8ndq48wIVFablCh2mlQrpEAQYASABEgJ1RfD_BwE (Year: 2021).*

* cited by examiner

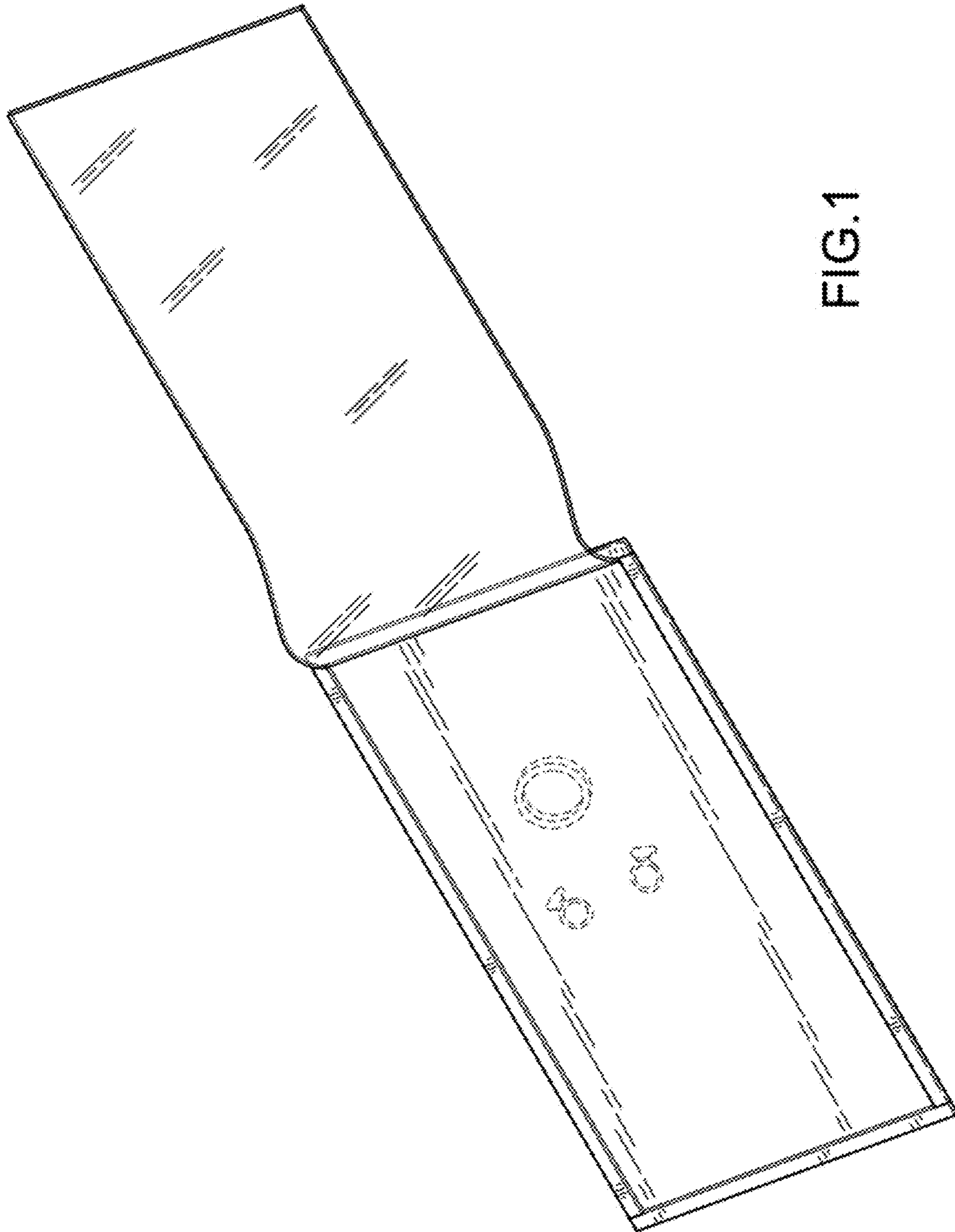

FIG. 1

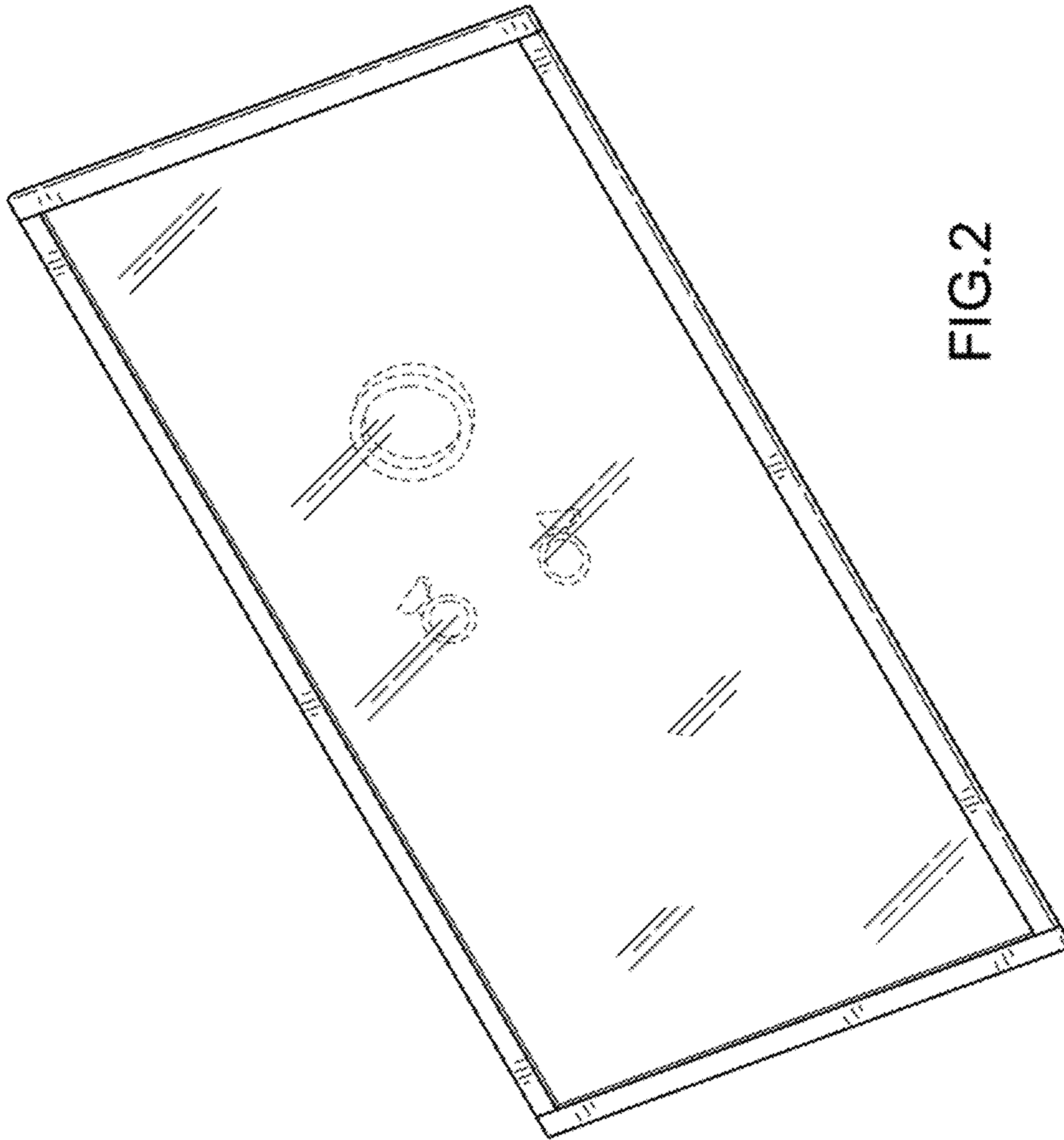

FIG. 2

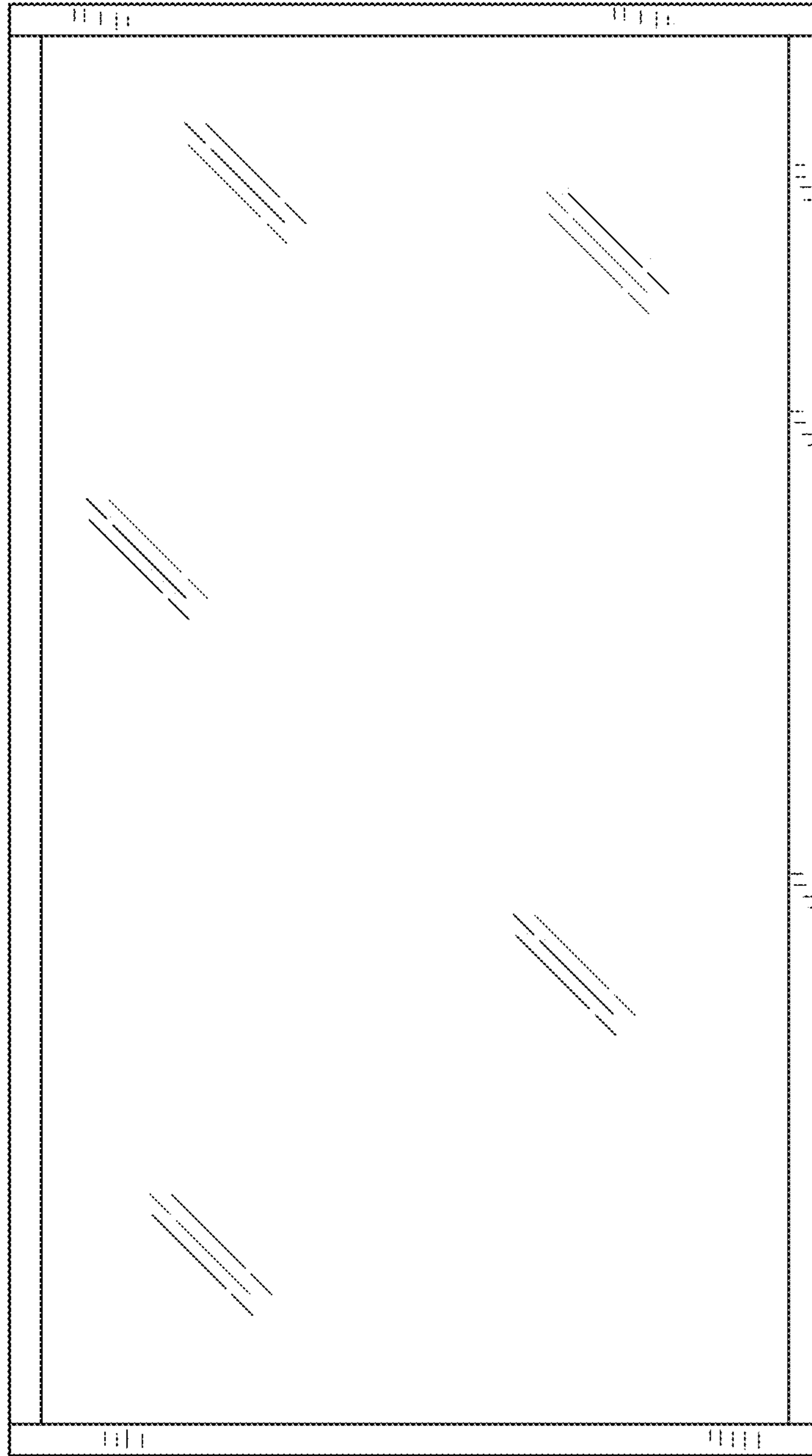

FIG.3

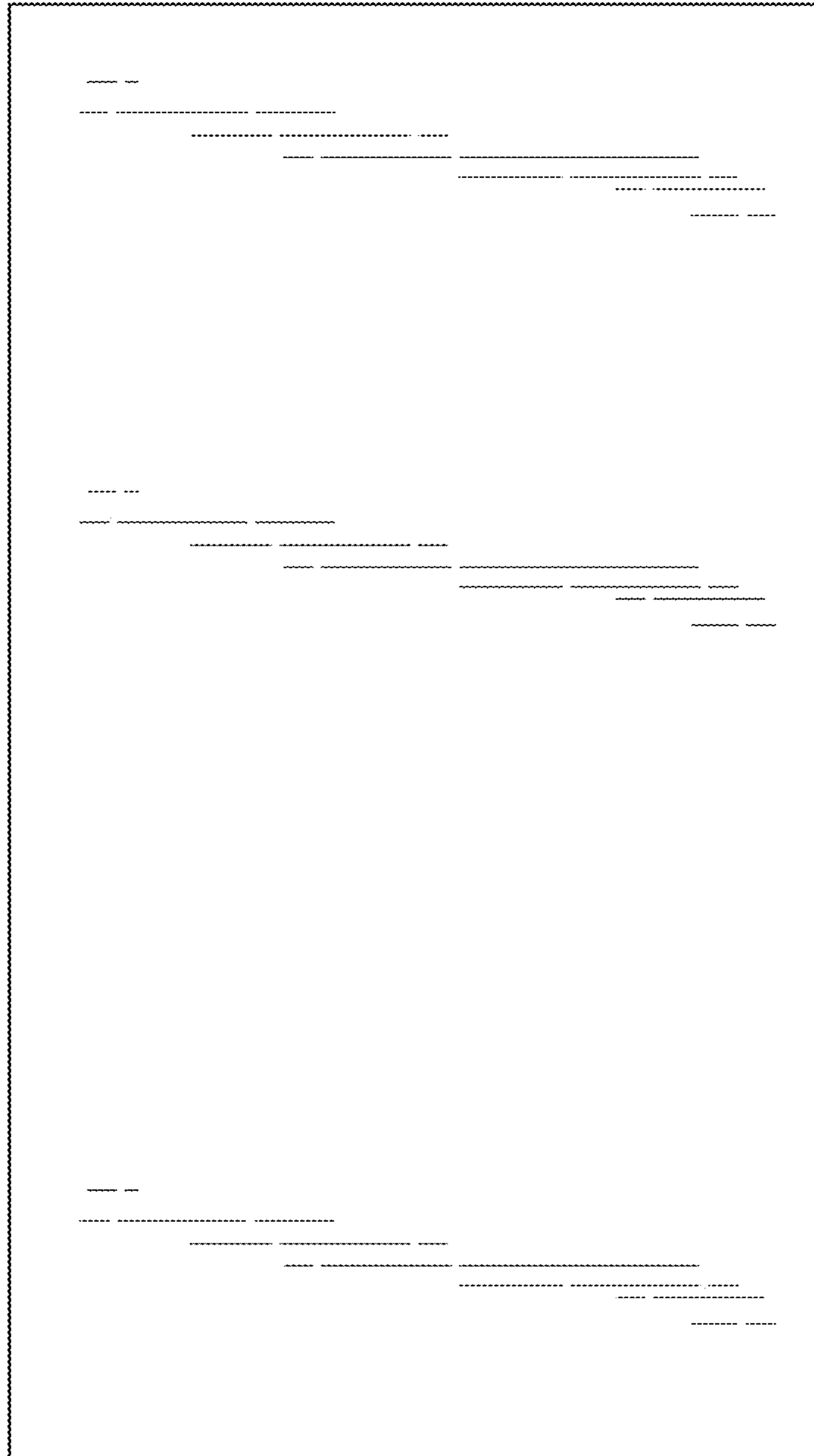

FIG.4

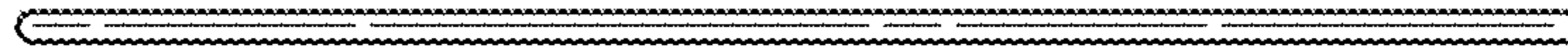

FIG. 5

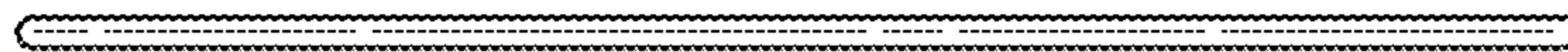

FIG. 6



FIG. 7



FIG. 8

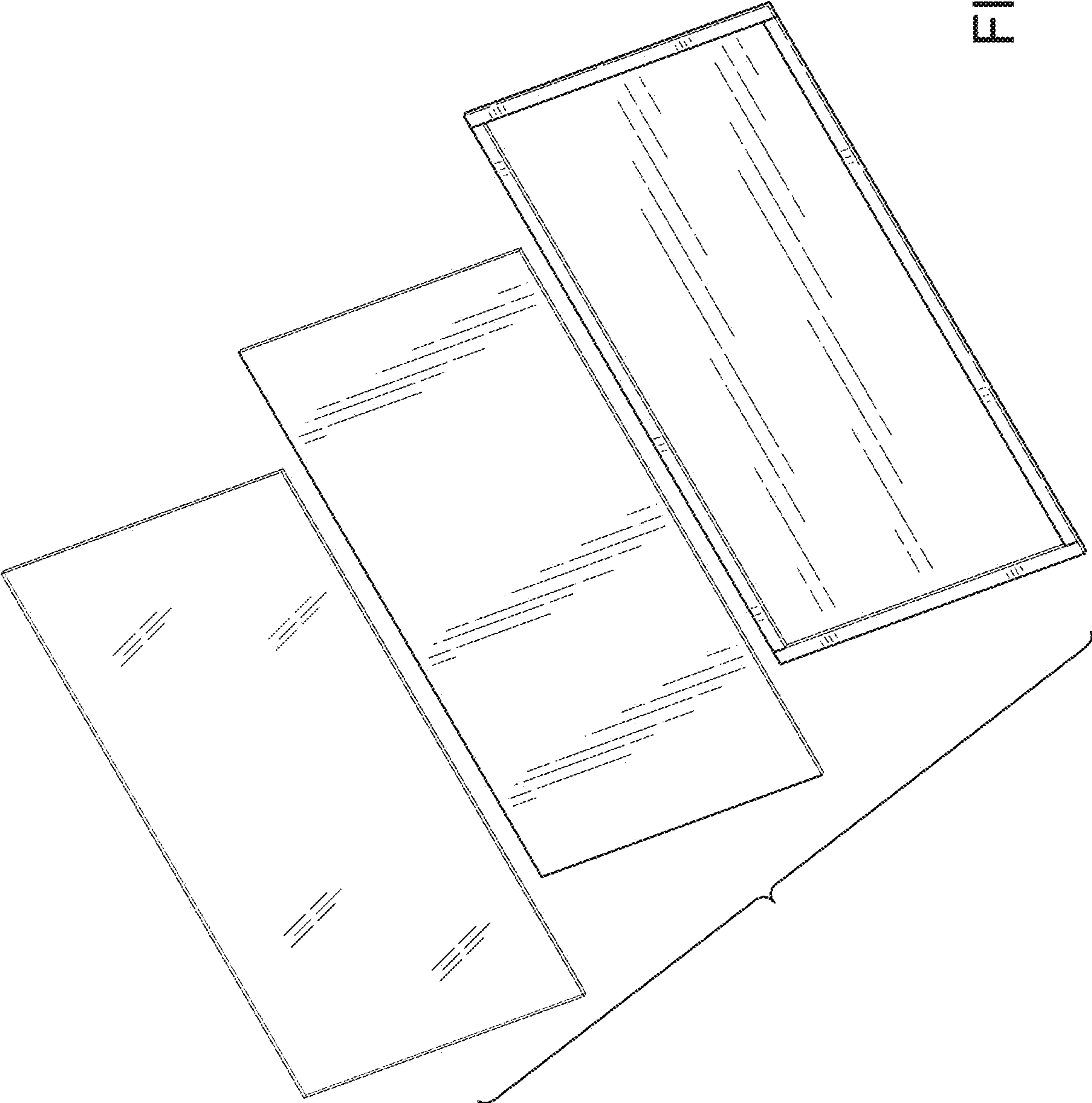

FIG. 9