



US00D944376S

(12) **United States Design Patent**  
**Bermúdez et al.**

(10) **Patent No.:** **US D944,376 S**  
(45) **Date of Patent:** **\*\* Feb. 22, 2022**

- (54) **CATALYTIC SAIL DESIGN FOR A DRY HYDROGEN PEROXIDE (DHP) GENERATING DEVICE**
- (71) Applicant: **Synexis LLC**, Overland Park, KS (US)
- (72) Inventors: **Pedro J. Bermúdez**, Olathe, KS (US);  
**Stefan Grobe**, Waldenbuch (DE)
- (73) Assignee: **Synexis LLC**, Overland Park, KS (US)
- (\*\*) Term: **15 Years**
- (21) Appl. No.: **29/723,874**
- (22) Filed: **Feb. 11, 2020**
- (51) **LOC (13) Cl.** ..... **23-04**
- (52) **U.S. Cl.**  
USPC ..... **D23/355**
- (58) **Field of Classification Search**  
USPC ..... D23/355–366, 352, 369, 332, 333, 335,  
D23/336, 342, 351; 422/120, 122;  
55/356, 473, 504; 96/97; 261/DIG. 17,  
261/DIG. 65, DIG. 88, DIG. 31;  
D12/193; 40/206  
CPC ... A61L 2/208; A61L 9/16; A61L 9/22; B01D  
47/00; B01D 47/027; B01D 2221/02;  
B01D 2259/4508; B03C 3/155; B03C  
3/368; F24F 3/16; F24F 13/20  
See application file for complete search history.

(56) **References Cited**

U.S. PATENT DOCUMENTS

- 4,553,992 A \* 11/1985 Boissinot ..... A61L 9/16  
126/299 D
- 5,348,691 A \* 9/1994 McElroy ..... F24F 3/14  
261/36.1
- 5,690,719 A \* 11/1997 Hodge ..... B01D 46/0005  
96/17

- 5,824,126 A \* 10/1998 Chen ..... B01D 46/10  
55/501
- 7,691,165 B1 \* 4/2010 Hammes ..... B01D 46/0002  
55/495
- 8,168,122 B2 \* 5/2012 Lee ..... A61L 2/208  
422/120
- 9,114,356 B2 \* 8/2015 Gurman ..... B03C 3/38
- D814,006 S \* 3/2018 Bosma ..... D23/355
- D890,898 S \* 7/2020 Nibbelink ..... D23/355
- D896,360 S \* 9/2020 Guilliard ..... D23/351
- D896,362 S \* 9/2020 Riley ..... D23/366
- 2003/0102106 A1 \* 6/2003 Moilala ..... F24F 12/001  
165/4
- 2004/0172927 A1 \* 9/2004 Lee ..... F24F 13/28  
55/495
- 2007/0012192 A1 \* 1/2007 Pippel ..... B01D 46/0005  
96/417
- 2015/0217018 A1 \* 8/2015 Sanchez Tavora ..... F24F 8/192  
422/114
- 2015/0273985 A1 \* 10/2015 Luley ..... B60H 3/0658  
96/134
- 2020/0114032 A1 \* 4/2020 Spencer ..... A61B 50/00

*Primary Examiner* — David G Muller

(74) *Attorney, Agent, or Firm* — Arnold & Porter Kaye Scholer

(57) **CLAIM**

The ornamental design for a catalytic sail for a dry hydrogen peroxide (DHP) generating device, as shown and described.

**DESCRIPTION**

FIG. 1 is a perspective view of catalytic sail for use in a dry hydrogen peroxide (DHP) generating device of the present application.

FIG. 2 is a front view of the catalytic sail of FIG. 1.

FIG. 3 is a back view of the catalytic sail of FIG. 1.

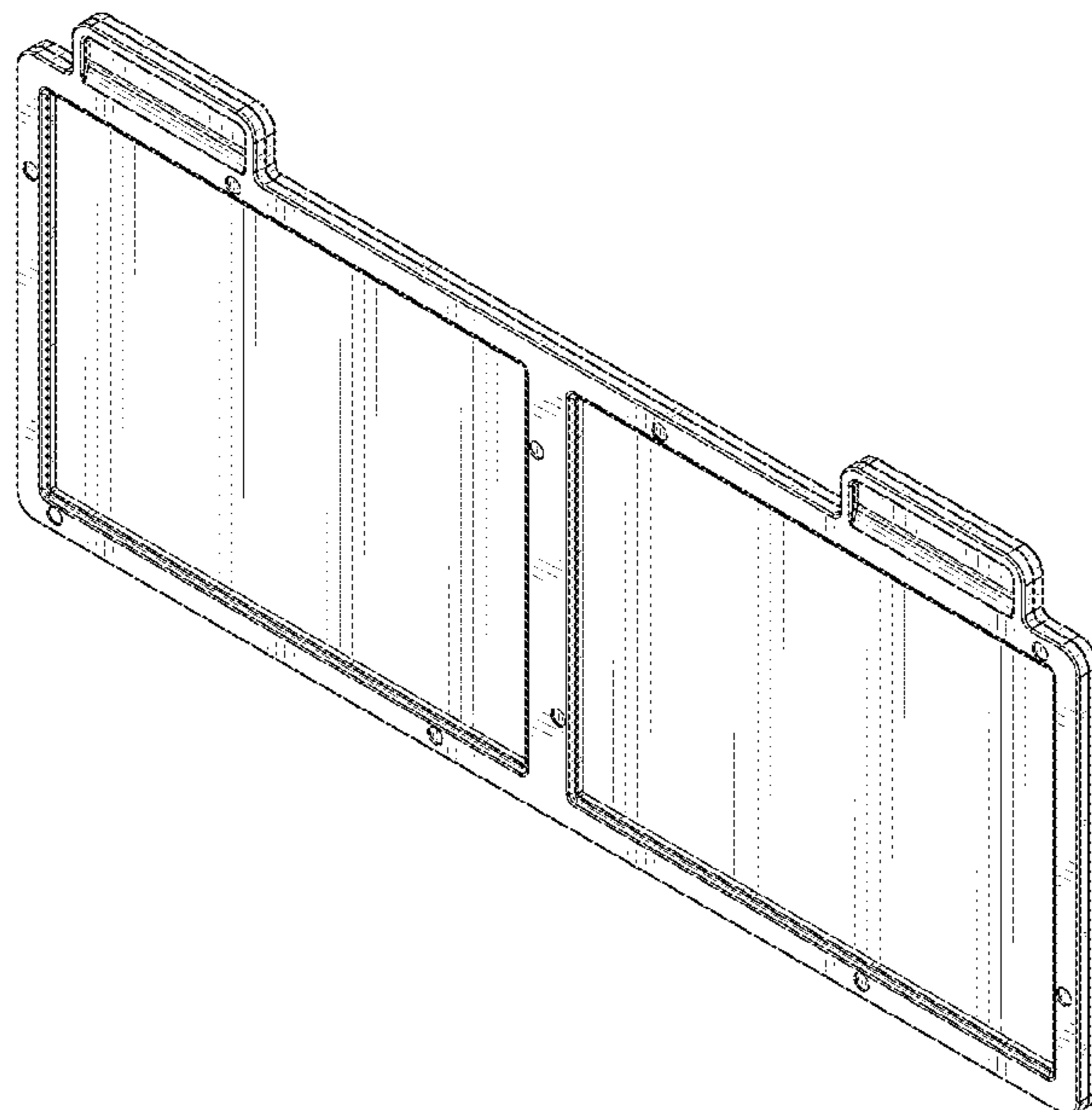
FIG. 4 is a left side view of the catalytic sail of FIG. 1.

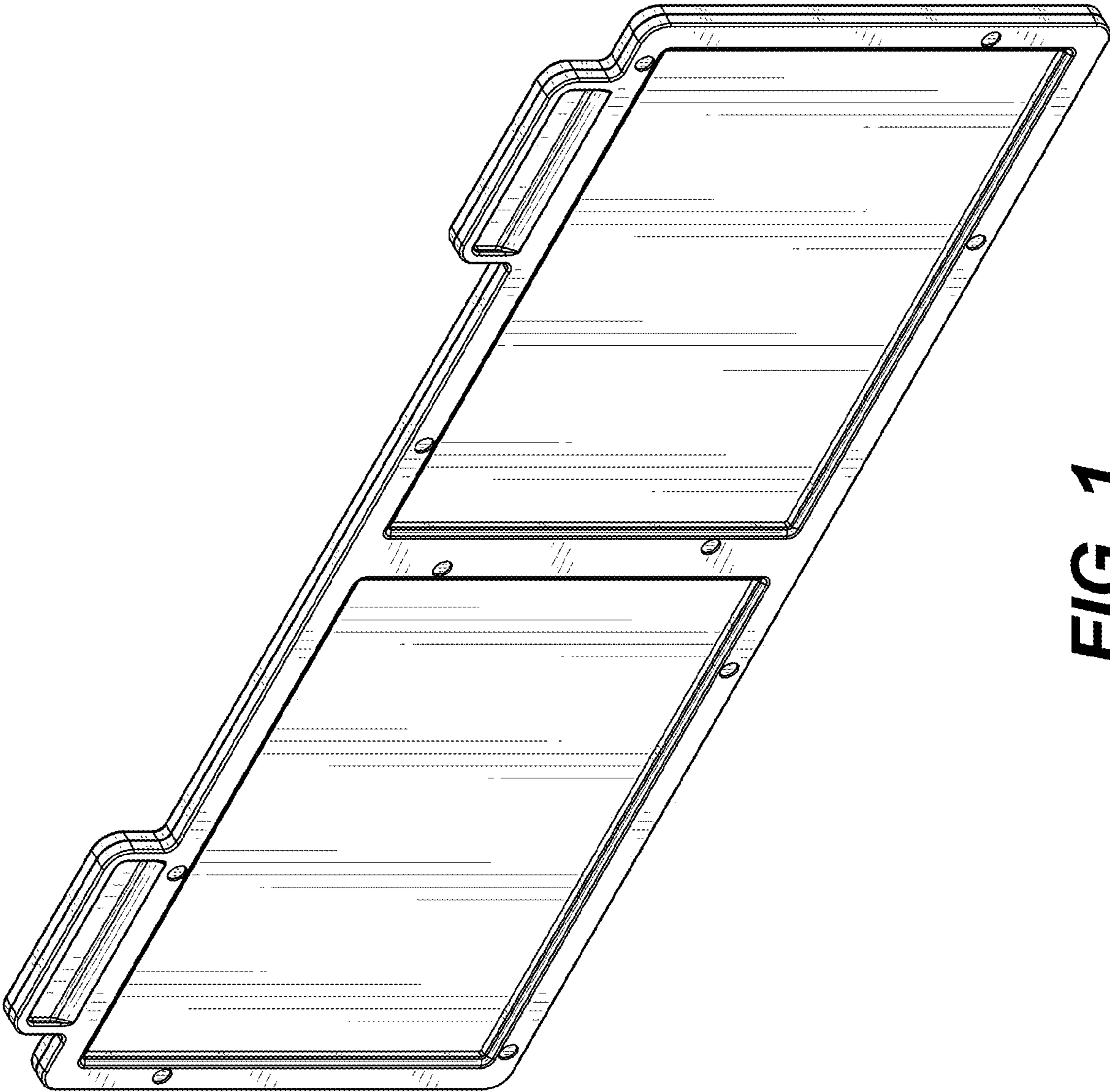
FIG. 5 is a right side view of the catalytic sail of FIG. 1.

FIG. 6 is a top view of the catalytic sail of FIG. 1; and,

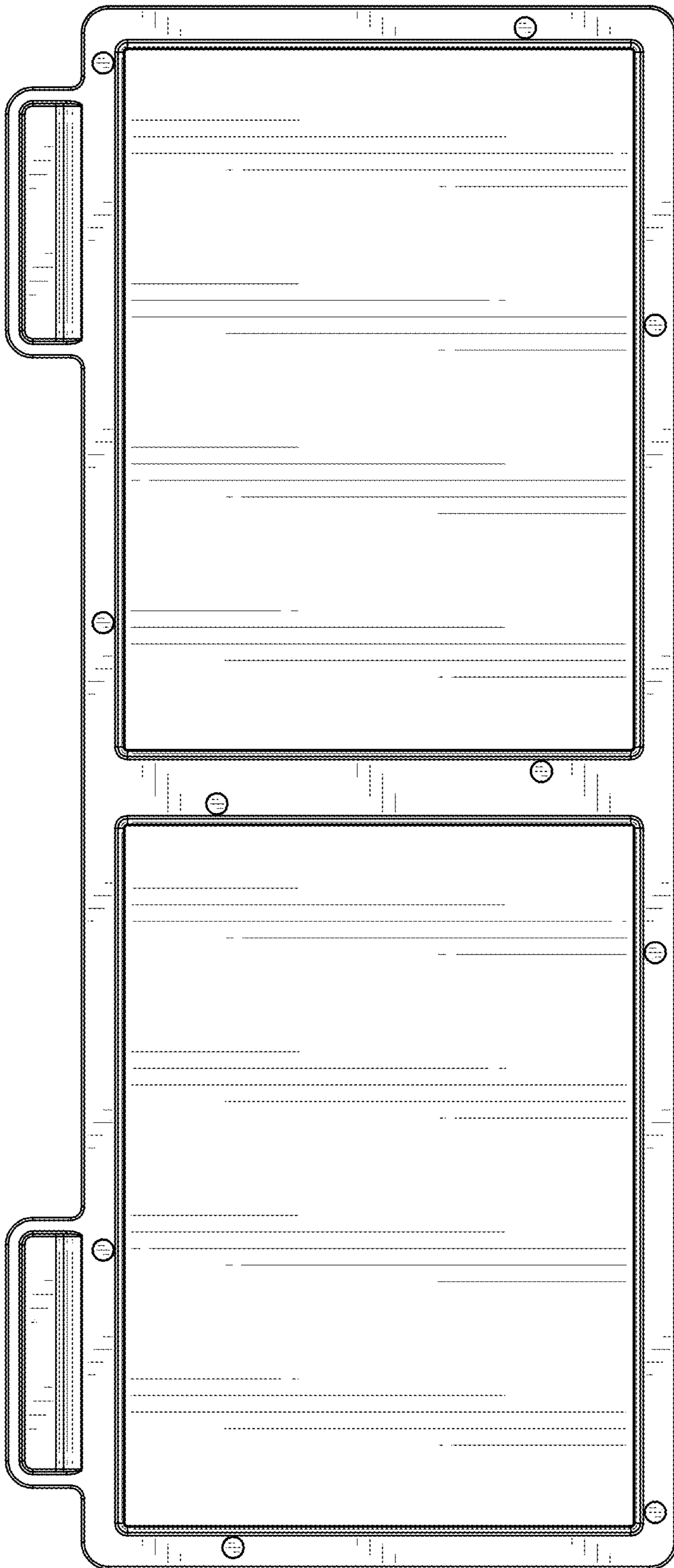
FIG. 7 is bottom view of the de catalytic sail vice of FIG. 1.

**1 Claim, 7 Drawing Sheets**

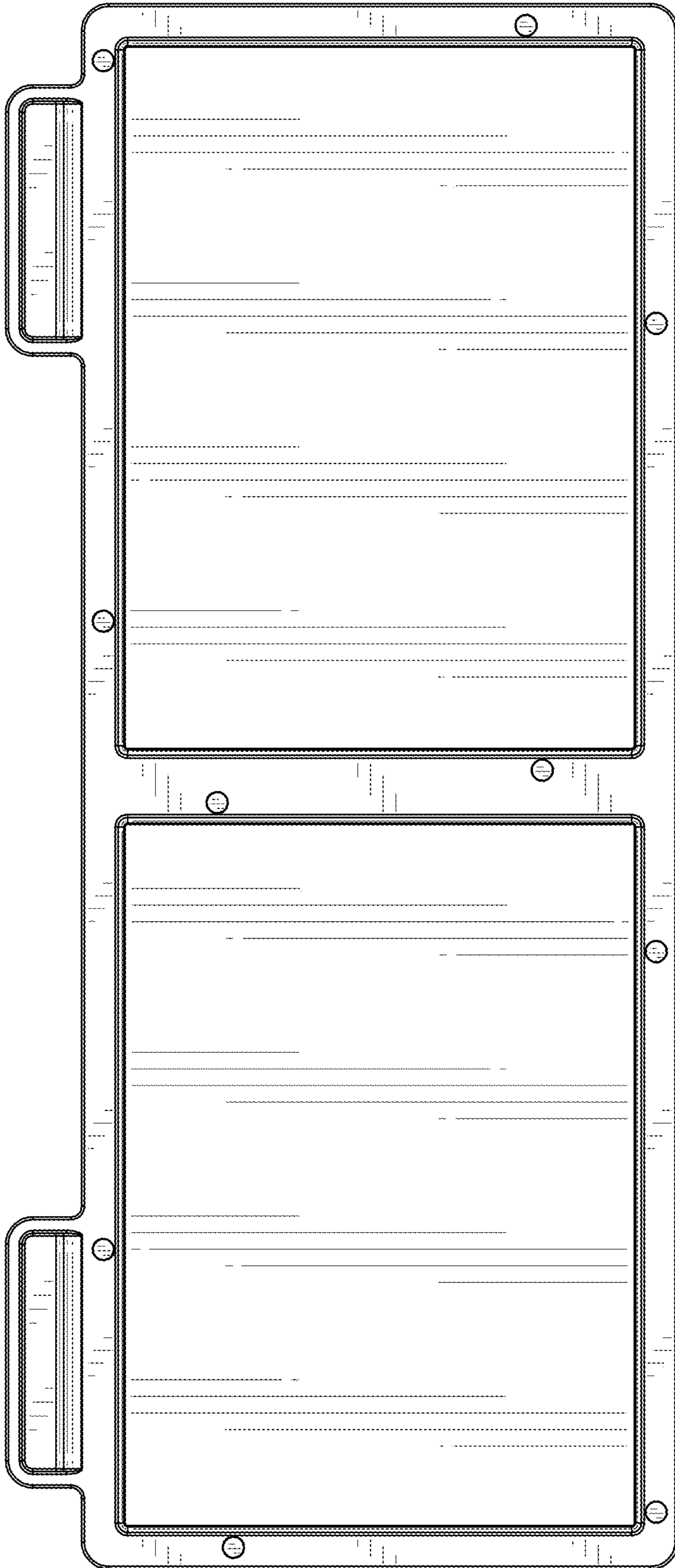




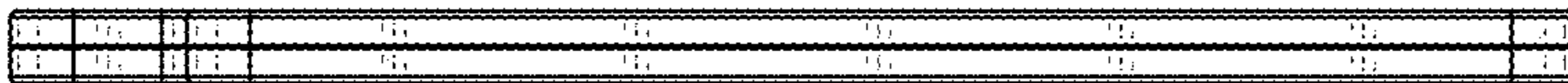
**FIG. 1**



**FIG. 2**



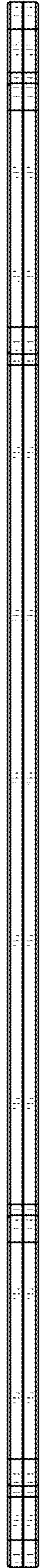
**FIG. 3**



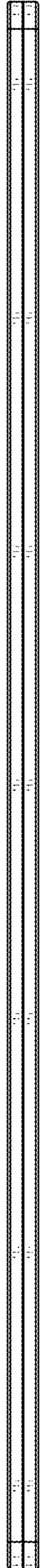
**FIG. 4**



**FIG. 5**



**FIG. 6**



**FIG. 7**