



US00D944322S

(12) **United States Design Patent** (10) **Patent No.:** **US D944,322 S**
Lowe et al. (45) **Date of Patent:** **** Feb. 22, 2022**

(54) **LAYER OF A TRANSACTION CARD**

(56) **References Cited**

(71) Applicant: **CompoSecure, LLC**, Somerset, NJ (US)

U.S. PATENT DOCUMENTS

(72) Inventors: **Adam Lowe**, Somerset, NJ (US);
Michele Logan, Madison, NJ (US);
Dori Skelding, North Plainfield, NJ (US);
Syeda Hussain, Somerset, NJ (US)

3,802,101 A	4/1974	Scantlin
4,737,620 A	4/1988	Mollet et al.
5,013,900 A	5/1991	Hoppe
5,350,553 A	9/1994	Gläser et al.
5,463,953 A	11/1995	Kaspers et al.
5,574,309 A	11/1996	Papapietro et al.
5,598,032 A	1/1997	Fidalgo
5,681,356 A	10/1997	Barak et al.
5,774,339 A	6/1998	Ohbuchi et al.
D405,450 S	2/1999	Niitsu
5,935,497 A	8/1999	Rose
5,962,840 A	10/1999	Haghiri-Tehrani et al.
6,065,681 A	5/2000	Trueggelmann
6,188,580 B1	2/2001	Huber et al.
6,724,103 B2	4/2004	Parrault
6,817,532 B2	11/2004	Finkelstein
D529,955 S	10/2006	Allard et al.
7,237,724 B2	7/2007	Singleton
D573,182 S	7/2008	Ricketts et al.
7,701,350 B2	4/2010	Sakama et al.
7,762,470 B2	7/2010	Finn et al.
7,823,777 B2	11/2010	Varga
D632,735 S	2/2011	McGrane et al.
7,936,273 B2	5/2011	Kobayashi et al.
7,954,228 B2	6/2011	Kobayashi et al.
8,128,000 B2	3/2012	Forster
8,141,786 B2	3/2012	Bhandarkar et al.
8,174,454 B2	5/2012	Mayer
8,226,013 B2	7/2012	Phillips et al.
8,248,240 B2	8/2012	Osaki et al.
8,261,997 B2	9/2012	Gebhart
8,448,872 B2	5/2013	Droz
8,519,905 B2	8/2013	Tanaka et al.
8,608,082 B2	12/2013	Le Garrec et al.
8,622,311 B2	1/2014	Hamedani et al.
8,698,633 B2	4/2014	Kobayashi et al.
8,725,589 B1	5/2014	Skelding et al.
8,786,510 B2	7/2014	Coleman et al.
8,789,762 B2	7/2014	Finn
8,978,987 B2	3/2015	Scarlatella
9,000,619 B2	4/2015	Kato et al.
9,058,547 B2	6/2015	Oh et al.
9,099,789 B1	8/2015	Modra
9,251,458 B2	2/2016	Finn et al.
9,320,186 B2	4/2016	Droz
9,390,364 B2	7/2016	Finn et al.
9,390,366 B1	7/2016	Herslow et al.
9,475,086 B2	10/2016	Finn et al.
D771,186 S	11/2016	Canaday et al.

(73) Assignee: **COMPOSECURE, LLC**, Somerset, NJ (US)

(**) Term: **15 Years**

(21) Appl. No.: **29/732,680**

(22) Filed: **Apr. 27, 2020**

Related U.S. Application Data

(63) Continuation of application No. 15/928,813, filed on Mar. 22, 2018, now Pat. No. 10,762,412.

(51) **LOC (13) Cl.** **19-08**

(52) **U.S. Cl.**
USPC **D19/10**

(58) **Field of Classification Search**
USPC D19/1-12, 20-34, 100;
40/124.01-124.15, 672, 661, 726, 776,
40/617; 283/72, 74-75, 103, 105-117,
283/81-82, 70, 94, 904; 206/449, 815;
D21/385; D20/10, 22, 27, 40, 42, 11;
D14/435-437; D6/613, 583; 362/2;
235/380, 382, 487, 493, 488
CPC .. B42D 15/022; B42D 15/045; B42D 15/027;
B42D 15/042; B42D 25/29; B42D 25/00;
B42D 25/20; B42D 25/30; B42D 25/40;
B42D 25/23; B42D 25/26; B42D 25/285;
B42D 2033/00; B42D 2033/08; B42D
2033/10; B42D 2033/16; B42D 2033/20;
B42D 2033/30

See application file for complete search history.

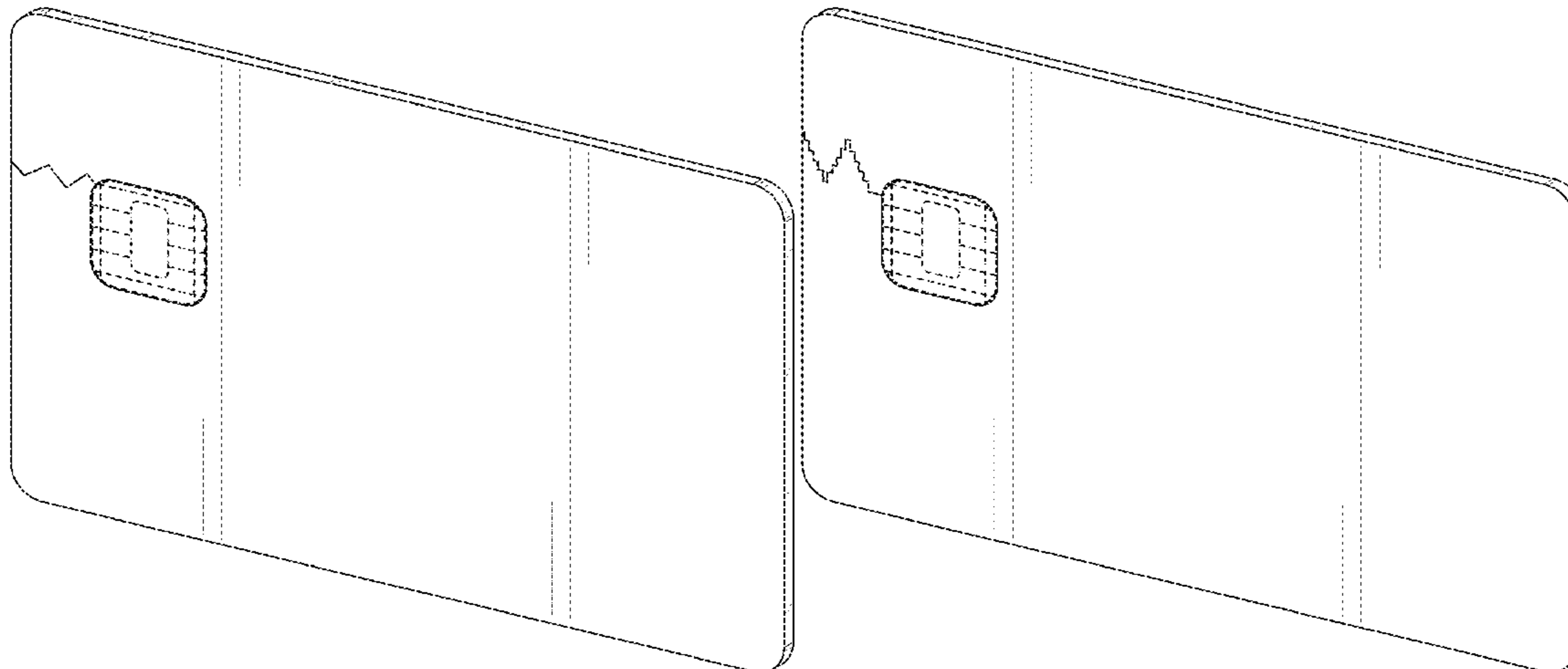

US D944,322 S

9,489,613	B2	11/2016	Finn et al.	
9,622,359	B2	4/2017	Finn et al.	
9,634,391	B2	4/2017	Finn et al.	
9,697,459	B2	7/2017	Finn et al.	
9,721,200	B2	8/2017	Herslow et al.	
D797,188	S	9/2017	Hendrick	
9,760,816	B1	9/2017	Williams et al.	
9,798,968	B2	10/2017	Finn	
9,812,782	B2	11/2017	Finn et al.	
9,836,684	B2	12/2017	Finn et al.	
9,898,699	B2	2/2018	Herslow et al.	
D812,137	S	3/2018	Daniel et al.	
10,032,099	B2	7/2018	Mosteller	
10,089,570	B2	10/2018	Herslow et al.	
10,140,569	B2	11/2018	Kim et al.	
10,147,999	B2	12/2018	Wang et al.	
10,193,211	B2	1/2019	Finn et al.	
10,339,434	B2	7/2019	Cox	
D864,293	S *	10/2019	Lowe	G06K 19/0723 D19/10
10,445,627	B1	10/2019	Sexl et al.	
10,583,683	B1	3/2020	Ridenour et al.	
2003/0102541	A1	6/2003	Gore et al.	
2005/0087609	A1	4/2005	Martin	
2006/0102729	A1	5/2006	Gandel et al.	
2006/0226240	A1	10/2006	Singleton	
2007/0034700	A1	2/2007	Poidomani et al.	
2007/0290048	A1	12/2007	Singleton et al.	
2008/0001759	A1	1/2008	Kobayashi et al.	
2009/0031954	A1	2/2009	Williams	
2011/0024036	A1	2/2011	Benato	
2011/0315779	A1	12/2011	Bidin et al.	
2012/0044693	A1	2/2012	Hatase et al.	
2012/0201994	A1	8/2012	Michalk	
2012/0206869	A1	8/2012	Droz	
2013/0062875	A1	3/2013	Le Loarer et al.	
2013/0102113	A1	4/2013	Yang	
2013/0228628	A1	9/2013	Bona et al.	
2013/0247432	A1	9/2013	Droz	
2013/0255078	A1	10/2013	Cox	
2013/0299593	A1	11/2013	Glidden, III	
2014/0153773	A1	6/2014	Blum	
2014/0279555	A1	9/2014	Guillaud	
2014/0283978	A1	9/2014	Droz	
2014/0361086	A1	12/2014	Finn et al.	
2015/0021403	A1	1/2015	Finn et al.	
2015/0097040	A1	4/2015	Rampetzreiter et al.	
2015/0129665	A1	5/2015	Finn et al.	
2015/0136858	A1	5/2015	Finn et al.	
2015/0180229	A1	6/2015	Herslow	
2015/0206047	A1	7/2015	Herslow et al.	
2015/0235063	A1	8/2015	Loussert	
2015/0235122	A1	8/2015	Finn et al.	
2015/0239202	A1	8/2015	Purdy et al.	
2015/0269474	A1	9/2015	Finn et al.	
2015/0269477	A1	9/2015	Finn et al.	
2015/0278675	A1	10/2015	Finn et al.	
2015/0339564	A1	11/2015	Herslow et al.	
2016/0110639	A1	4/2016	Finn et al.	
2016/0203399	A1	7/2016	Cox	
2016/0229081	A1	8/2016	Williams et al.	
2016/0365644	A1	12/2016	Finn et al.	
2017/0017871	A1	1/2017	Finn et al.	
2017/0077589	A1	3/2017	Finn et al.	
2017/0106572	A1	4/2017	Cepress et al.	
2017/0243099	A1	8/2017	Kluge	
2017/0243104	A1	8/2017	Cox	
2017/0262749	A1	9/2017	Cox	
2017/0308785	A1	10/2017	Kim et al.	
2017/0316300	A1	11/2017	Herslow et al.	
2017/0316303	A1	11/2017	Pachler et al.	
2017/0323193	A1	11/2017	Kitney et al.	
2018/0068212	A1	3/2018	Williams et al.	
2018/0123221	A1	5/2018	Finn	
2018/0157954	A1	6/2018	Herslow et al.	
2018/0204105	A1	7/2018	Herslow et al.	
2018/0307962	A1	10/2018	Lowe et al.	
2018/0339503	A1	11/2018	Finn et al.	
2018/0341846	A1	11/2018	Finn et al.	

2018/0341847	A1	11/2018	Finn et al.
2018/0349751	A1	12/2018	Herslow et al.
2019/0050706	A1	2/2019	Lowe
2019/0114526	A1	4/2019	Finn et al.
2019/0130242	A1	5/2019	Fu et al.
2019/0156073	A1	5/2019	Finn et al.
2019/0156994	A1	5/2019	Cox
2019/0197381	A1	6/2019	Cox
2019/0204812	A1	7/2019	Cox
2019/0206161	A1	7/2019	Cox
2019/0236434	A1	8/2019	Lowe
2019/0279065	A1	9/2019	Cox
2019/0300695	A1	10/2019	Cox

FOREIGN PATENT DOCUMENTS

CA	2347818	A1	5/2000
CA	2860909	A1	8/2013
CN	100397406	C	6/2008
DE	19703122	C1	5/1998
DE	19848193	C1	11/1999
DE	19934434	A1	2/2001
DE	10132893	A1	1/2003
DE	102007016777	A1	10/2008
DE	102008053582	B3	4/2010
EP	0277854	A1	8/1988
EP	0426406	A2	5/1991
EP	2133828	A2	12/2009
EP	2722193	A1	4/2014
EP	2765648	A1	8/2014
EP	3009964	A1	4/2016
GN	103153640	A	6/2013
JP	61222715	A	10/1986
JP	63072596	A	4/1988
JP	63185688	A	8/1988
JP	63239097	A	10/1988
JP	021397	A	1/1990
JP	02055198	A	2/1990
JP	03205197	A	9/1991
JP	0564861	A	3/1993
JP	07501758	A	2/1995
JP	08276459	A	10/1996
JP	09315053	A	12/1997
JP	10291392	A	11/1998
JP	1111056	A	1/1999
JP	2003234615	A	8/2003
JP	2004094561	A	3/2004
JP	2007021830	A	2/2007
KR	20010080890	A	8/2001
KR	20140117614	A	10/2014
KR	20170061572	A	6/2017
KR	20170120524	A	10/2017
TW	201723933	A	7/2017
WO	9809252	A1	3/1998
WO	2008105582	A1	9/2008
WO	2013110625	A1	8/2013
WO	2015071017	A1	5/2015
WO	2015071086	A1	5/2015
WO	2015144261	A1	10/2015
WO	2016020067	A1	2/2016
WO	2016046184	A1	3/2016
WO	2016073473	A1	5/2016
WO	2017007468	A1	1/2017
WO	2017090891	A1	6/2017
WO	2017177906	A1	10/2017
WO	2018022755	A1	2/2018
WO	2018132404	A1	7/2018
WO	2018138432	A1	8/2018
WO	2018202774	A	11/2018

OTHER PUBLICATIONS

Chinese Office Action for Chinese Application No. 201780046491, 5, dated Jul. 5, 2021 with translation, 16 pages.
 Indian Examination Report for Indian Application No. 202017013311, dated Jul. 8, 2021 with translation, 6 pages.
 Singapore Written Opinion for Application No. 11202003431Y, dated Apr. 22, 2021, 7 pages.

International Search Report and Written Opinion for International Application No. PCT/US2021/013796, dated May 11, 2021, 22 pages.

Notice of Termination of Pretrial Reexamination for Japanese Application No. 2019-504037, dated May 18, 2021 with translation, 2 pages.

Report of Pretrial Reexamination of Japanese Application No. 2019-504037, dated May 12, 2021 with translation, 5 pages.

Japanese Notice of Reasons for Rejection for Japanese Application No. 2020-522026, dated May 25, 2021 with translation, 8 pages.

Non Final Office Action for U.S. Appl. No. 16/751,285, dated Jan. 25, 2021, 51 pages.

Non Final Office Action for U.S. Appl. No. 16/124,711, dated May 1, 2020, 31 pages.

Korean Office Action for Korean Application No. 10-2019-7005614, dated Apr. 17, 2020 with translation, 14 pages.

International Preliminary Report on Patentability for International Application No. PCT/US2018/052832, dated Apr. 21, 2020, 9 pages.

International Preliminary Report on Patentability for International Application No. PCT/US2018/049899, dated Mar. 10, 2020, 8 pages.

Japanese Notice of Reasons for Rejection for Japanese Application No. 2019-504037, dated Mar. 10, 2020 with translation, 7 pages.

International Search Report and Written Opinion for International Application No. PCT/US2019/014656, dated Apr. 1, 2019, 16 pages.

Third Party Submission Under 37 CFR 1.290 Concise Statement of Relevance, dated Oct. 15, 2019, 13 pages.

Third Party Submission Under 37 CFR 1.290 filed in U.S. Appl. No. 15/928,813 Concise Description of Relevance dated Nov. 1, 2019, 8 pages.

Third Party Submission Under 37 CFR 1.290 filed In U.S. Appl. No. 15/928,813 Concise Description of Relevance dated Oct. 27, 2019, 13 pages.

International Preliminary Report on Patentability for International Application No. PCT/US2017/043954, dated Jan. 29, 2019, 6 pages.

International Search Report and Written Opinion for International Application No. PCT/US2017/043954, dated Oct. 5, 2017—6 pages.

Non Final Office Action for U.S. Appl. No. 16/441,363, dated Aug. 8, 2019, 23 pages.

Final Office Action for U.S. Appl. No. 16/164,322, dated Apr. 11, 2019—20 pages.

International Search Report and Written Opinion for International Application No. PCT/US2019/056704, dated Dec. 18, 2019, 11 pages.

Non Final Office Action for U.S. Appl. No. 29/663,230, dated Jul. 25, 2019, 19 pages.

Chen et al., “A Metallic RFID Tag Design for Steel-Bar and Wire-Rod Management Application in the Steel Industry”, Progress in Electromagnetics Research, PIER 91, 2009, pp. 195-212.

International Search Report and Written Opinion for International Application No. PCT/US2020/034661, dated Sep. 1, 2020, 16 pages.

European Communication Pursuant to Article 94(3) for European Application No. 17835207.6, dated Oct. 23, 2020, 6 pages.

Extended European Search Report for European Application No. 17835207.6, dated Mar. 10, 2020, 12 pages.

Non Final Office Action for U.S. Appl. No. 16/124,711, dated Oct. 15, 2020, 38 pages.

Final Office Action for U.S. Appl. No. 16/124,711, dated Aug. 7, 2020, 18 pages.

Japanese Decision of Final Rejection for Japanese Application No. 2019-504037, dated Oct. 6, 2020 with translation, 5 pages.

Non Final Office Action for U.S. Appl. No. 15/928,813, dated Apr. 15, 2020, 51 pages.

Korean Notice to File a Response for Korean Application No. 30-2020-0042662, dated Sep. 12, 2020 with translation, 3 pages.

Non Final Office Action for U.S. Appl. No. 16/427,864, dated Nov. 4, 2020, 56 pages.

Notice of Allowance for Application No. 14/783,504, dated Nov. 13, 2020, 12 pages.

Canadian Examination Report for Canadian Application No. 3,088,900, dated Apr. 8, 2021, 6 pages.

Non Final Office Action for U.S. Appl. No. 16/320,597, dated Apr. 13, 2021, 74 pages.

International Preliminary Report on Patentability for International Application No. PCT/US2019/056704, dated Apr. 14, 2021, 7 pages.

Australian Examination Report for Australian Application No. 2019213838, dated Jun. 29, 2021, 8 pages.

Japanese Notice of Reasons for Rejection for Japanese Application No. 2020-541522, dated May 31, 2021 with translation, 7 pages.

Non Final Office Action for U.S. Appl. No. 17/128,427, dated Jun. 29, 2021, 53 pages.

Ex Parte Quayle Office Action for U.S. Appl. No. 29/732,684, dated Aug. 18, 2021, 52 pages.

Non Final Office Action for U.S. Appl. No. 17/101,092, dated Sep. 16, 2021, 54 pages.

Ex Parte Quayle Office Action for U.S. Appl. No. 29/732,679, dated Sep. 15, 2021, 42 pages.

Ex Parte Quayle Office Action for U.S. Appl. No. 29/732,682, dated Sep. 15, 2021, 56 pages.

Ex Parte Quayle Office Action for U.S. Appl. No. 29/732,683, dated Sep. 15, 2021, 72 pages.

Final Office Action for U.S. Appl. No. 17/128,427, dated Oct. 5, 2021, 16 pages.

Non Final Office Action for U.S. Appl. No. 17/101,096, dated Oct. 15, 2021, 59 pages.

Taiwan Office Action for Taiwan Application No. 109117975, dated Sep. 24, 2021 with translation, 22 pages.

Non Final Office Action for U.S. Appl. No. 17/128,427, dated Dec. 15, 2021, 20 pages.

Taiwan Office Action for Taiwan Application No. 110102065, dated Dec. 1, 2021 with Search Report.

* cited by examiner

Primary Examiner — Abraham Bahta
(74) *Attorney, Agent, or Firm* — RatnerPrestia

(57) **CLAIM**

The ornamental design for a layer of a transaction card, as shown and described.

DESCRIPTION

FIG. 1 is a front isometric view of a layer of a transaction card according to a first exemplary embodiment of the present invention;

FIG. 2 is a front elevation view thereof;

FIG. 3 is a rear elevation view thereof;

FIG. 4 is an elevation view thereof taken from the left side;

FIG. 5 is an elevation view thereof taken from the right side;

FIG. 6 is a top plan view thereof;

FIG. 7 is a bottom plan view thereof; and

FIG. 8 is an enlarged view of a portion of FIG. 4.

FIG. 9 is a front isometric view of a layer of a transaction card according to a second exemplary embodiment of the present invention;

FIG. 10 is a front elevation view thereof;

FIG. 11 is a rear elevation view thereof;

FIG. 12 is an elevation view thereof taken from the left side;

FIG. 13 is an elevation view thereof taken from the right side;

FIG. 14 is a top plan view thereof;

FIG. 15 is a bottom plan view thereof; and

FIG. 16 is an enlarged view of a portion of FIG. 12.

FIG. 17 is a front isometric view of a layer of a transaction card according to a third exemplary embodiment of the present invention;

FIG. **18** is a front elevation view thereof;
FIG. **19** is a rear elevation view thereof;
FIG. **20** is an elevation view thereof taken from the left side;
FIG. **21** is an elevation view thereof taken from the right side;
FIG. **22** is a top plan view thereof; and
FIG. **23** is a bottom plan view thereof; and,
FIG. **24** is an enlarged view of a portion of FIG. **20**.
The broken line showing of the layer of the transaction card is for the purpose of illustrating portions of the layer of the transaction card and forms no part of the claimed design.

1 Claim, 12 Drawing Sheets

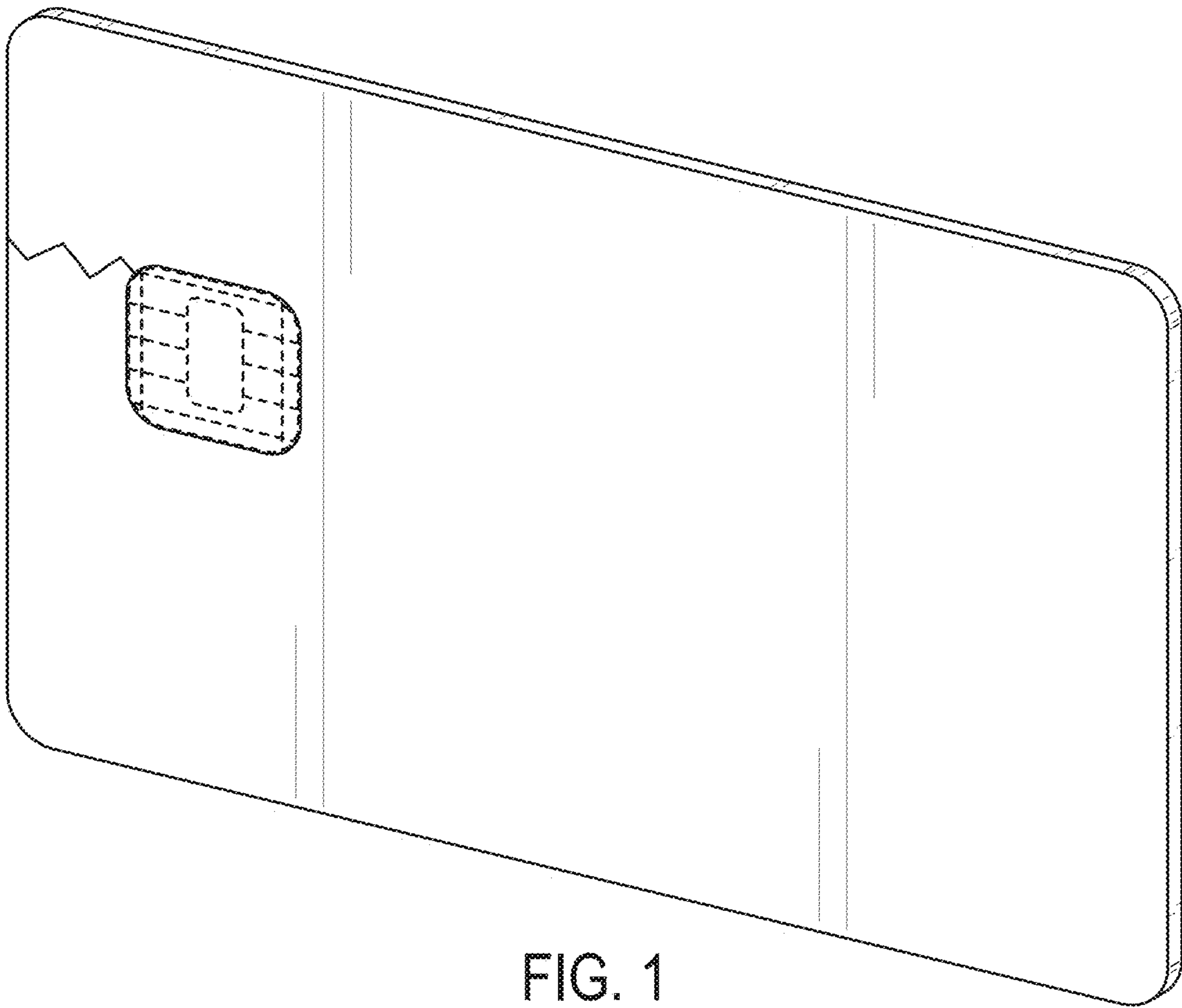

FIG. 1

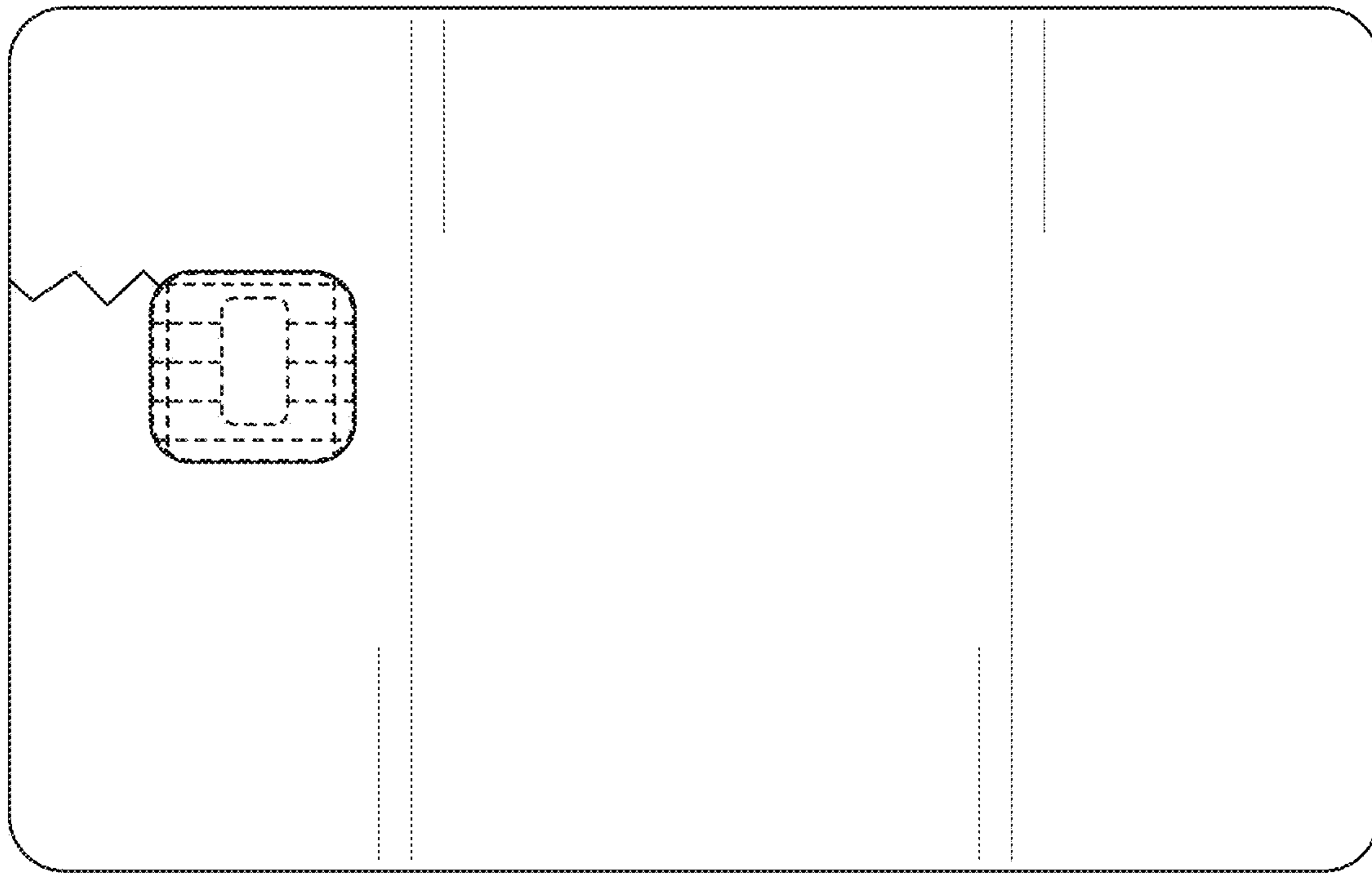

FIG. 2

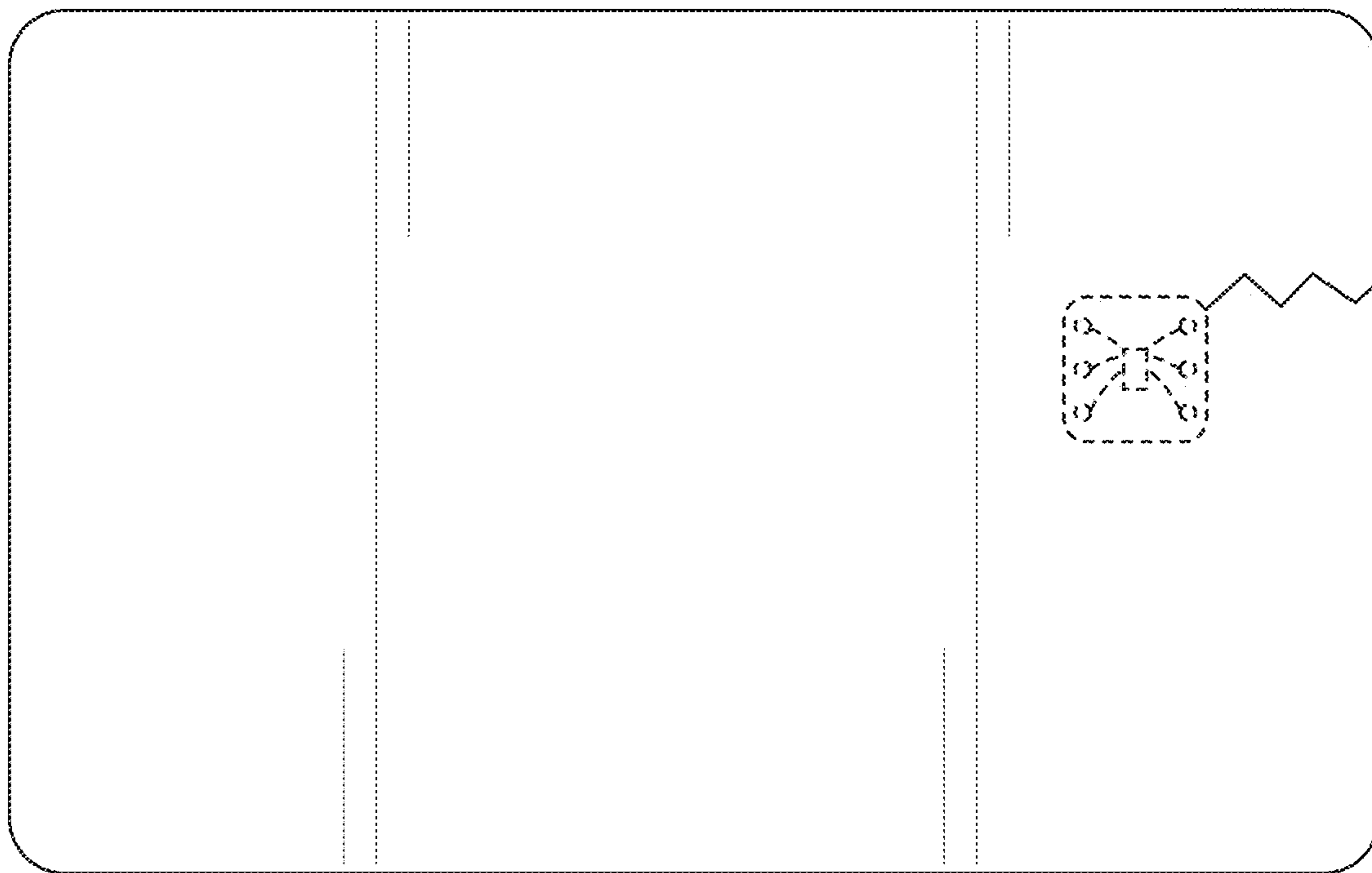

FIG. 3

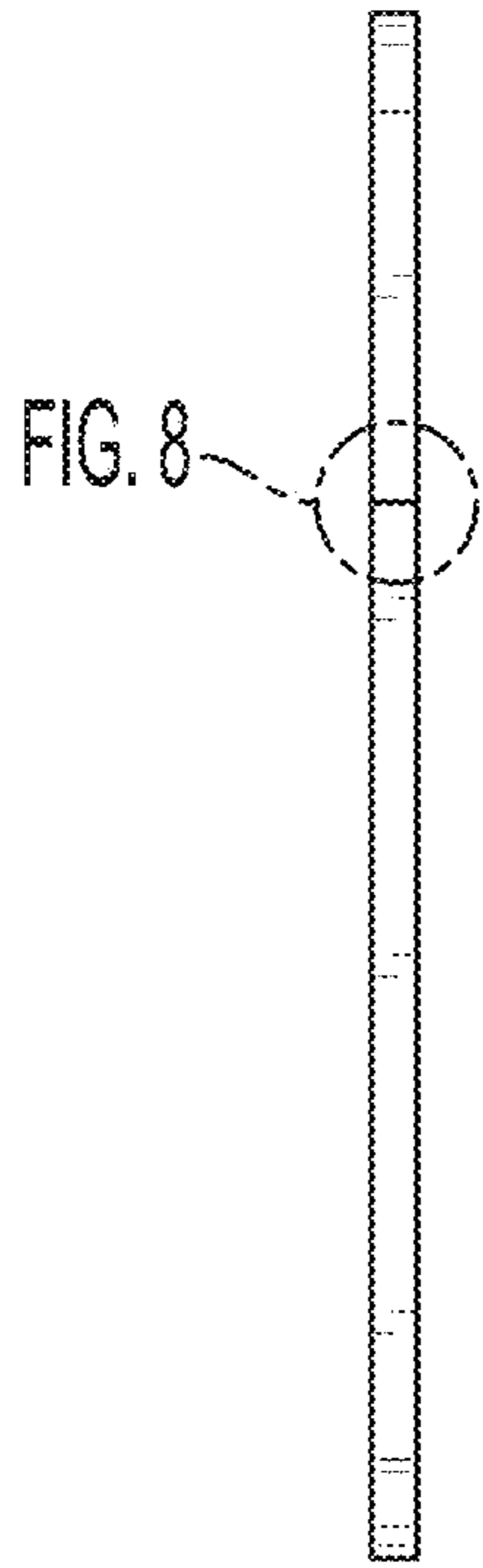

FIG. 4

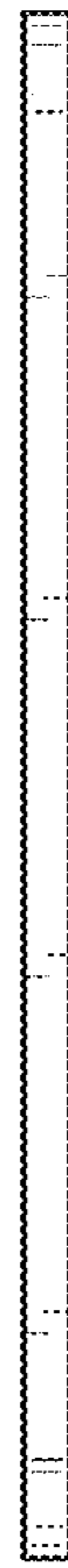

FIG. 5



FIG. 6



FIG. 7

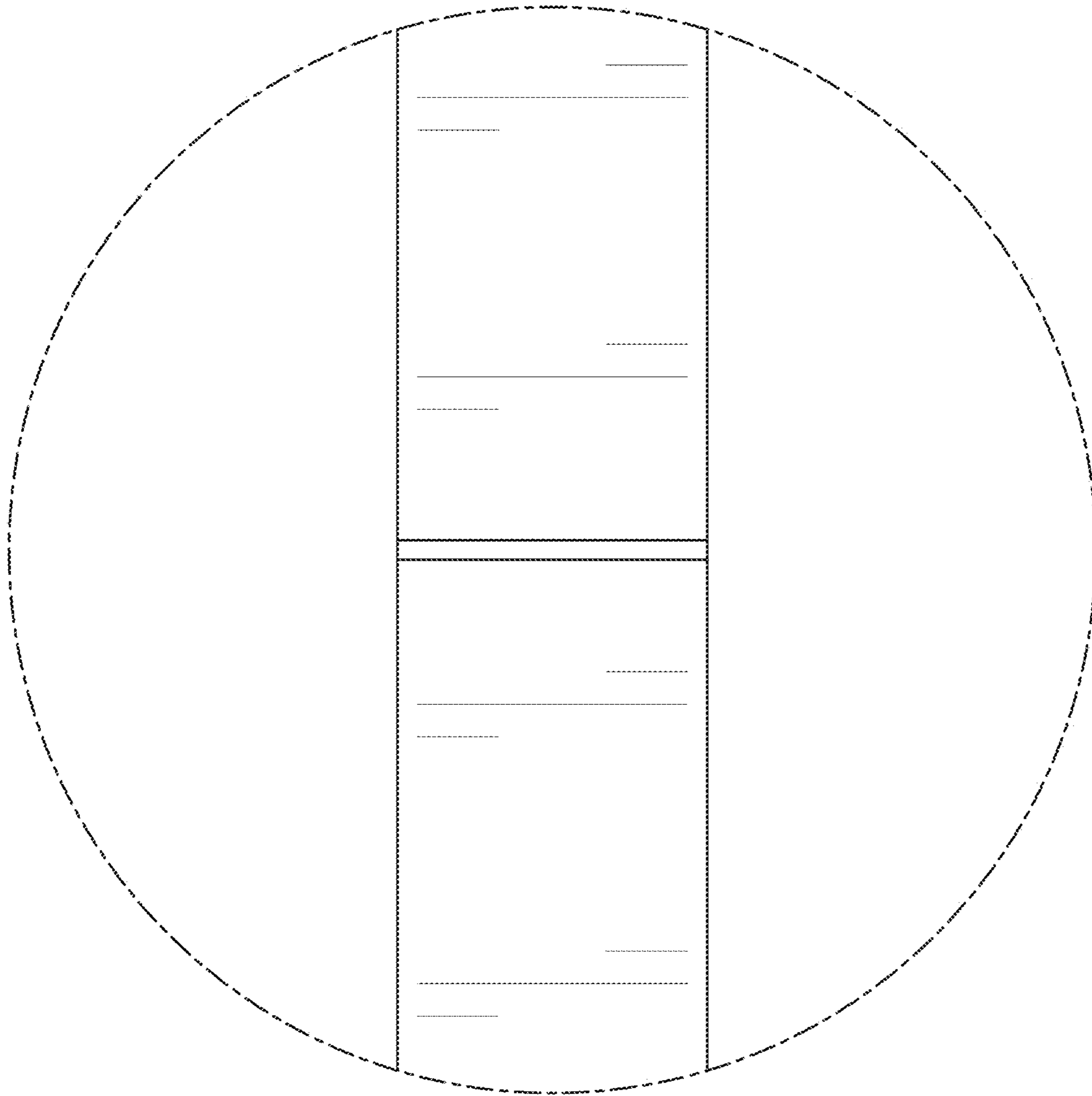

FIG. 8

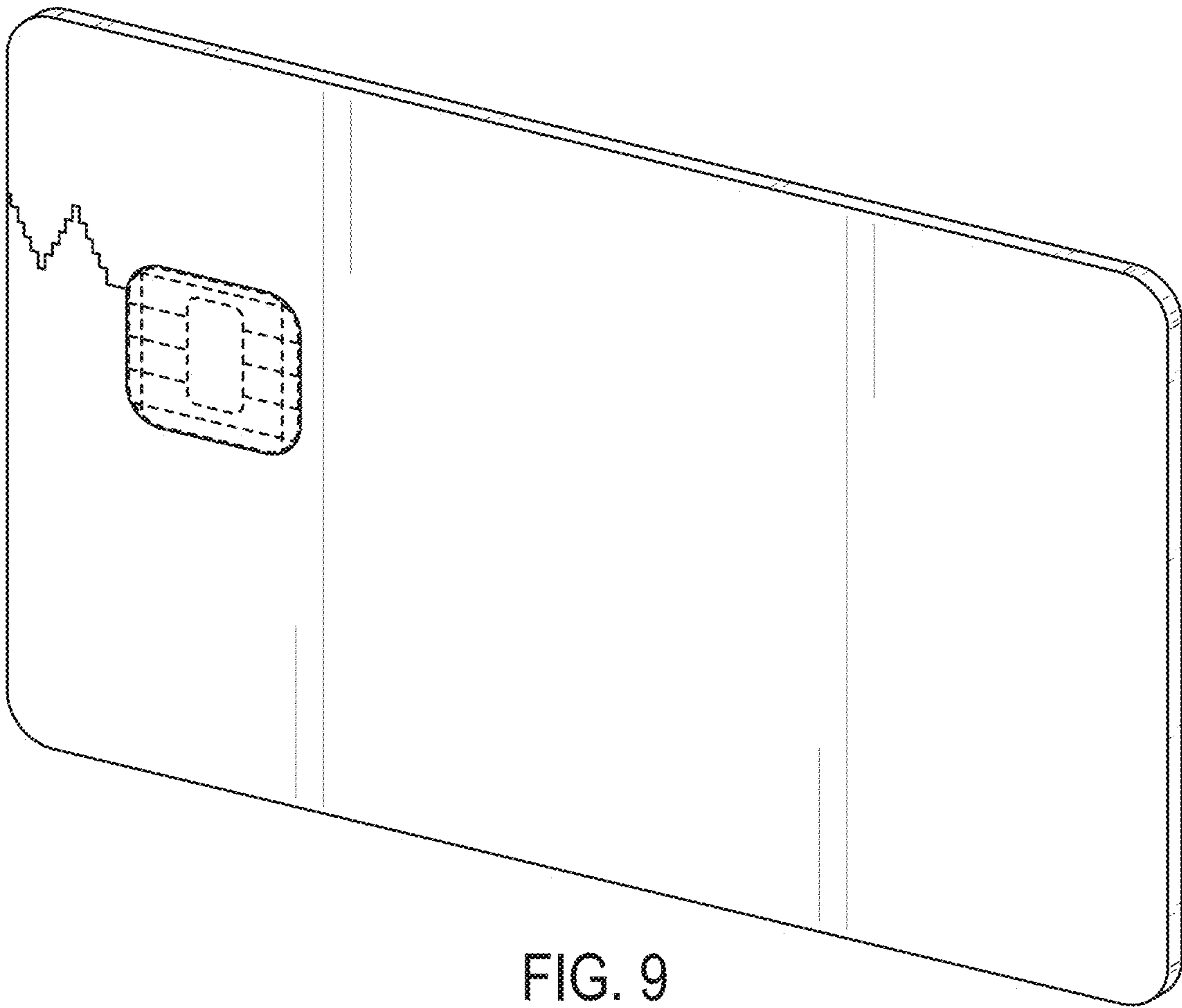

FIG. 9

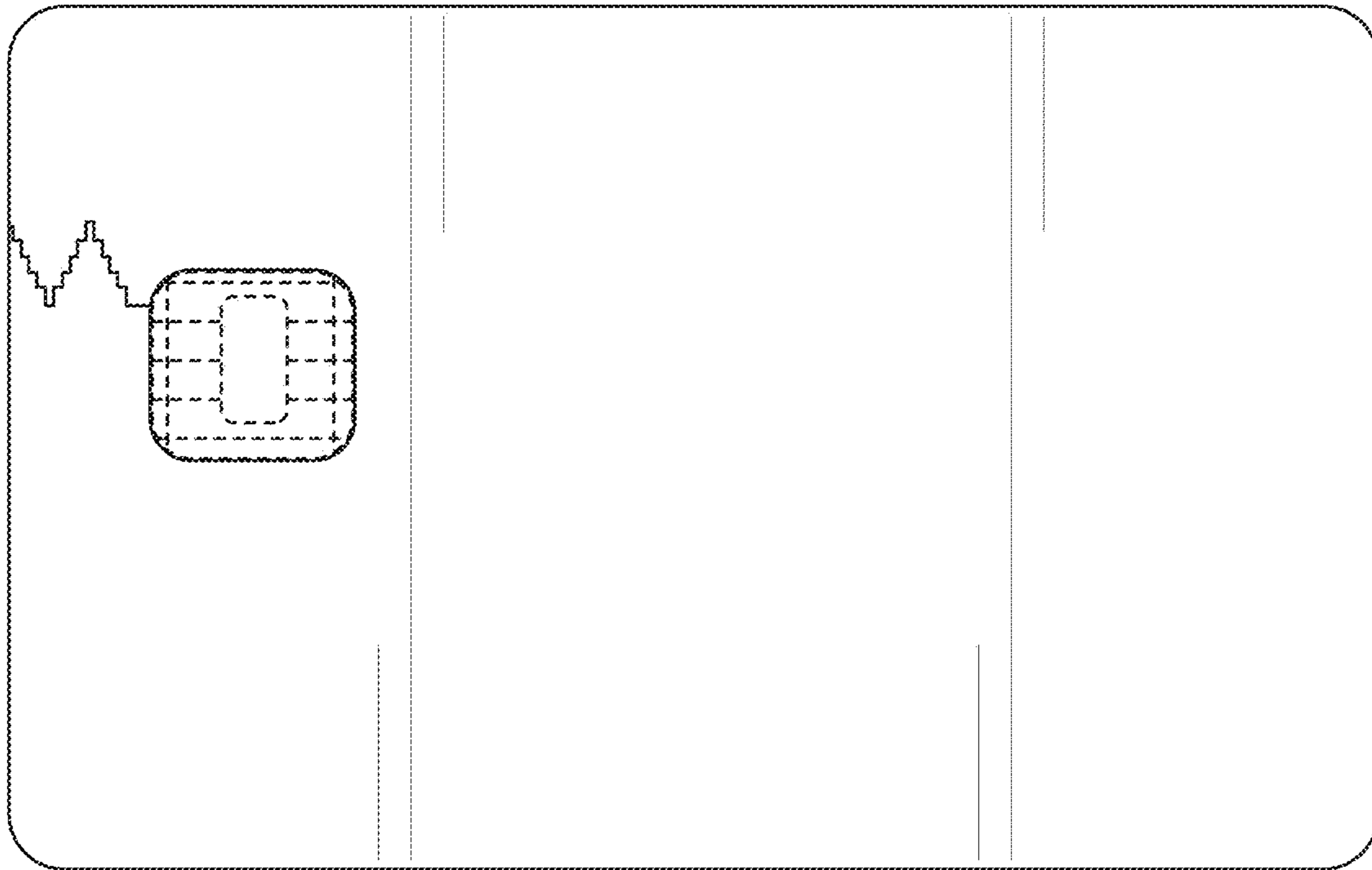

FIG. 10

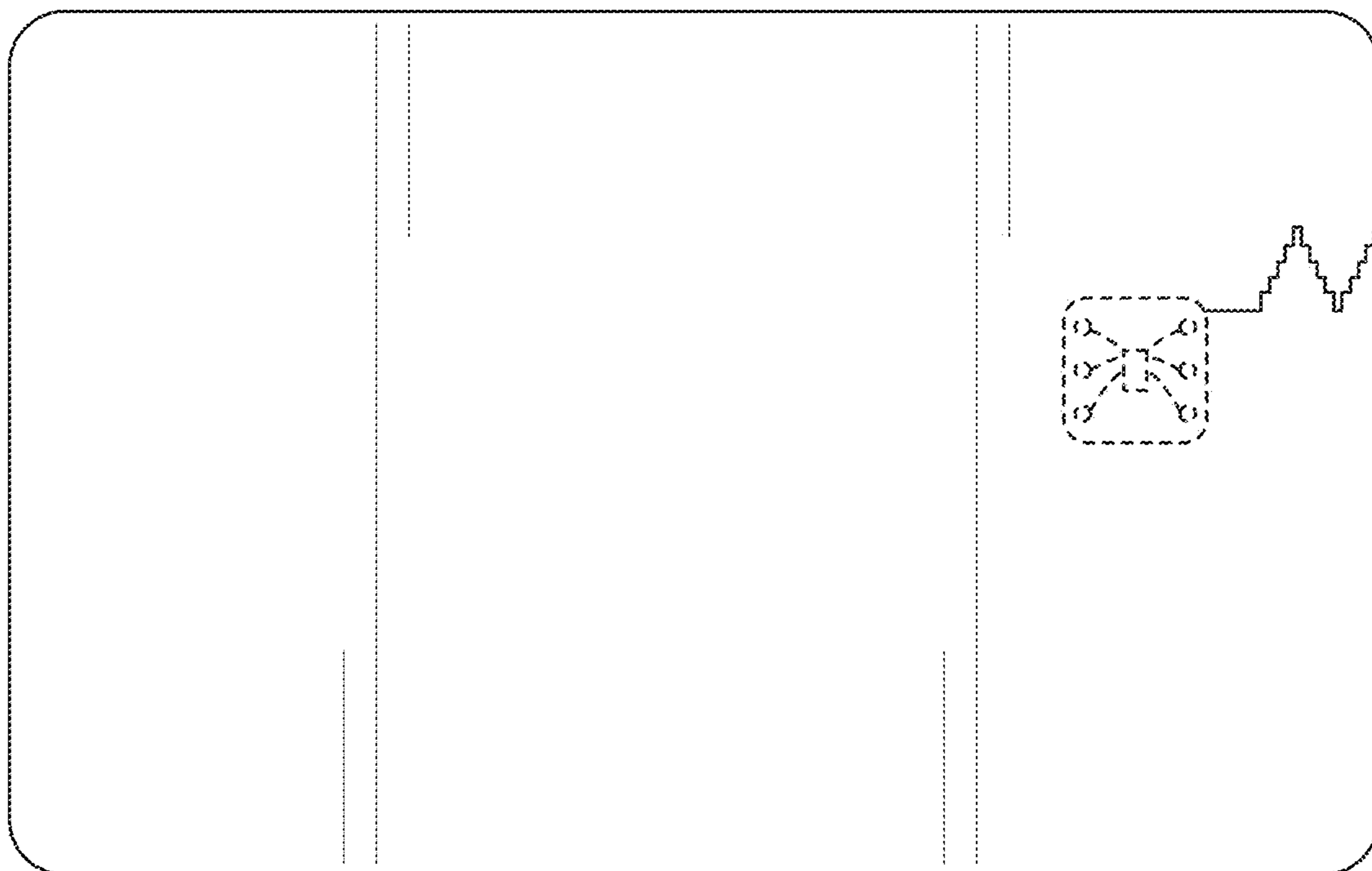

FIG. 11

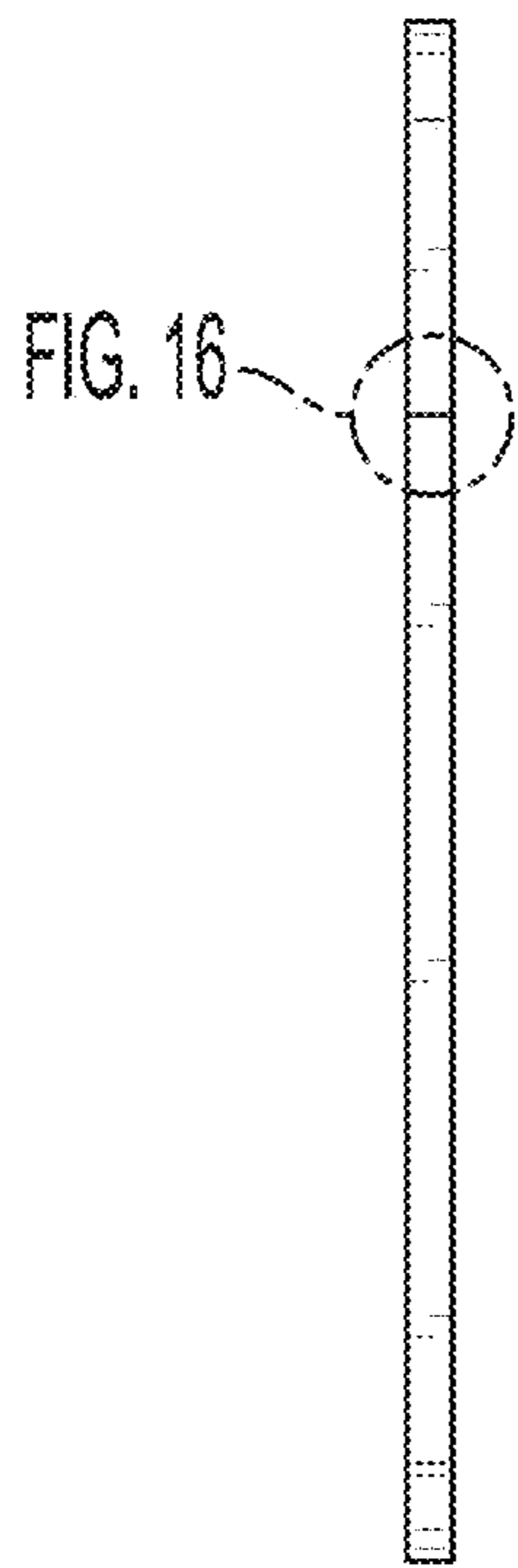

FIG. 12

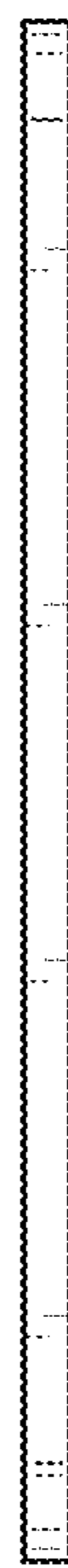

FIG. 13

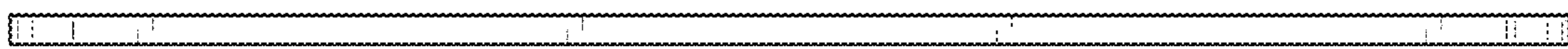

FIG. 14



FIG. 15

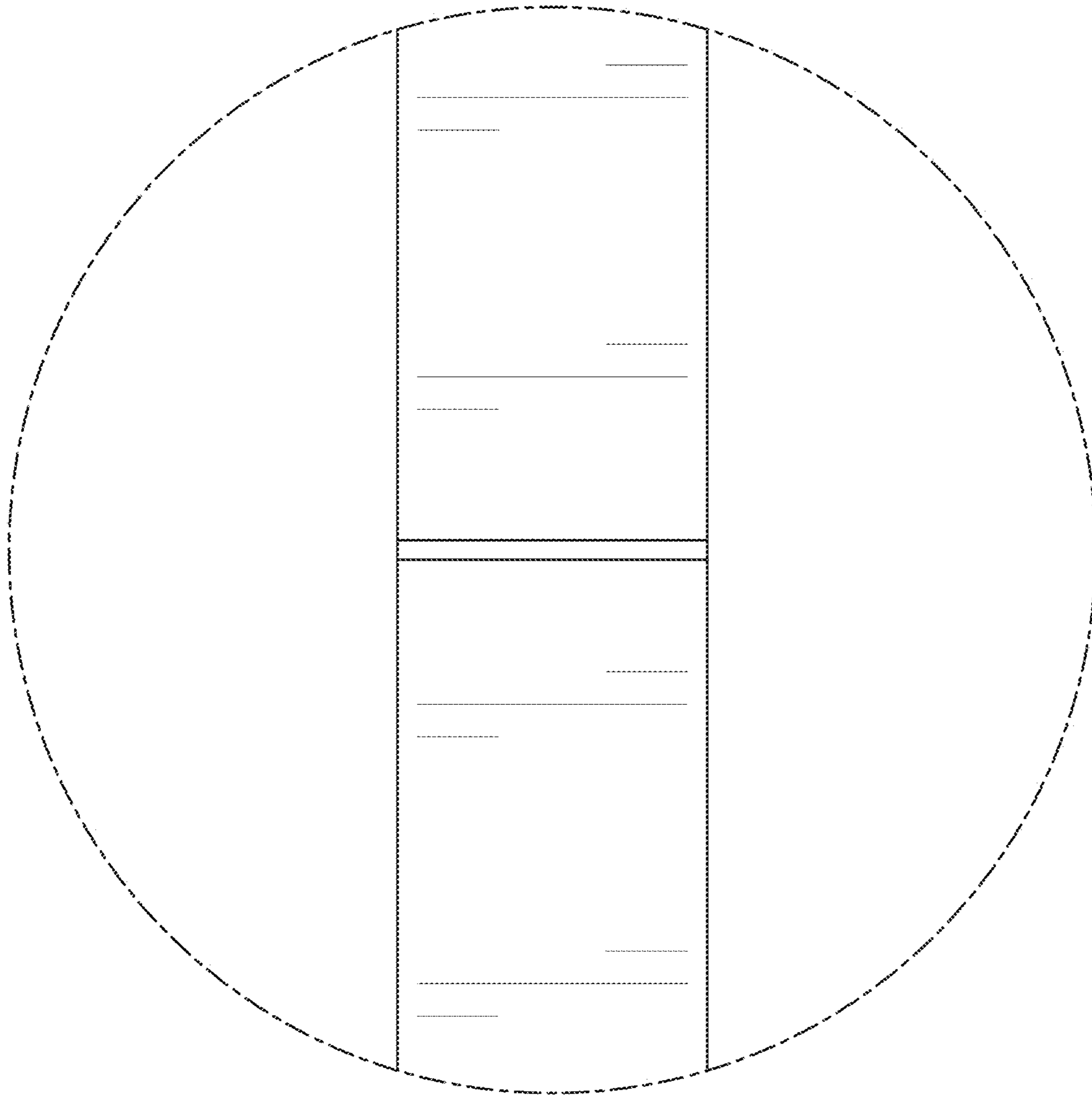

FIG. 16

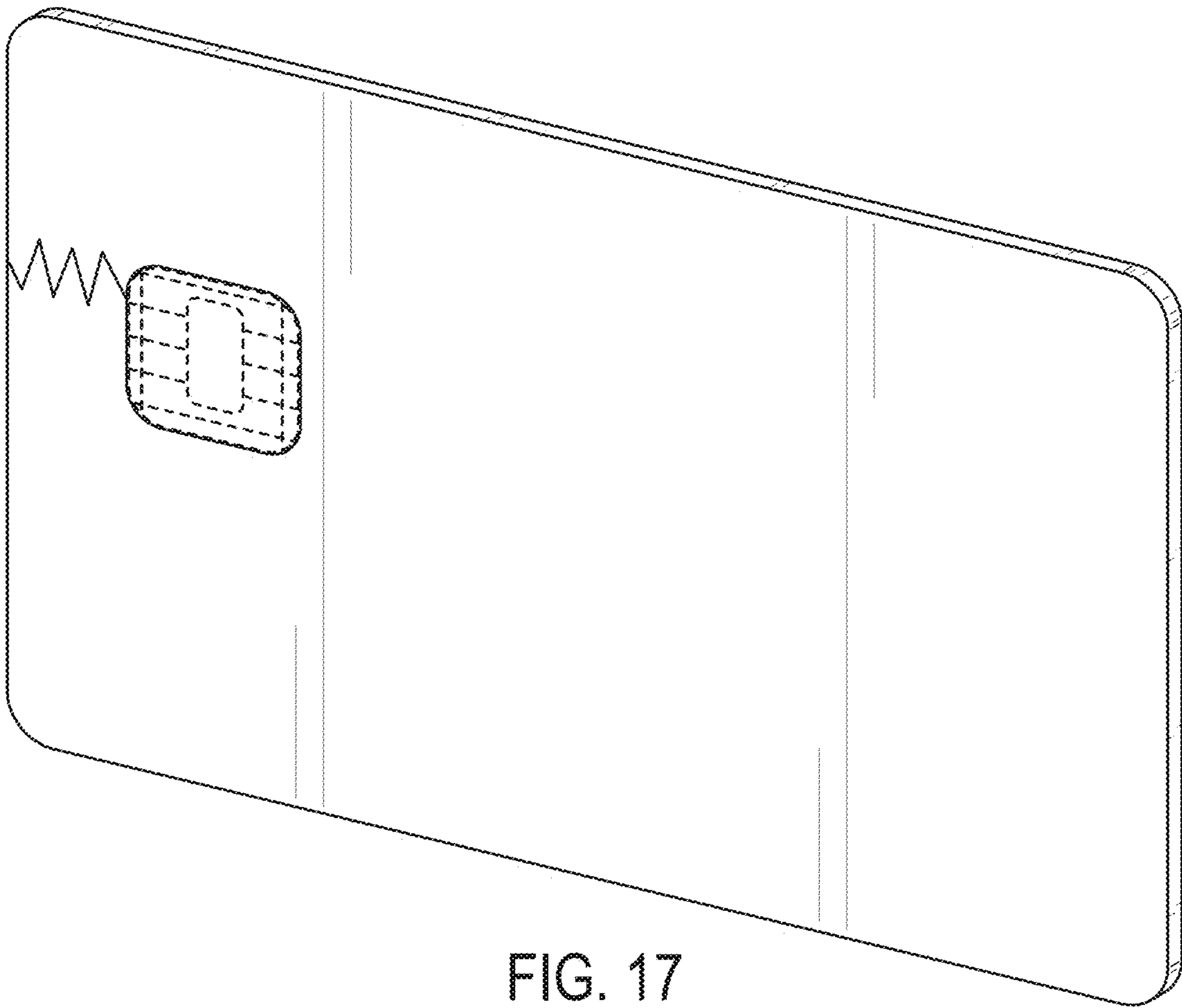

FIG. 17

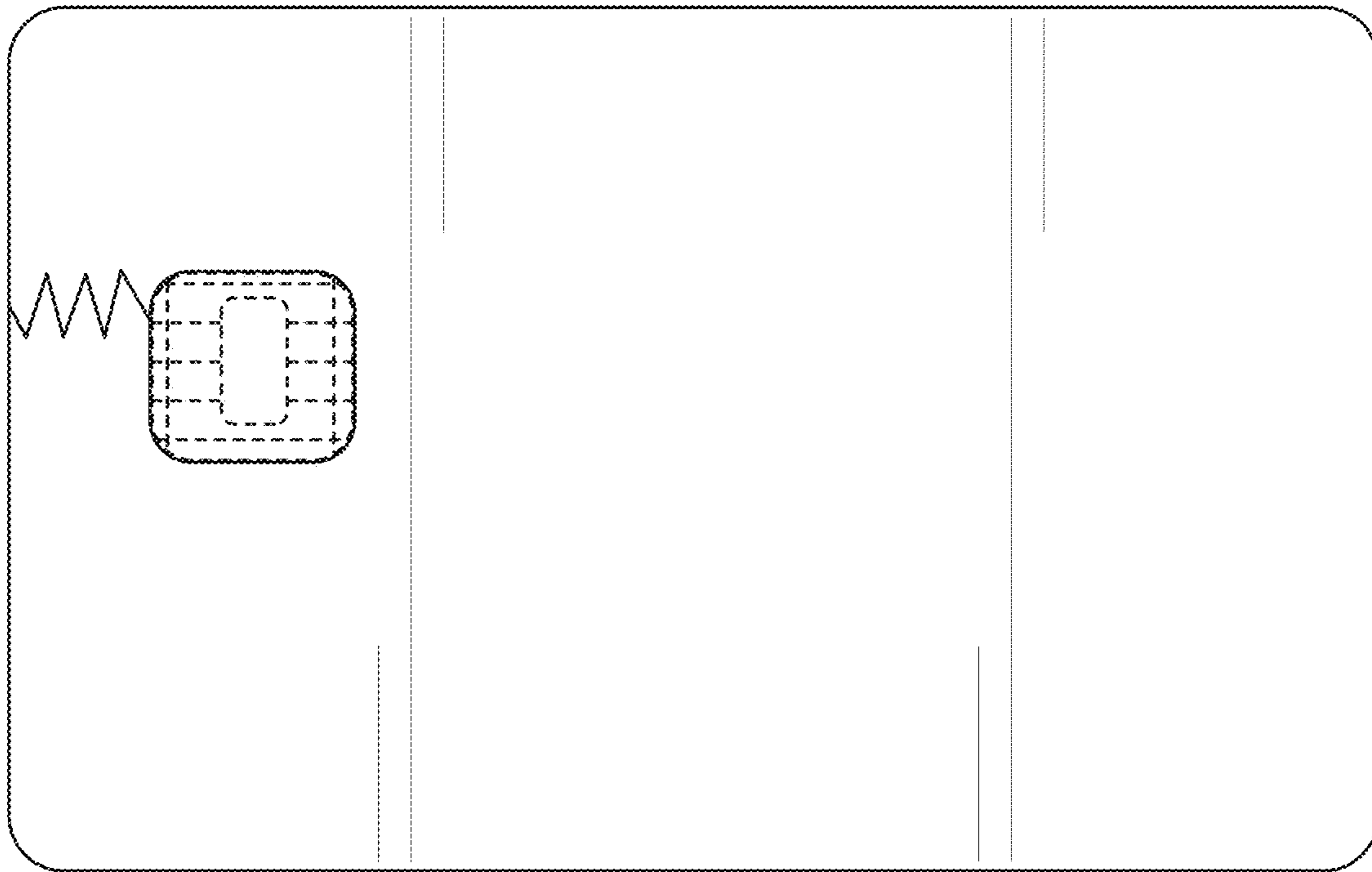

FIG. 18

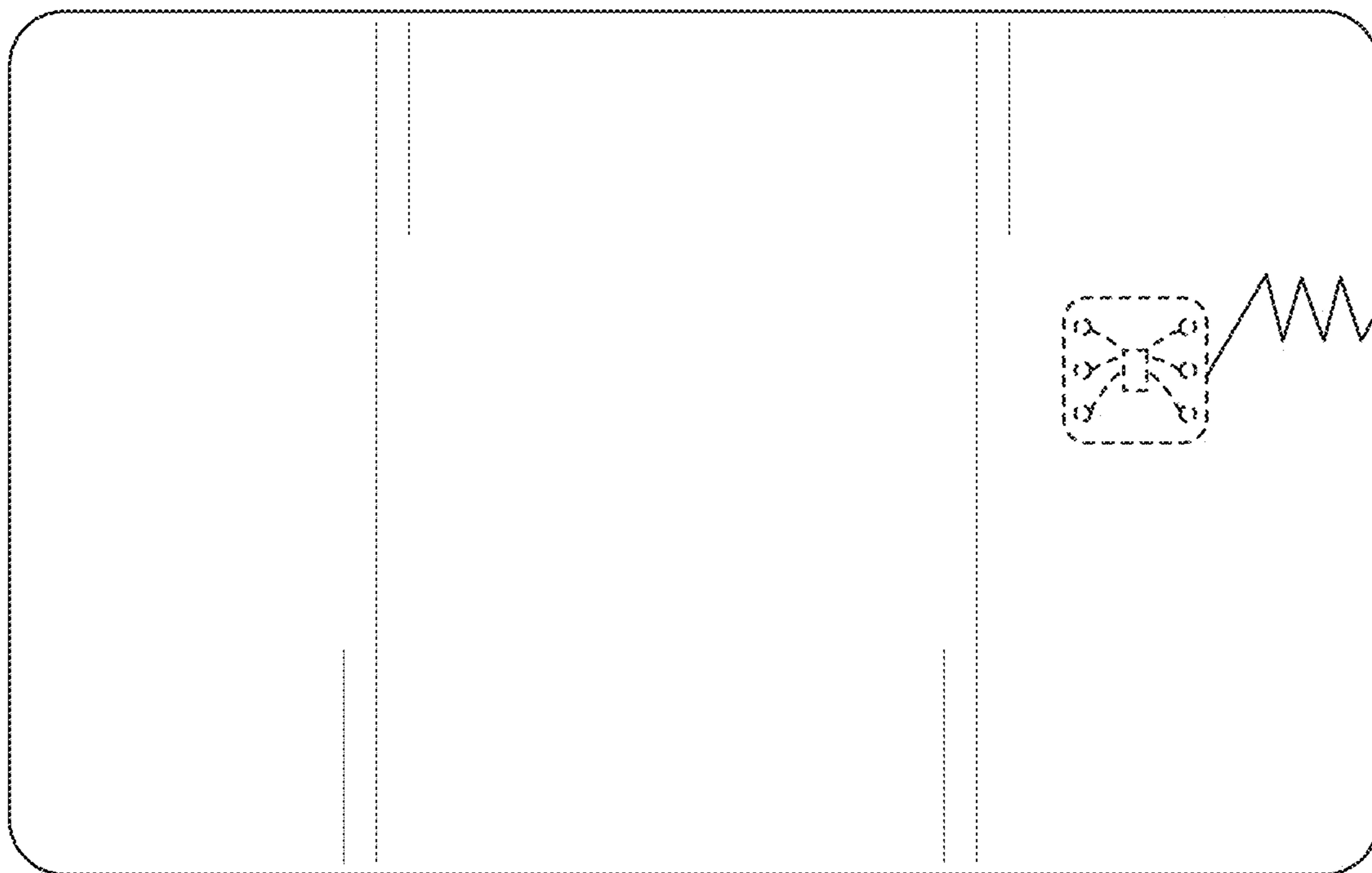

FIG. 19

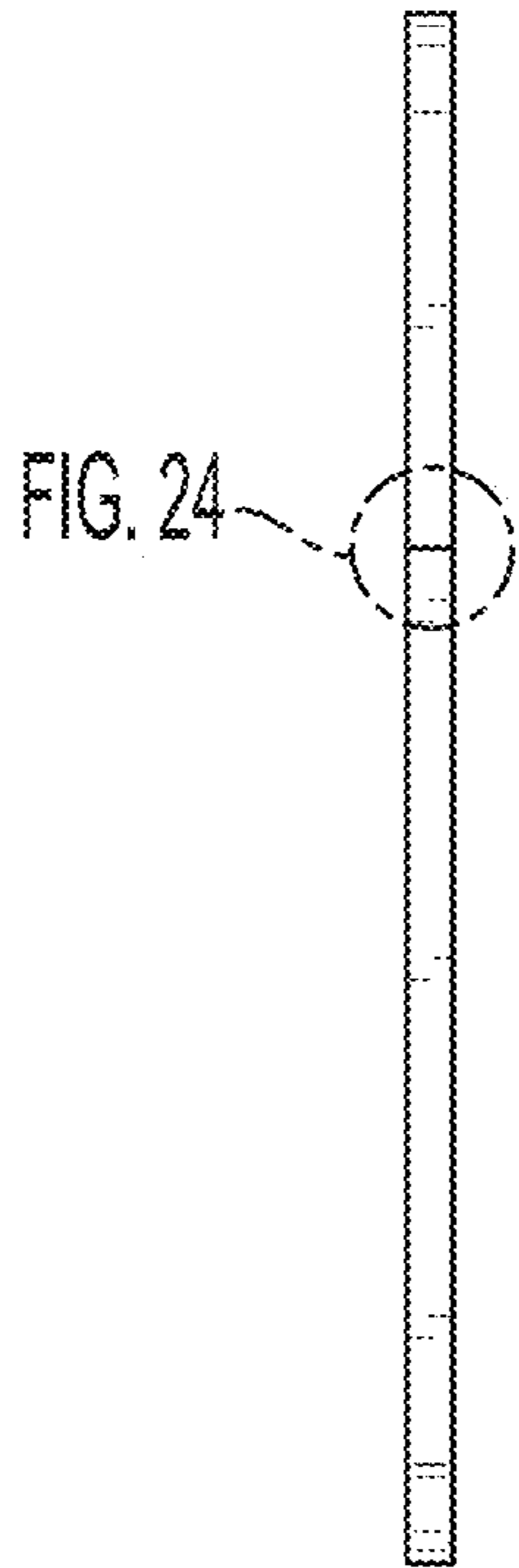

FIG. 20

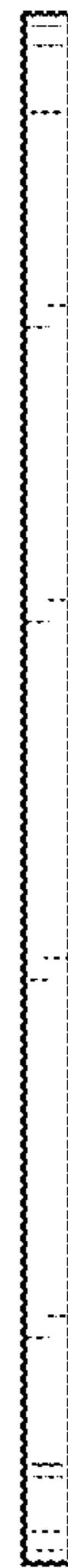

FIG. 21

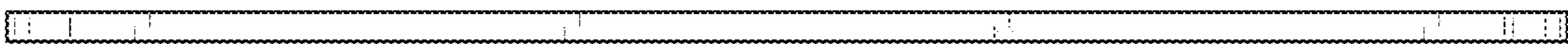

FIG. 22



FIG. 23

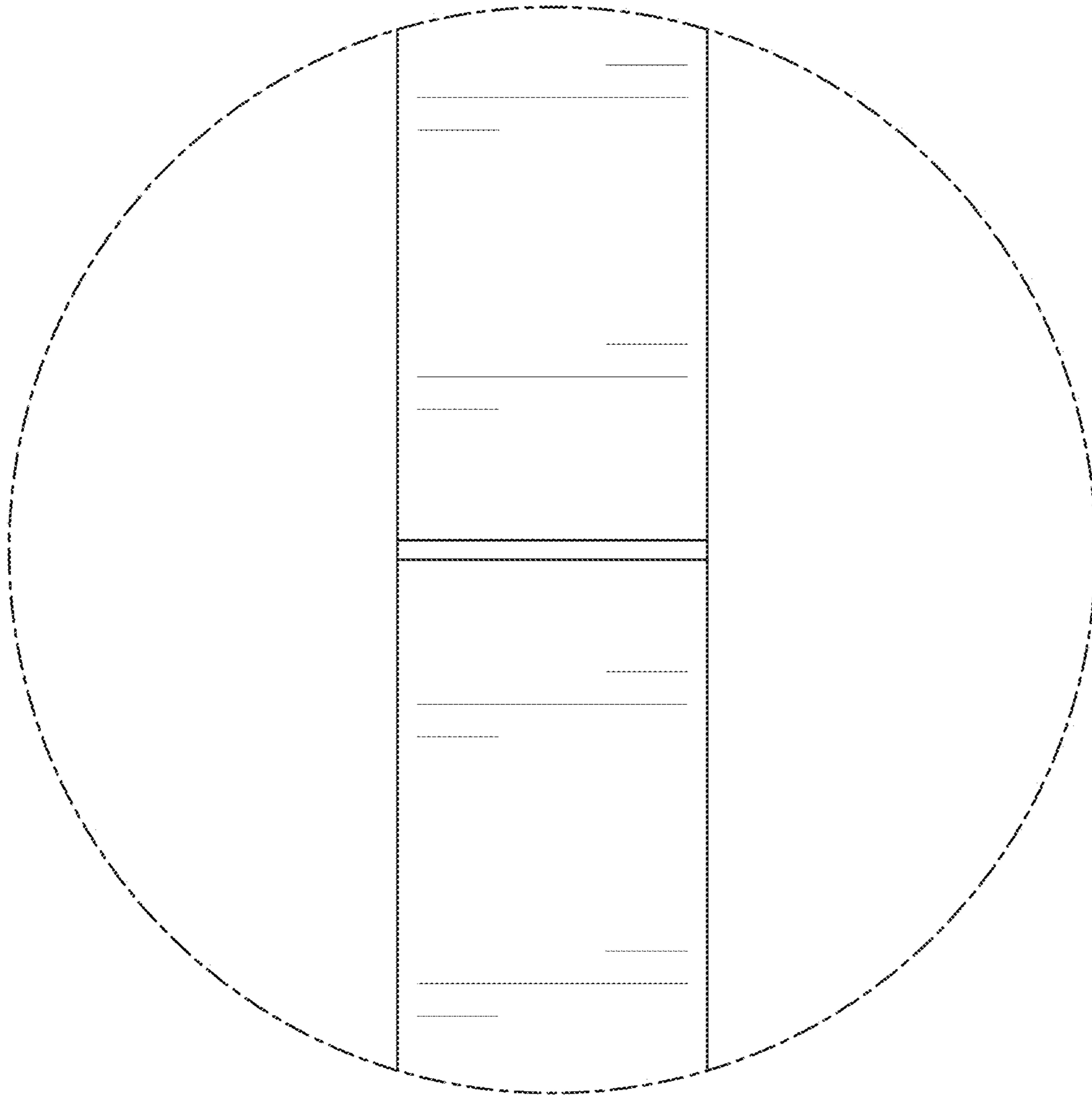

FIG. 24