

US00D944295S

(12) **United States Design Patent** (10) **Patent No.:** **US D944,295 S**
Jewison et al. (45) **Date of Patent:** **** Feb. 22, 2022**

(54) **SHEET METAL STYLING FOR AN EXCAVATOR**

(71) Applicant: **DEERE & COMPANY**, Moline, IL (US)

(72) Inventors: **Jack J. Jewison**, Platteville, WI (US); **Richard Pugh**, Dubuque, IA (US); **Manish M. Kute**, Dubuque, IA (US); **Ryan J. Seffinga**, Mineral Point, WI (US); **Thomas R. Vantiger**, Peosta, IA (US)

(73) Assignee: **Deere & Company**, Moline, IL (US)

(**) Term: **15 Years**

(21) Appl. No.: **29/754,520**

(22) Filed: **Oct. 12, 2020**

(51) **LOC (13) Cl.** **12-09**

(52) **U.S. Cl.**
USPC **D15/25; D15/28**

(58) **Field of Classification Search**
USPC D15/10, 22-26, 28, 30; 180/89.1, 89.12, 180/89.13, 900, 9.1, 9.2, 9.62; 37/379; 414/694, 699, 722-724, 660, 685, 698, 414/719, 743
CPC E02F 3/32; E02F 3/76; E02F 3/40; E02F 3/325; E02F 3/352; E02F 3/384; E02F 3/425; E02F 3/437; E02F 3/627; E02F 3/964; E02F 9/163; E02F 9/0858; E02F 9/0875; E02F 9/2045; E02F 9/006; E02F 9/0808; E02F 9/0833; E02F 9/2004; E02F 9/207; E02F 9/2091; E02F 9/2246; E02F 9/2292; E02F 9/0086; E02F 9/18; F01N 13/001; F01N 2590/08

See application file for complete search history.

(56) **References Cited**

U.S. PATENT DOCUMENTS

D406,152 S * 2/1999 Miyaoka D15/25
D677,703 S * 3/2013 Hiraoka D15/25

D678,354 S * 3/2013 Hiraoka D15/25
D717,346 S * 11/2014 Ishii D15/28
D728,638 S * 5/2015 Payne D15/31
D749,150 S * 2/2016 Payne D15/31
D754,214 S * 4/2016 Payne D15/31
D773,536 S * 12/2016 Fiser D15/28
D774,105 S * 12/2016 Jilbert D15/28
D797,814 S * 9/2017 Hashimoto D15/28
D814,528 S * 4/2018 Hallgren D15/28
D814,529 S * 4/2018 Hallgren D15/28
D819,708 S * 6/2018 Ulmefors D15/31
D831,079 S * 10/2018 Ulmefors D15/31
D875,143 S * 2/2020 Hagura D15/24
D896,284 S * 9/2020 Phadatare D15/22
D896,285 S * 9/2020 Phadatare D15/22
D901,554 S * 11/2020 Sonje D15/31
D908,739 S * 1/2021 Zong D15/25
D915,470 S * 4/2021 Ninomiya D15/25
D927,559 S * 8/2021 Shinde D15/24

* cited by examiner

Primary Examiner — Mark A Goodwin

(57) **CLAIM**

The ornamental design for a sheet metal styling for an excavator, as shown and described.

DESCRIPTION

FIG. 1 is a perspective view of a sheet metal styling for an excavator showing our new design.
FIG. 2 is a left side view thereof.
FIG. 3 is a right side view thereof.
FIG. 4 is a front view thereof.
FIG. 5 is a rear view thereof.
FIG. 6 is a top view thereof; and,
FIG. 7 is a bottom view thereof.
The broken line representations of environmental structure in FIGS. 1-7 is for illustrative purposes only and forms no part of the claimed design.

1 Claim, 5 Drawing Sheets

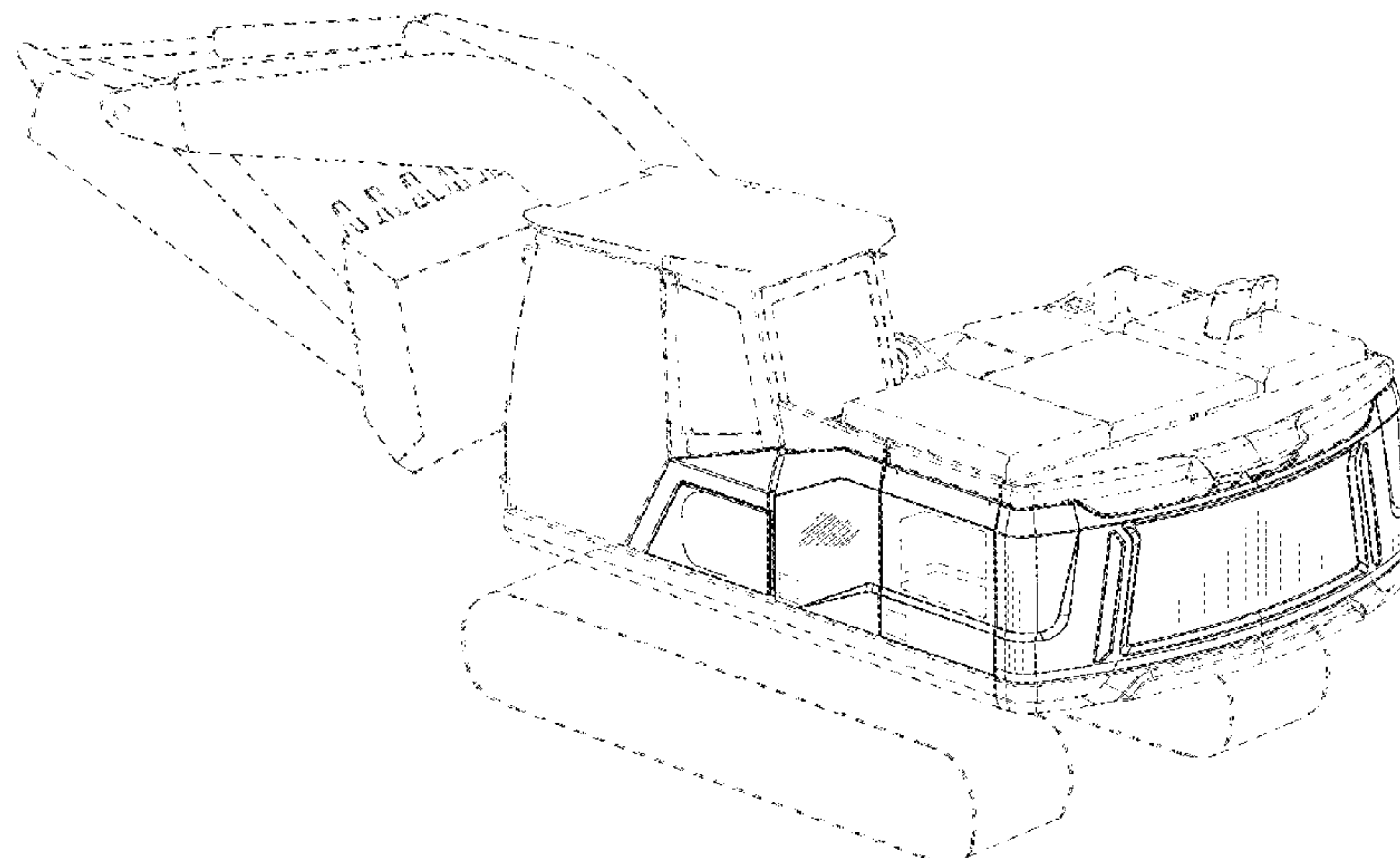

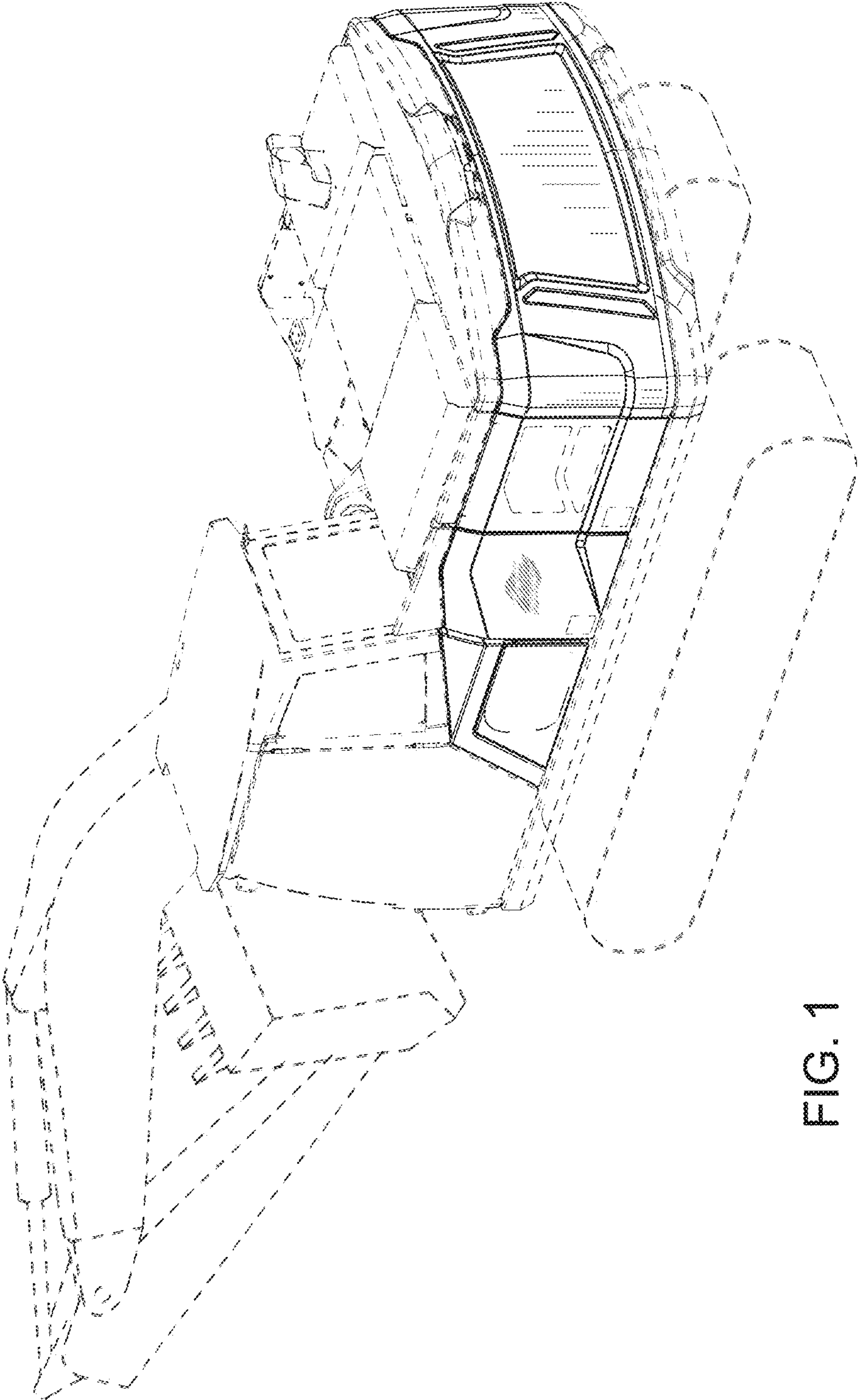

FIG. 1

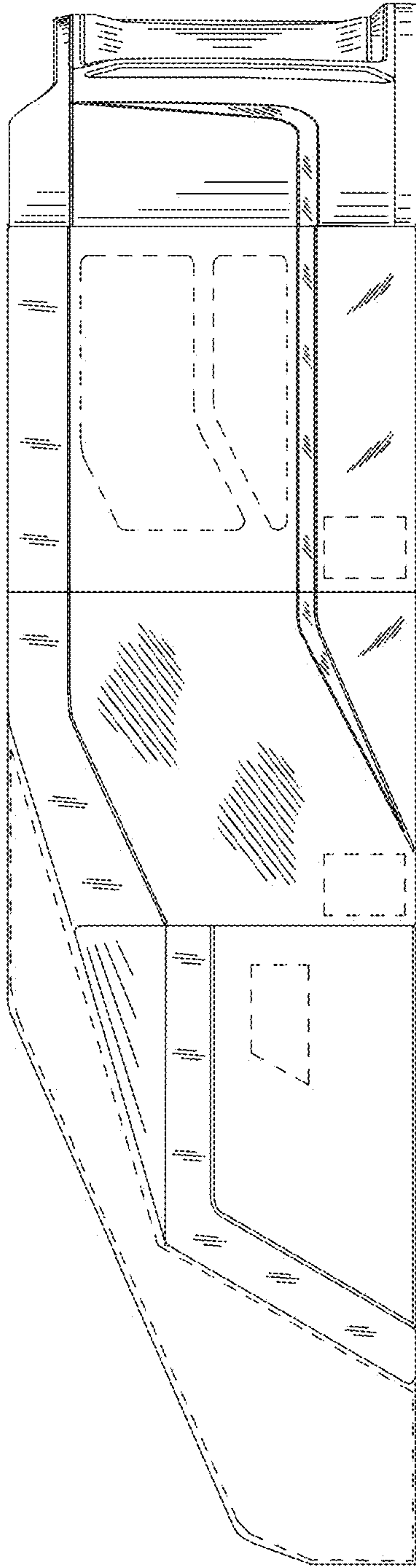

FIG. 2

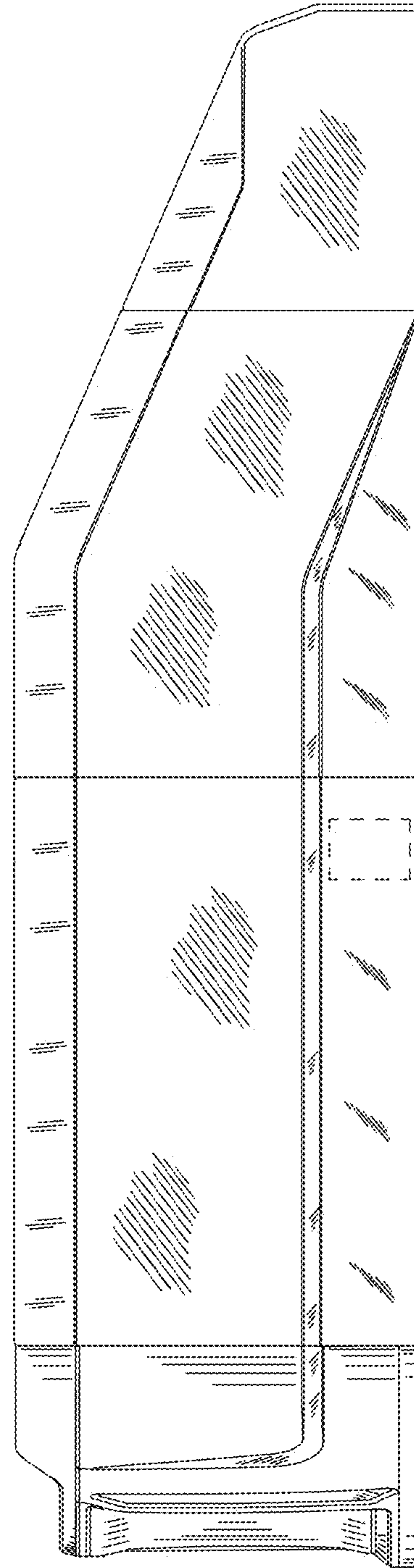

FIG. 3

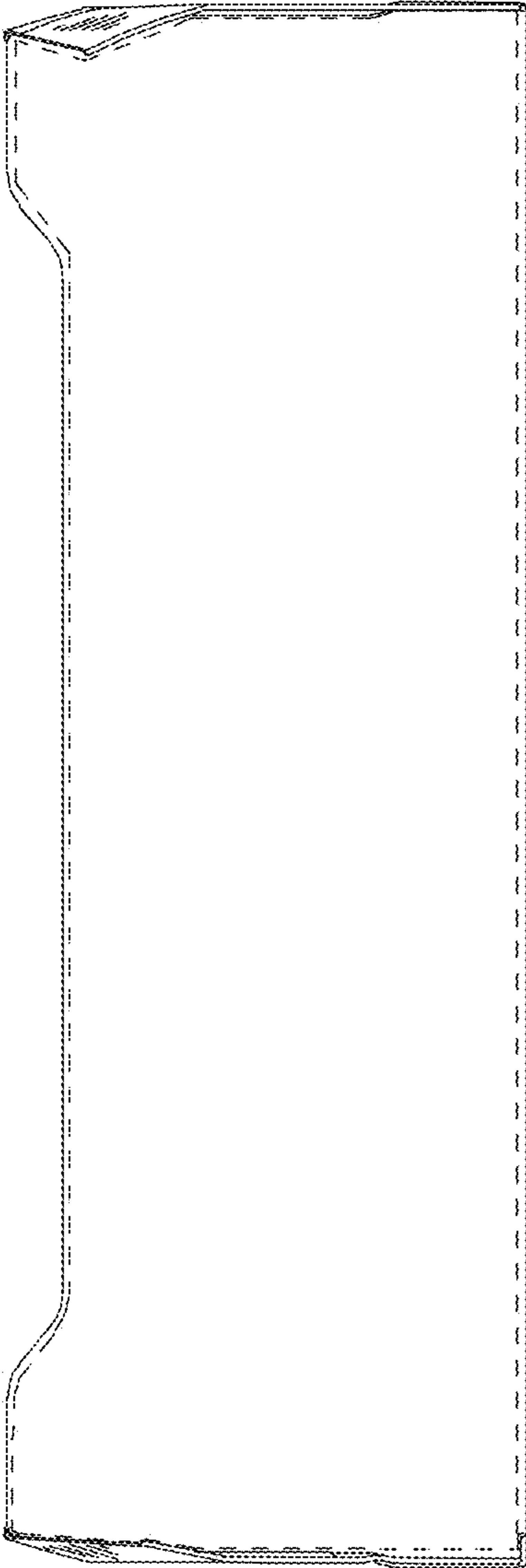

FIG. 4

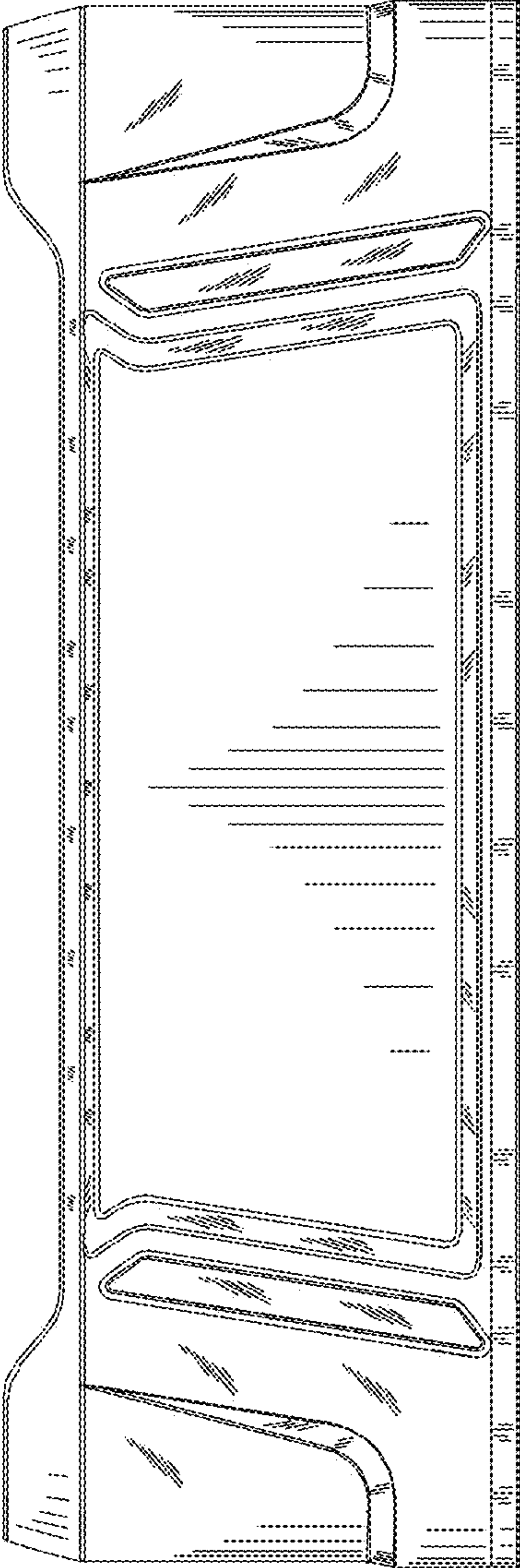

FIG. 5

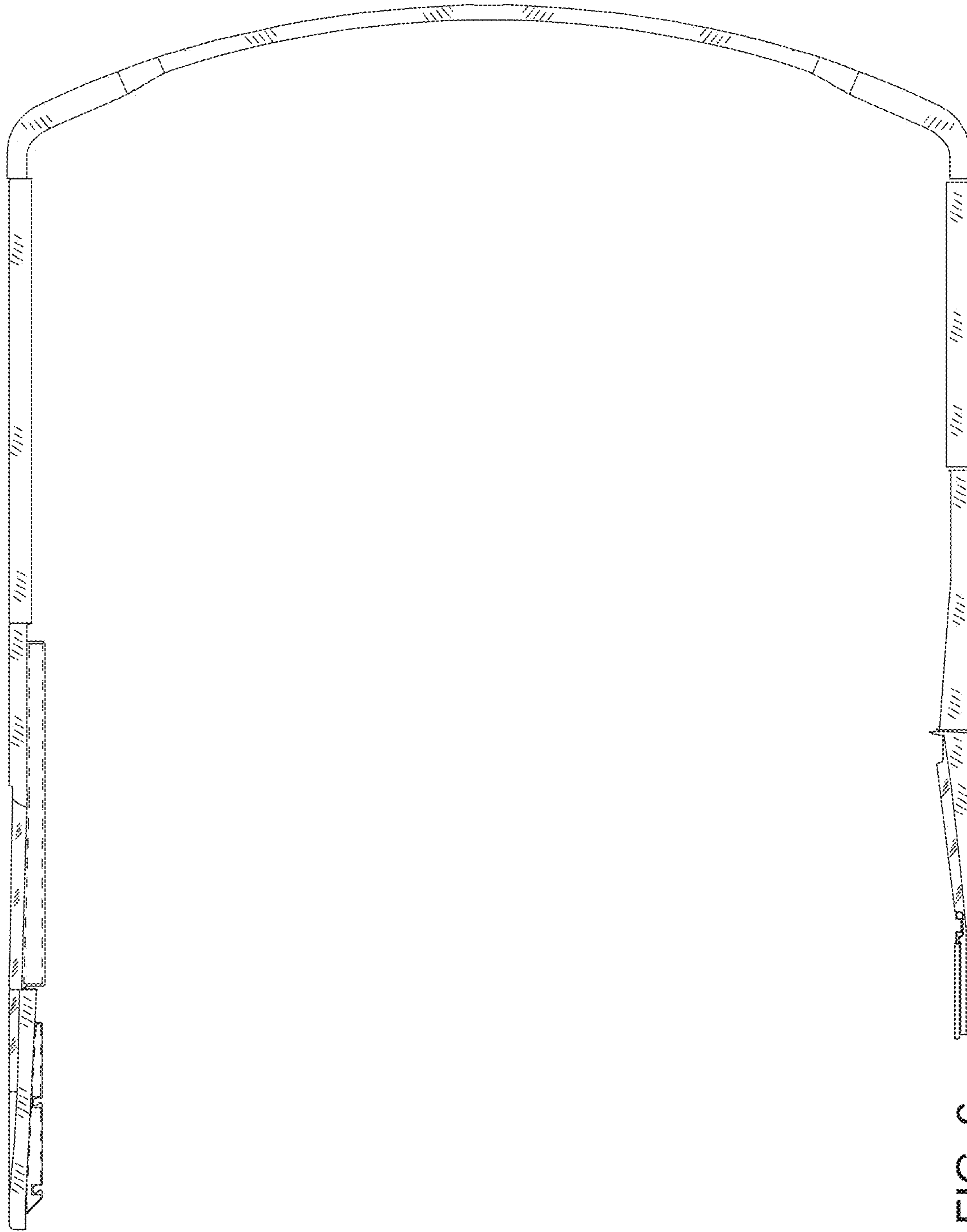

FIG. 6

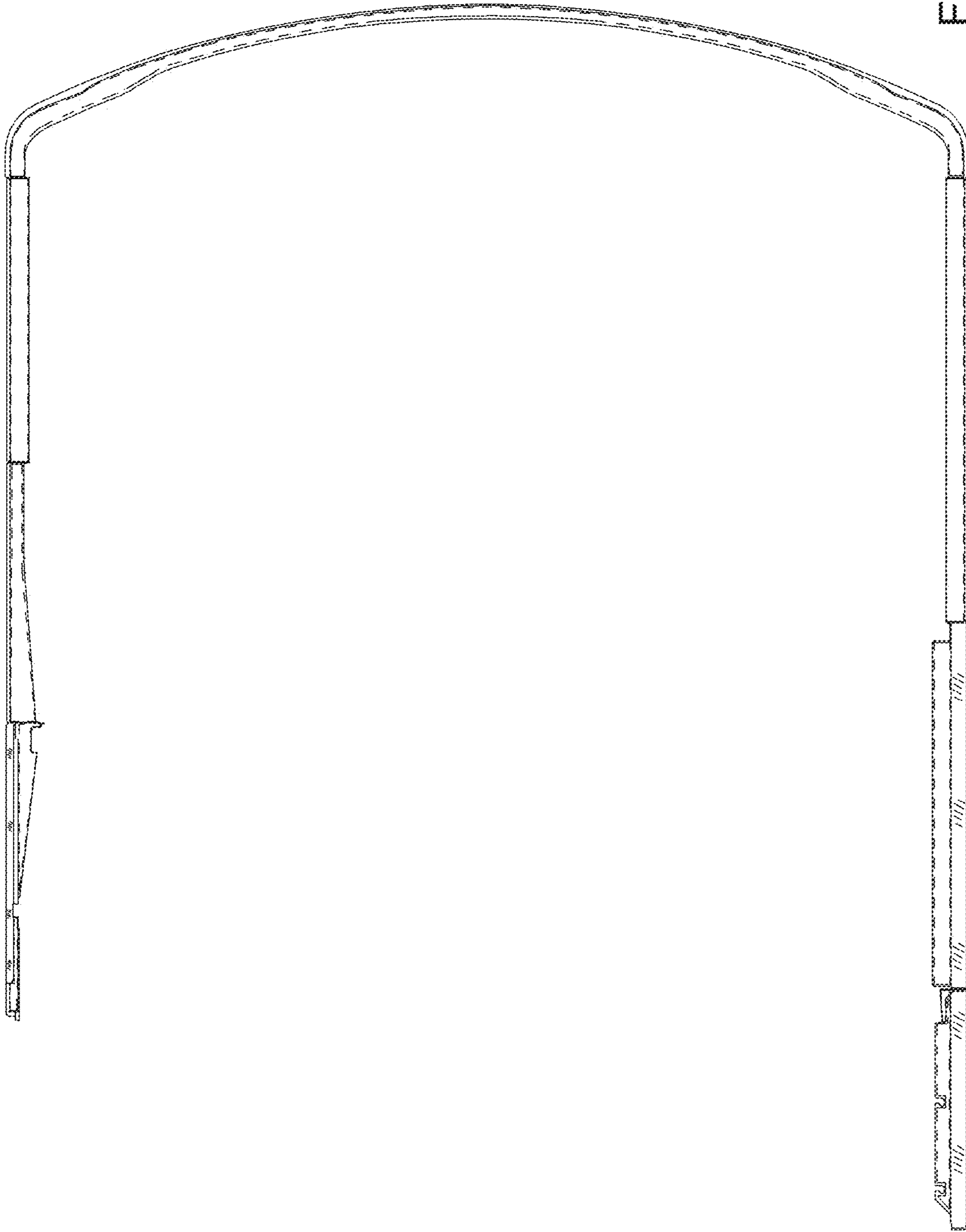

FIG. 7