



US00D944162S

(12) **United States Design Patent** (10) **Patent No.:** **US D944,162 S**
Kim et al. (45) **Date of Patent:** **** *Feb. 22, 2022**

(54) **VEHICLE MIRROR**

(71) Applicant: **Ford Global Technologies, LLC**,
Dearborn, MI (US)
(72) Inventors: **Soohyoung Kim**, Northville, MI (US);
Damon G. Depeyster, Northville, MI
(US); **Gordon M. Platto**, Troy, MI
(US)
(73) Assignee: **Ford Global Technologies, LLC**,
Dearborn, MI (US)

(*) Notice: This patent is subject to a terminal disclaimer.

(**) Term: **15 Years**

(21) Appl. No.: **29/736,747**

(22) Filed: **Jun. 2, 2020**

Related U.S. Application Data

(62) Division of application No. 29/650,662, filed on Jun. 8, 2018, now Pat. No. Des. 886,015.

(51) **LOC (13) Cl.** **12-16**

(52) **U.S. Cl.**
USPC **D12/187**

(58) **Field of Classification Search**
USPC D12/114, 187-189, 191, 400, 404, 181;
D6/300, 309; 359/843, 844, 881, 877,
359/604, 868, 838, 839, 841, 514, 871;
248/466, 474

CPC B60R 1/076; B60R 1/074; B60R 1/078;
B60R 1/08; B60R 1/006; B60R 1/02;
B60R 1/06; B60R 1/0612; B60R 1/062;
B60R 1/064; G02B 7/182; G02B 7/18

See application file for complete search history.

(56) **References Cited**

U.S. PATENT DOCUMENTS

D792,824 S *	7/2017	Bucher	D12/187
D837,705 S *	1/2019	Bucher	D12/187
D865,598 S *	11/2019	Grand	D12/187
D886,015 S *	6/2020	Kim	D12/187
D891,339 S *	7/2020	Tanghe	D12/187
D904,260 S *	12/2020	Piaskowski	D12/187
D908,566 S *	1/2021	Zhao	D12/187
D913,881 S *	3/2021	Hilliard	D12/187
D915,961 S *	4/2021	Woodhouse	D12/187

* cited by examiner

Primary Examiner — Abraham Bahta

(57) **CLAIM**

The ornamental design for a vehicle mirror, as shown and described.

DESCRIPTION

FIG. 1 is a front elevational view of a vehicle mirror, showing our new design;
FIG. 2 is a rear elevation view thereof;
FIG. 3 is a left side elevational view thereof;
FIG. 4 is a right side elevational view thereof;
FIG. 5 is a top plan view thereof;
FIG. 6 is a bottom plan view thereof;
FIG. 7 is a top, front, and left side perspective view thereof;
and,
FIG. 8 is a bottom, front, and left side perspective view thereof.

1 Claim, 8 Drawing Sheets

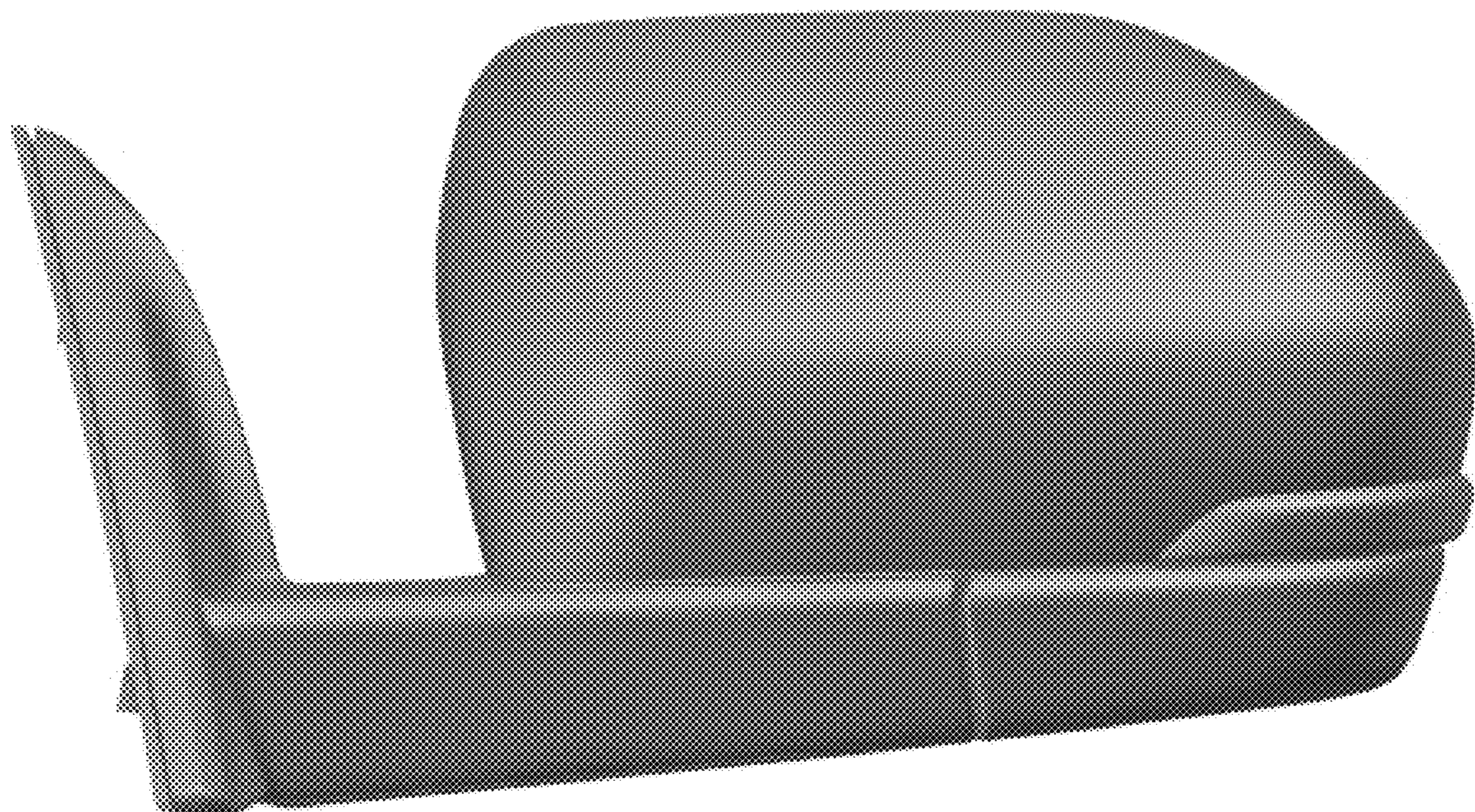

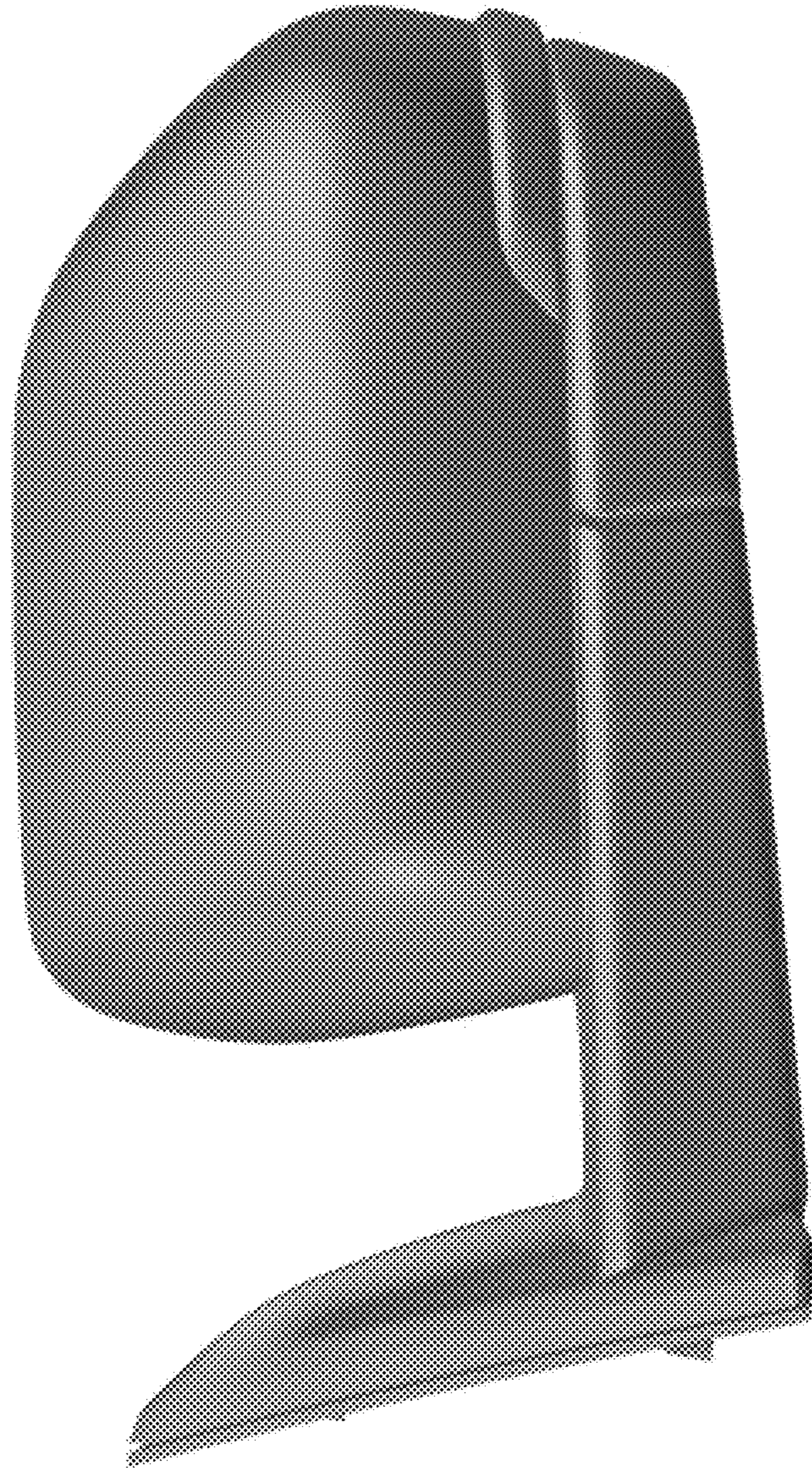

Fig. 1

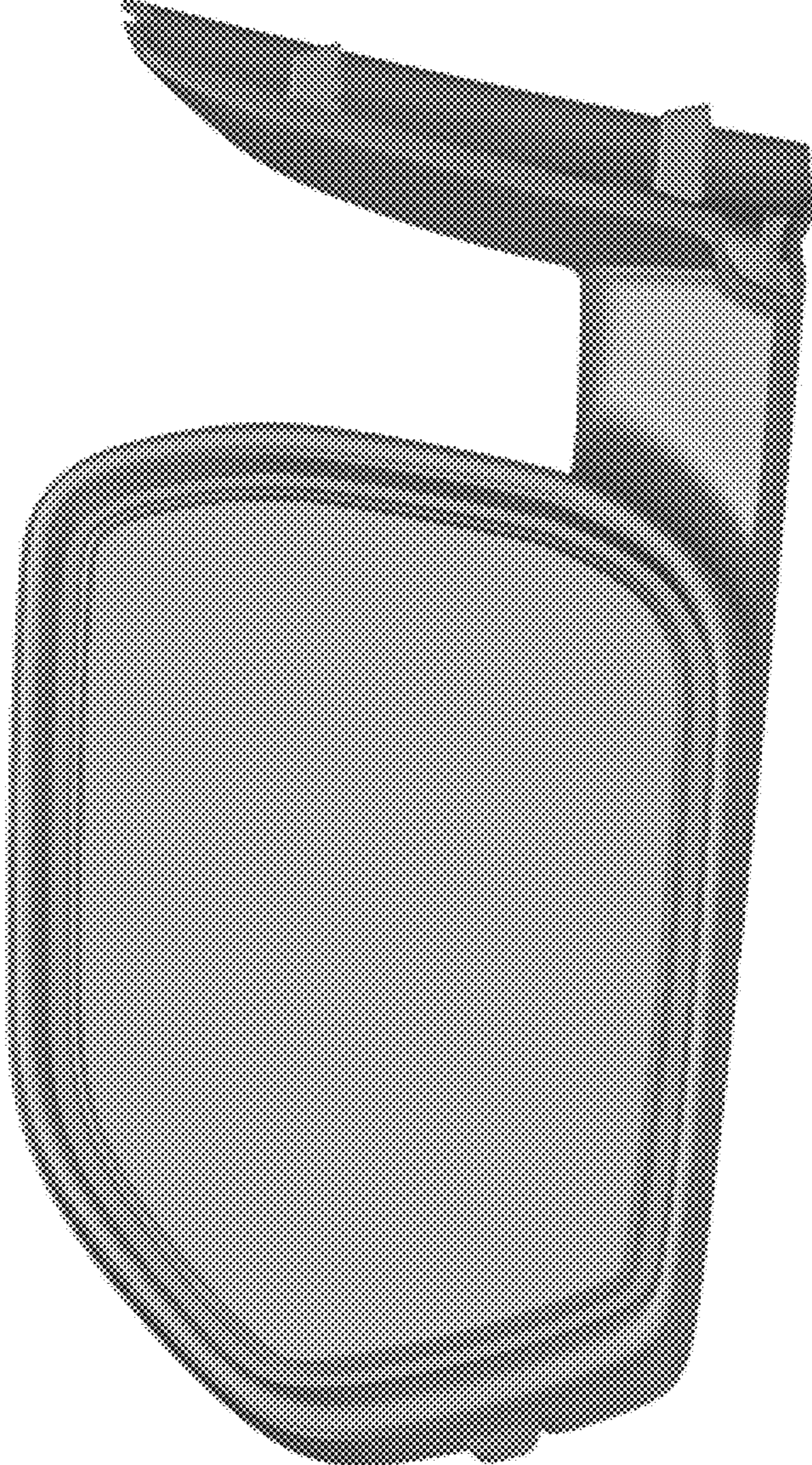

Fig. 2

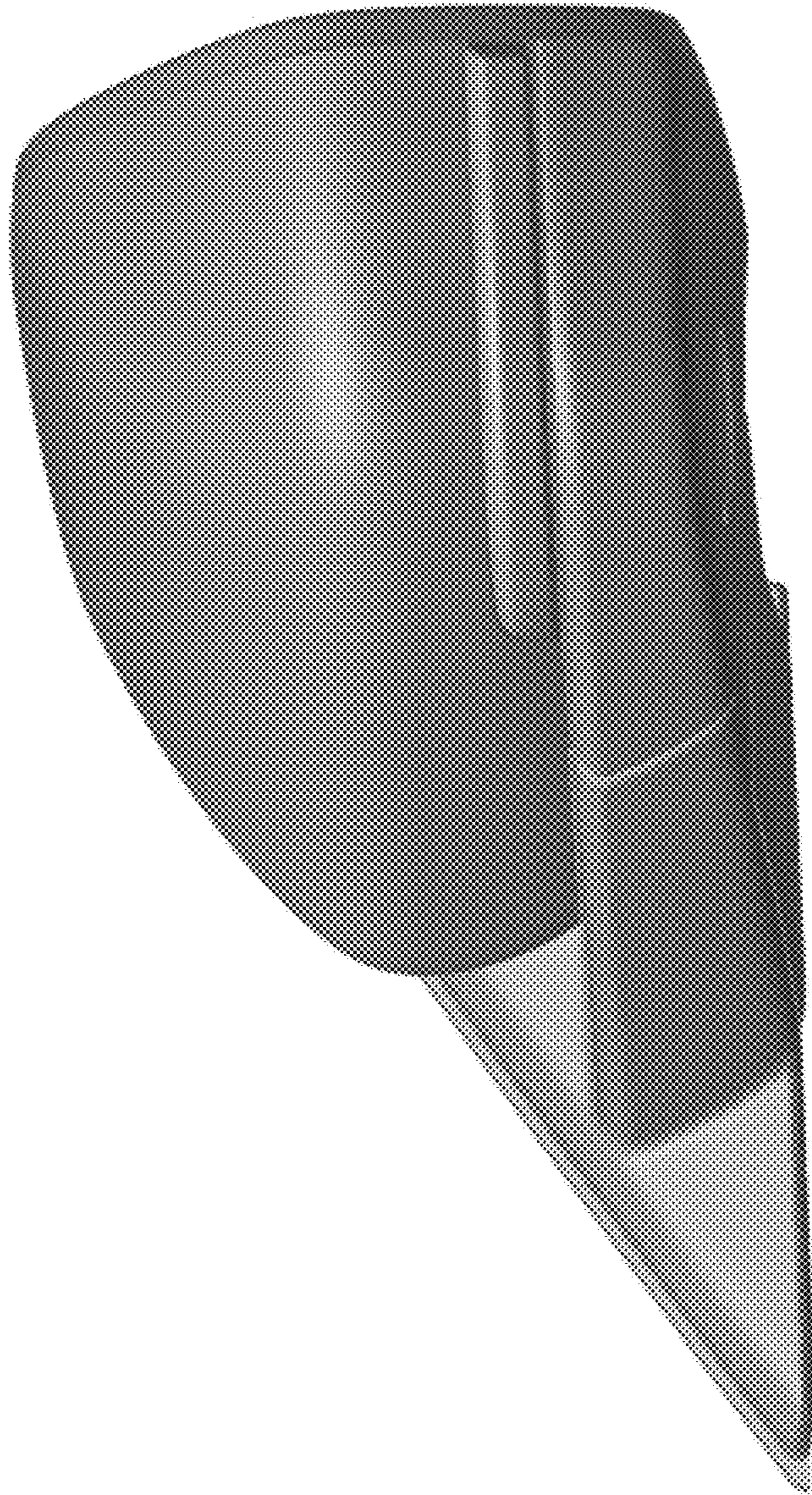

Fig. 3

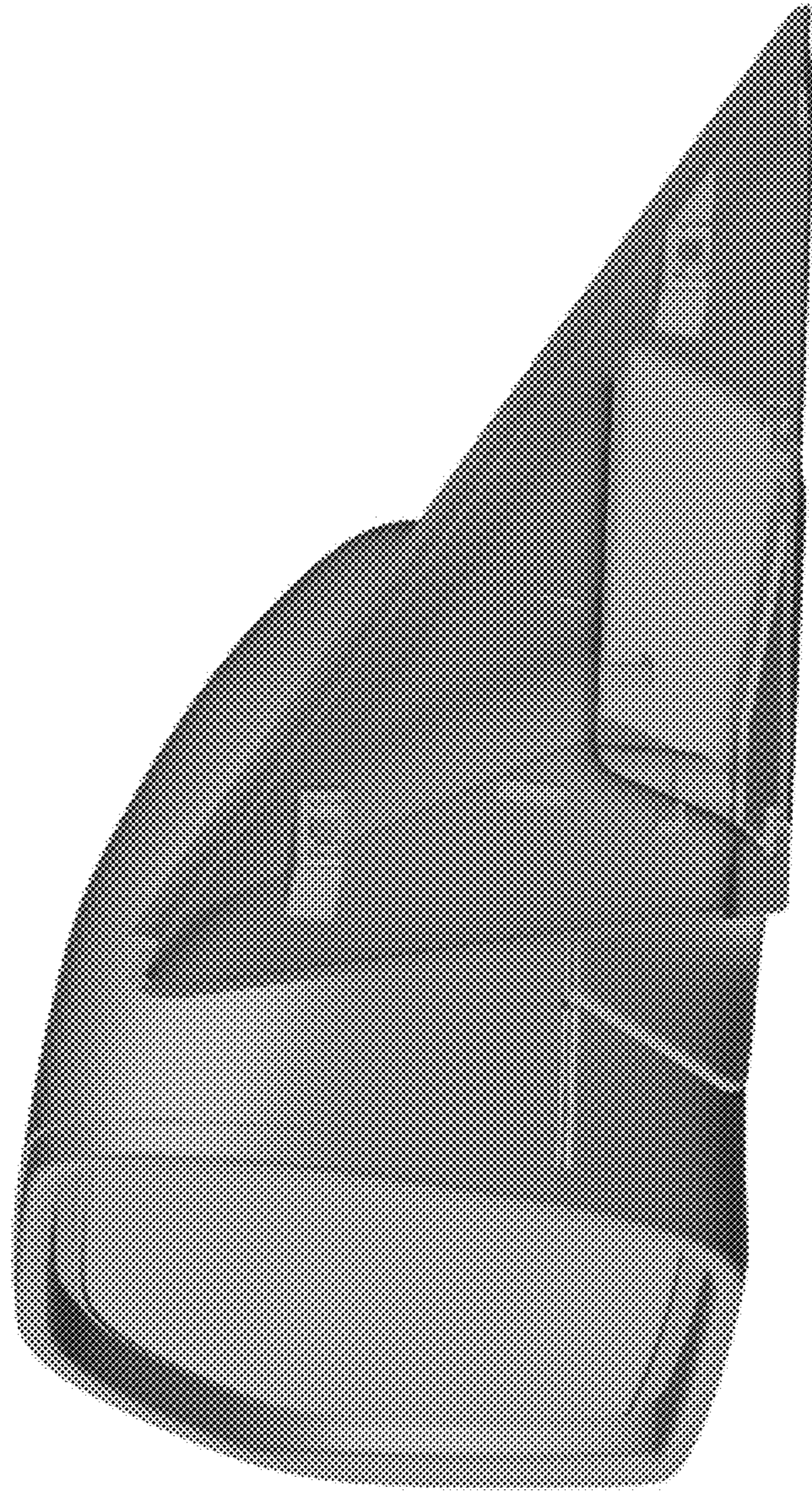

Fig. 4

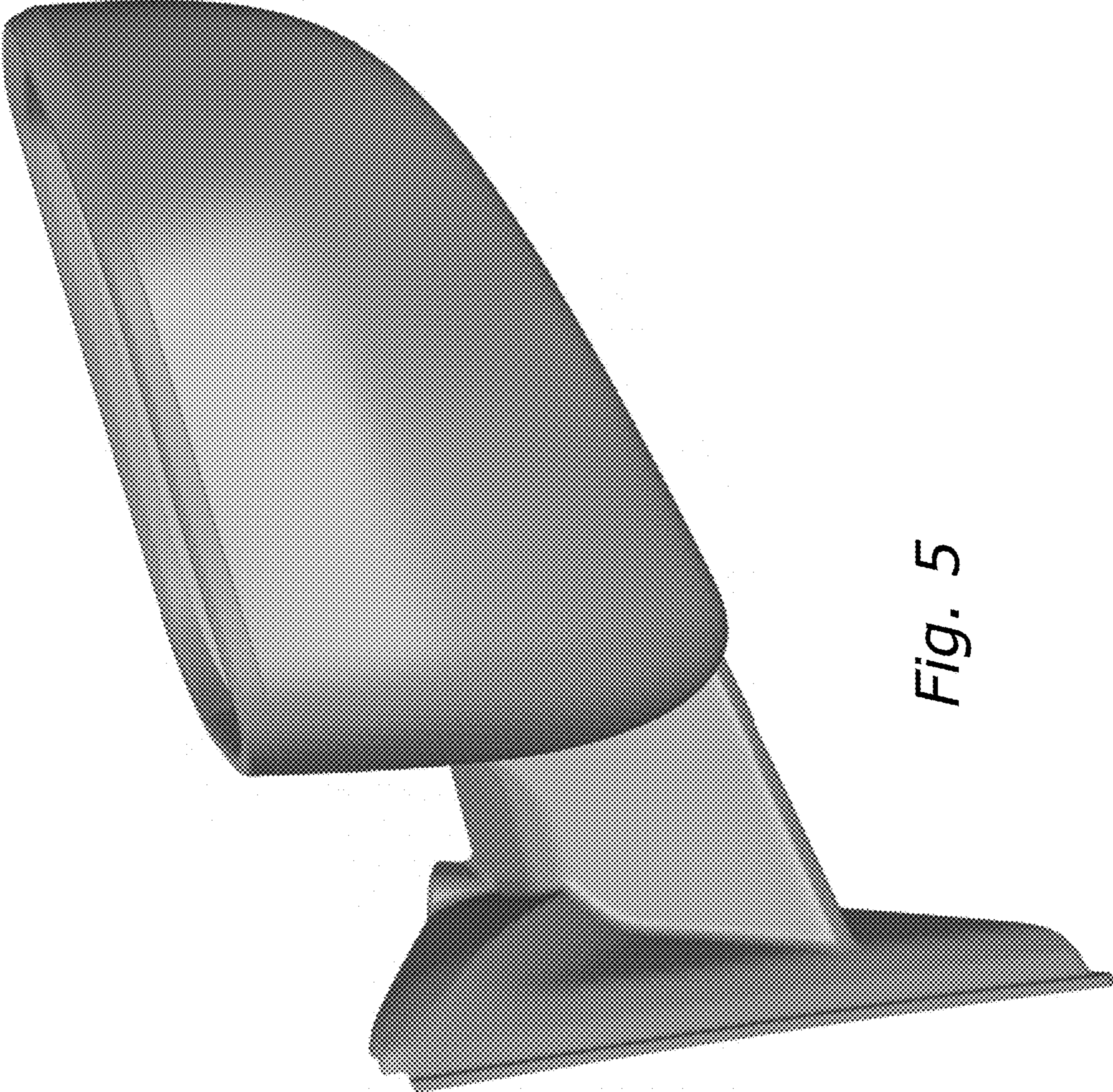

Fig. 5

Fig. 6



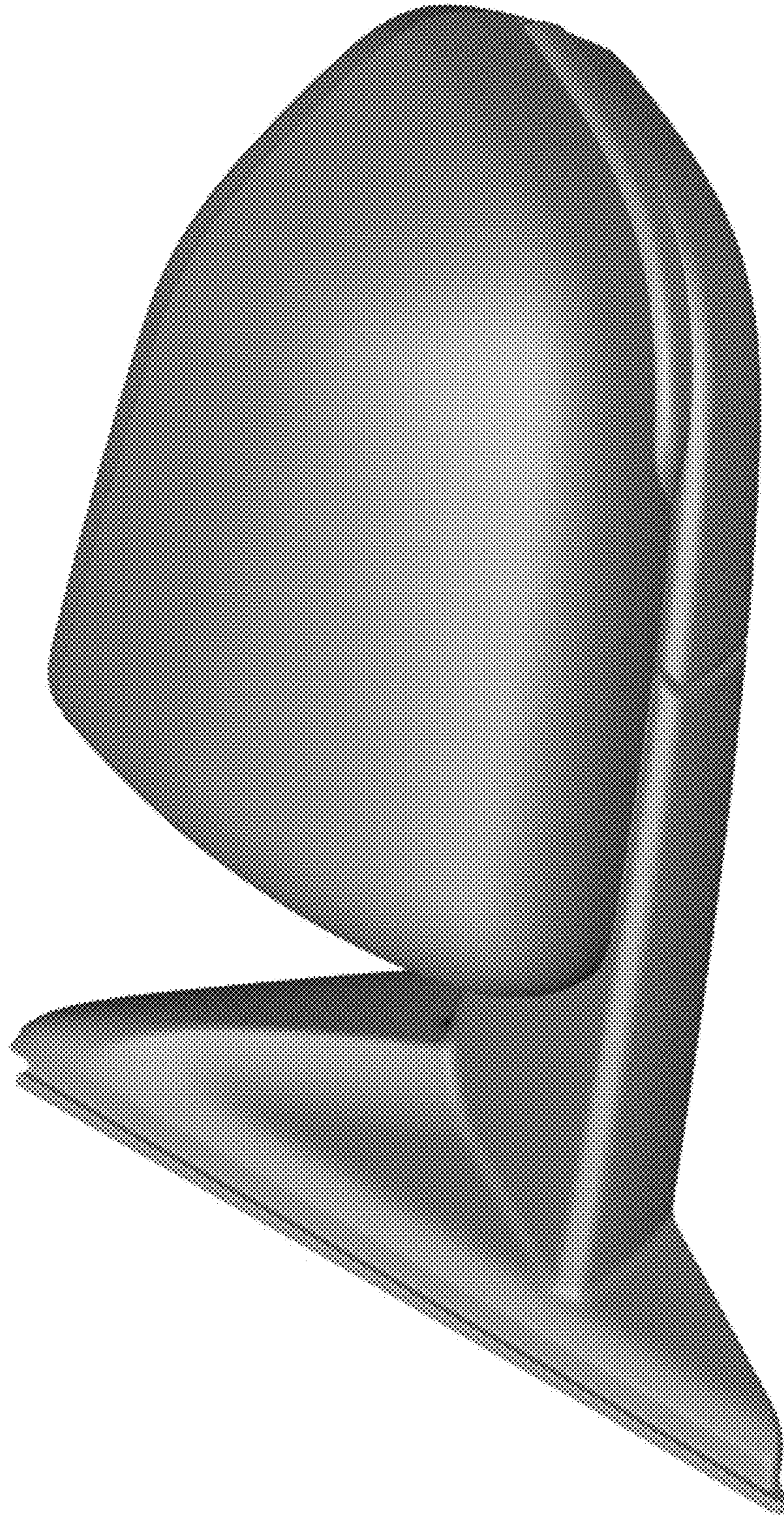

Fig. 7

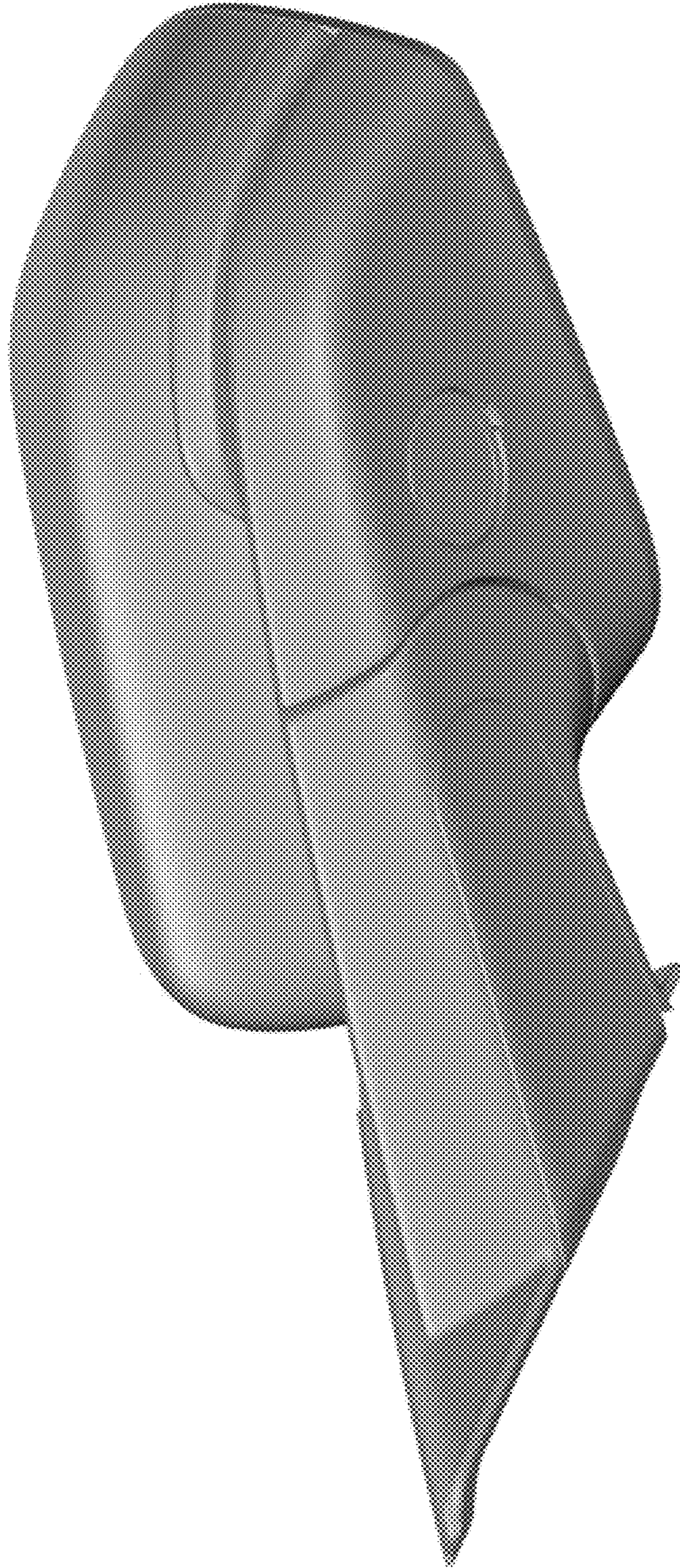

Fig. 8