

US00D944009S

(12) **United States Design Patent** (10) **Patent No.:** **US D944,009 S**
Jusic (45) **Date of Patent:** **** Feb. 22, 2022**

(54) **CASE WITH STRAPS**

(71) Applicant: **Skunk Inc.**, Carson City, CA (US)

(72) Inventor: **Alis Jusic**, Carson City, CA (US)

(73) Assignee: **CaseConcept, LLC**, Carson, CA (US)

(**) Term: **15 Years**

(21) Appl. No.: **29/748,447**

(22) Filed: **Aug. 28, 2020**

(51) **LOC (13) Cl.** **03-01**

(52) **U.S. Cl.**
USPC **D3/284**

(58) **Field of Classification Search**
USPC D3/232, 242, 243, 245, 246, 276, 279,
D3/283, 284, 287, 289, 290, 318, 323,
D3/904, 216; D9/705
CPC A45C 7/00; A45C 3/00; A45C 13/02
See application file for complete search history.

(56) **References Cited**

U.S. PATENT DOCUMENTS

D260,948 S *	9/1981	Katz	D3/287
D268,711 S *	4/1983	Outcalt	D3/268
D422,181 S *	4/2000	Birutis	D7/607
D455,551 S *	4/2002	Stephens	D3/276
D457,314 S *	5/2002	Stephens	D3/276
D512,564 S *	12/2005	Teitloff	D3/257
D516,870 S *	3/2006	Martinez	D3/289
D530,081 S *	10/2006	Moon	D3/232
D548,462 S *	8/2007	Aliberti		
D707,963 S *	7/2014	Szewczyk	D3/232
D715,541 S *	10/2014	Morszeck	D3/232
D841,974 S *	3/2019	Peng	D3/205
D850,105 S *	6/2019	Case	D3/289
D878,035 S *	3/2020	Peng	D3/205
D880,854 S *	4/2020	Jusic	D3/245
D890,581 S *	7/2020	Gonzalez	D7/709

D893,871 S *	8/2020	Plunkett	D3/285
D927,849 S *	8/2021	Imsand	D3/283
2002/0096409 A1 *	7/2002	Roegner	A45C 7/0095 190/109

(Continued)

FOREIGN PATENT DOCUMENTS

CN 304329927 * 10/2017

OTHER PUBLICATIONS

Amazon.com: Site Visited Nov. 1, 2021, Smart Stash Smell Proof Case, First Available Aug. 13, 2018, <https://www.amazon.com/Smell-Proof-Bag-Container-Discreet/dp/B07GDWZT8L/ref> (Year: 2018).*

(Continued)

Primary Examiner — Brett Miller
Assistant Examiner — Jessica M Gebhart
(74) *Attorney, Agent, or Firm* — Traverse Legal, PLC

(57) **CLAIM**

I claim the ornamental design for a case with straps, as shown and described.

DESCRIPTION

FIG. 1 is a perspective view of a case with straps;
FIG. 2 is a front view thereof;
FIG. 3 is a rear view thereof;
FIG. 4 is a right side view thereof;
FIG. 5 is a left side view thereof;
FIG. 6 is a top plan view thereof;
FIG. 7 is a bottom plan view thereof; and,
FIG. 8 is a perspective view thereof in an opened configuration.
Each of the dotted lines, dash-dot lines, and dash lines shown in the drawings are included for purposes of illustrating environment and form no part of the claimed design. The surface shading lines show contour and/or distinguish between open and solid areas. The surface shading lines are not surface ornamentation.

1 Claim, 8 Drawing Sheets

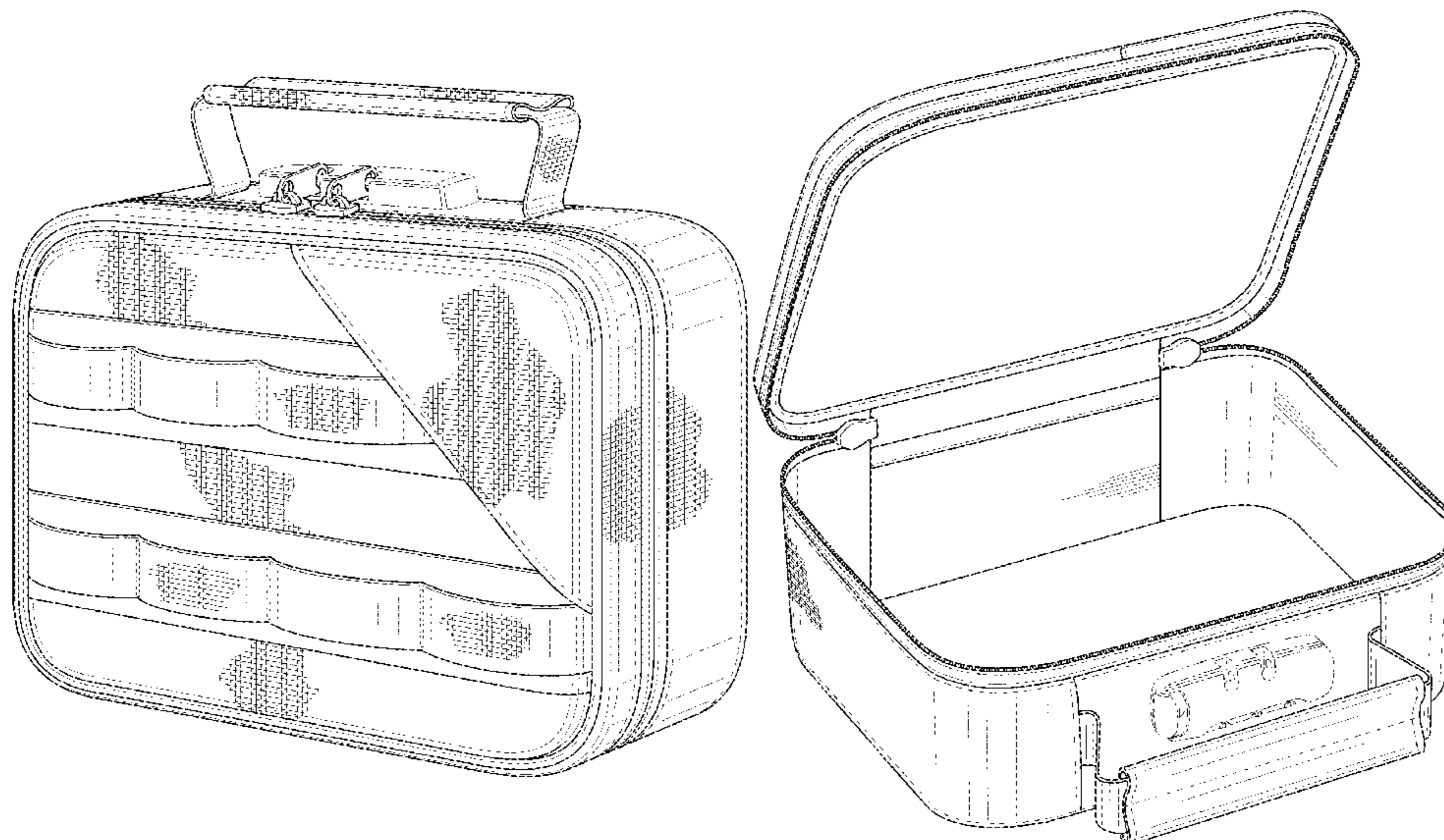

(56)

References Cited

U.S. PATENT DOCUMENTS

2005/0150807 A1* 7/2005 Siwak A45C 7/0022
206/542

OTHER PUBLICATIONS

Amazon.com: Site Visited Nov. 1, 2021, Ozchin Smell Proof Bag with Combination Lock, First Available May 11, 2019, <https://www.amazon.com/Combination-Container-Medicine-Travel-Storage/dp/B07Q5T196M/> (Year: 2019).*

Amazon.com: Site visited Nov. 1, 2021, Medicine RX Safe Medication Travel Bag, First available: Mar. 30, 2017, <https://www.amazon.com/Medicine-Safe-LTB-1-Locking-Travel/dp/B06XY5BT8V/> (Year: 2017).*

Youtube.com, Site Visited Nov. 1, 2021, video published on Mar. 3, 2020 by Shunkbags titled "Wingman." Still was taken at the 2:04 mark in the video, <https://www.youtube.com/watch?v=WcMKPNNYNhg> (Year: 2020).*

* cited by examiner



FIG. 1

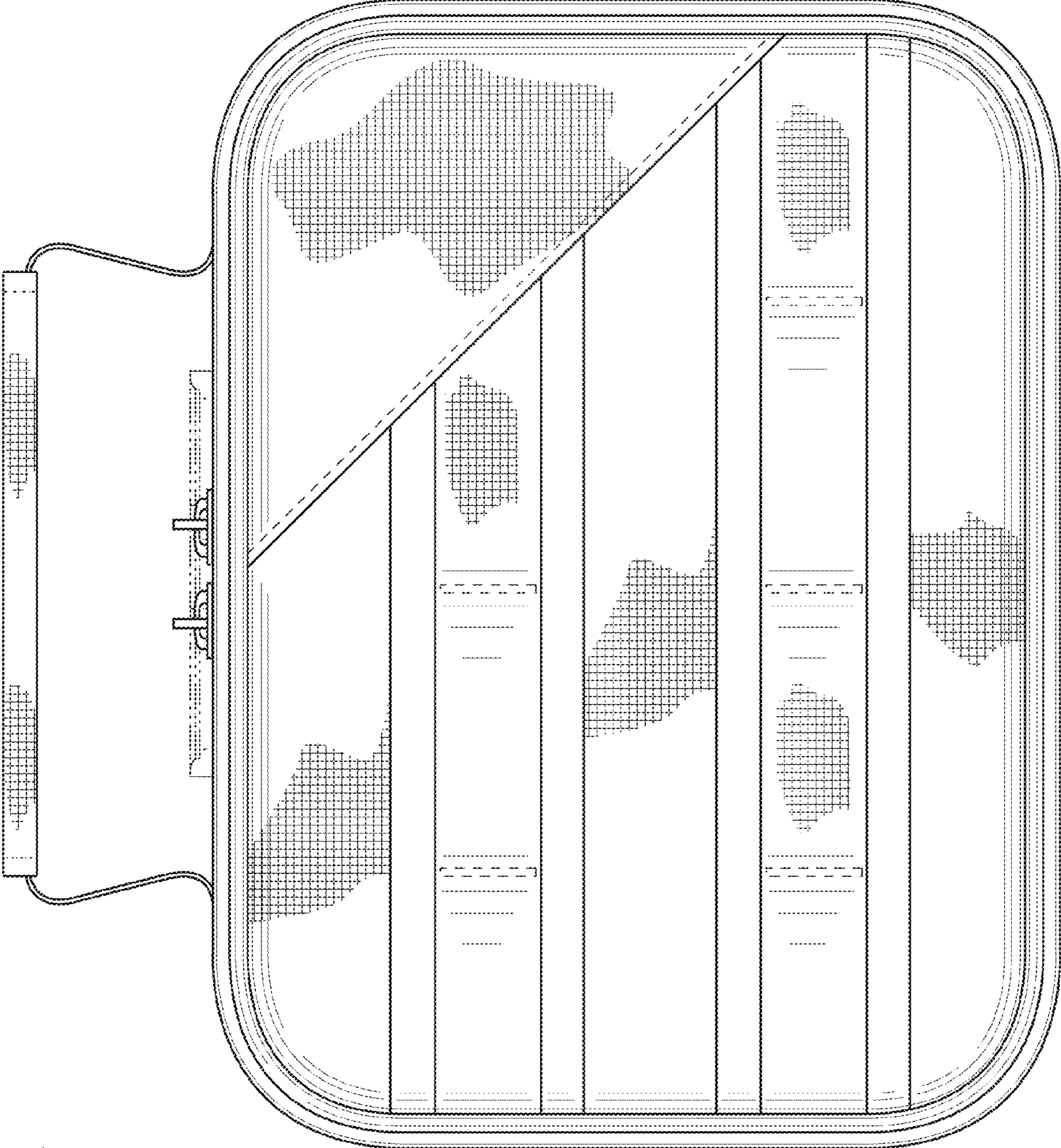

FIG. 2

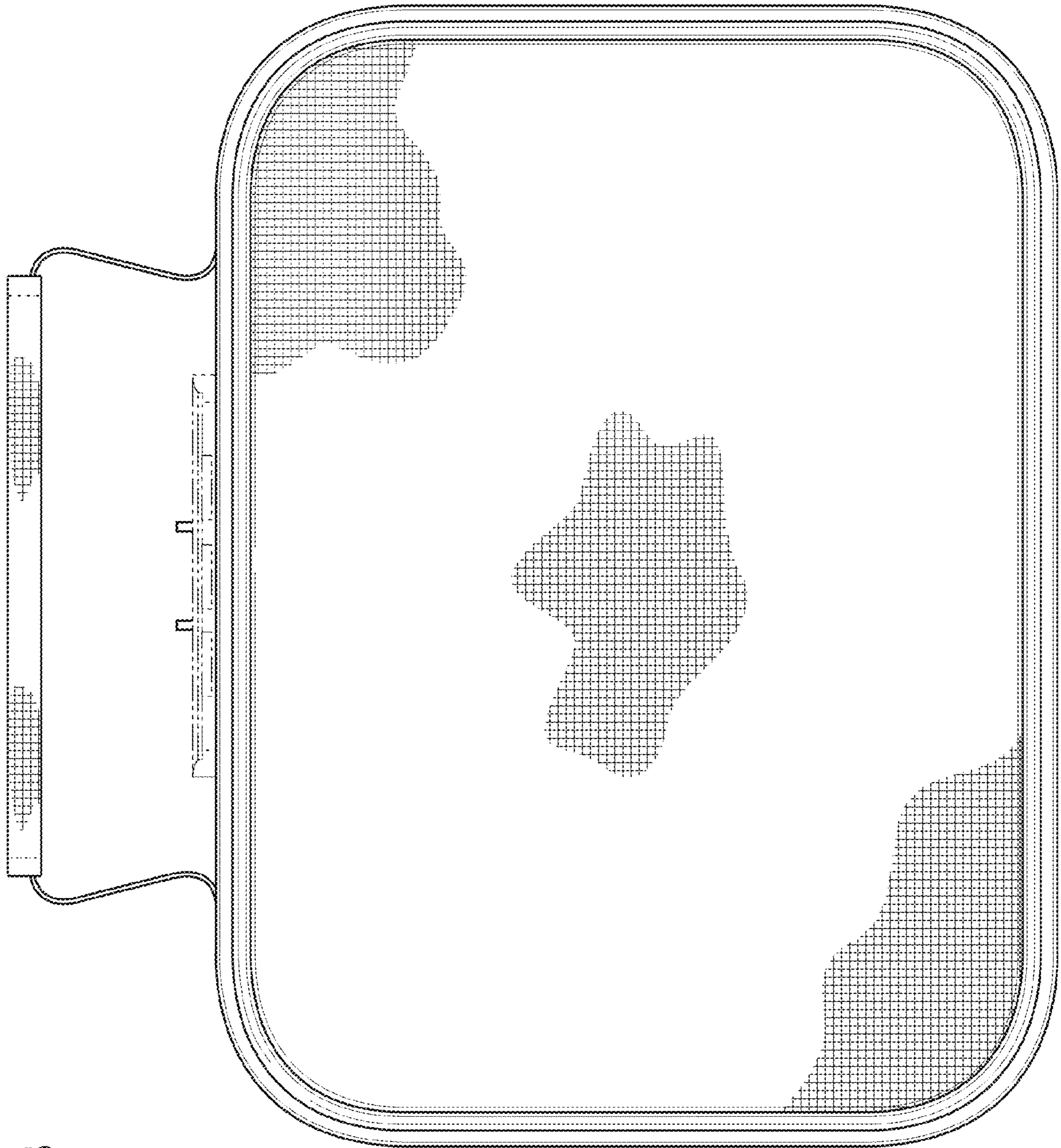

FIG. 3

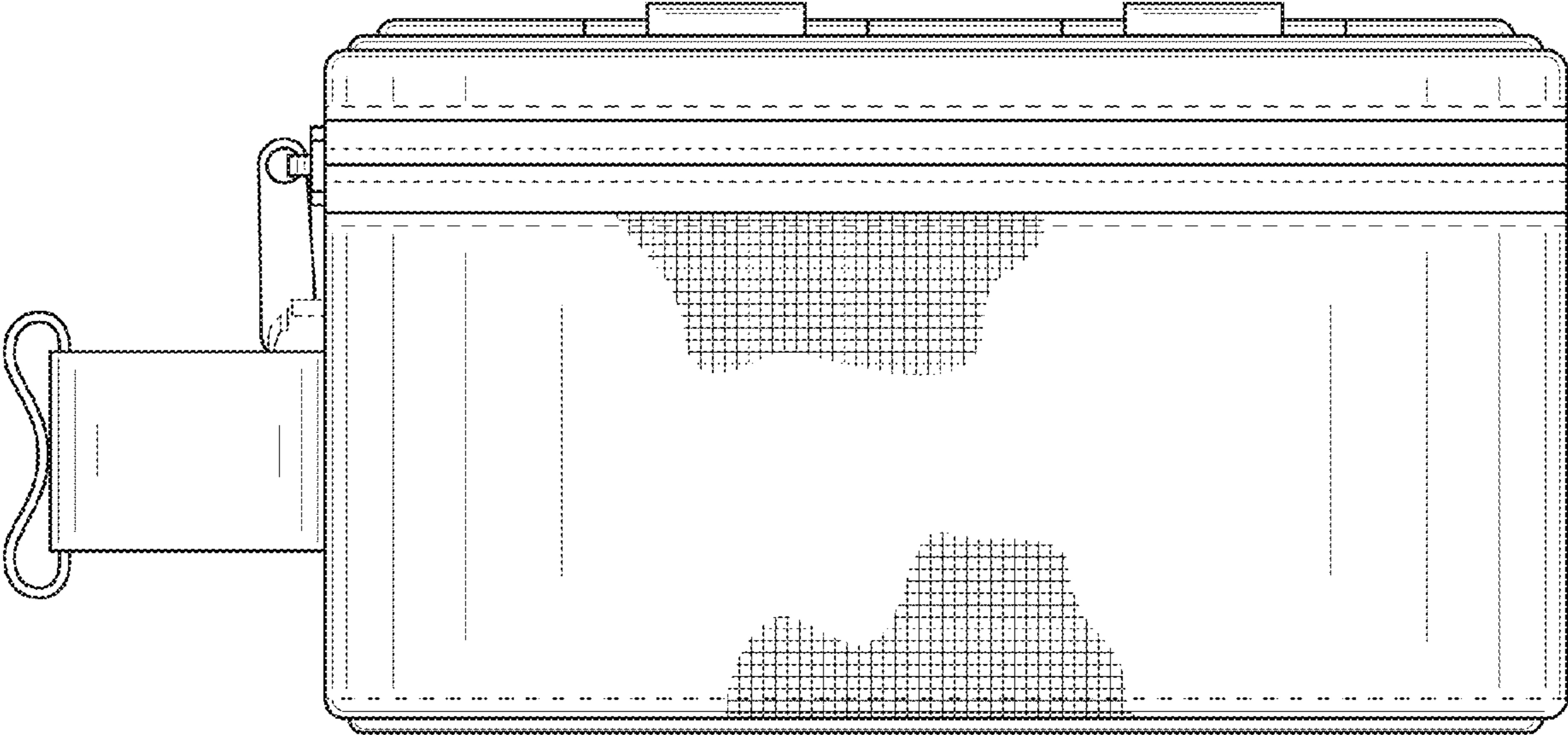

FIG. 4

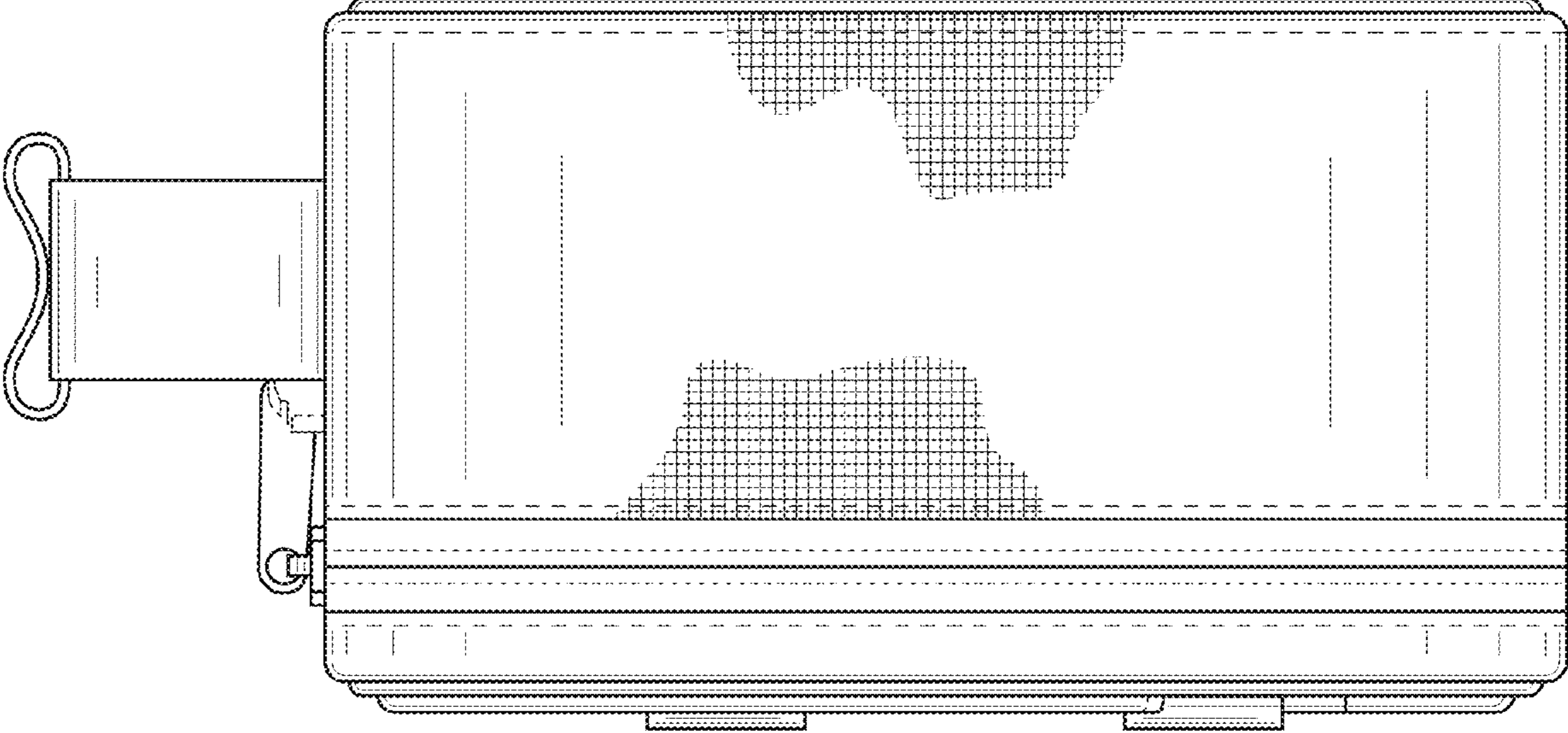

FIG. 5

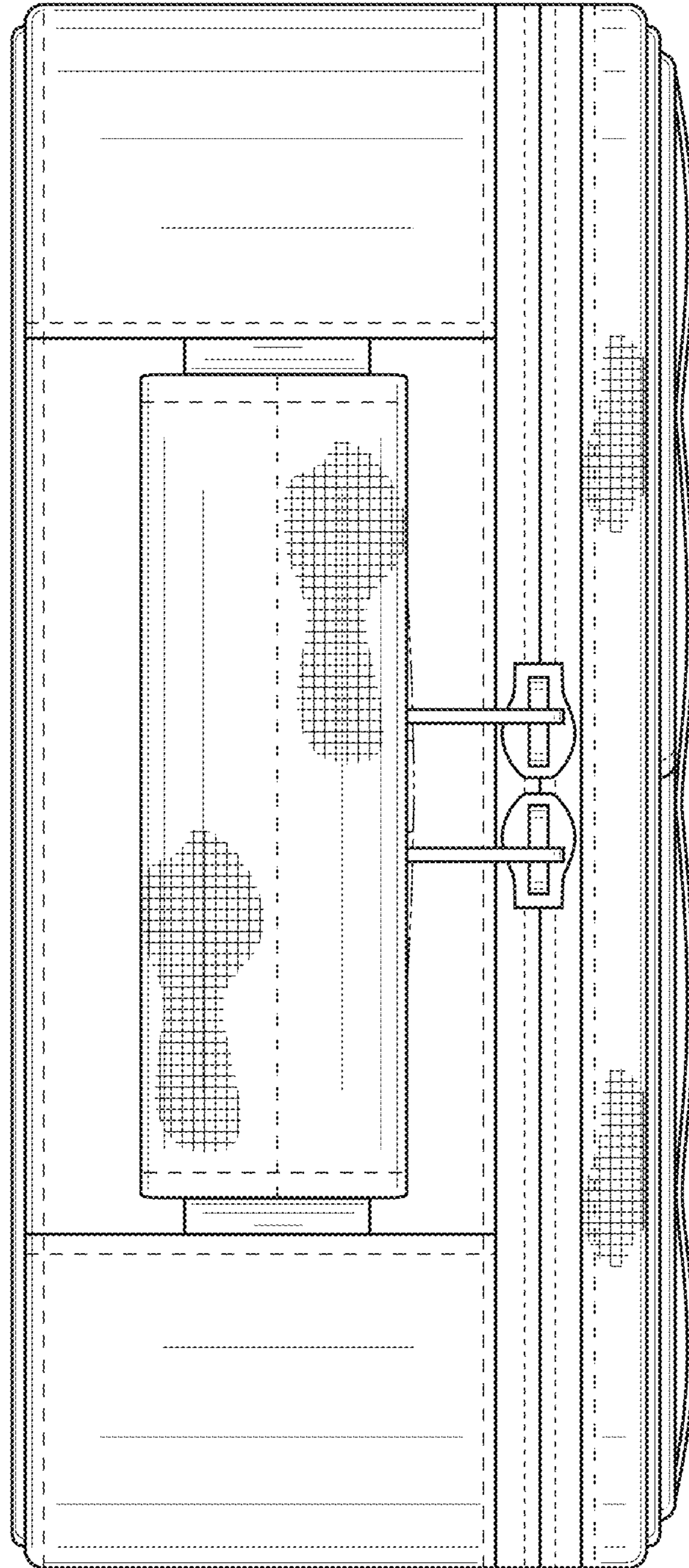

FIG. 6

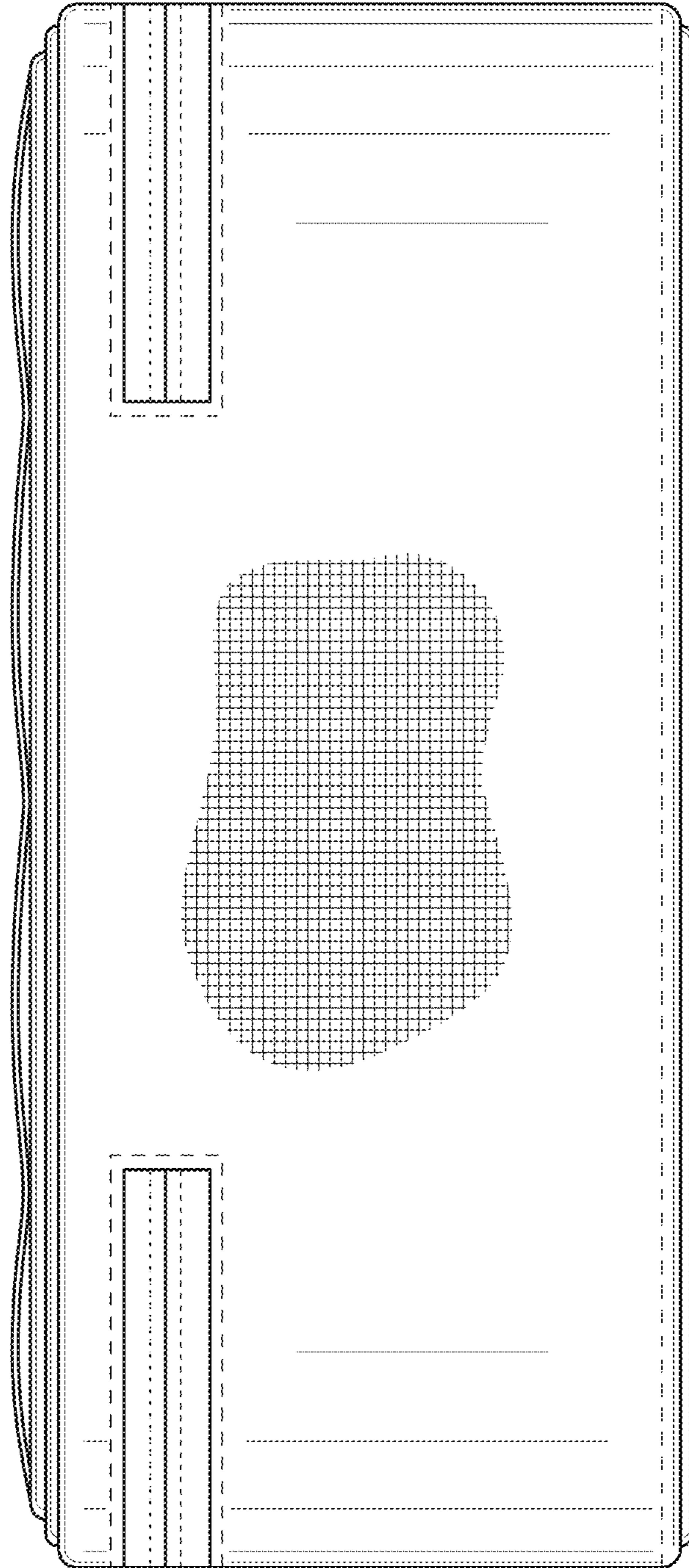

FIG. 7

FIG. 8

