



US00D943899S

(12) **United States Design Patent**  
**Hoang**

(10) **Patent No.:** **US D943,899 S**

(45) **Date of Patent:** **\*\* Feb. 22, 2022**

(54) **SOLE OF A FOOTWEAR ARTICLE**

(71) Applicant: **Salomon S.A.S.**, Epagny Metz-Tessy (FR)

(72) Inventor: **Gia Dat Hoang**, Villaz (FR)

(73) Assignee: **Salomon S.A.S.**, Metz-Tessy (FR)

(\*\*) Term: **15 Years**

(21) Appl. No.: **29/718,607**

(22) Filed: **Dec. 26, 2019**

(51) **LOC (13) Cl.** ..... **02-04**

(52) **U.S. Cl.**  
USPC ..... **D2/953**; D2/947; D2/951; D2/954;  
D2/956; D2/959; D2/960

(58) **Field of Classification Search**  
USPC ..... D2/902, 906, 908, 916, 918, 925,  
D2/946–962, 977; 36/1, 1.5, 3 B, 22 R,  
36/24.5, 25 R, 28, 32 R, 34 R, 59 C,  
36/67 A, 101–107, 114–116, 117.3, 117.4,  
36/124–136  
CPC ..... A43B 13/00; A43B 13/02; A43B 13/023;  
A43B 13/026; A43B 13/04; A43B 13/08;  
A43B 13/10; A43B 13/12; A43B 13/14;  
A43B 13/141; A43B 13/143; A43B  
13/16; A43B 13/18; A43B 13/181; A43B  
13/187; A43B 13/189; A43B 13/20; A43B  
13/22; A43B 13/223; A43B 13/24; A43B  
13/28; A43B 13/30; A43B 13/32; A43B  
13/34; A43B 13/36

See application file for complete search history.

(56) **References Cited**

**U.S. PATENT DOCUMENTS**

D331,313 S \* 12/1992 Lesbirel ..... D2/954  
D333,909 S \* 3/1993 Hatfield ..... D2/954  
D350,432 S \* 9/1994 Saez ..... D2/961  
D401,755 S 12/1998 Zinovieff  
D404,542 S 1/1999 Donnadiou et al.

(Continued)

**OTHER PUBLICATIONS**

Sonic 3 Balance, Salomon.com, [online], [site visited Jan. 28, 2021]. <URL: Sonic 3 Balance—Road Running Shoes—Shoes—Men (salomon.com)> (Year: 2021).\*

(Continued)

*Primary Examiner* — Jonathan J Han

(74) *Attorney, Agent, or Firm* — Terence P. O'Brien

(57) **CLAIM**

I claim the ornamental design for a sole of a footwear article, as shown and described.

**DESCRIPTION**

FIG. 1 is a top, side perspective view of a sole of a footwear article;

FIG. 2 is a first side view of the sole of a footwear article of FIG. 1;

FIG. 3 is a second side view of the sole of a footwear article of FIG. 1;

FIG. 4 is a front view of the sole of a footwear article of FIG. 1;

FIG. 5 is a rear view of the sole of a footwear article of FIG. 1;

FIG. 6 is a top view of the sole of a footwear article of FIG. 1; and,

FIG. 7 is a bottom view of the sole of a footwear article of FIG. 1.

The broken lines depicting the upper of the footwear article in FIG. 1 through 7 views show environmental structure forming no part of the claimed design. The dot-dash lines in FIGS. 1 through 4 and FIG. 6 show the boundary of the claimed design. The broken lines immediately within the perimeters of the solid lines in FIG. 7 are boundary lines between the claimed design and surfaces forming no part of the claimed design. The curving broken lines in FIG. 7 show edges of the sole forming no part of the claimed design that are also boundaries between the shaded, claimed surfaces and the unshaded surfaces forming no part of the claimed design. The boundary lines also form no part of the claimed design.

**1 Claim, 7 Drawing Sheets**

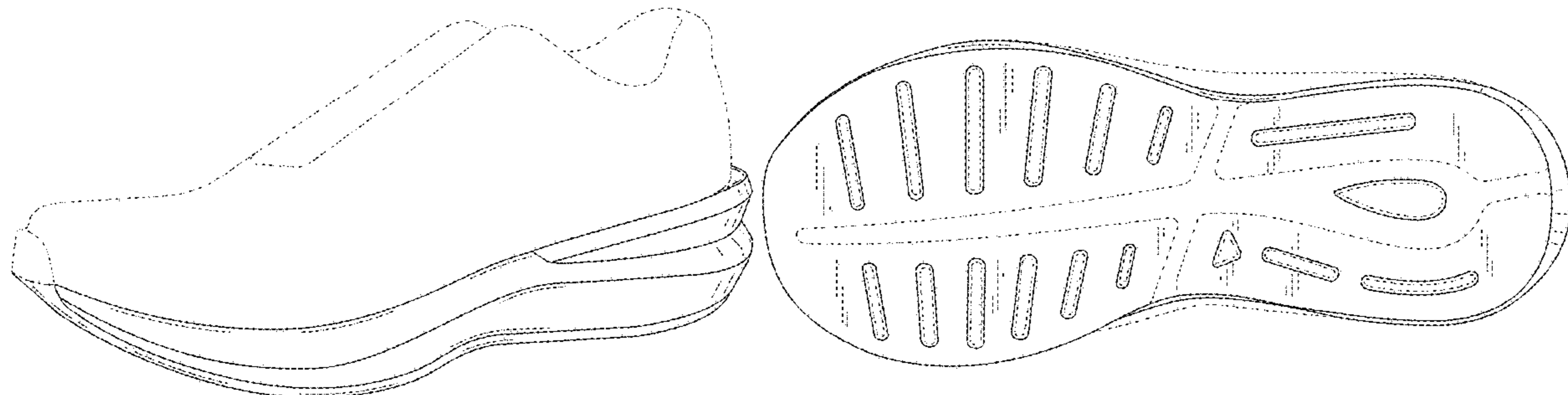

(56)

References Cited

U.S. PATENT DOCUMENTS

D404,543 S	1/1999	Donnadieu et al.	D622,051 S	8/2010	Leleu
D412,131 S	7/1999	Bent et al.	D622,052 S	8/2010	Grenet
D413,427 S	11/1999	Fellouhe	D622,053 S	8/2010	Grenet
D415,875 S	11/1999	Falguere	D622,054 S	8/2010	Bosomworth
D425,693 S	5/2000	Fellouhe	D622,055 S	8/2010	Bosomworth
D426,949 S	6/2000	Barret	D623,391 S	9/2010	Leleu
D434,212 S	11/2000	Laberge	D623,392 S	9/2010	Grenet
D434,552 S	12/2000	Burt	D623,839 S	9/2010	Leleu
D434,553 S	12/2000	Burt	D629,190 S	12/2010	Bosomworth
D434,554 S	12/2000	Laberge	D629,599 S	12/2010	Bosomworth
D434,894 S	12/2000	Burt	D630,423 S *	1/2011	Asquini ..... D2/956
D434,895 S	12/2000	Laberge	D642,367 S	8/2011	Fuhrer
D435,165 S	12/2000	Burt	D644,019 S	8/2011	Grenet
D435,336 S	12/2000	Barret et al.	D644,824 S	9/2011	Leleu
D435,718 S	1/2001	Laberge	D671,301 S *	11/2012	Dombrow ..... D2/951
D436,433 S	1/2001	Laberge	D671,731 S	12/2012	Amphyon
D443,131 S	6/2001	Laberge	D679,081 S	4/2013	Bosomworth
D443,408 S	6/2001	Laberge	D679,082 S	4/2013	Bosomworth
D446,004 S	8/2001	Burt	D679,083 S	4/2013	Bosomworth
D451,267 S	12/2001	Laberge et al.	D679,084 S	4/2013	Grenet
D451,268 S	12/2001	Laberge et al.	D679,085 S	4/2013	Grenet
D451,269 S	12/2001	Burt	D679,903 S	4/2013	Grenet
D452,068 S	12/2001	Laberge et al.	D680,314 S	4/2013	Amphyon
D452,368 S	12/2001	Chaigne	D680,315 S	4/2013	Amphyon
D452,607 S	1/2002	Sakai	D680,728 S	4/2013	Stryjak
D453,616 S	1/2002	Sakai	D690,491 S	10/2013	Bosomworth
D455,251 S	4/2002	Sakai	D690,492 S	10/2013	Bosomworth
D457,296 S	5/2002	Burt	D690,493 S	10/2013	Bosomworth
D459,870 S	7/2002	St-Louis	D690,494 S	10/2013	Bosomworth
D460,250 S	7/2002	Hillyer	D690,495 S	10/2013	Bosomworth
D460,583 S	7/2002	Sakai	D690,496 S	10/2013	Leleu
D460,610 S	7/2002	Sakai	D690,923 S	10/2013	Amphyon
D461,946 S	8/2002	Burt	D693,557 S	11/2013	Grenet
D464,479 S	10/2002	Banik	D693,558 S	11/2013	Bosomworth
D465,909 S	11/2002	Ornerakis	D701,029 S	3/2014	Grenet
D467,062 S	12/2002	Delgorgue et al.	D701,030 S	3/2014	Grenet
D467,064 S	12/2002	Hillyer	D701,031 S	3/2014	Grenet
D467,724 S	12/2002	Hillyer	D701,033 S	3/2014	Leleu
D471,700 S	3/2003	Banik	D701,384 S	3/2014	Leleu
D472,040 S	3/2003	Banik	D706,025 S	3/2014	Ameye
D475,189 S	3/2003	Laberge et al.	D711,639 S	8/2014	Fuhrer
D475,515 S	6/2003	St-Louis	D711,640 S	8/2014	Amphyon
D475,516 S	6/2003	Laberge	D711,641 S	8/2014	Grenet et al.
D475,517 S	6/2003	St-Louis	D711,642 S	8/2014	Bosomworth
D479,391 S	9/2003	Hillyer	D711,643 S	8/2014	Bosomworth
D479,392 S	9/2003	Hillyer	D717,037 S	11/2014	Bosomworth
D479,644 S	9/2003	Sakai	D717,530 S	11/2014	Leleu
D481,530 S	11/2003	Hillyer	D717,531 S	11/2014	Bosomworth
D482,515 S	11/2003	St-Louis	D717,532 S	11/2014	Grenet
D482,858 S	12/2003	Hillyer	D717,533 S	11/2014	Grenet
D482,859 S	12/2003	Laberge	D717,534 S	11/2014	Amphyon
D482,861 S	12/2003	St-Louis	D718,030 S	11/2014	Fuhrer et al.
D483,938 S	12/2003	Laberge	D718,521 S	12/2014	Bosomworth
D485,428 S	1/2004	Koo	D722,429 S	2/2015	Amphyon
D485,429 S	1/2004	Koo	D725,362 S	3/2015	Bosomworth
D485,669 S	1/2004	Koo	D725,363 S	3/2015	Fuhrer et al.
D485,670 S	1/2004	Laberge	D725,364 S	3/2015	Fuhrer et al.
D486,301 S	2/2004	Koo	D725,365 S	3/2015	Grenet
D487,339 S	3/2004	Laberge	D725,366 S	3/2015	Grenet
D488,917 S	4/2004	Koo	D725,367 S	3/2015	Bosomworth
D489,168 S	5/2004	Laberge	D725,368 S	3/2015	Portailler
D493,955 S	8/2004	Gay	D725,885 S	4/2015	Amphyon
D494,350 S	8/2004	Hillyer	D725,886 S	4/2015	Grenet
D502,310 S	3/2005	Tresser	D725,887 S	4/2015	Bosomworth
D513,666 S	1/2006	Bertholon	D725,888 S	4/2015	Bosomworth
D513,847 S	1/2006	Laberge	D725,889 S	4/2015	Amphyon
D515,799 S	2/2006	Bertholon	D725,890 S	4/2015	Bosomworth
D515,800 S	2/2006	Bertholon	D725,891 S	4/2015	Bosomworth
D529,265 S *	10/2006	Corbi Rico ..... D2/957	D725,892 S	4/2015	Bosomworth
D553,333 S *	10/2007	Caine ..... D2/952	D725,893 S	4/2015	Grenet
D586,093 S *	2/2009	Mermet ..... D2/951	D725,894 S	4/2015	Bosomworth
D590,586 S *	4/2009	Harlow ..... D2/951	D726,402 S	4/2015	Bosomworth
D621,144 S *	8/2010	McClaskie ..... D2/953	D726,403 S	4/2015	Bosomworth
D621,594 S *	8/2010	Diaz ..... D2/953	D727,007 S	4/2015	Bosomworth
D621,597 S	8/2010	Grenet	D727,008 S	4/2015	Amphyon
			D731,772 S	6/2015	Bosomworth et al.
			D731,773 S	6/2015	Bosomworth et al.
			D731,774 S	6/2015	Antonelli et al.
			D731,775 S	6/2015	Bosomworth et al.

(56)

References Cited

U.S. PATENT DOCUMENTS

D731,776 S 6/2015 Portailier  
 D731,777 S 6/2015 Grenet et al.  
 D731,778 S 6/2015 Grenet et al.  
 D732,268 S 6/2015 Grenet et al.  
 D737,036 S 8/2015 Bosomworth  
 D739,134 S 9/2015 Salmon  
 D740,537 S 10/2015 Fuhrer et al.  
 D742,109 S 10/2015 Grenet  
 D744,211 S \* 12/2015 Kirschner ..... D2/954  
 D753,382 S 4/2016 Lamont  
 D753,383 S 4/2016 Nikolic  
 D777,412 S \* 1/2017 Antonelli ..... D2/951  
 D789,061 S 6/2017 Nikolic  
 D789,062 S 6/2017 Grenet  
 D789,671 S 6/2017 Chung  
 D790,187 S 6/2017 Portailier  
 D790,188 S 6/2017 Portailier et al.  
 D798,036 S \* 9/2017 Opie ..... D2/953  
 D803,530 S 11/2017 Nikolic  
 D811,067 S \* 2/2018 Matthews ..... D2/960  
 D812,872 S \* 3/2018 Palmer ..... D2/947  
 D812,873 S 3/2018 Lapouille  
 D812,874 S 3/2018 Lapouille  
 D812,879 S 3/2018 Lapouille  
 D812,880 S 3/2018 Lapouille  
 D853,696 S \* 7/2019 Roxe ..... D2/923  
 D858,963 S \* 9/2019 Holmes ..... D2/951  
 D879,437 S \* 3/2020 Brosseau ..... D2/959

D879,438 S \* 3/2020 Brosseau ..... D2/959  
 D885,729 S \* 6/2020 Swierszczyk ..... D2/953  
 D890,491 S \* 7/2020 Petrenka ..... D2/953  
 D892,481 S \* 8/2020 Fontaine ..... D2/953  
 D893,140 S \* 8/2020 Felloni ..... D2/939  
 D894,565 S \* 9/2020 Lopez Cali ..... D2/957  
 D894,572 S \* 9/2020 Lopez Cali ..... D2/960  
 D899,051 S \* 10/2020 Radabaugh ..... D2/953  
 D900,446 S \* 11/2020 Jury ..... D2/953  
 D901,865 S \* 11/2020 Cruz ..... D2/953  
 D903,264 S \* 12/2020 Beaver ..... D2/960  
 D903,265 S \* 12/2020 Beaver ..... D2/960  
 D903,266 S \* 12/2020 Fontaine ..... D2/960  
 2015/0135558 A1 \* 5/2015 Inomata ..... A43B 13/14  
 36/25 R  
 2018/0092431 A1 \* 4/2018 Luchi ..... A43B 13/125  
 2018/0295935 A1 \* 10/2018 Giandolini ..... A43B 13/181

OTHER PUBLICATIONS

Salomon Sonic 3 Balance Performance Review, Ibelieveintherun.com, Apr. 20, 2020, Austin Bonds, Erin Surette, [online], [site visited Jan. 28, 2021]. <URL: Salomon Sonic 3 Balance Performance Review » Believe in the Run> (Year: 2020).\*

Nike Men's Air Zoom Pegasus 34 Running Shoe, Amazon.com, Date First Available: May 16, 2017, [online], [site visited Jan. 28, 2021]. <URL: Amazon.com | Nike Men's Air Zoom Pegasus 34 Running Shoe | Road Running> (Year: 2017).\*

\* cited by examiner

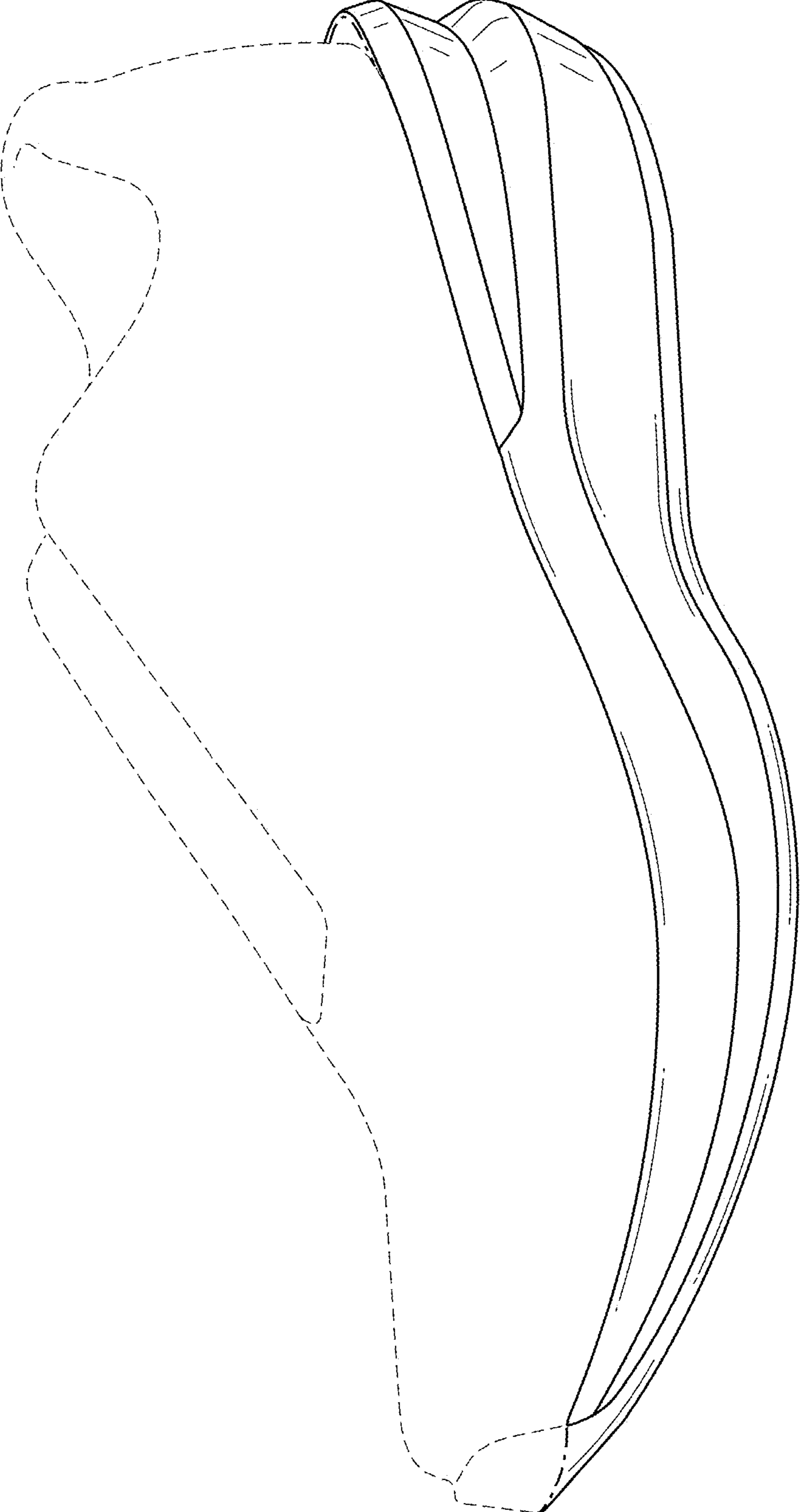

FIG. 1

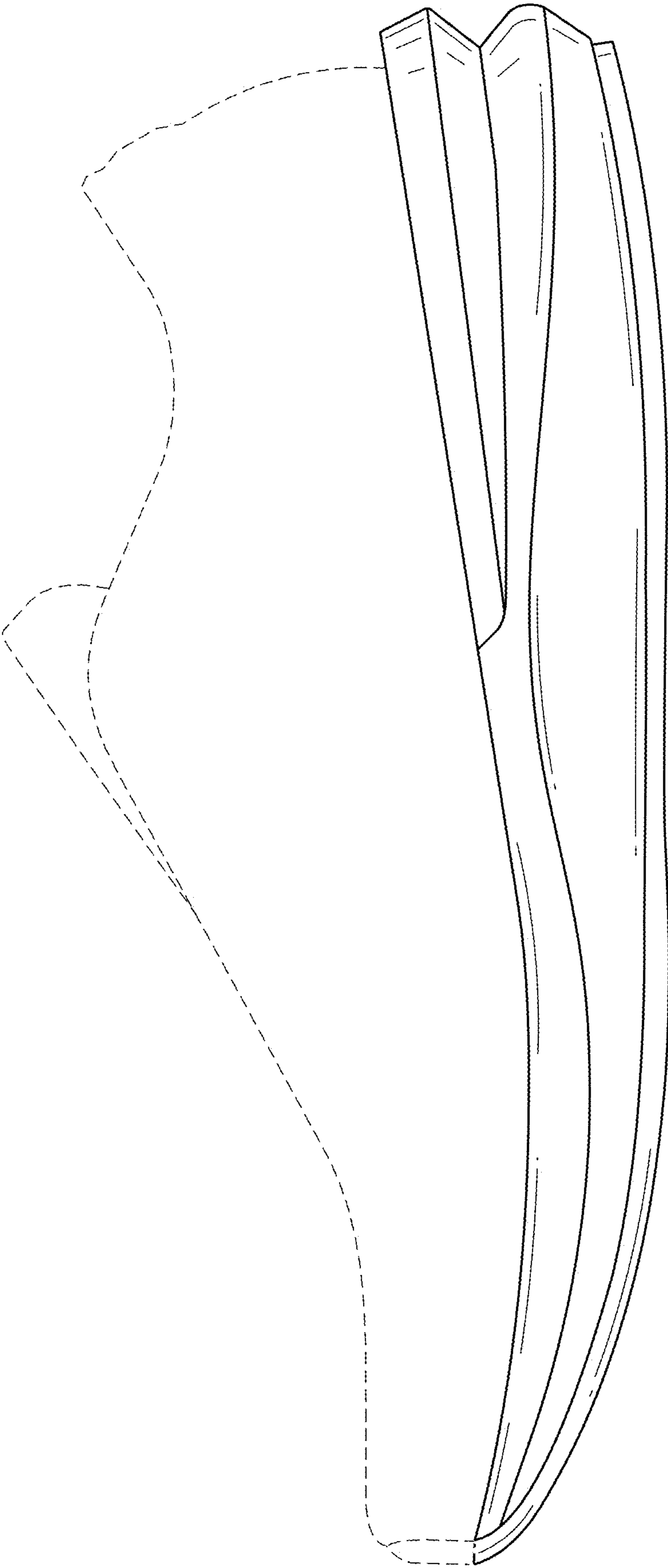

FIG. 2

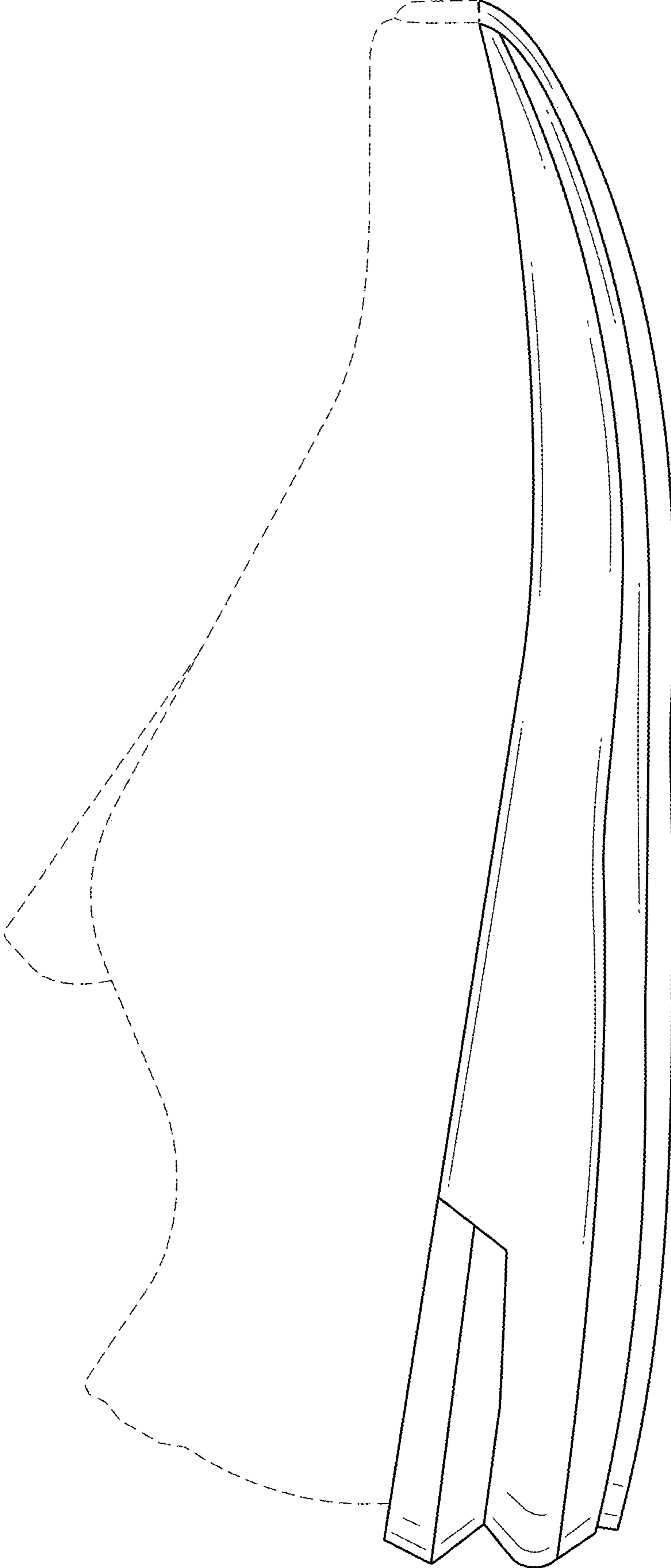

FIG. 3

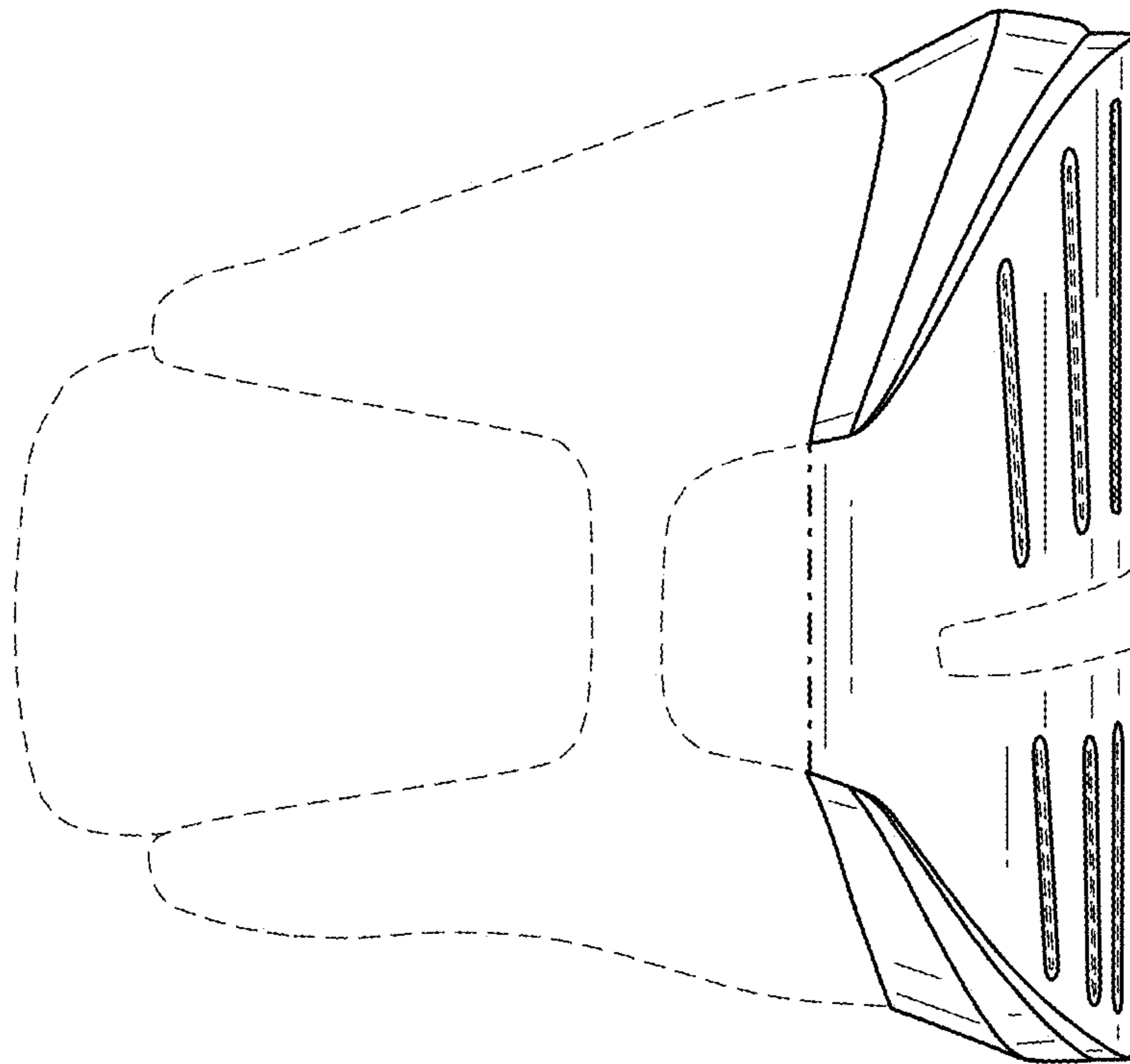

FIG. 4

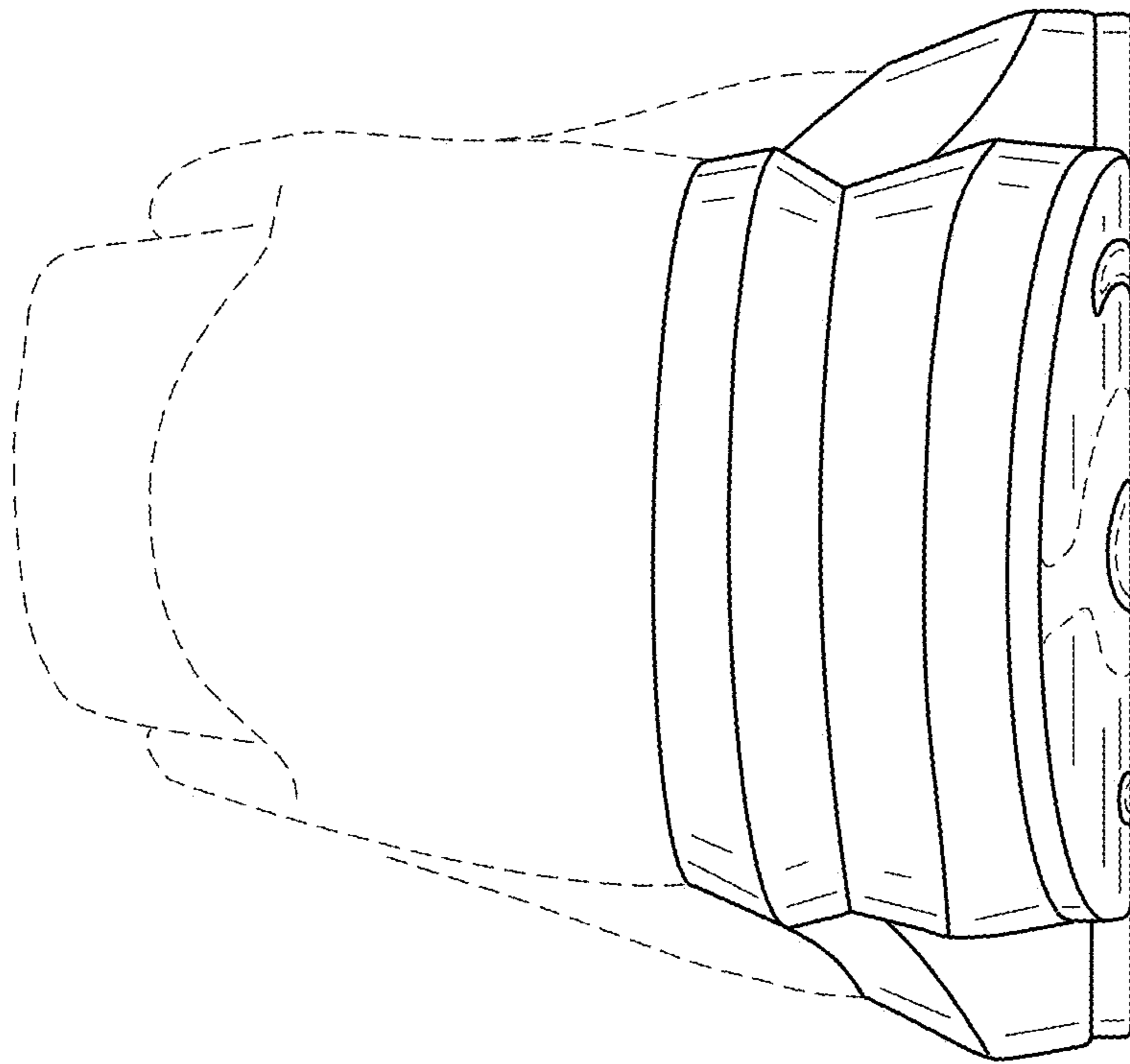

FIG. 5



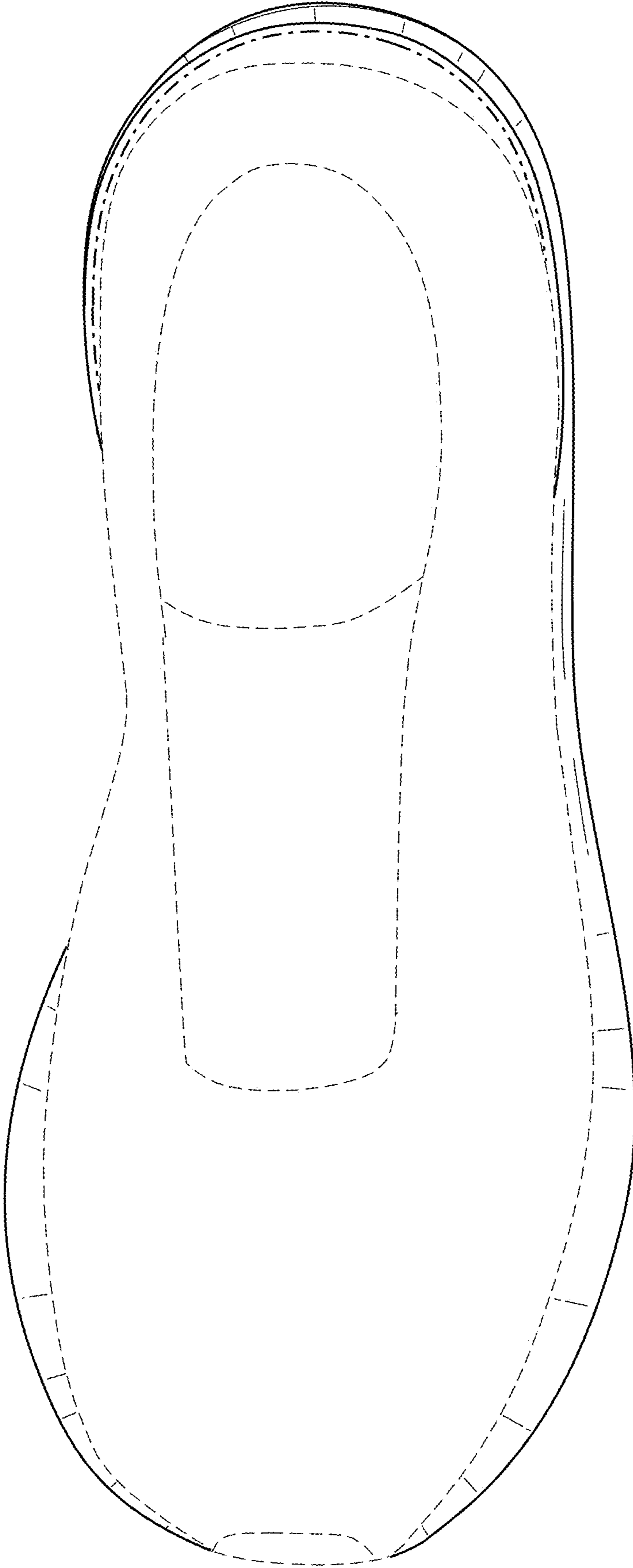

FIG. 6

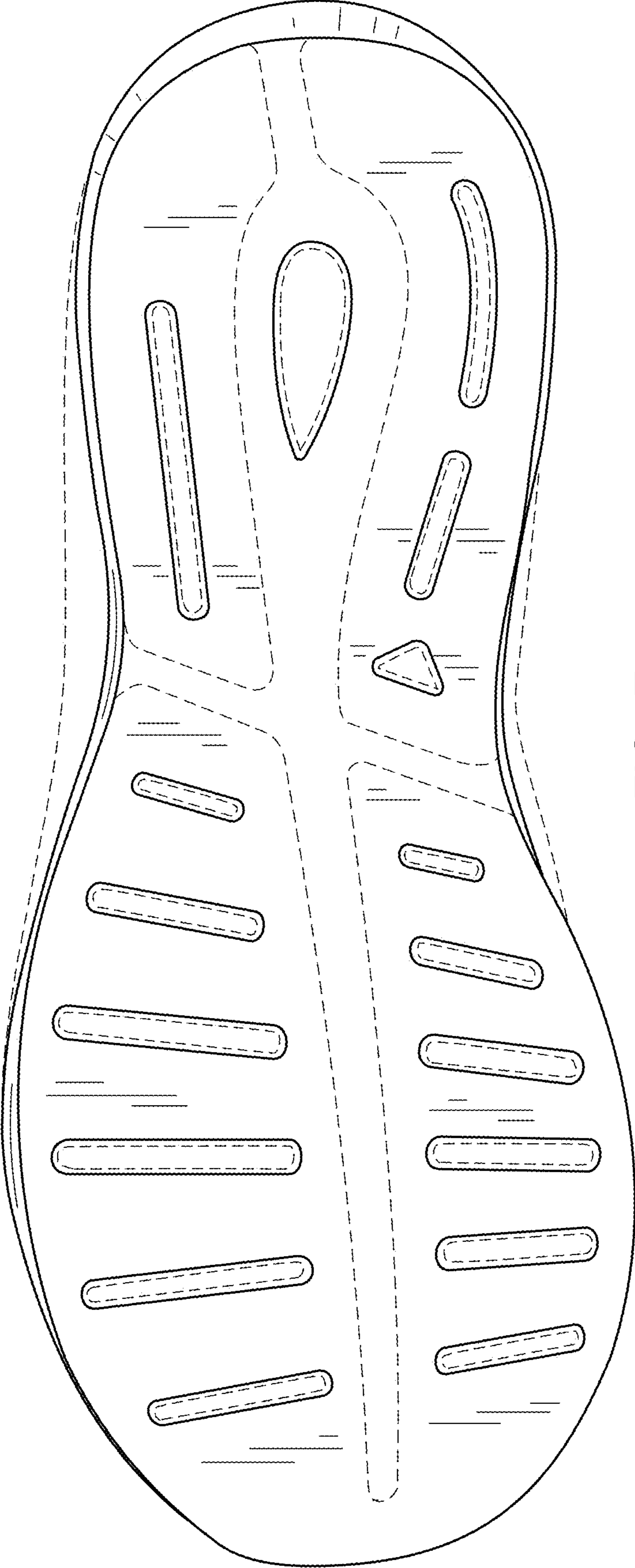

FIG. 7