



US00D943834S

(12) **United States Design Patent**  
**Siegieńczuk**

(10) **Patent No.:** **US D943,834 S**

(45) **Date of Patent:** **\*\* Feb. 15, 2022**

- (54) **TACTICAL VEST**
- (71) Applicant: **Helikon-Tex Grzegorz Mieszczak**,  
Wrocław (PL)
- (72) Inventor: **Piotr Siegieńczuk**, Wrocław (PL)
- (73) Assignee: **HELIKON-TEX GRZEGORZ**  
**MIESZCZAK**, Wrocław (PL)
- (\*\*) Term: **15 Years**
- (21) Appl. No.: **29/734,973**
- (22) Filed: **May 17, 2020**
- (51) **LOC (13) Cl.** ..... **02-02**
- (52) **U.S. Cl.**  
USPC ..... **D29/101.4**
- (58) **Field of Classification Search**  
USPC ..... D29/100–101.5; D2/828, 829, 830, 716,  
D2/728, 739, 759  
CPC ..... A41D 3/02; A41D 27/201; A41D 27/205;  
A41D 1/04; A41D 13/00; A41D 13/0012;  
A41D 13/0015; A41D 13/01; A41D  
13/0518; A41D 13/0568; A41D 13/0575;  
A41D 13/0593; A41D 13/005; A41D  
13/04; A41D 13/05; A61F 7/00; F41H  
1/02

See application file for complete search history.

(56) **References Cited**

**U.S. PATENT DOCUMENTS**

- 7,047,570 B2 \* 5/2006 Johnson ..... F41H 1/02  
2/102
- 7,424,748 B1 \* 9/2008 McDunn ..... F41H 5/013  
2/2.5
- D602,205 S \* 10/2009 Thomas ..... D29/101.4
- 7,979,917 B2 \* 7/2011 Osborne ..... F41H 1/02  
2/2.5
- 7,987,523 B2 \* 8/2011 Cole ..... A45F 5/00  
2/102

- 8,365,312 B2 \* 2/2013 Herring ..... F41H 1/02  
2/2.5
- 8,418,265 B1 \* 4/2013 Storms, Jr ..... F41H 1/02  
2/102
- 8,533,862 B2 \* 9/2013 Khandelwal ..... F41H 1/02  
2/2.5
- 8,608,041 B1 \* 12/2013 Adkisson ..... B32B 5/24  
224/651
- D767,824 S \* 9/2016 Hilliard ..... D29/100
- D777,378 S \* 1/2017 Tien ..... D29/101.4
- D802,885 S \* 11/2017 DeWeever ..... D2/829
- 9,851,181 B2 \* 12/2017 Beck ..... A41D 1/04
- D808,594 S \* 1/2018 Tien ..... D29/101.4
- 10,051,984 B2 \* 8/2018 Buerck ..... A47G 25/90
- 10,231,533 B2 \* 3/2019 Vaughan ..... A45F 3/06
- 10,281,240 B2 \* 5/2019 Cole ..... F41H 1/02
- D854,251 S \* 7/2019 Swan ..... D29/101.4
- 10,466,015 B2 \* 11/2019 Richardson ..... F41H 5/013
- D873,494 S \* 1/2020 Preisinger ..... D29/101.4
- D880,073 S \* 3/2020 Groat ..... D29/101.4
- 10,605,574 B2 \* 3/2020 Swan ..... A45F 3/06

(Continued)

*Primary Examiner* — Kimberly Barnes

(74) *Attorney, Agent, or Firm* — Andrzej Malarz, Esq.

(57) **CLAIM**

The ornamental design for a tactical vest, as shown and described.

**DESCRIPTION**

FIG. 1 is a front elevational view of a tactical vest showing my new design;  
 FIG. 2 is a rear elevational view thereof;  
 FIG. 3 is a right side elevational view thereof;  
 FIG. 4 is a left side elevational view thereof;  
 FIG. 5 is a top plan view thereof;  
 FIG. 6 is a bottom plan view thereof;  
 FIG. 7 is a front, left side perspective view thereof; and,  
 FIG. 8 is a rear left side perspective view thereof.  
 The broken lines in the drawings depict stitching that forms no part of the claimed design.

**1 Claim, 8 Drawing Sheets**

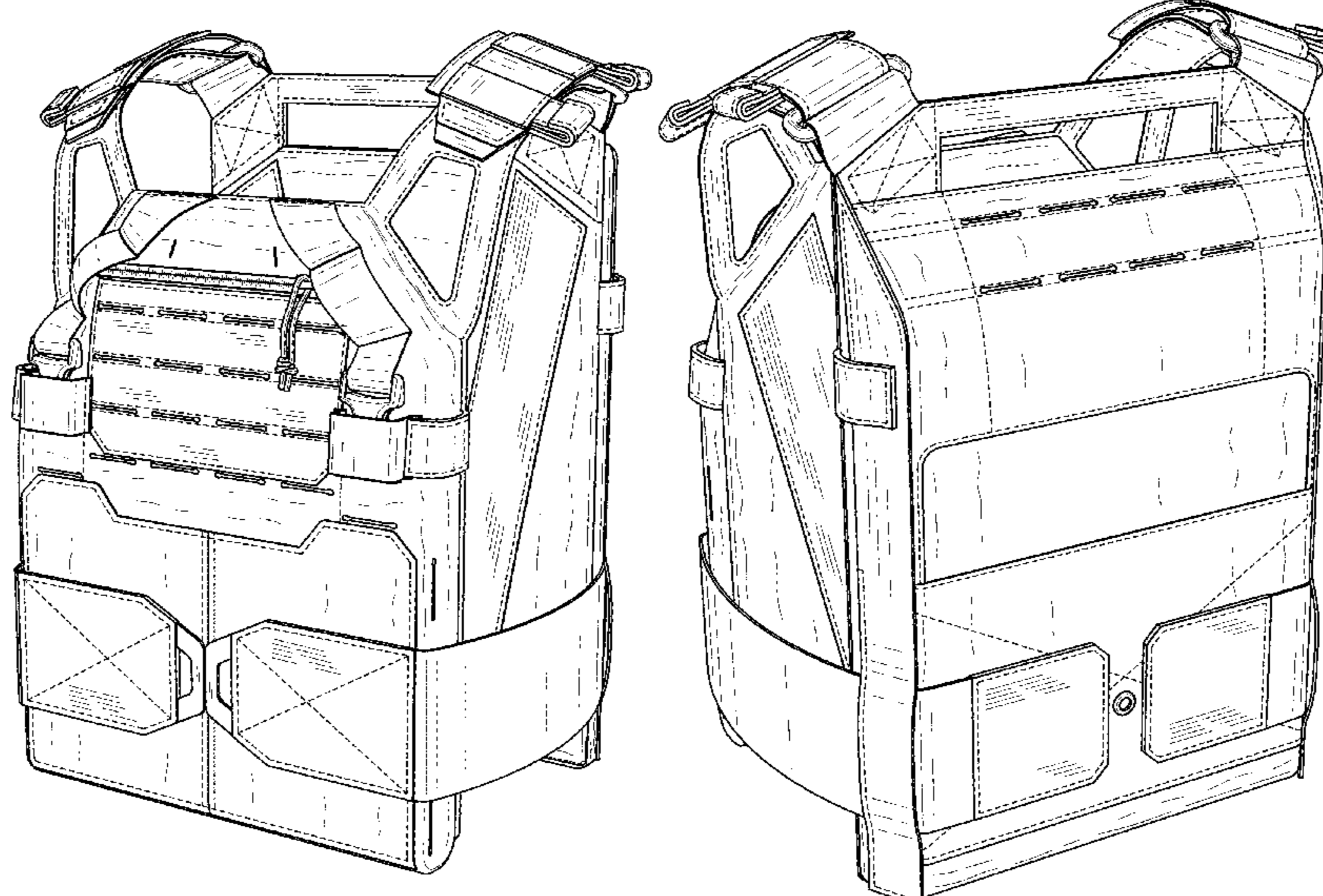

(56)

**References Cited**

U.S. PATENT DOCUMENTS

10,616,534	B2 *	4/2020	Thiel .....	A41D 13/0012
10,788,293	B2 *	9/2020	Beck .....	F41H 5/0478
2012/0084906	A1 *	4/2012	Sego, Jr .....	F41H 1/02 2/463
2012/0132066	A1 *	5/2012	Seuk .....	F41H 1/02 89/36.05
2012/0180178	A1 *	7/2012	Gallo .....	F41H 1/02 2/2.5

\* cited by examiner

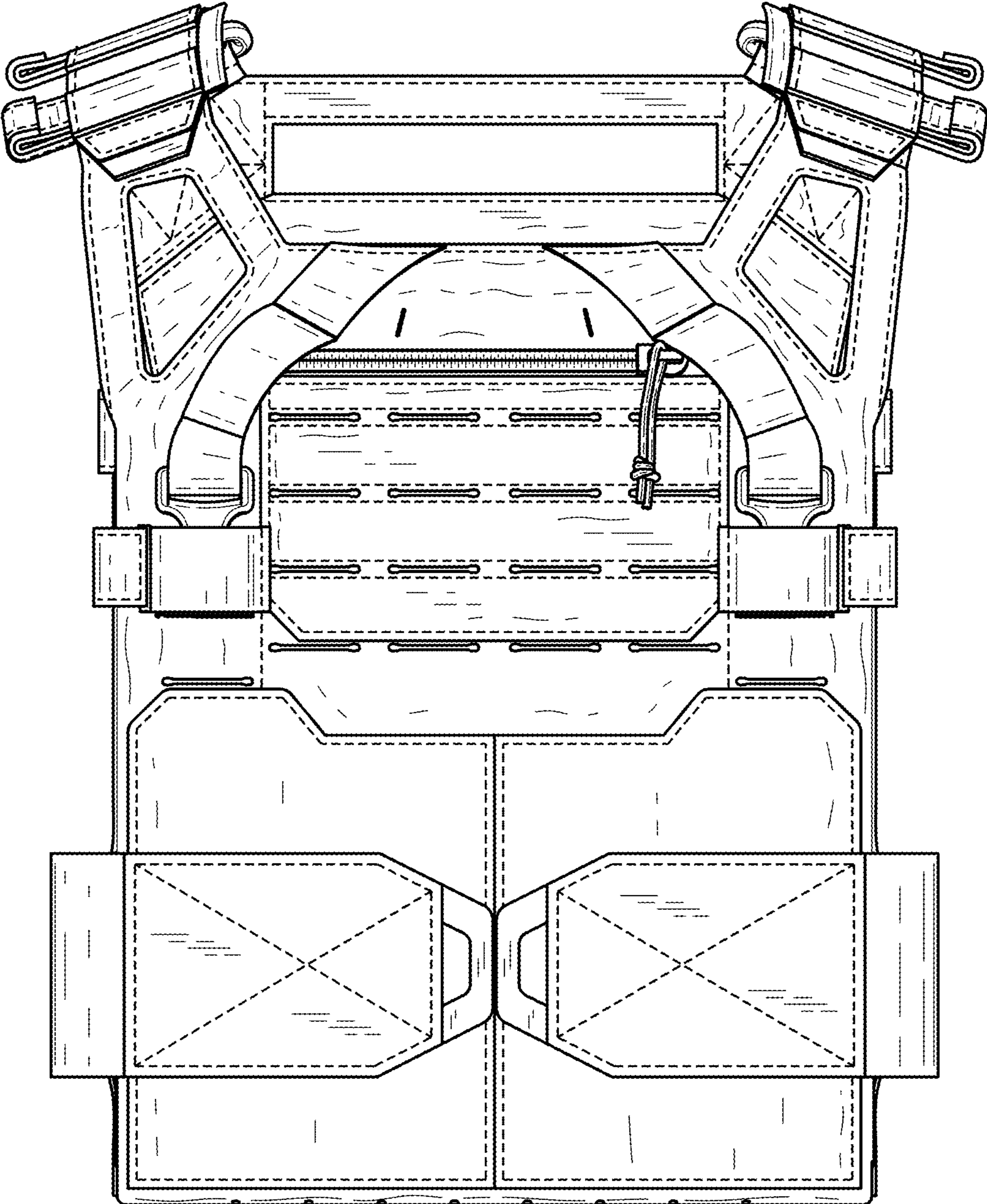

FIG.1

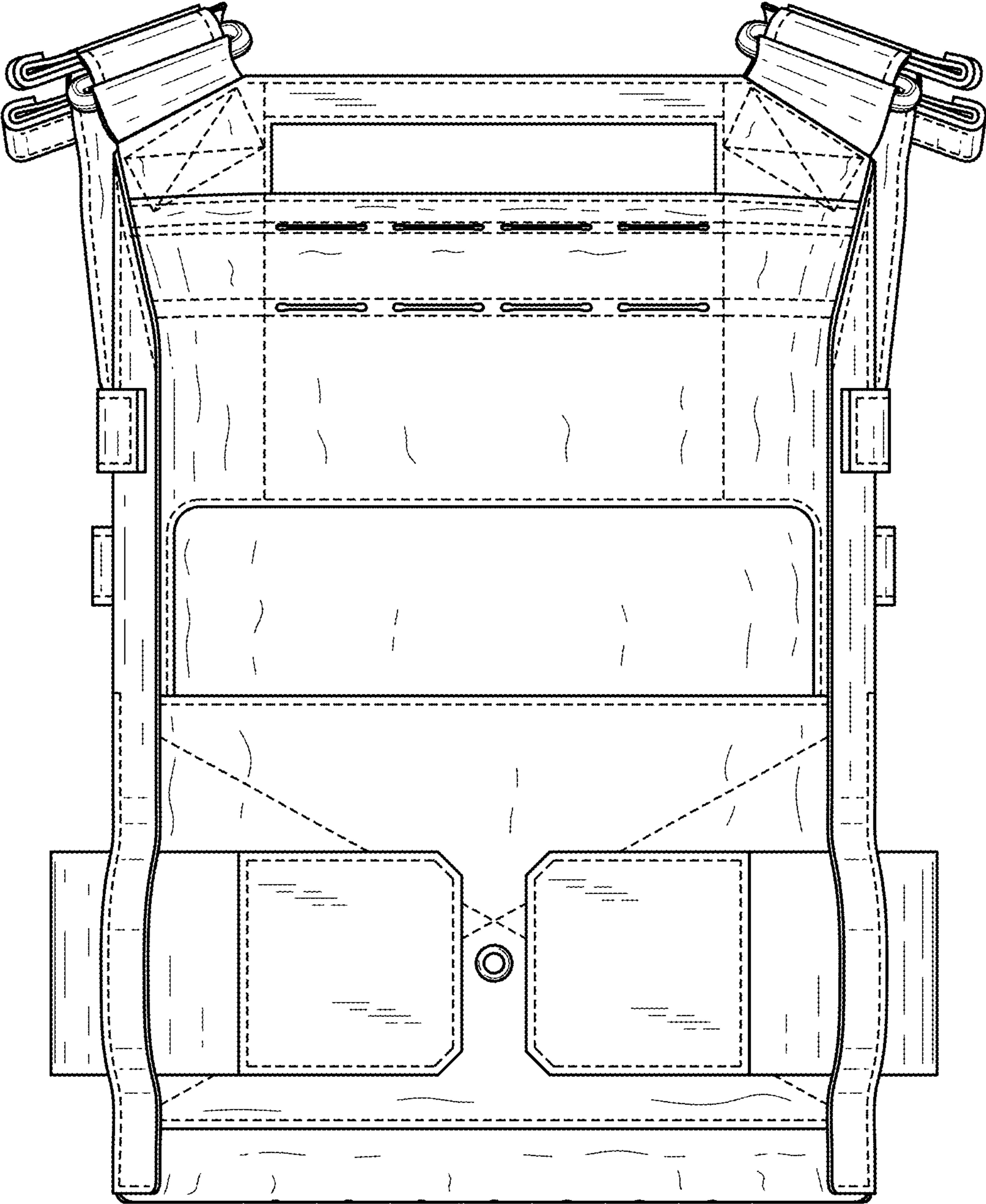

FIG.2

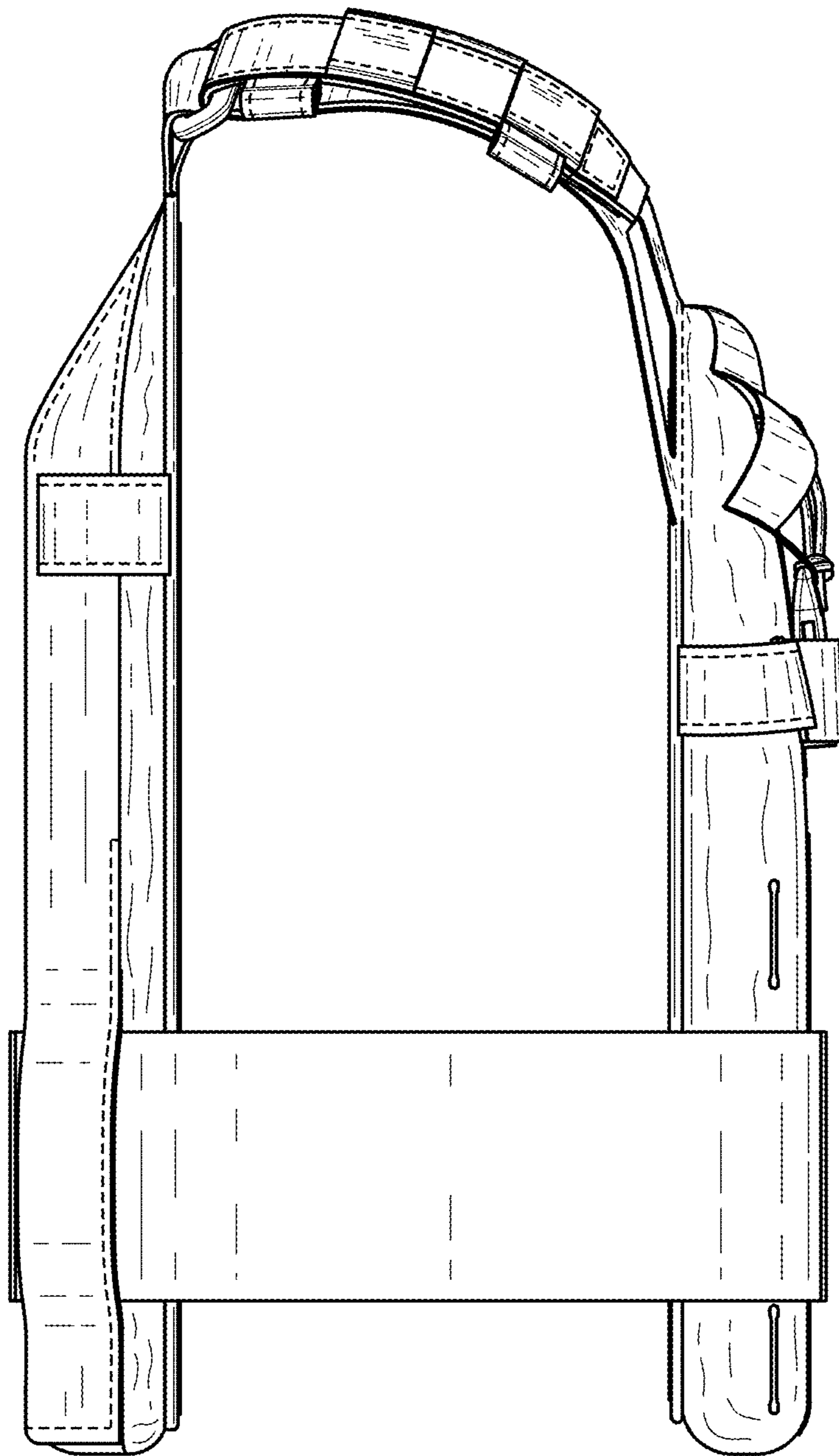

FIG.3

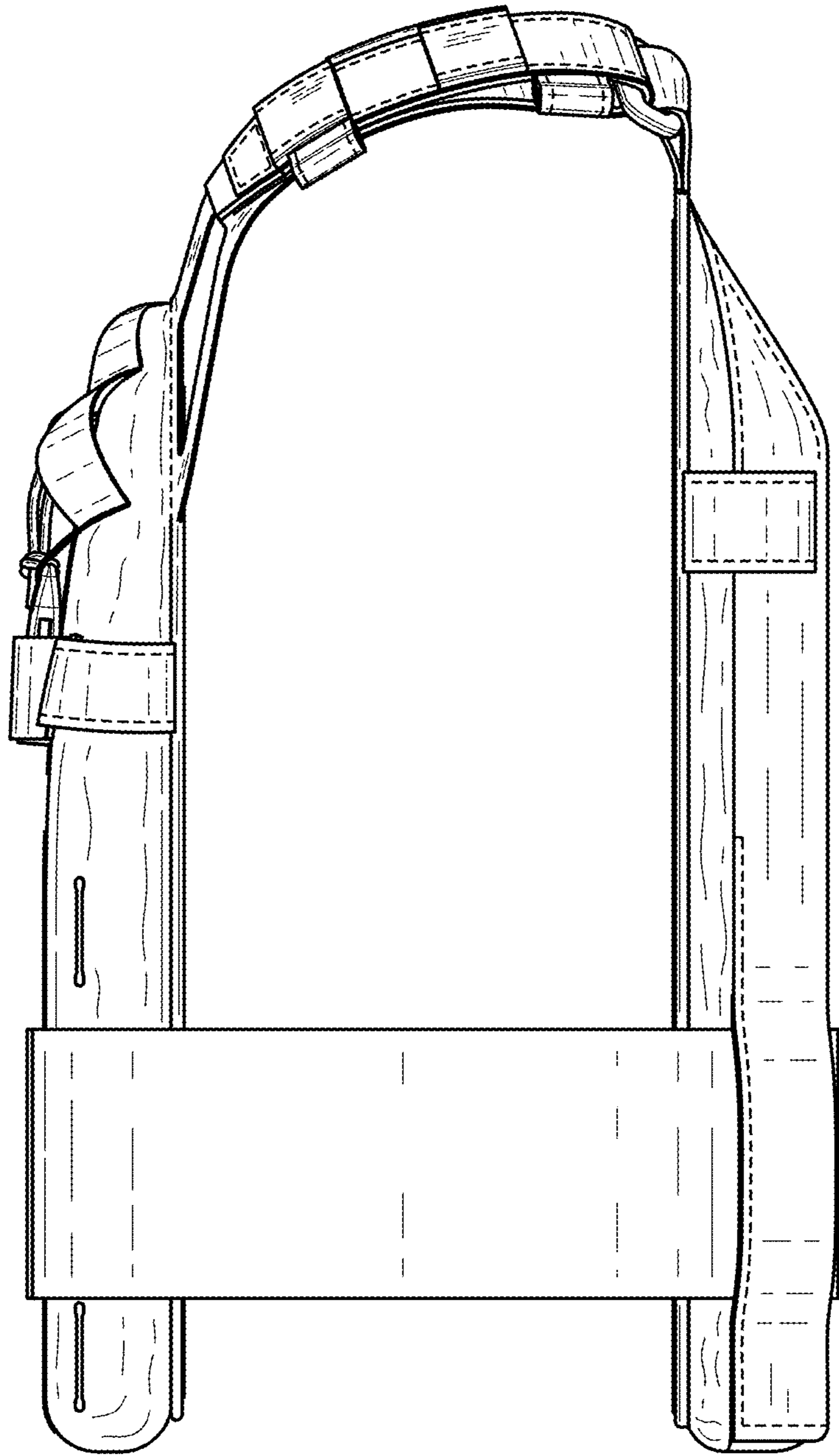

FIG.4

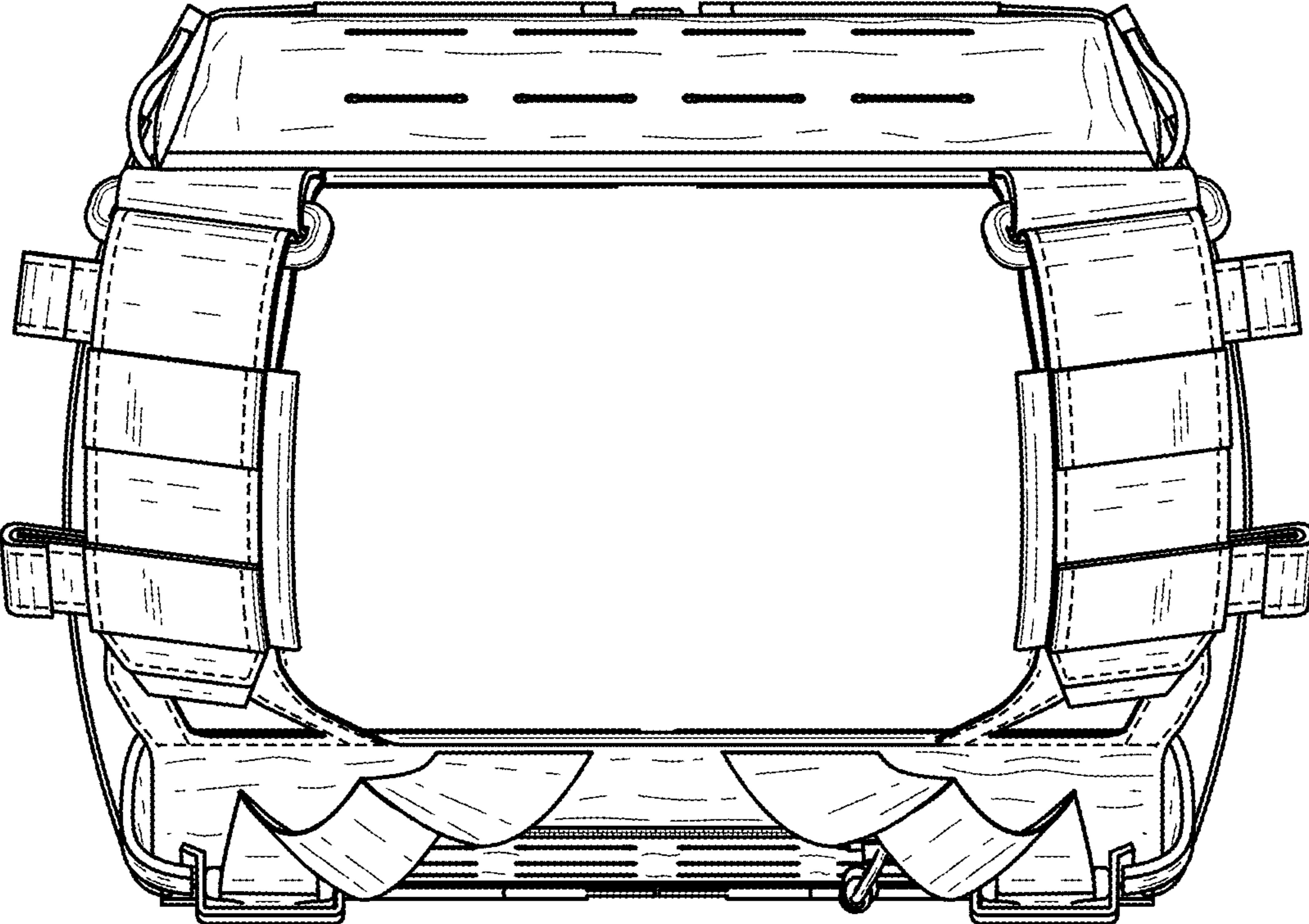

FIG.5

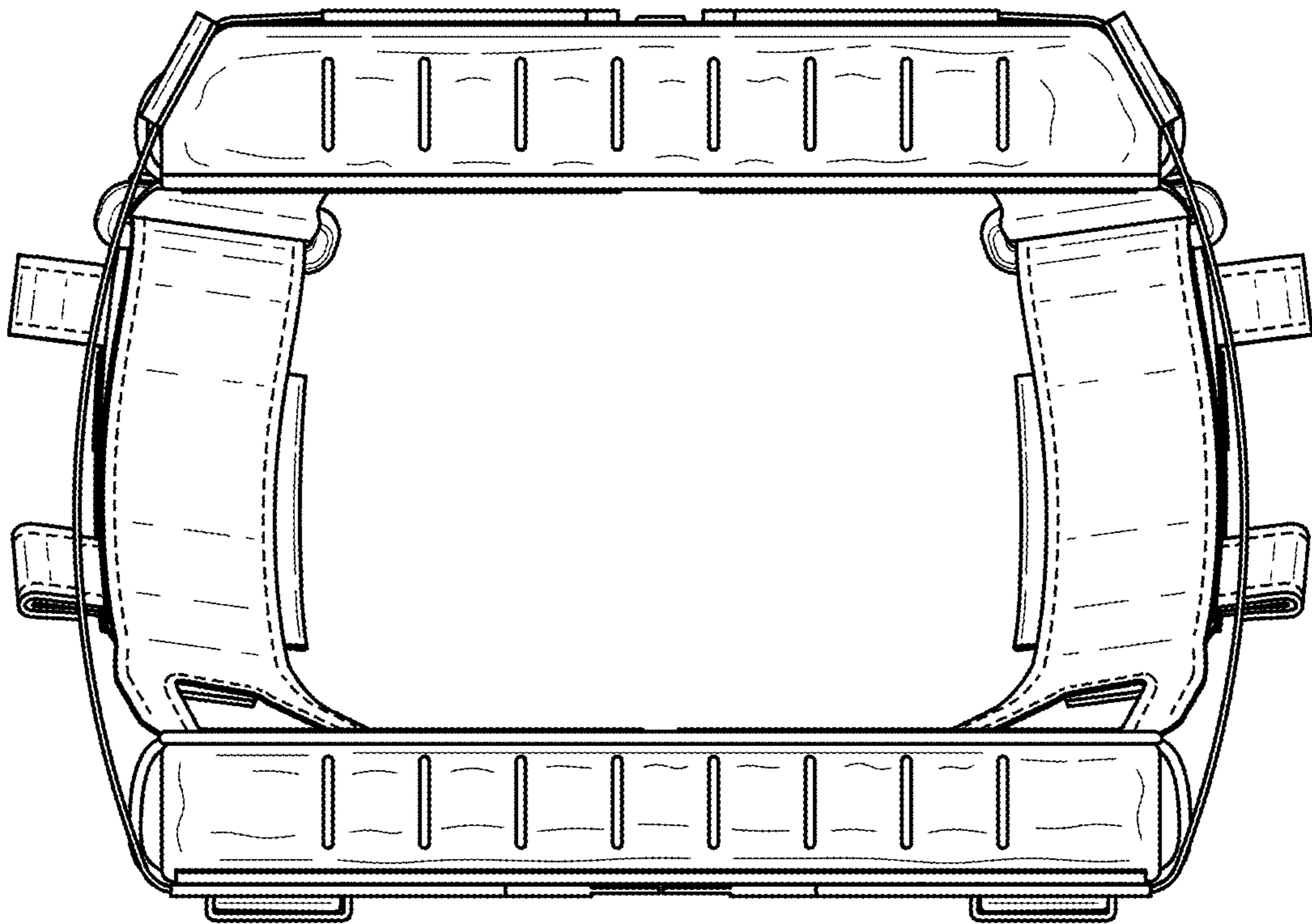

FIG.6



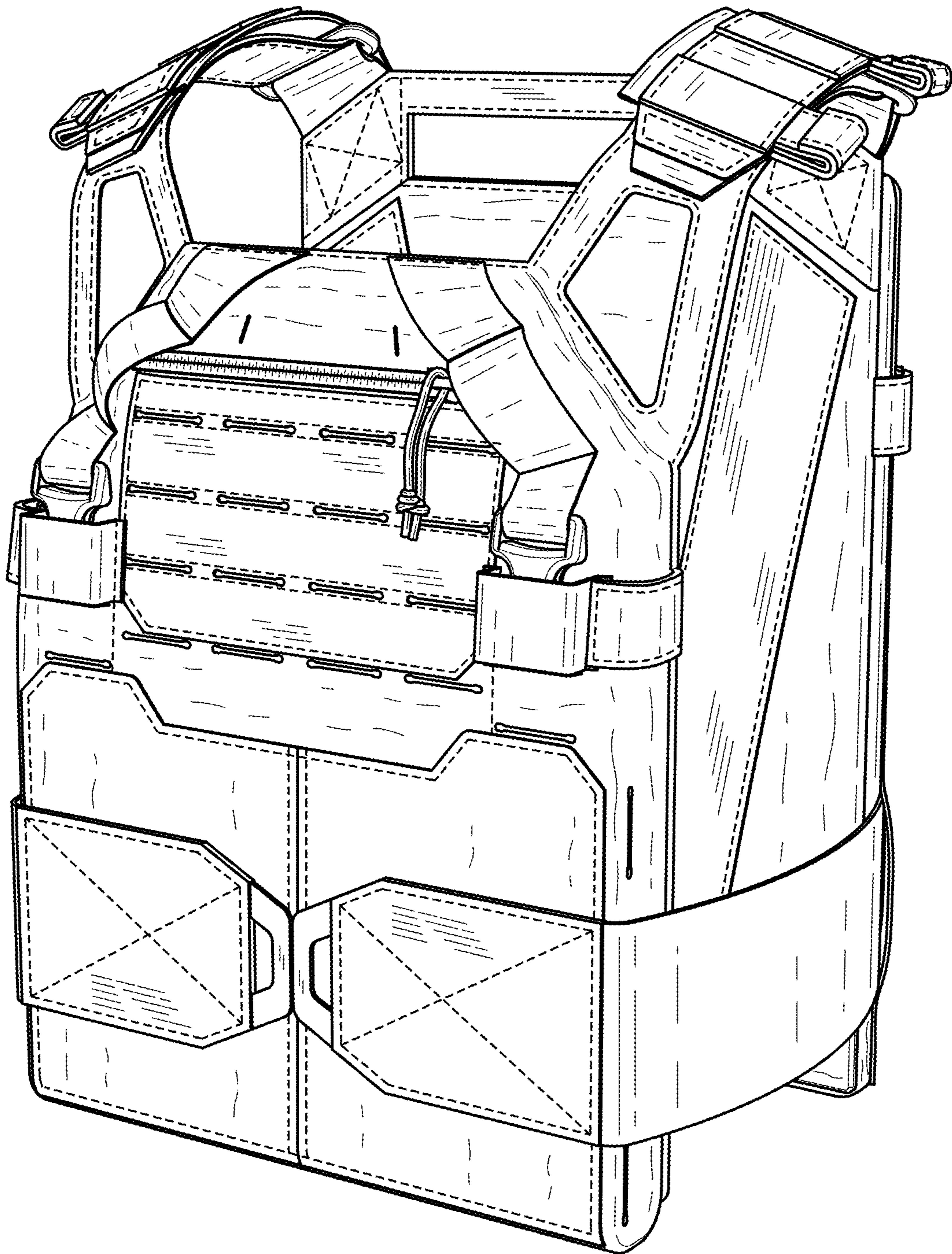

FIG.7

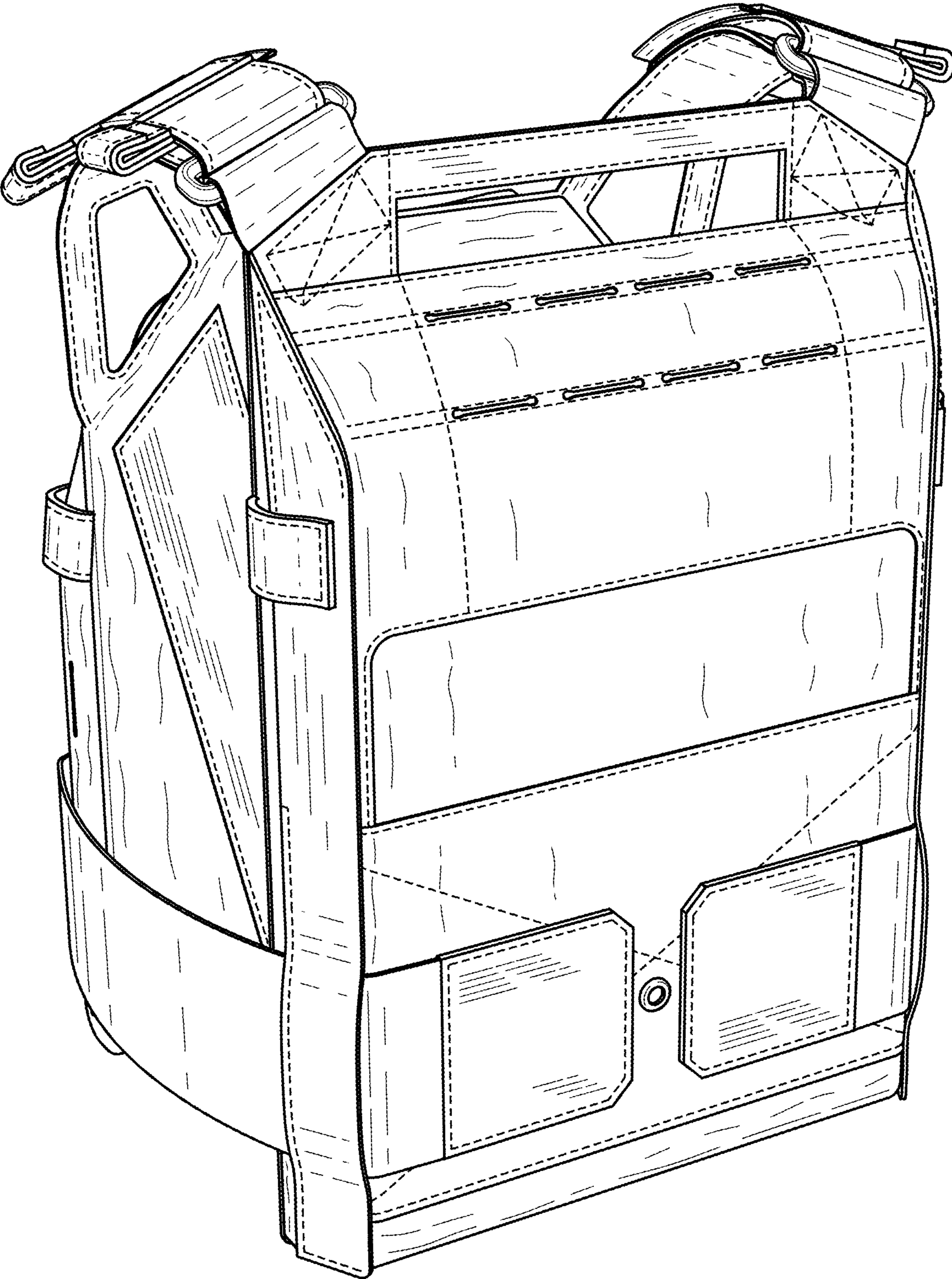

FIG.8