

US00D943755S

(12) **United States Design Patent**
Bouma

(10) **Patent No.:** **US D943,755 S**
(45) **Date of Patent:** **** Feb. 15, 2022**

- (54) **ORTHOSIS**
- (71) Applicant: **Invent Medical Group, s.r.o.**, Ostrava (CZ)
- (72) Inventor: **Tomáš Bouma**, Ostrava (CZ)
- (73) Assignee: **Invent Medical Group, s.r.o.**, Ostrava (CZ)
- (**) Term: **15 Years**
- (21) Appl. No.: **29/743,074**
- (22) Filed: **Jul. 17, 2020**

D639,965 S *	6/2011	Wehsely-Swiczinsky	D24/192
8,002,724 B2 *	8/2011	Hu	A61F 5/0127 602/27
D682,434 S *	5/2013	Heyd	D24/192
D696,409 S *	12/2013	Best	D24/192
D718,024 S *	11/2014	Wells	D2/943
8,986,235 B2 *	3/2015	Weaver, II	A61F 5/0111 602/65
D737,454 S *	8/2015	Wen	D24/192
D759,255 S *	6/2016	Bradley	D24/192
9,561,128 B2 *	2/2017	Joseph	A61F 5/01
10,092,435 B2 *	10/2018	Heyd	A61F 5/0102
D927,707 S *	8/2021	Kim	D24/192

* cited by examiner

Primary Examiner — Jennifer L Watkins
(74) *Attorney, Agent, or Firm* — Kilpatrick Townsend & Stockton LLP

Related U.S. Application Data

- (63) Continuation of application No. 29/741,419, filed on Jul. 13, 2020.
- (51) **LOC (13) Cl.** **24-01**
- (52) **U.S. Cl.**
USPC **D24/192**
- (58) **Field of Classification Search**
USPC D24/190–192; D29/121.1, 121.2
See application file for complete search history.

References Cited

U.S. PATENT DOCUMENTS

D272,281 S *	1/1984	Alush	D24/192
D583,956 S *	12/2008	Chang	D24/192

(57) **CLAIM**

The ornamental design for an orthosis, as shown and described.

DESCRIPTION

FIG. 1 is a side view of an orthosis.
FIG. 2 is another side view of the orthosis of FIG. 1.
FIG. 3 is an isometric view of the orthosis of FIG. 1.
FIG. 4 is a top view of the orthosis of FIG. 1.
FIG. 5 is a front view of the orthosis of FIG. 1; and,
FIG. 6 is a back view of the orthosis of FIG. 1.

1 Claim, 6 Drawing Sheets

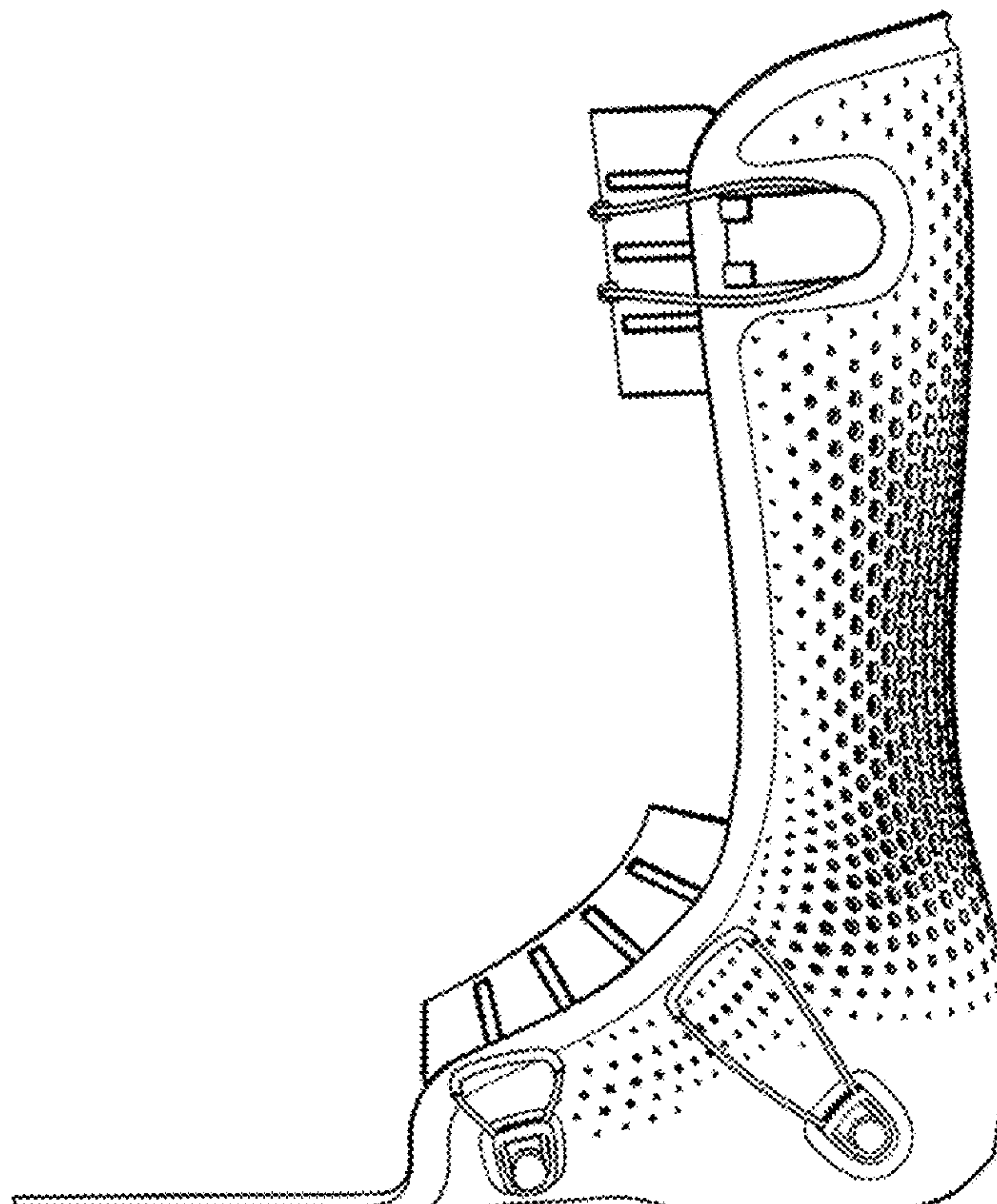

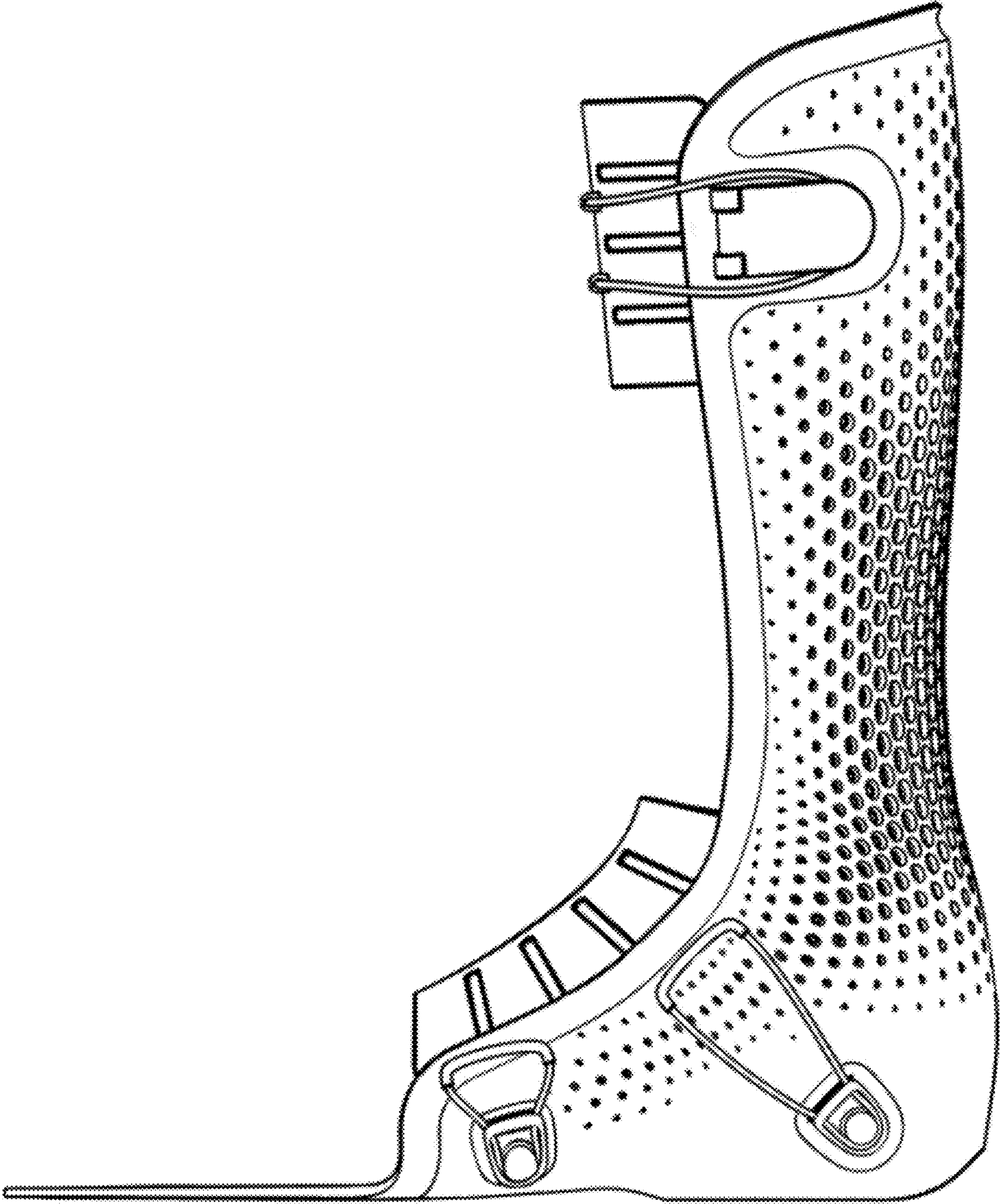

Figure 1

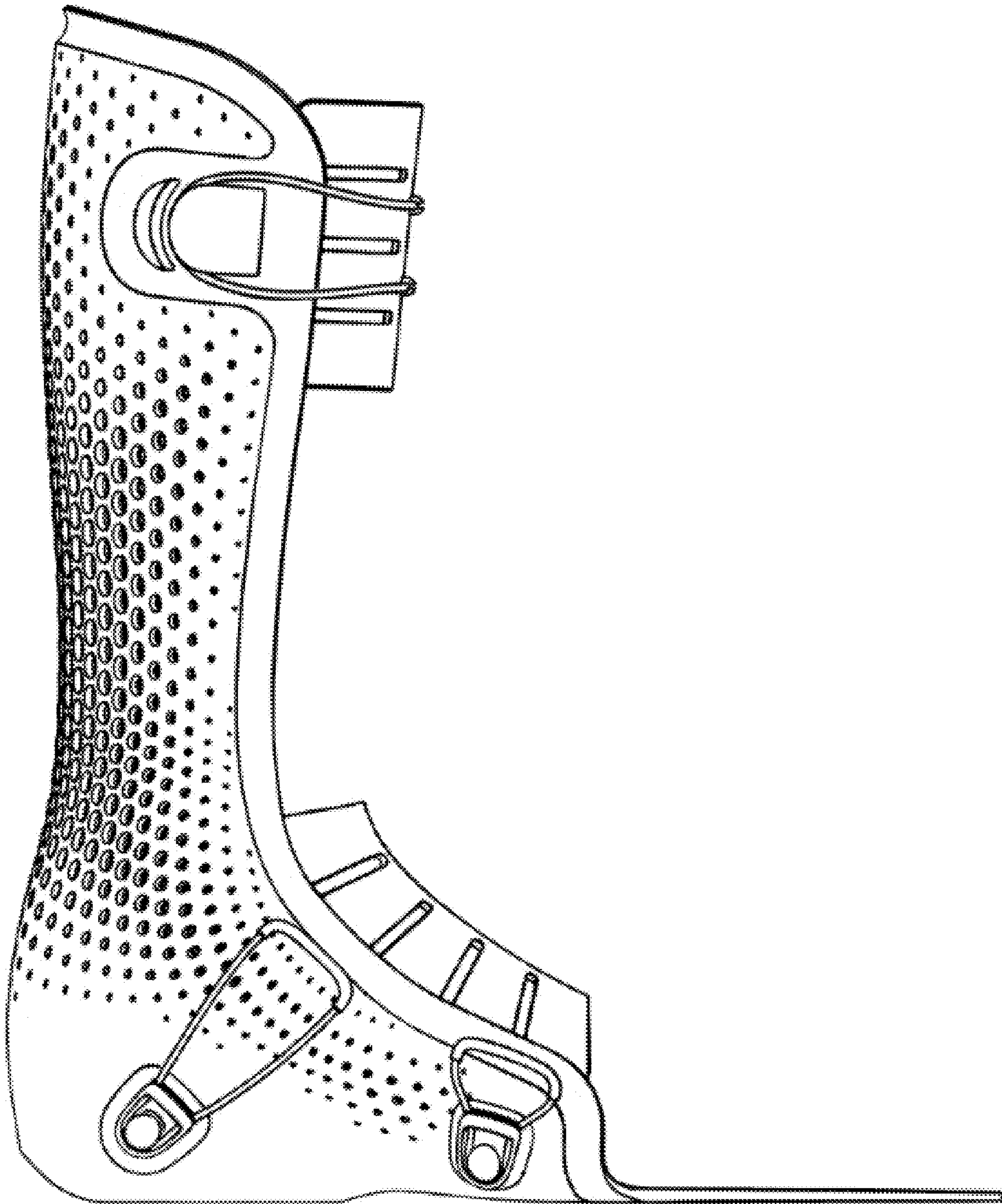

Figure 2

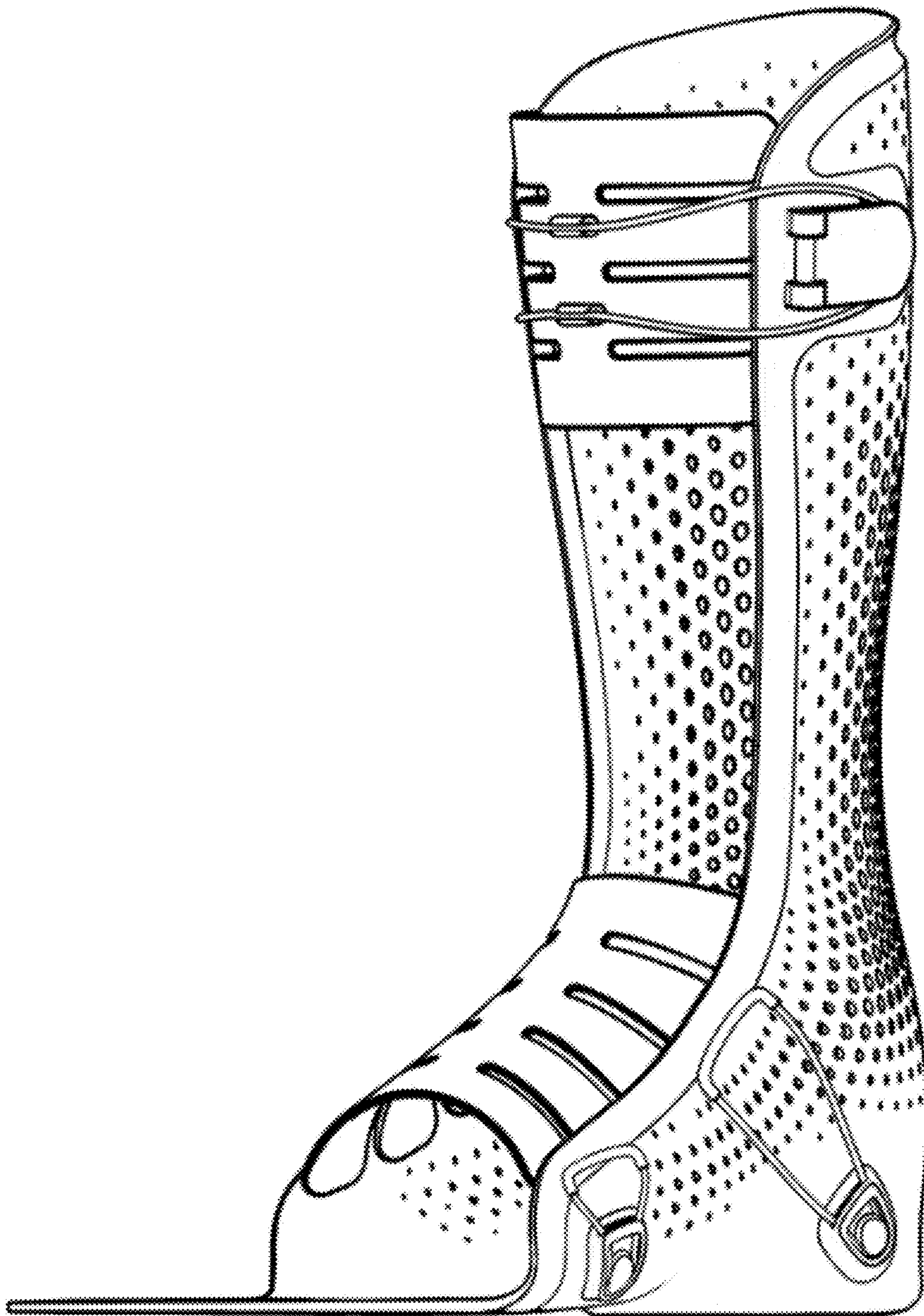

Figure 3

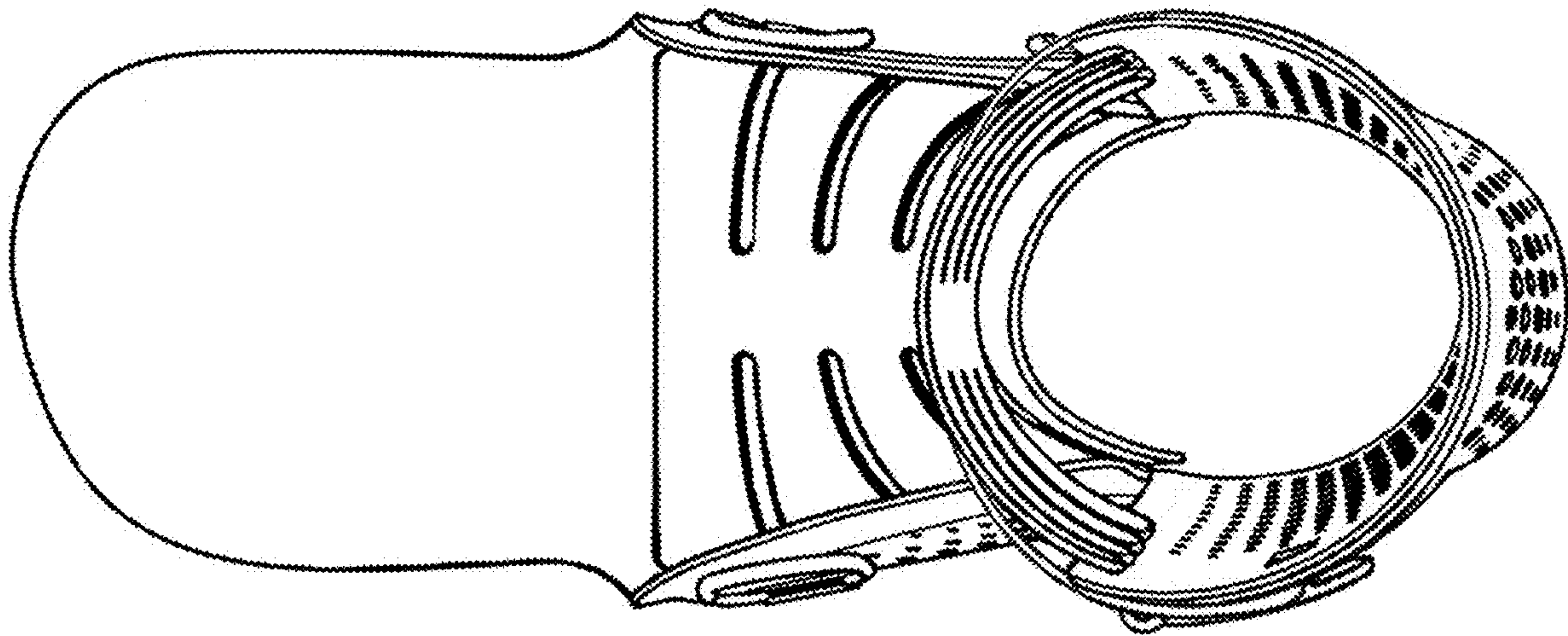

Figure 4

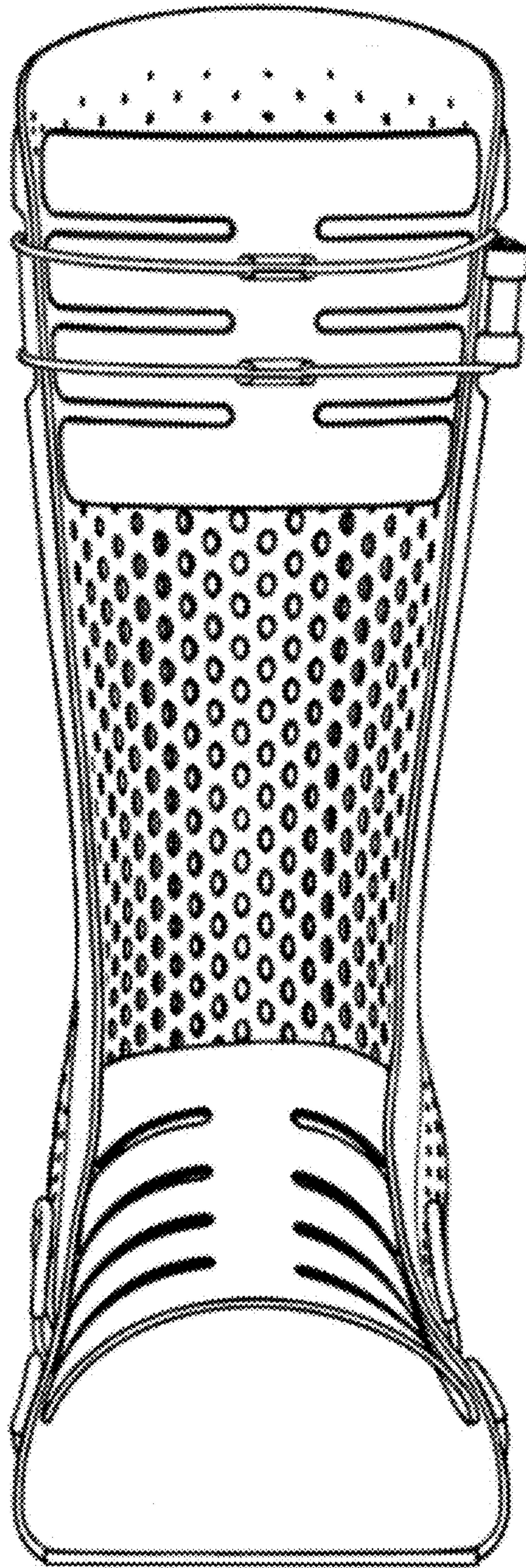

Figure 5

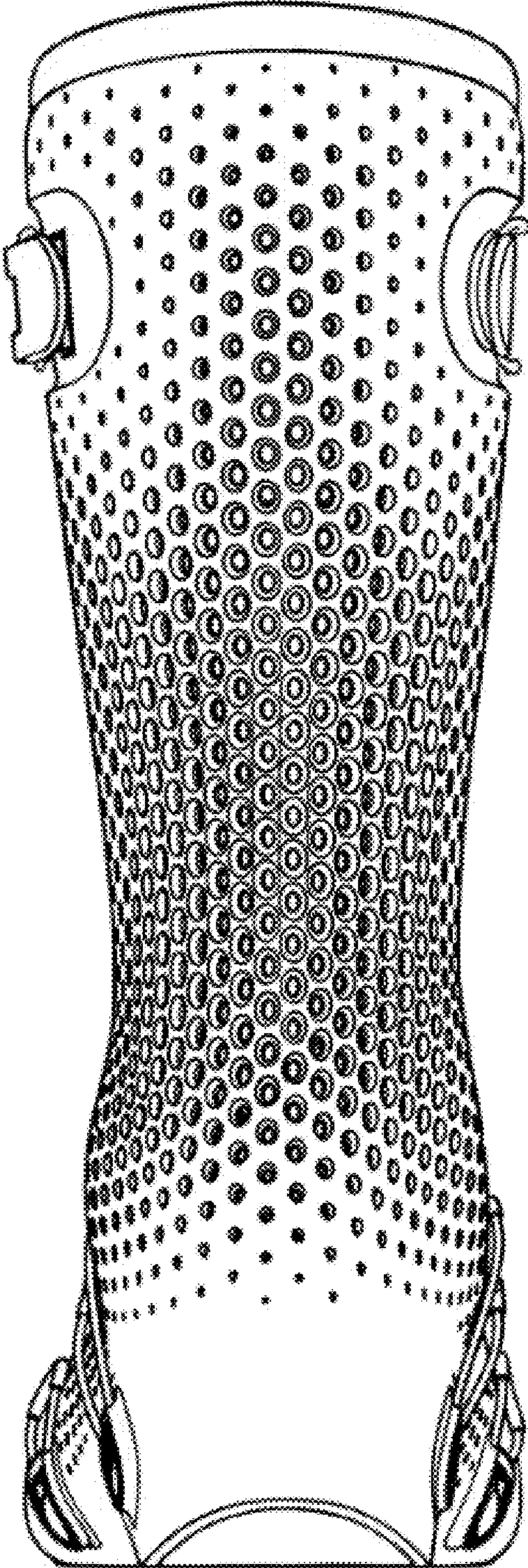

Figure 6