



US00D943738S

(12) **United States Design Patent** (10) **Patent No.:** **US D943,738 S**
Lee et al. (45) **Date of Patent:** **** Feb. 15, 2022**

(54) **BEDPAN HOUSING**

(71) Applicants: **Jordan Muen Lee**, Newton, MA (US);
Michael Andrew Morgan, Cincinnati,
OH (US)

(72) Inventors: **Jordan Muen Lee**, Newton, MA (US);
Michael Andrew Morgan, Cincinnati,
OH (US)

(**) Term: **15 Years**

(21) Appl. No.: **29/719,826**

(22) Filed: **Jan. 8, 2020**

(51) **LOC (13) Cl.** **24-04**

(52) **U.S. Cl.**
USPC **D24/123**

(58) **Field of Classification Search**
USPC D24/120–123, 108, 127, 128; D9/455;
D23/295–297, 303, 309
CPC A61G 9/00; A61G 9/003; A61G 9/006
See application file for complete search history.

(56) **References Cited**

U.S. PATENT DOCUMENTS

| | | | | |
|-----------|-----|---------|--------------|---------|
| 1,445,836 | A | 2/1923 | Kowalsky | |
| 1,542,920 | A | 6/1925 | Swenson | |
| 1,872,809 | A | 8/1932 | Randall | |
| 1,918,083 | A | 7/1933 | Case et al. | |
| 3,061,840 | A | 11/1962 | Presseisen | |
| 3,462,770 | A | 8/1969 | Smith | |
| D245,922 | S * | 9/1977 | Mills | D24/123 |
| D248,408 | S * | 7/1978 | Mills | D24/123 |
| 4,233,691 | A | 11/1980 | Jirard | |
| D353,000 | S * | 11/1994 | Bradley, Jr. | D24/123 |
| 6,000,078 | A | 12/1999 | Stefano | |
| 6,532,605 | B1 | 3/2003 | Howell | |
| 6,725,485 | B2 | 4/2004 | Hayes | |
| 8,510,881 | B1 | 8/2013 | Lee | |
| D760,879 | S * | 7/2016 | McNair, Jr. | D23/311 |
| D866,754 | S * | 11/2019 | Jerichau | D24/123 |

2005/0177934 A1 8/2005 Host
2011/0185489 A1 8/2011 Partington et al.
2019/0021928 A1* 1/2019 Lee A61G 9/003
(Continued)

FOREIGN PATENT DOCUMENTS

BE 452896 11/1947
EM 007968151-0001 * 5/2020
(Continued)

OTHER PUBLICATIONS

The Bedderpan—a Truly Bedder Bedpan by Bedderpan. Amazon. Oldest review date: Mar. 5, 2021. Retrieval date: Jul. 29, 2021. Retrieved from internet: <https://www.amazon.com/Bedderpan-Truly-Bedder-Bedpan/dp/B08WCMGVBT/> (Year: 2021).*

Primary Examiner — Lilyana Bekic
Assistant Examiner — Lee D. Starr

(74) *Attorney, Agent, or Firm* — Lambert Shortell & Connaughton; David J. Connaughton, Jr.; Justin P. Tinger

(57) **CLAIM**

The ornamental design for the bedpan housing, as shown and described.

DESCRIPTION

FIG. 1 is a perspective front view of the bedpan housing, showing our new design;
FIG. 2 is a perspective bottom view thereof;
FIG. 3 is a top view thereof;
FIG. 4 is a bottom view thereof;
FIG. 5 is a rear view thereof;
FIG. 6 is a front view thereof;
FIG. 7 is a left side view thereof; and,
FIG. 8 is a right side view thereof.
The broken lines in the figures depict portions of the bedpan housing that form no part of the claimed design.

1 Claim, 6 Drawing Sheets

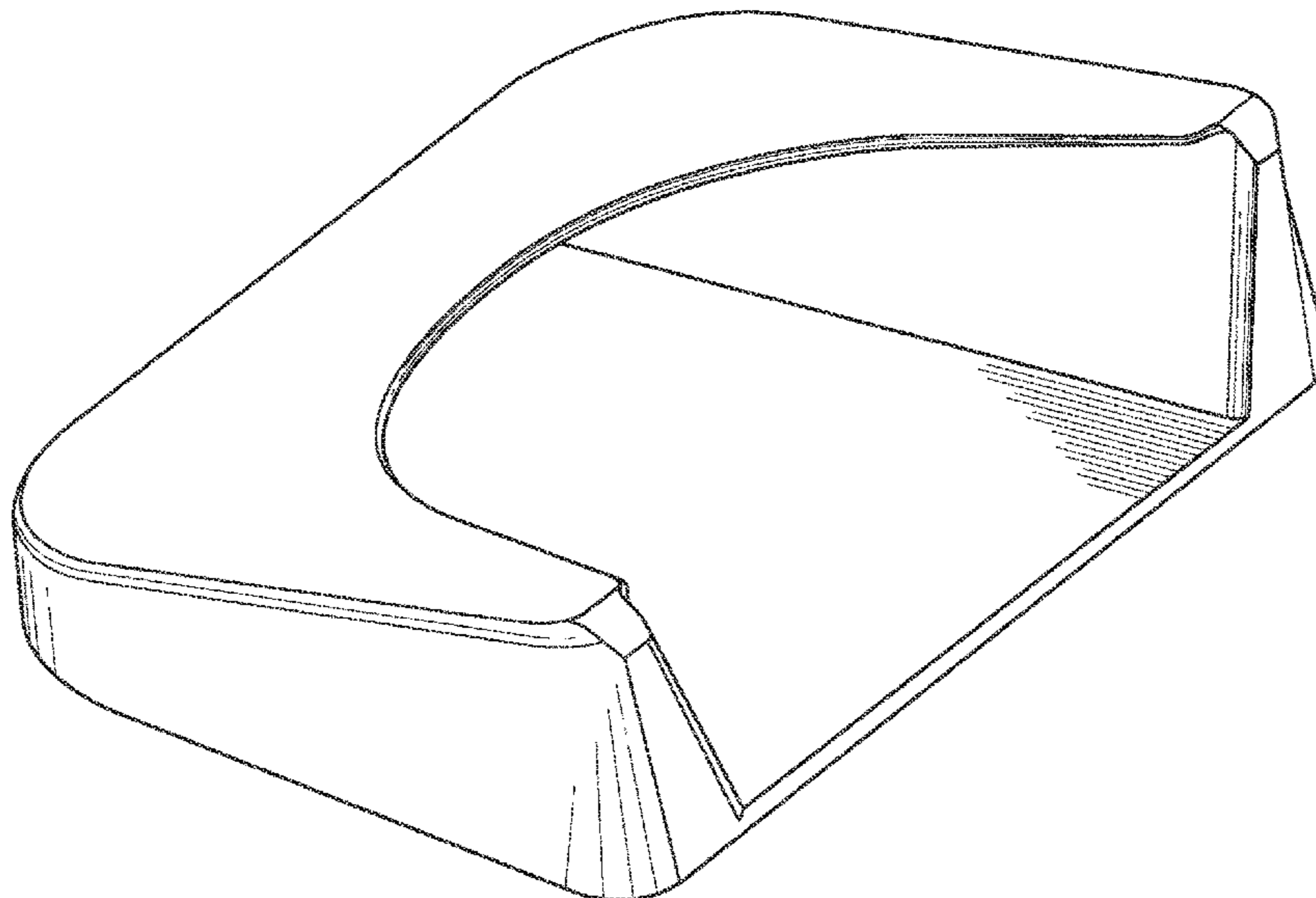

(56)

References Cited

U.S. PATENT DOCUMENTS

2019/0142675 A1* 5/2019 Lee A61G 9/003
4/457

FOREIGN PATENT DOCUMENTS

FR 2736541 6/1995
WO 2017156140 9/2017

* cited by examiner

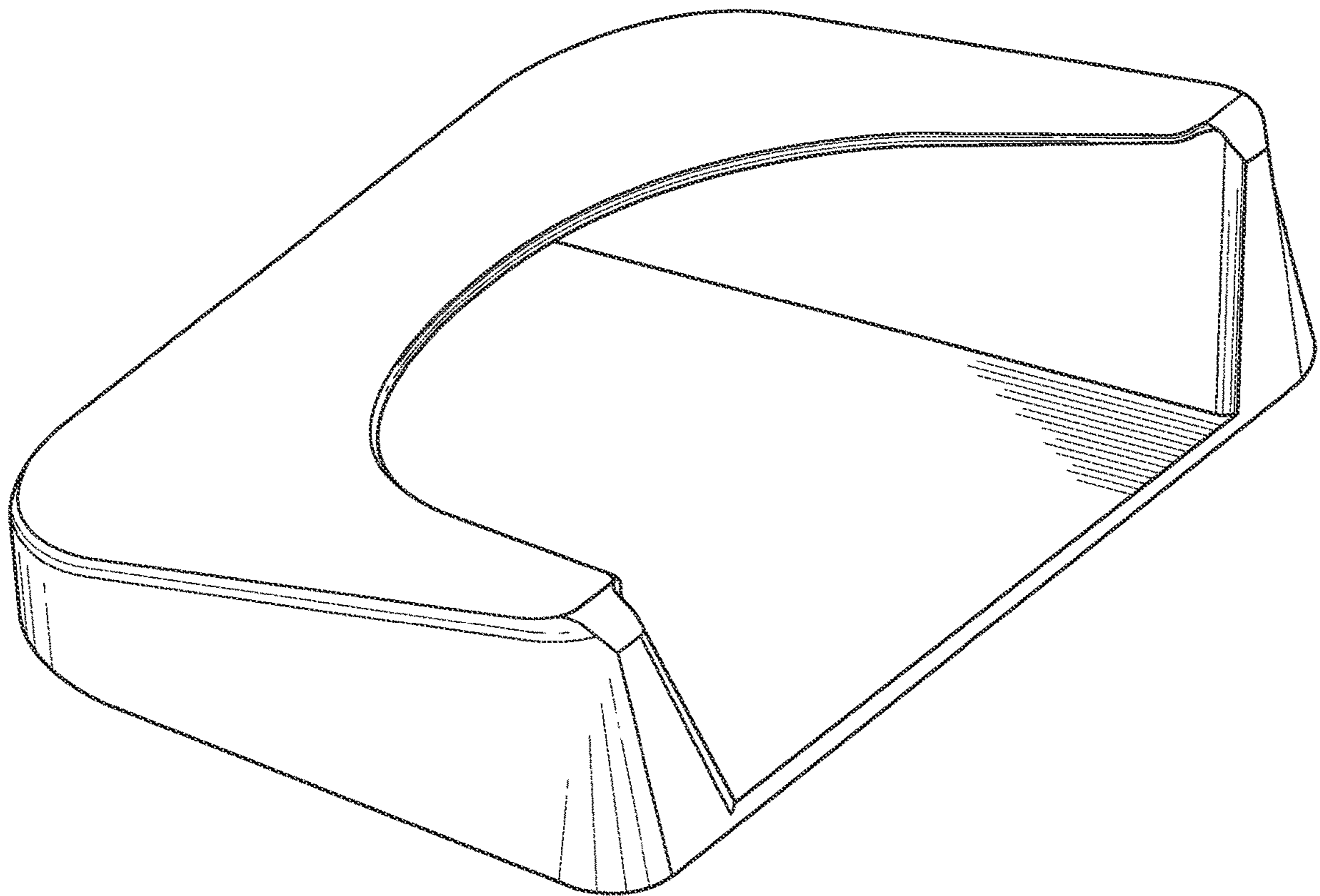

Fig. 1

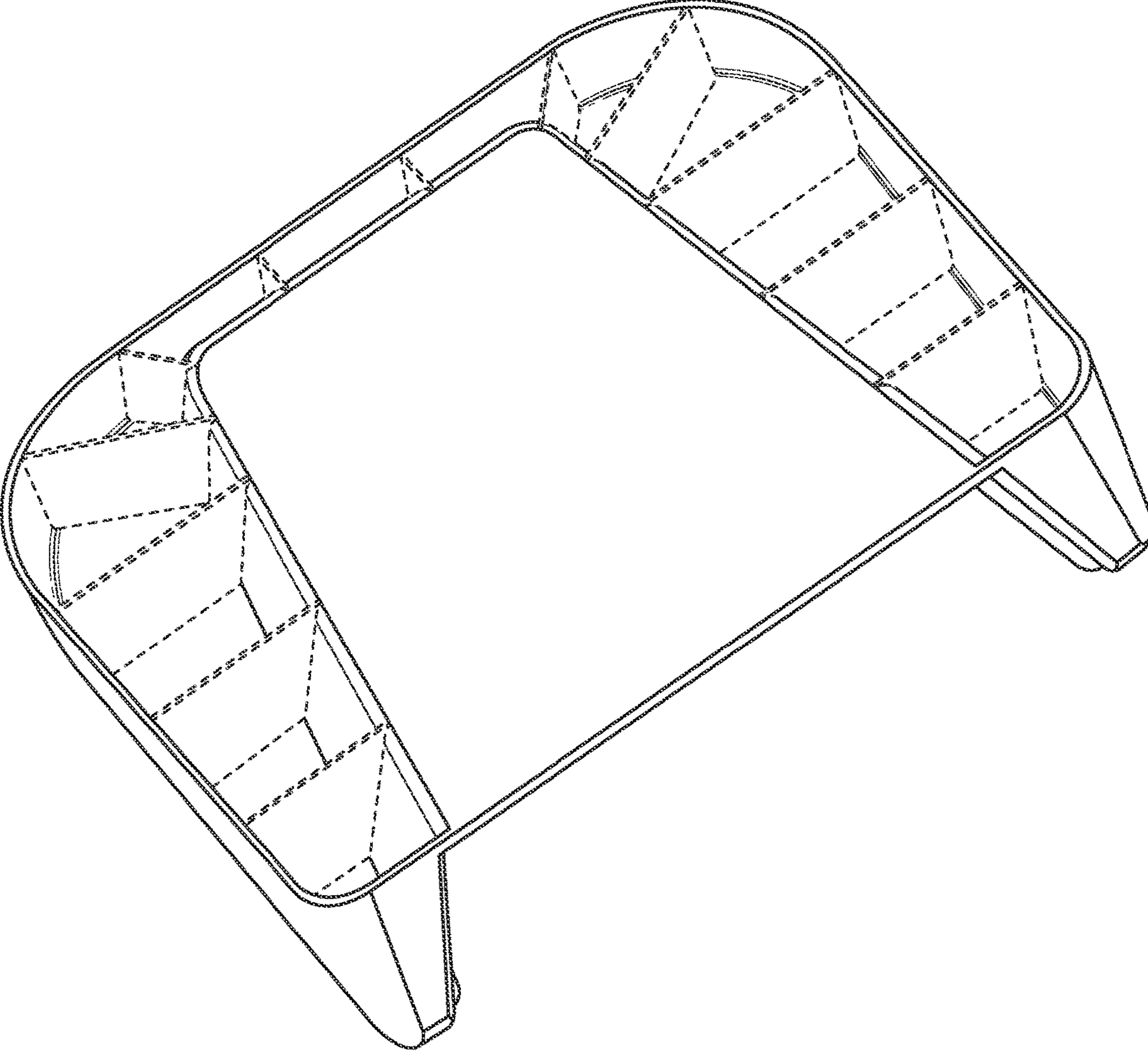

Fig. 2

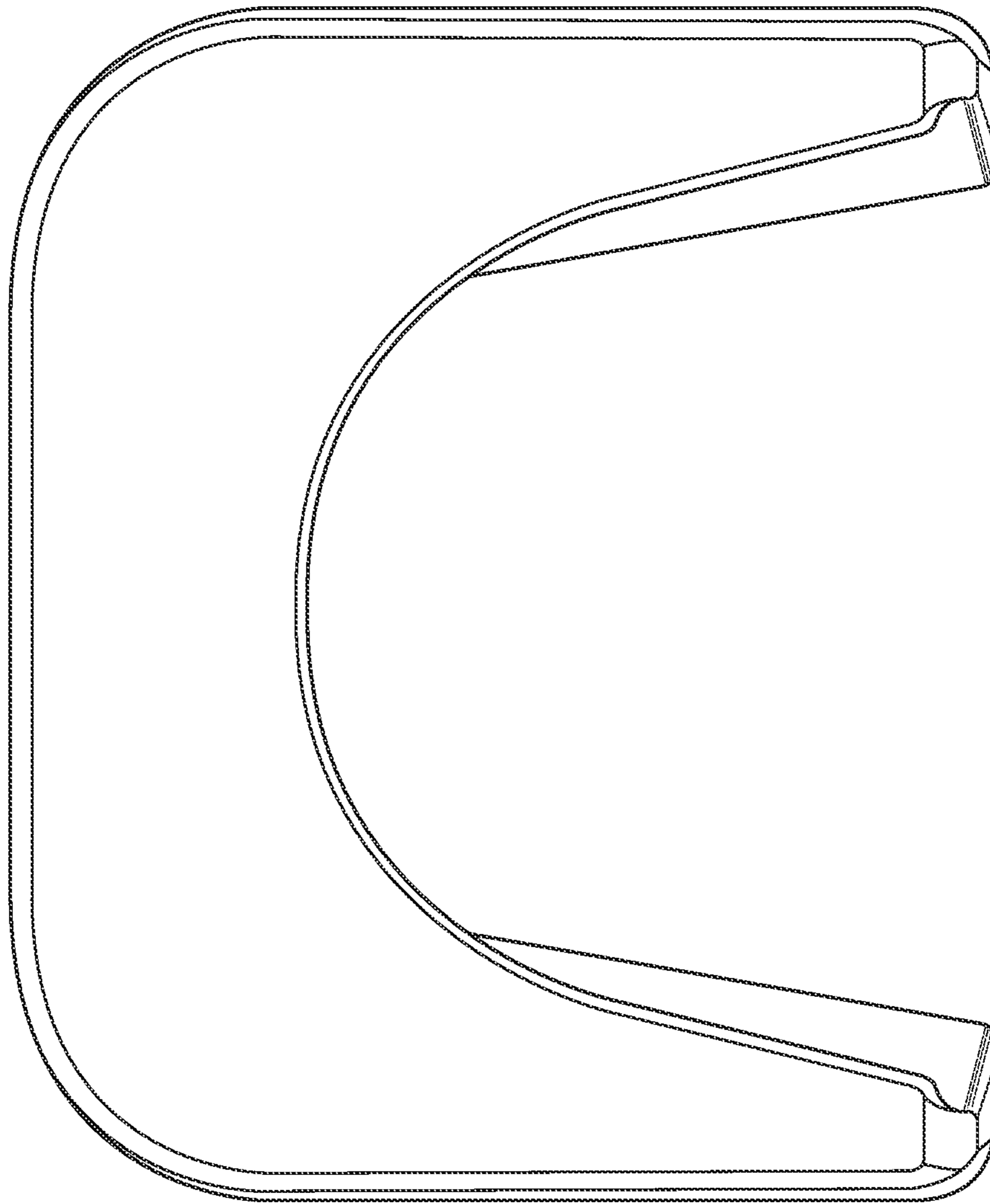

Fig. 3

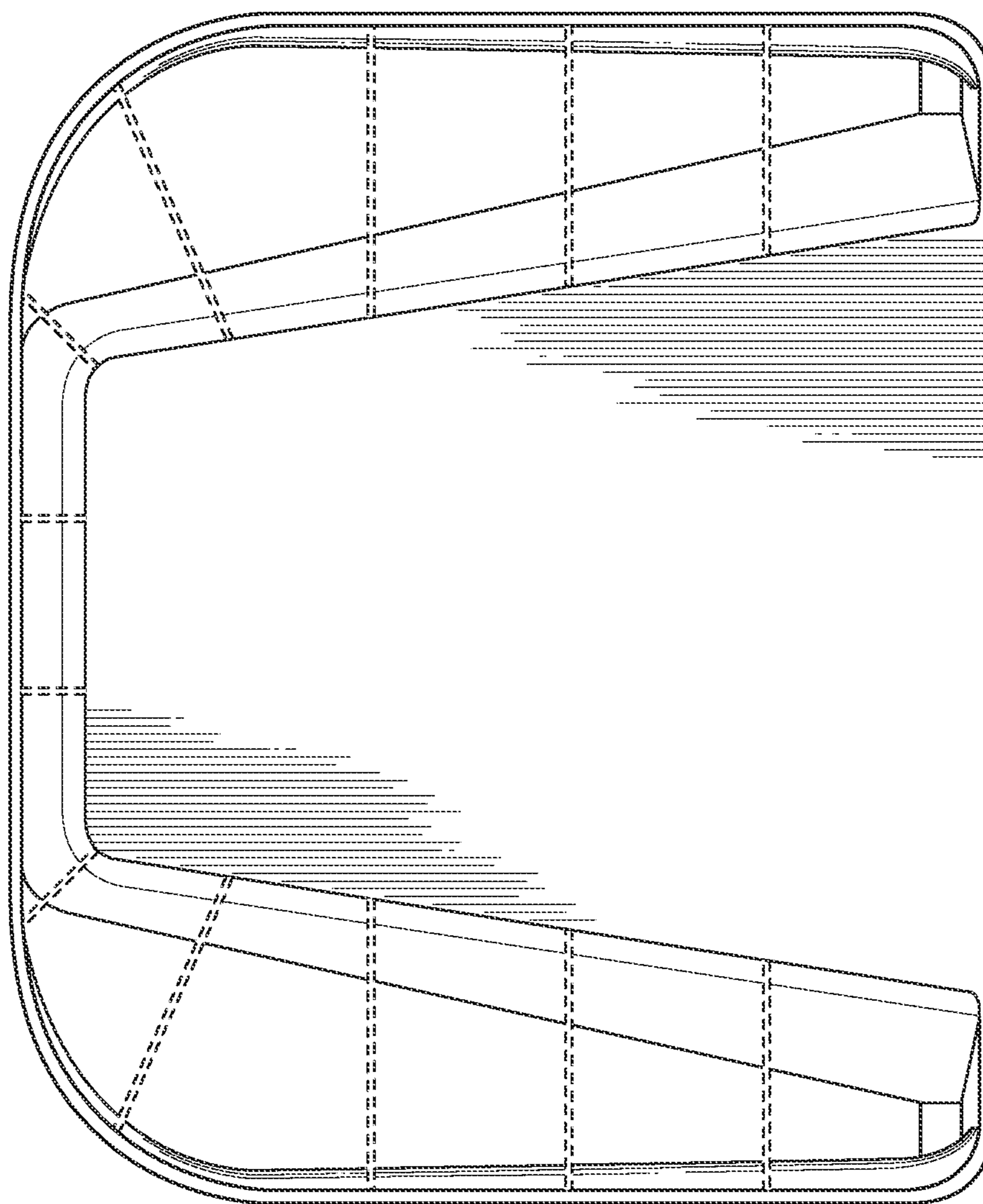

Fig. 4

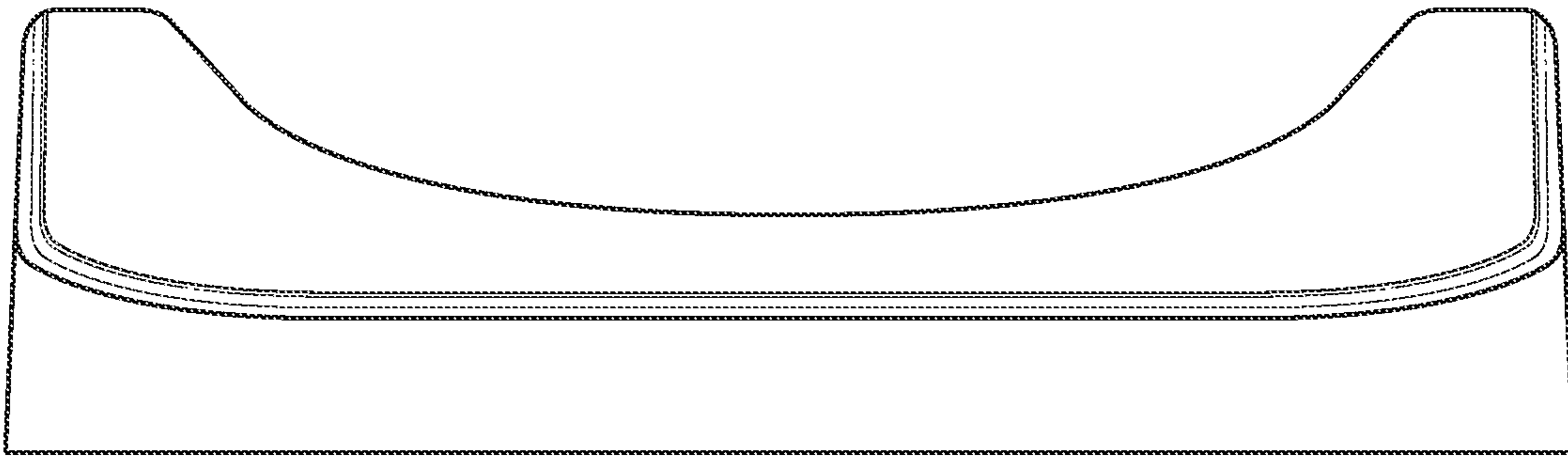

Fig. 5

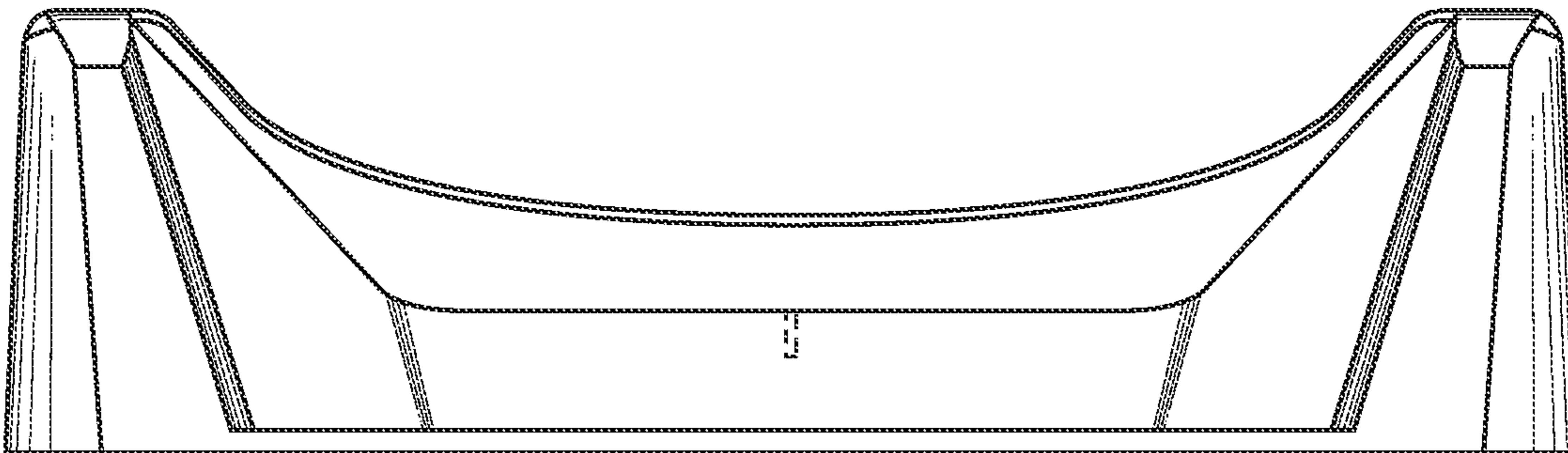

Fig. 6

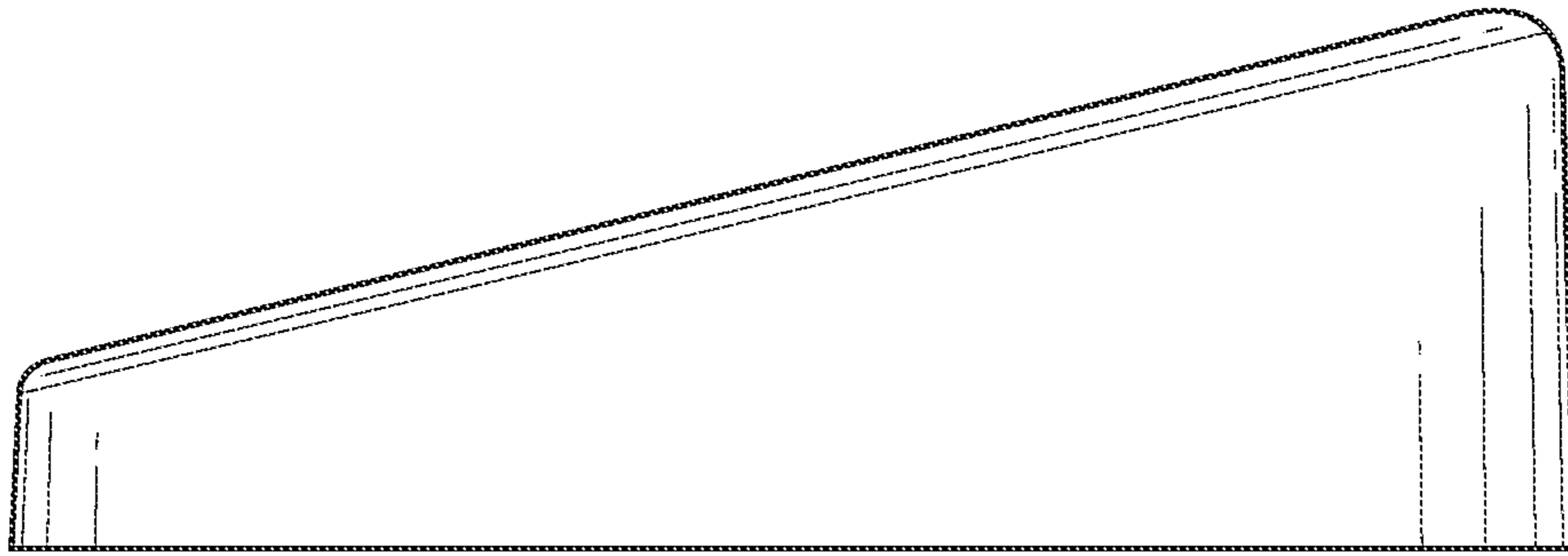

Fig. 7

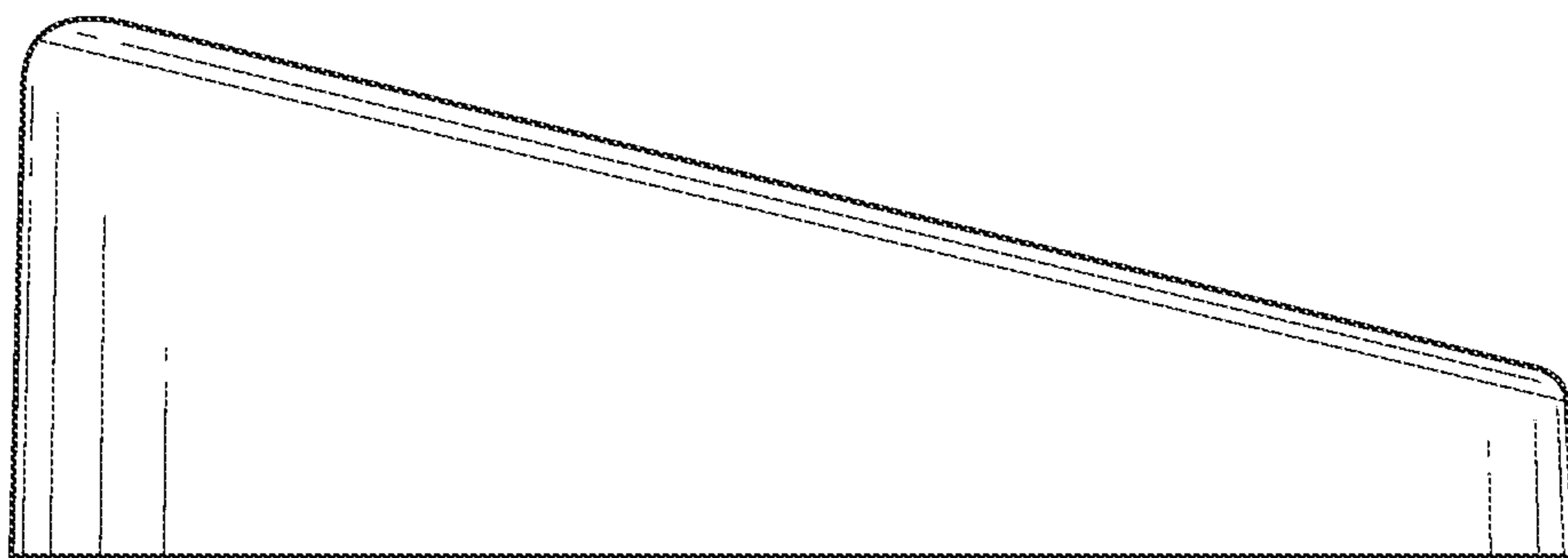

Fig. 8