



US00D943594S

(12) **United States Design Patent**  
**Chen et al.**

(10) **Patent No.:** **US D943,594 S**  
(45) **Date of Patent:** **\*\* Feb. 15, 2022**

- (54) **NOTEBOOK COMPUTER STAND**
- (71) Applicant: **Acer Incorporated**, New Taipei (TW)
- (72) Inventors: **Wei-Chang Chen**, New Taipei (TW);  
**Jung-Wei Tsao**, New Taipei (TW)
- (73) Assignee: **Acer Incorporated**, New Taipei (TW)
- (\*\*) Term: **15 Years**
- (21) Appl. No.: **29/751,443**
- (22) Filed: **Sep. 21, 2020**

D697,069 S *	1/2014	Tak .....	D14/447
D711,888 S *	8/2014	Huebner .....	D14/447
D733,155 S *	6/2015	van Hooft .....	D14/447
D804,490 S *	12/2017	Wei .....	D14/447
D864,974 S *	10/2019	Groiss .....	D14/447
D886,828 S *	6/2020	Huebner .....	D14/447
D887,418 S *	6/2020	Valentine .....	D14/447
D900,117 S *	10/2020	Soto .....	D14/447

\* cited by examiner

*Primary Examiner* — Angela J Lee  
(74) *Attorney, Agent, or Firm* — JCIPRNET

(30) **Foreign Application Priority Data**

- Jun. 12, 2020 (TW) ..... 109303147
- (51) **LOC (13) Cl.** ..... **08-07**
- (52) **U.S. Cl.**  
USPC ..... **D14/447**
- (58) **Field of Classification Search**  
USPC ..... D14/447, 432, 434, 439, 440, 451, 452,  
D14/457, 239, 253; D8/363, 373, 380;  
D6/406.3, 406.4, 406.5, 406.6; D12/415;  
D13/108  
CPC ..... A47B 21/04; A47B 2097/006; A47B  
2097/005; A47B 2023/049; A45C  
2011/002; A45C 2011/003; F16M  
2200/00; F16M 13/00  
See application file for complete search history.

(56) **References Cited**

**U.S. PATENT DOCUMENTS**

D413,872 S *	9/1999	Jessen .....	D14/447
D626,964 S *	11/2010	Richardson .....	D14/447
D667,011 S *	9/2012	Wu .....	D14/447
D684,963 S *	6/2013	Goodrich .....	D14/253
D689,870 S *	9/2013	Fong .....	D14/447

(57) **CLAIM**

The ornamental design for a notebook computer stand, as shown and described.

**DESCRIPTION**

FIG. 1 is a perspective view of a notebook computer stand showing our new design;  
 FIG. 2 is a front view thereof;  
 FIG. 3 is a rear view thereof;  
 FIG. 4 is a left side view thereof;  
 FIG. 5 is a right side view thereof;  
 FIG. 6 is a top view thereof;  
 FIG. 7 is a bottom view thereof;  
 FIG. 8 is a perspective view thereof, shown with environment;  
 FIG. 9 is a perspective view thereof, shown in a first alternate position;  
 FIG. 10 is a perspective view thereof, shown in a second alternate position with environment; and,  
 FIG. 11 is a perspective view thereof, shown in a third alternate position with environment.  
 The dashed broken lines in FIG. 8, FIG. 10 and FIG. 11 are for the purpose of depicting environment and form no part of the claimed design.

**1 Claim, 9 Drawing Sheets**

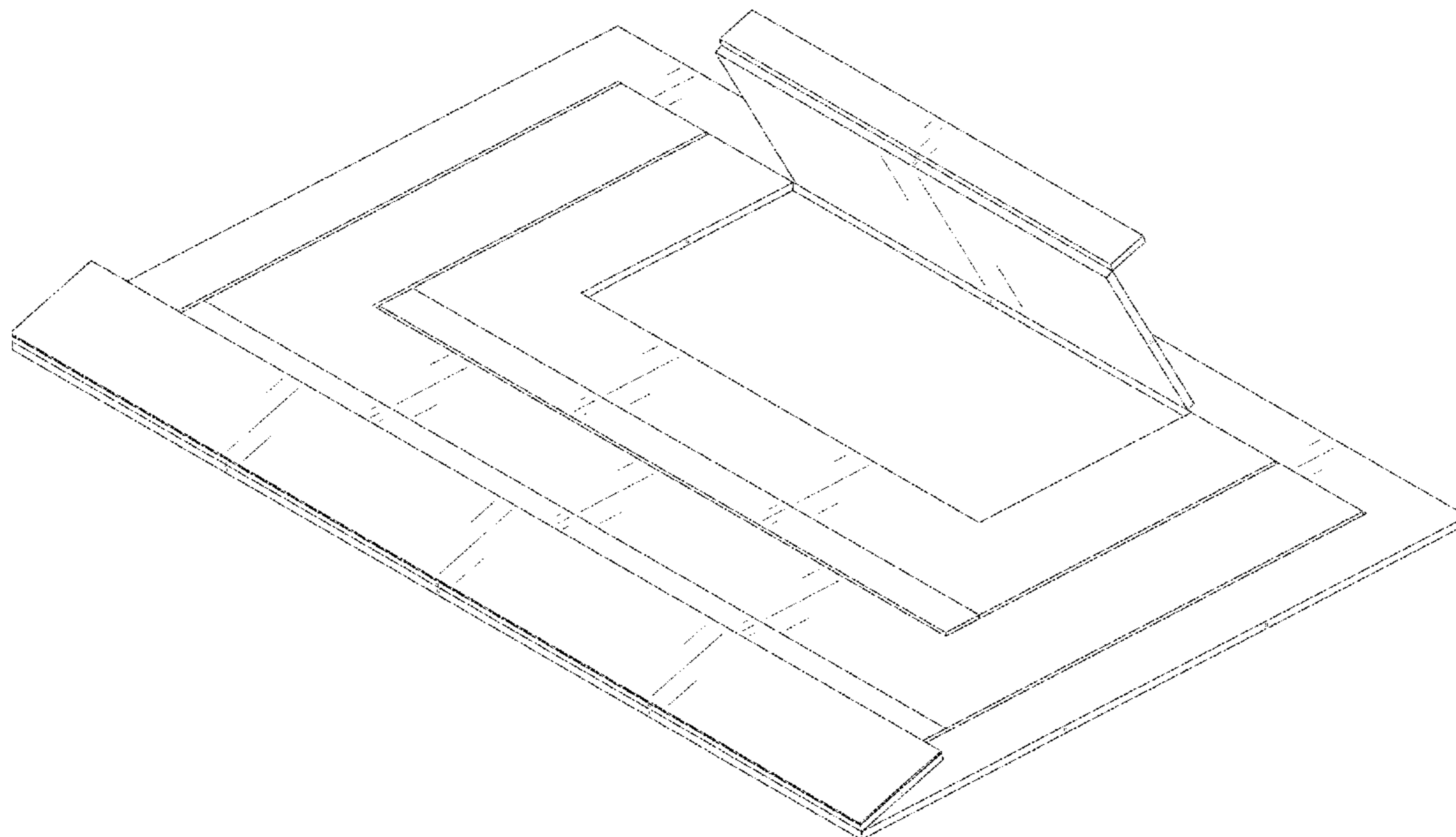

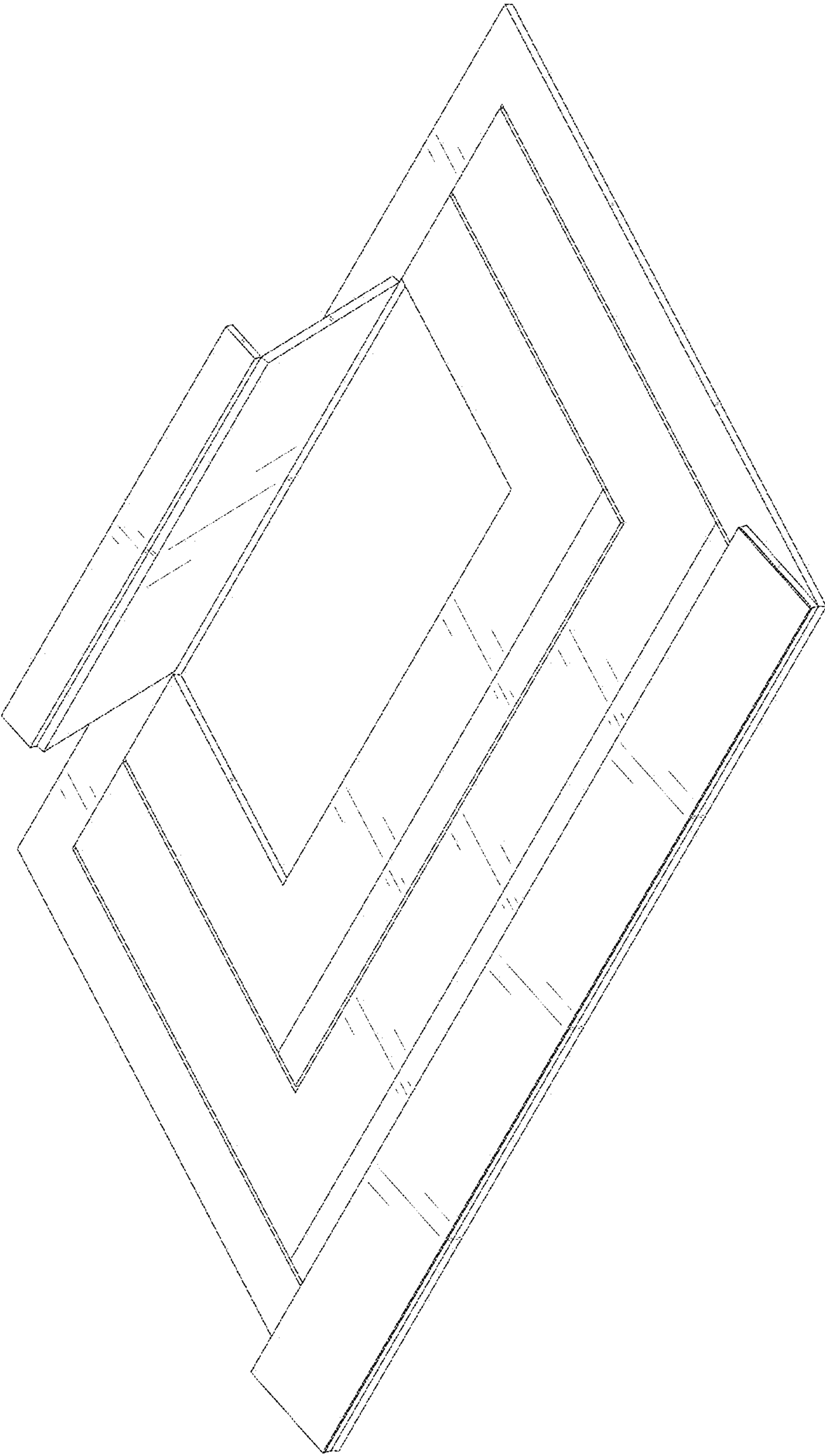

FIG. 1

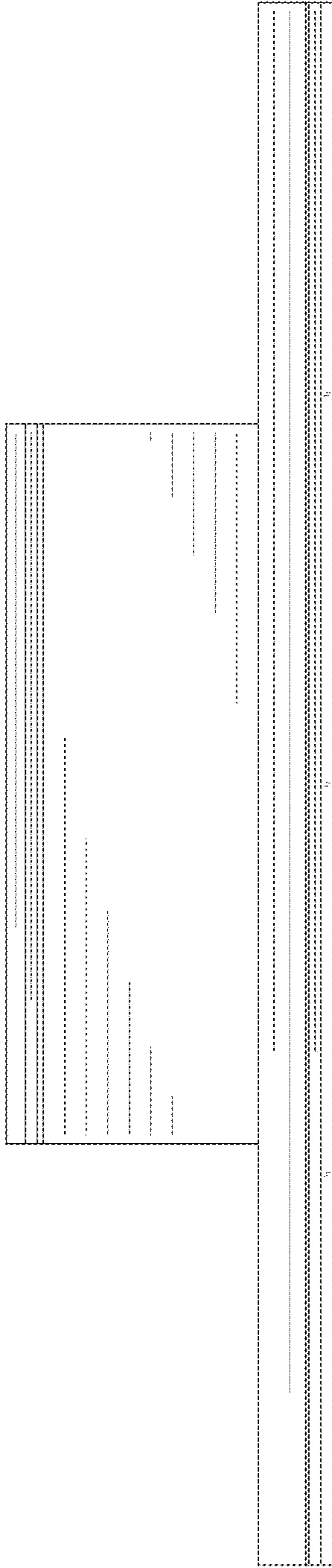

FIG. 2

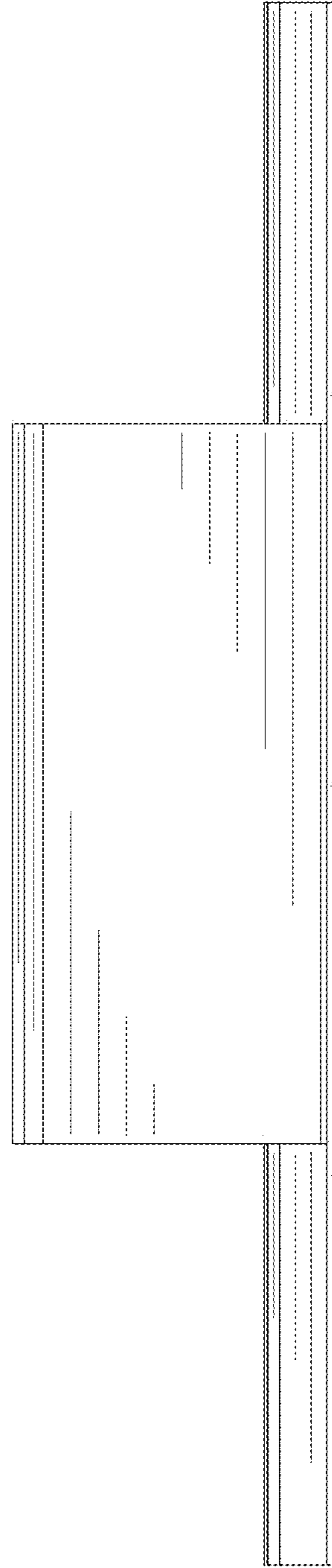

FIG. 3

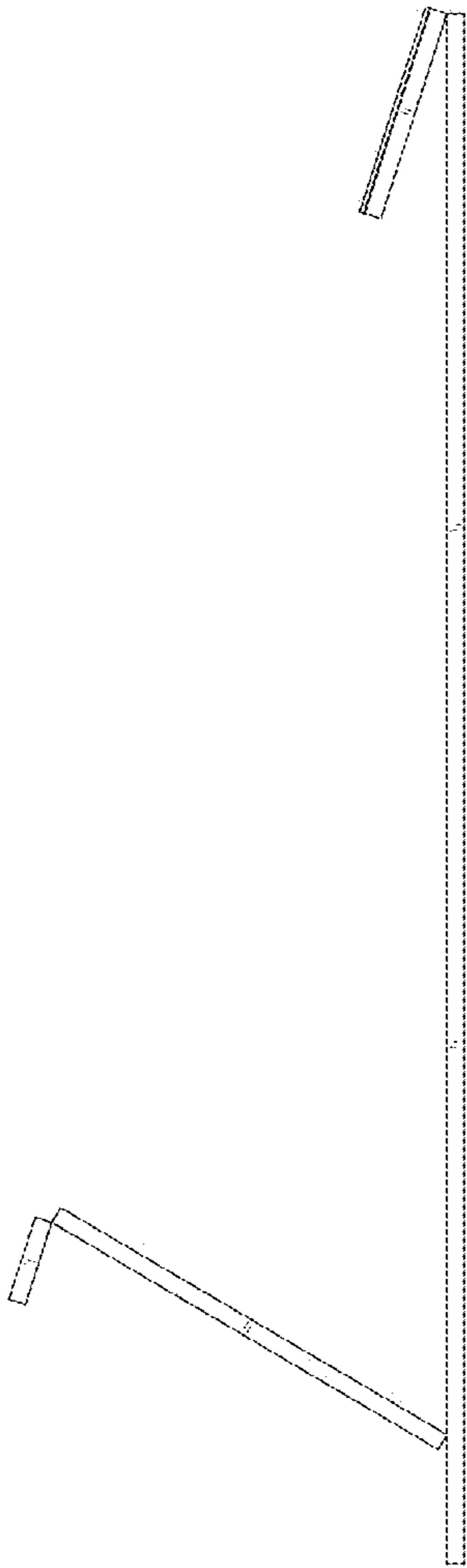

FIG. 4

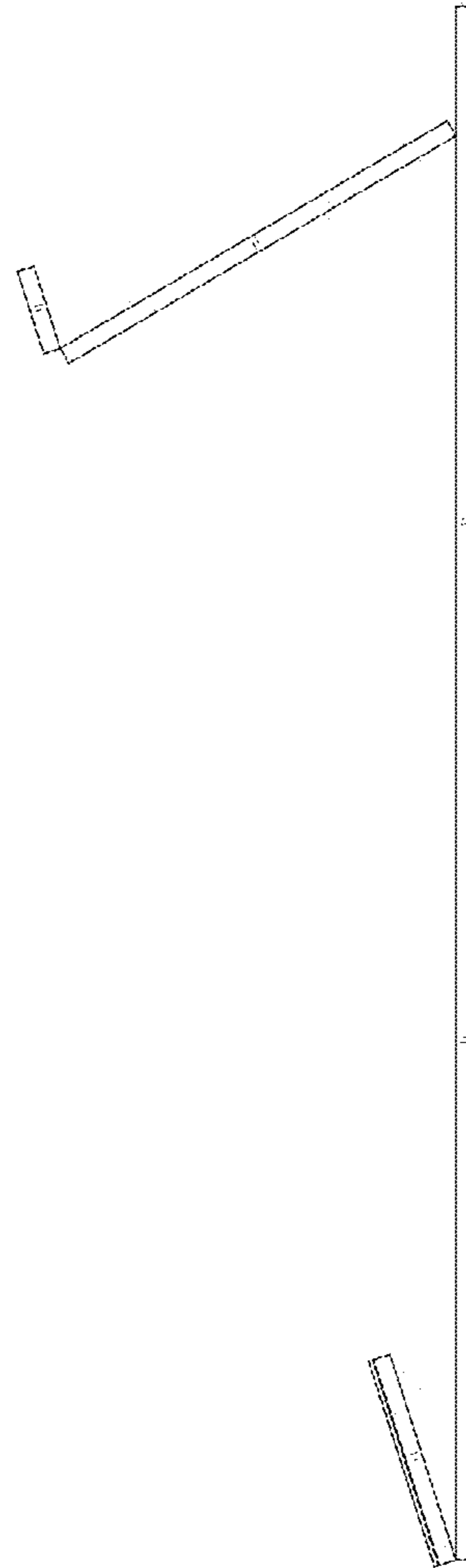

FIG. 5

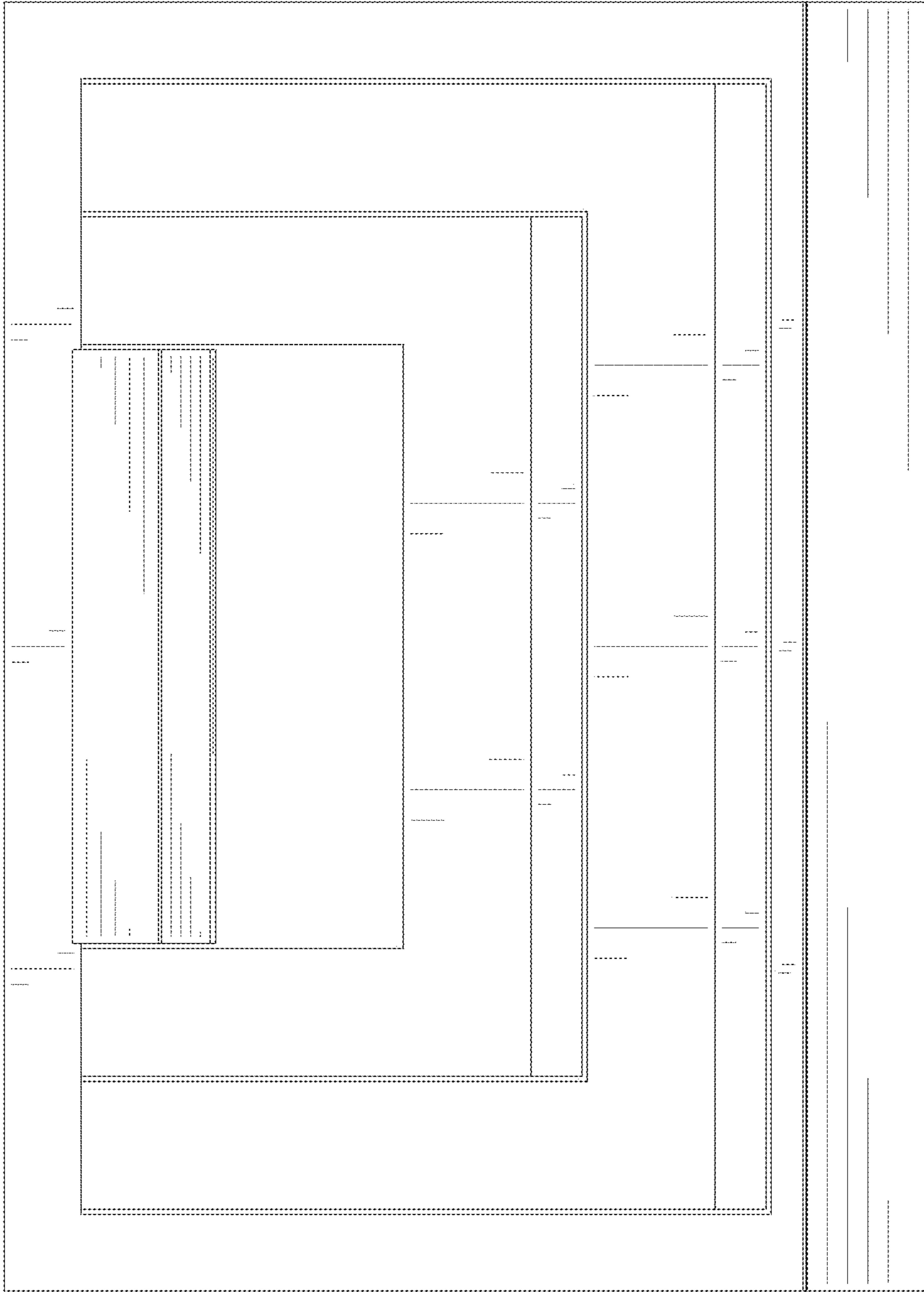

FIG. 6

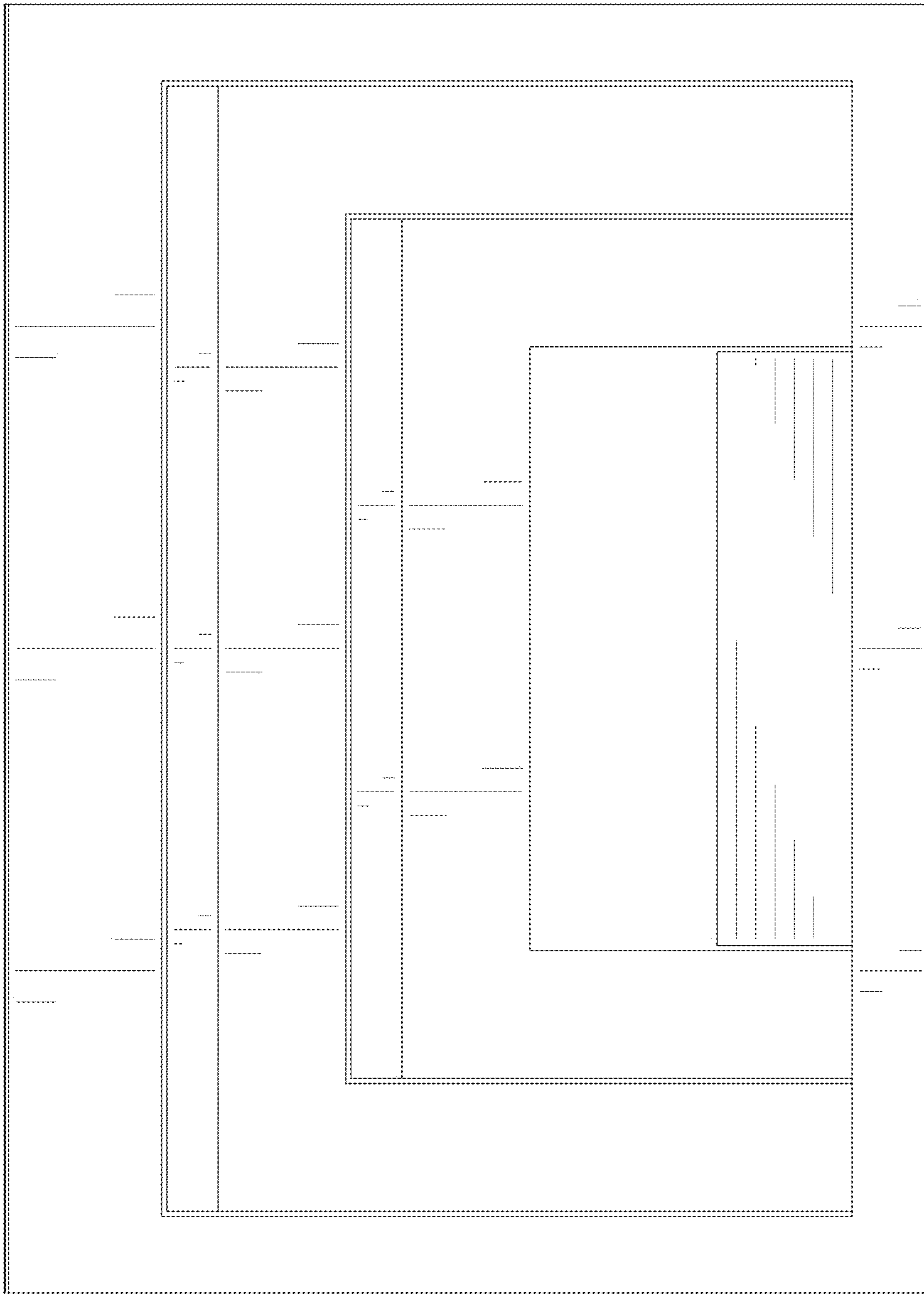

FIG. 7

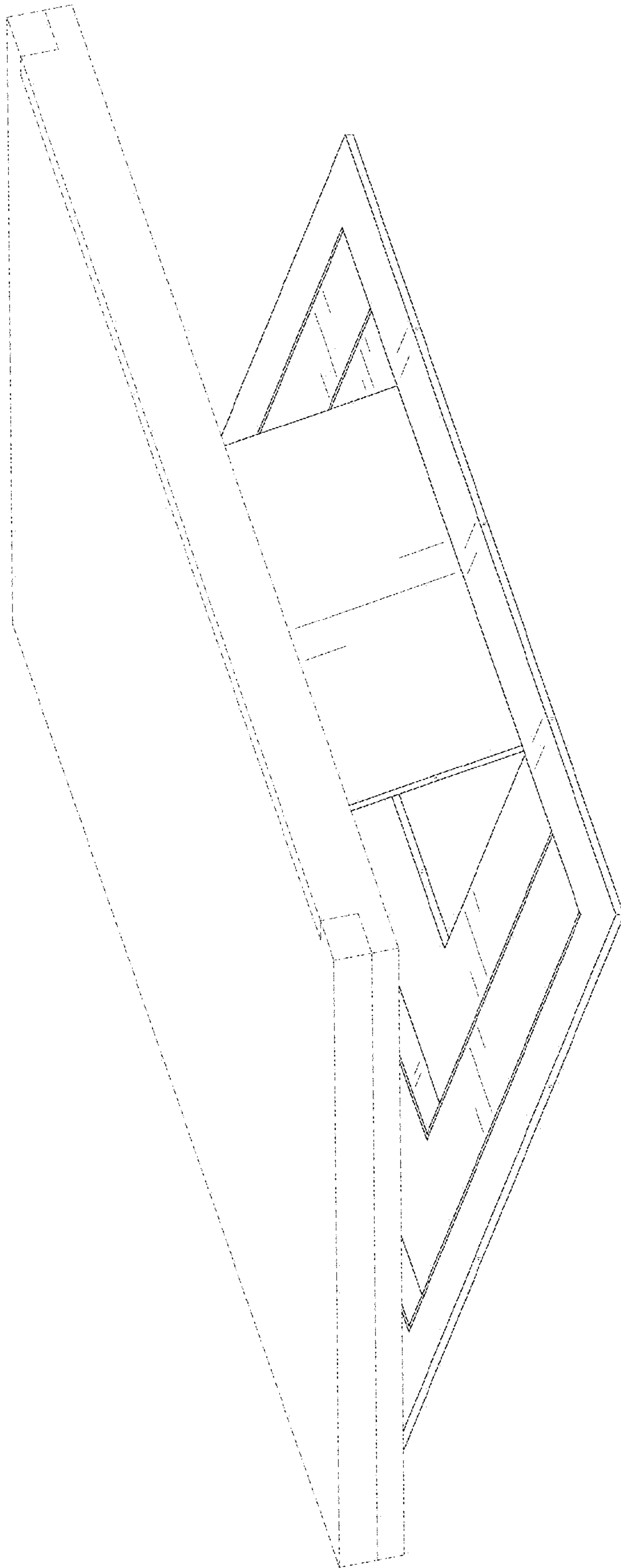

FIG. 8

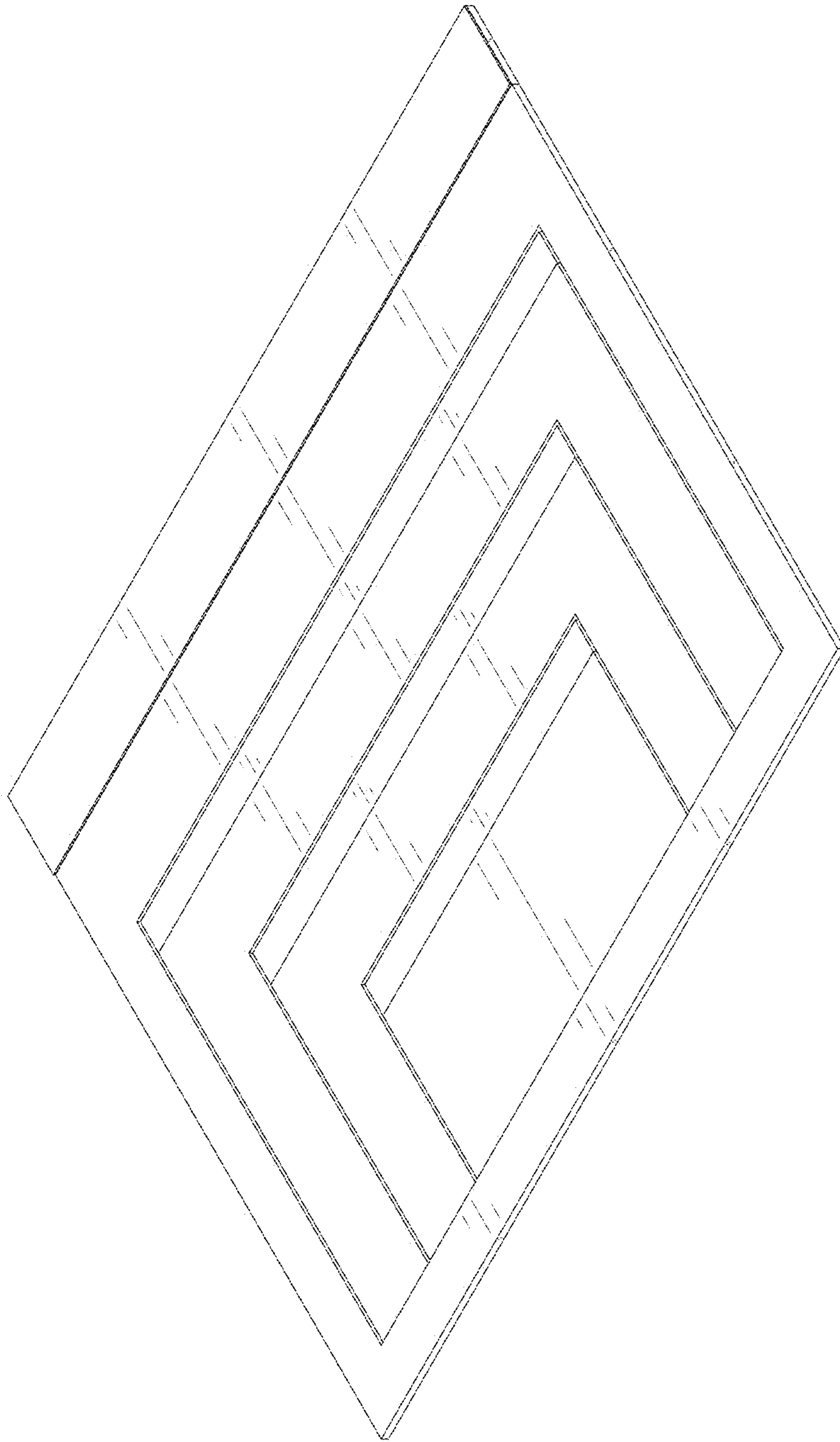

FIG. 9



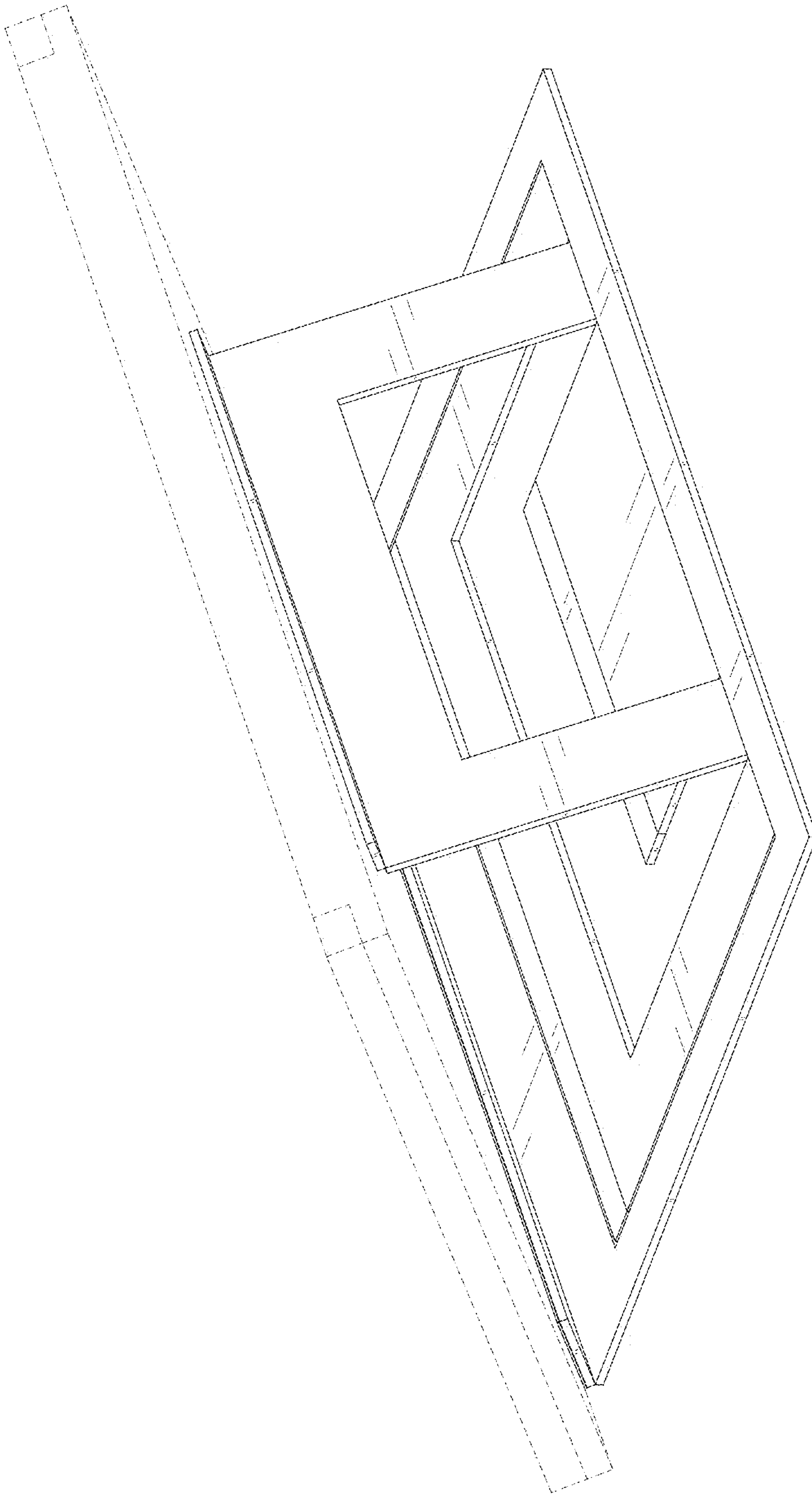

FIG. 10

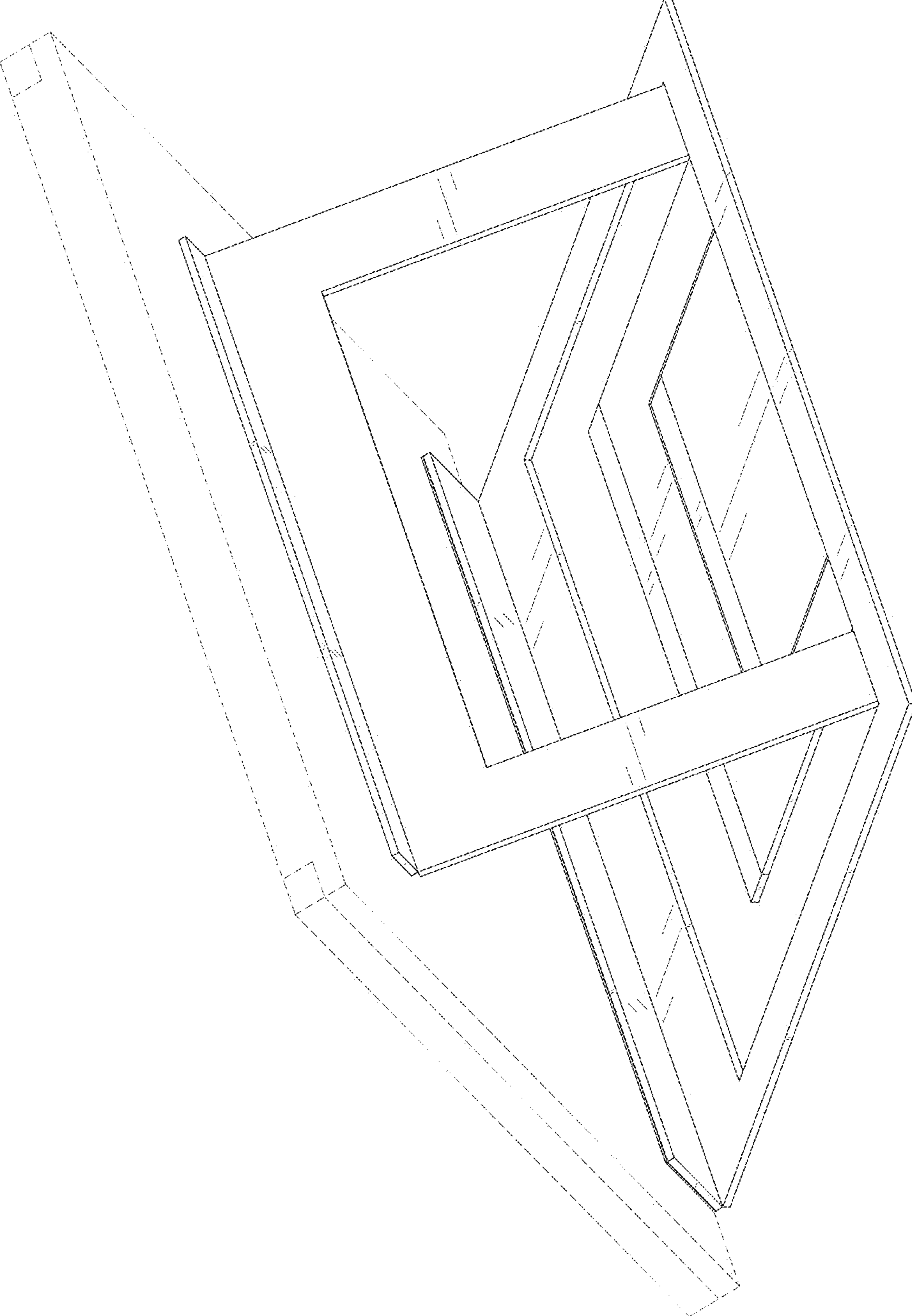

FIG. 11