



US00D943589S

(12) **United States Design Patent** (10) **Patent No.:** **US D943,589 S**
He (45) **Date of Patent:** **** Feb. 15, 2022**

(54) **IPAD LEATHER CASE**
(71) Applicant: **Jumei He**, Da County (CN)
(72) Inventor: **Jumei He**, Da County (CN)
(**) Term: **15 Years**
(21) Appl. No.: **29/738,956**
(22) Filed: **Jun. 22, 2020**
(51) **LOC (13) Cl.** **14-02**
(52) **U.S. Cl.**
USPC **D14/440**
(58) **Field of Classification Search**
USPC D14/440, 447, 250; 206/45.23, 320,
206/45.2; 361/679.55; 294/25; 224/218
CPC G06F 1/1628; G06F 1/1626; H04B 1/3888
See application file for complete search history.

(56) **References Cited**

U.S. PATENT DOCUMENTS

1,613,536	A *	1/1927	Rose	132/315
4,259,568	A *	3/1981	Dynesen	235/1 D
6,772,879	B1 *	8/2004	Domotor	206/45.23
7,281,698	B2 *	10/2007	Patterson, Jr.	248/458
7,414,833	B2 *	8/2008	Kittayapong	361/679.27
7,735,644	B2 *	6/2010	Sirichai et al.	206/320
D658,187	S *	4/2012	Diebel	D14/440
D658,188	S *	4/2012	Diebel	D14/440
D663,304	S *	7/2012	Akana	D14/440
8,230,992	B2 *	7/2012	Law et al.	206/320
8,245,843	B1 *	8/2012	Wu	206/320
8,312,991	B2 *	11/2012	Diebel et al.	206/45.24
D671,948	S *	12/2012	Akana et al.	D14/440
D672,353	S *	12/2012	Liu	D14/440
D672,781	S *	12/2012	Lu	D14/440
D675,625	S *	2/2013	Hasbrook et al.	D14/440
D678,260	S *	3/2013	Bau	D14/250
D679,279	S *	4/2013	Yang et al.	D14/440
D679,715	S *	4/2013	Akana et al.	D14/440
8,424,830	B2 *	4/2013	Yang et al.	248/459

D681,641	S *	5/2013	Van Den Nieuwenhuizen et al.	D14/440
D682,836	S *	5/2013	Akana et al.	D14/440
D682,838	S *	5/2013	Akana et al.	D14/440
D683,141	S *	5/2013	Symons	D6/310
D687,438	S *	8/2013	Lu	D14/440
D690,305	S *	9/2013	Wen	D14/440
D690,702	S *	10/2013	Chung	D14/440
D691,142	S *	10/2013	Diebel	D14/440
D692,434	S *	10/2013	Kim	D14/440
D693,823	S *	11/2013	Chen	D14/440
D695,296	S *	12/2013	Hsu	D14/440
D696,253	S *	12/2013	Akana et al.	D14/345
D696,256	S *	12/2013	Piedra	D14/440
D696,669	S *	12/2013	Akana et al.	D14/440
8,640,864	B2 *	2/2014	Chen et al.	206/45.2
8,657,112	B2 *	2/2014	Igarashi	206/320

(Continued)

Primary Examiner — Cynthia R Underwood
(74) *Attorney, Agent, or Firm* — Rumit Ranjit Kanakia

(57) **CLAIM**

I claim the ornamental design for an ipad leather case, as shown and described.

DESCRIPTION

FIG. 1 is a Perspective view of an ipad leather case showing my new design;
FIG. 2 is a Front view thereof;
FIG. 3 is a Back side view thereof;
FIG. 4 is a Right-side view thereof;
FIG. 5 is a Left-side view thereof;
FIG. 6 is a Top view thereof;
FIG. 7 is a Bottom thereof; and,
FIG. 8 is other perspective view of an ipad leather case showing my new design in open position.
The short dash-short dash broken lines depict portions of the invention that form no part of the claim. The long dash-long dash broken lines depict stitching and are part of the claimed design.

1 Claim, 6 Drawing Sheets

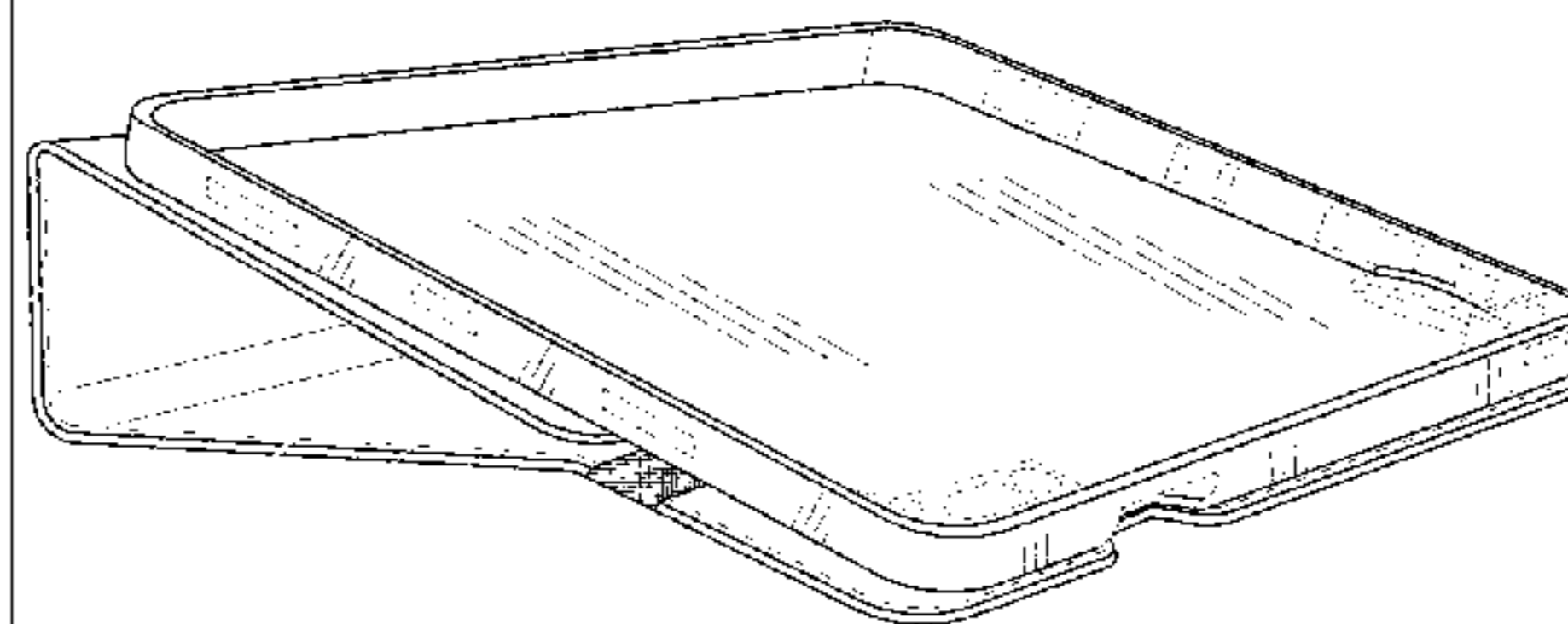
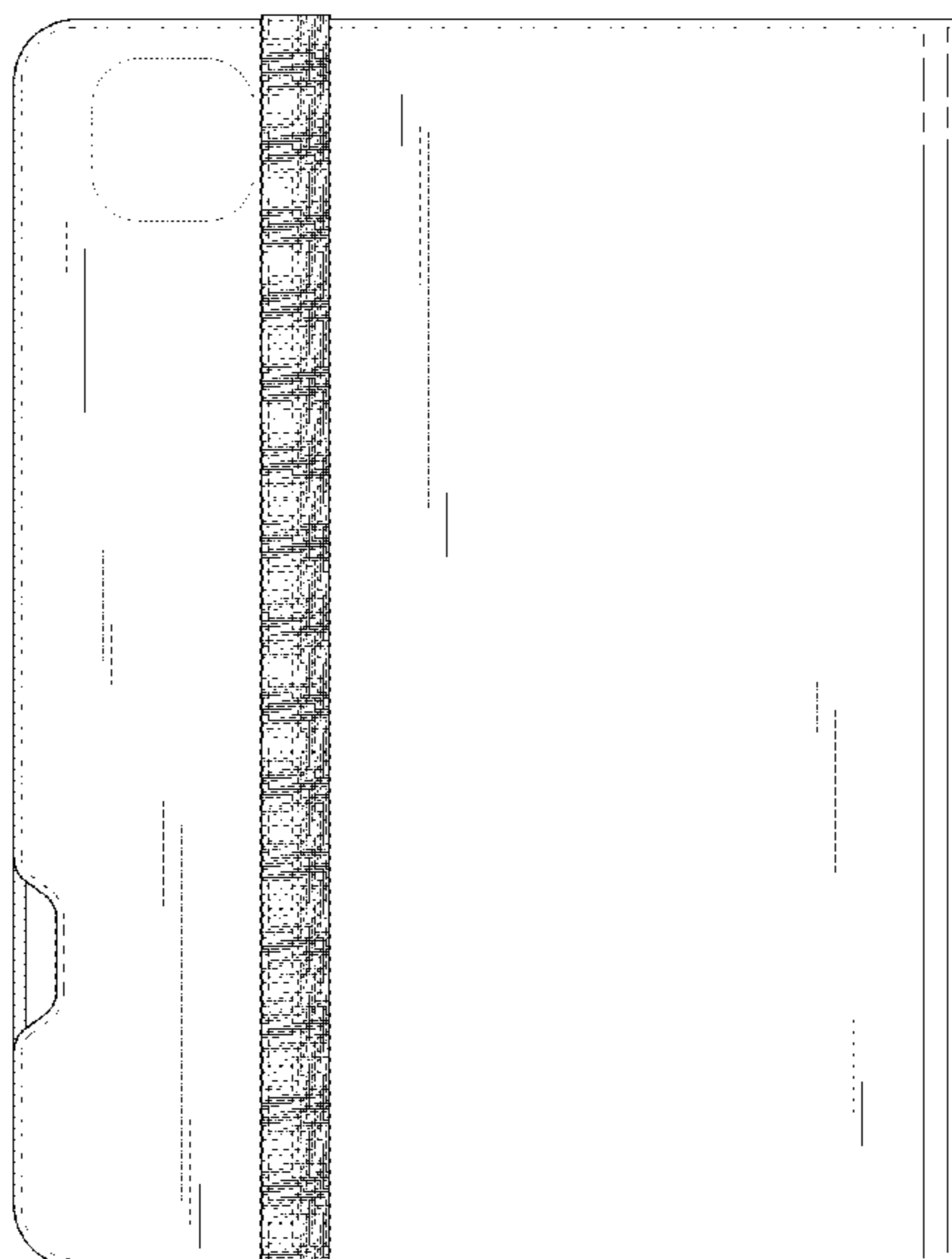

(56)

References Cited

U.S. PATENT DOCUMENTS

D701,205 S * 3/2014 Akana et al. D14/345
 D702,673 S * 4/2014 Murchison et al. D14/250
 D704,689 S * 5/2014 Chang D14/250
 D704,693 S * 5/2014 Kim D14/250
 D706,270 S * 6/2014 Akana et al. D14/440
 D706,783 S * 6/2014 Almodova D14/440
 D707,229 S * 6/2014 Almodova D14/440
 8,757,375 B2 * 6/2014 Huang 206/320
 D708,838 S * 7/2014 Lee D3/201
 8,763,795 B1 * 7/2014 Oten et al. 206/45.23
 8,766,921 B2 * 7/2014 Ballagas et al. 345/168
 8,773,353 B2 * 7/2014 Wei 345/156
 8,783,458 B2 * 7/2014 Gallagher et al. 206/320
 D710,859 S * 8/2014 Mecchella D14/440
 8,797,132 B2 * 8/2014 Childs et al. 335/219
 D713,847 S * 9/2014 Su D14/440
 D713,848 S * 9/2014 Akana et al. D14/440
 D864,972 S * 10/2019 Chen D14/440
 D868,071 S * 11/2019 Liu D14/440
 D871,415 S * 12/2019 Lin D14/440
 D874,466 S * 2/2020 Lei D14/440
 D875,735 S * 2/2020 Buechin G06F 1/16
 D14/440
 D883,986 S * 5/2020 Akana D14/440
 D885,402 S * 5/2020 Lei D14/440
 D887,415 S * 6/2020 Claudepierre D14/440
 D888,718 S * 6/2020 Xu D14/440
 D889,474 S * 7/2020 Akana D14/440
 D890,183 S * 7/2020 Zhao D14/440
 D892,126 S * 8/2020 Kim D14/440
 D896,233 S * 9/2020 Chen D14/440
 D898,746 S * 10/2020 Buechin A45C 11/00
 D14/440

D904,413 S * 12/2020 Feng D14/440
 D907,044 S * 1/2021 Cheng D14/440
 D907,046 S * 1/2021 Kao D14/440
 D907,047 S * 1/2021 Kao D14/440
 D909,391 S * 2/2021 Cheng D14/440
 D910,026 S * 2/2021 Li D14/440
 D910,642 S * 2/2021 Li D14/440
 D910,643 S * 2/2021 Li D14/440
 D912,059 S * 3/2021 Zhao D14/440
 D912,060 S * 3/2021 Zhu D14/440
 D912,063 S * 3/2021 Yan D14/440
 D913,293 S * 3/2021 Feng D14/440
 D920,335 S * 5/2021 Akana et al. D14/440
 D921,637 S * 6/2021 Cheng D14/440
 D922,390 S * 6/2021 Cheng D14/440
 D922,391 S * 6/2021 Cheng D14/440
 D923,011 S * 6/2021 Cheng D14/440
 D924,244 S * 7/2021 Akana et al. D14/440
 D924,880 S * 7/2021 Akana et al. D14/440
 D928,788 S * 8/2021 Kang et al. D14/440
 2003/0034263 A1 * 2/2003 D'Hoste 206/320
 2008/0302687 A1 * 12/2008 Sirichai et al. 206/320
 2009/0159763 A1 * 6/2009 Kim 248/174
 2011/0266194 A1 * 11/2011 Bau 206/736
 2011/0290687 A1 * 12/2011 Han 206/320
 2012/0211377 A1 * 8/2012 Sajid 206/216
 2012/0211613 A1 * 8/2012 Yang et al. 248/174
 2012/0305413 A1 * 12/2012 Chung 206/45.23
 2012/0308981 A1 * 12/2012 Libin et al. 434/362
 2013/0015088 A1 * 1/2013 Wu 206/320
 2013/0020216 A1 * 1/2013 Chiou 206/320
 2013/0140203 A1 * 6/2013 Chiang 206/320
 2013/0213838 A1 * 8/2013 Tsai et al. 206/320
 2013/0214661 A1 * 8/2013 McBroom 312/325
 2013/0241381 A1 * 9/2013 Hyneczek et al. 312/240
 2013/0264459 A1 * 10/2013 McCosh et al. 248/688

* cited by examiner

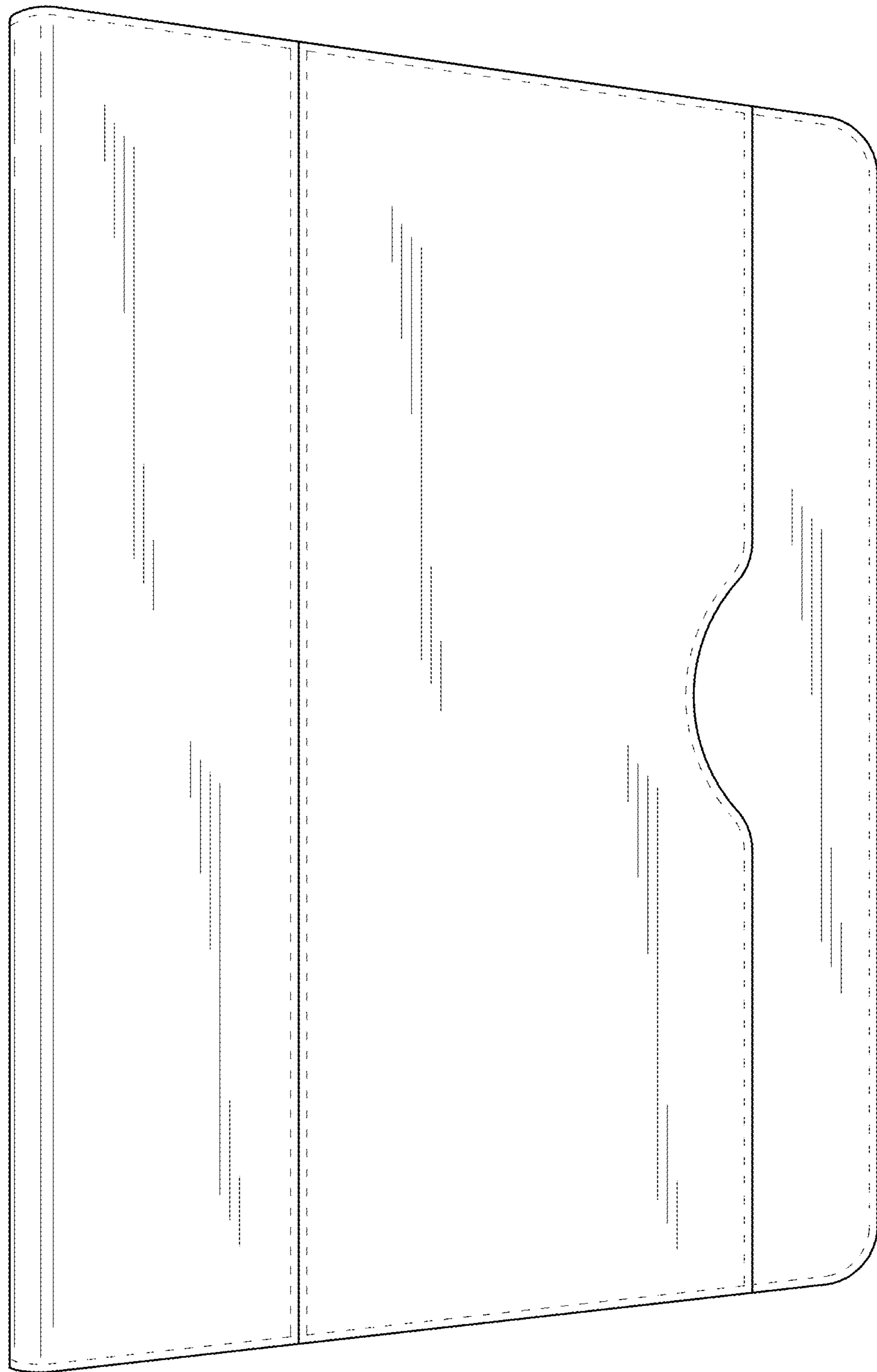

FIG. 1

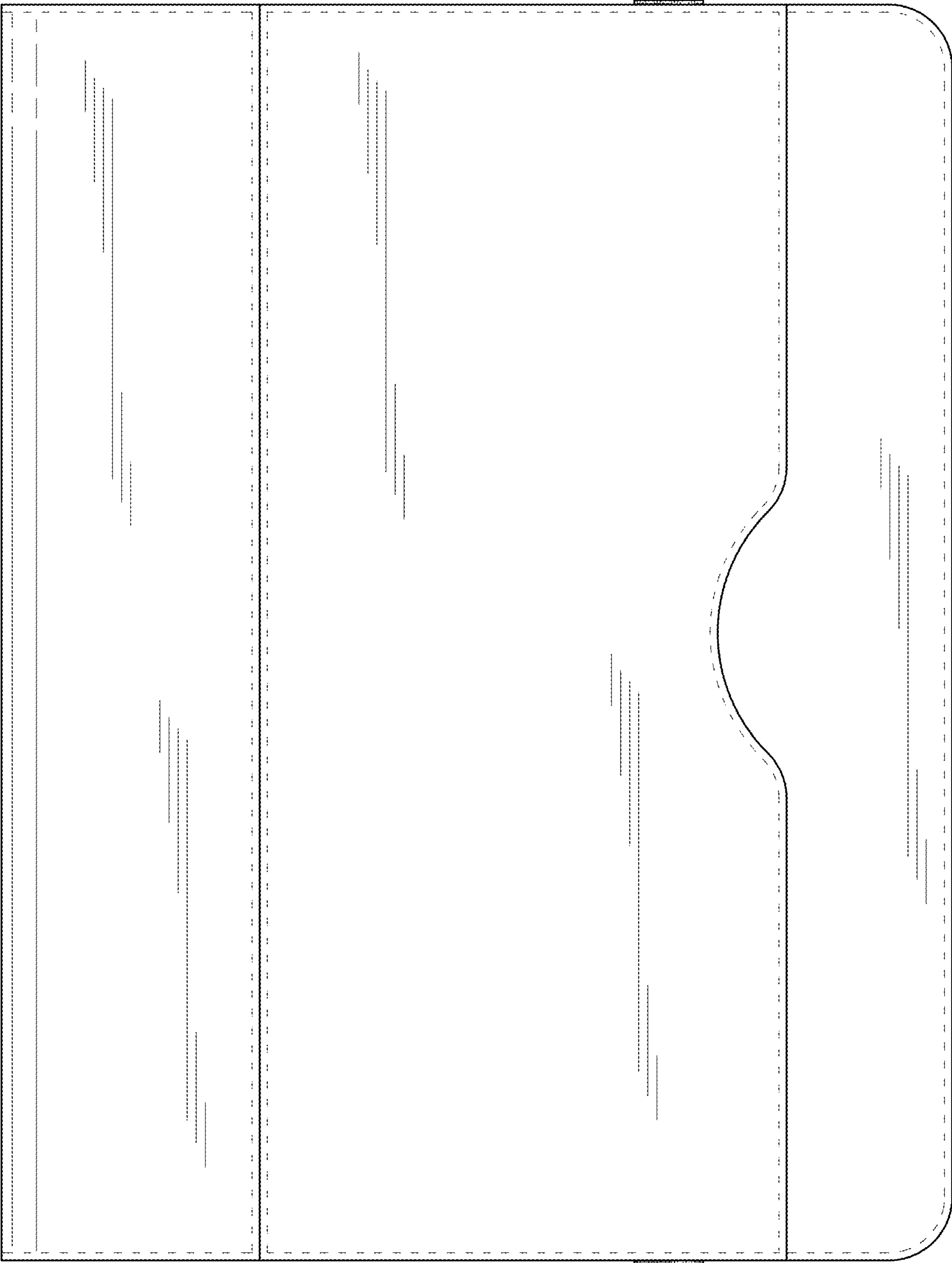

FIG. 2

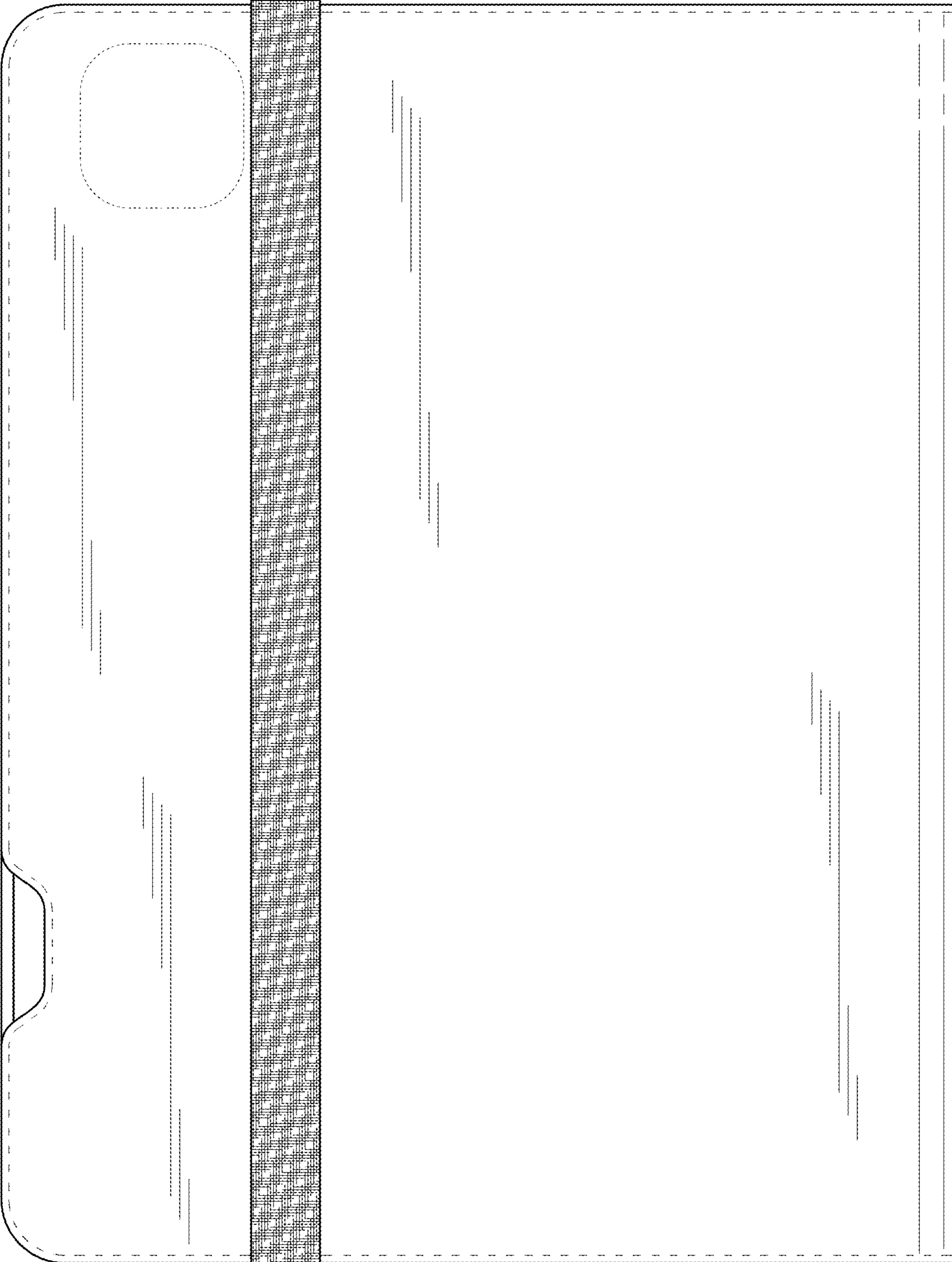

FIG. 3

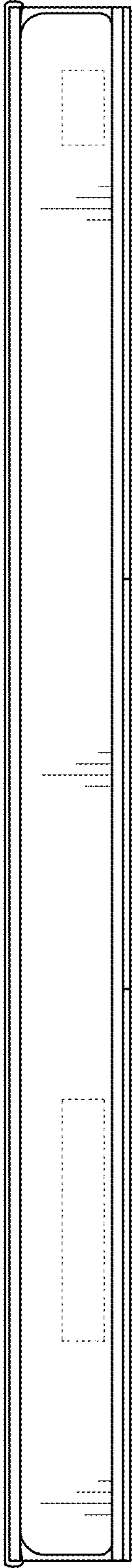

FIG. 4

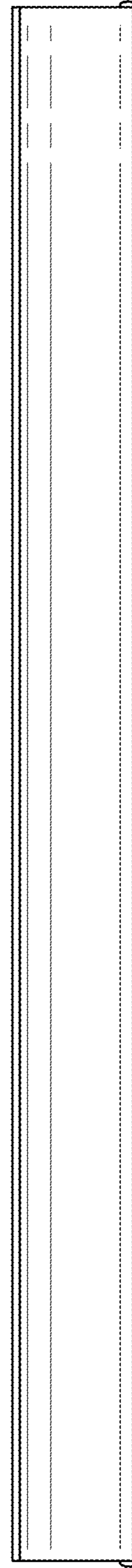

FIG. 5

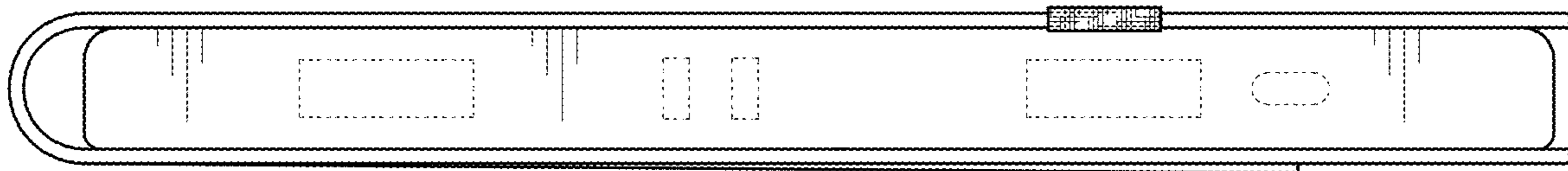

FIG. 6

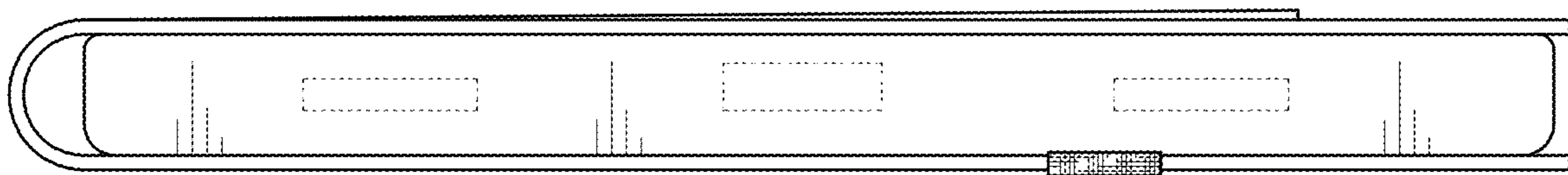

FIG. 7

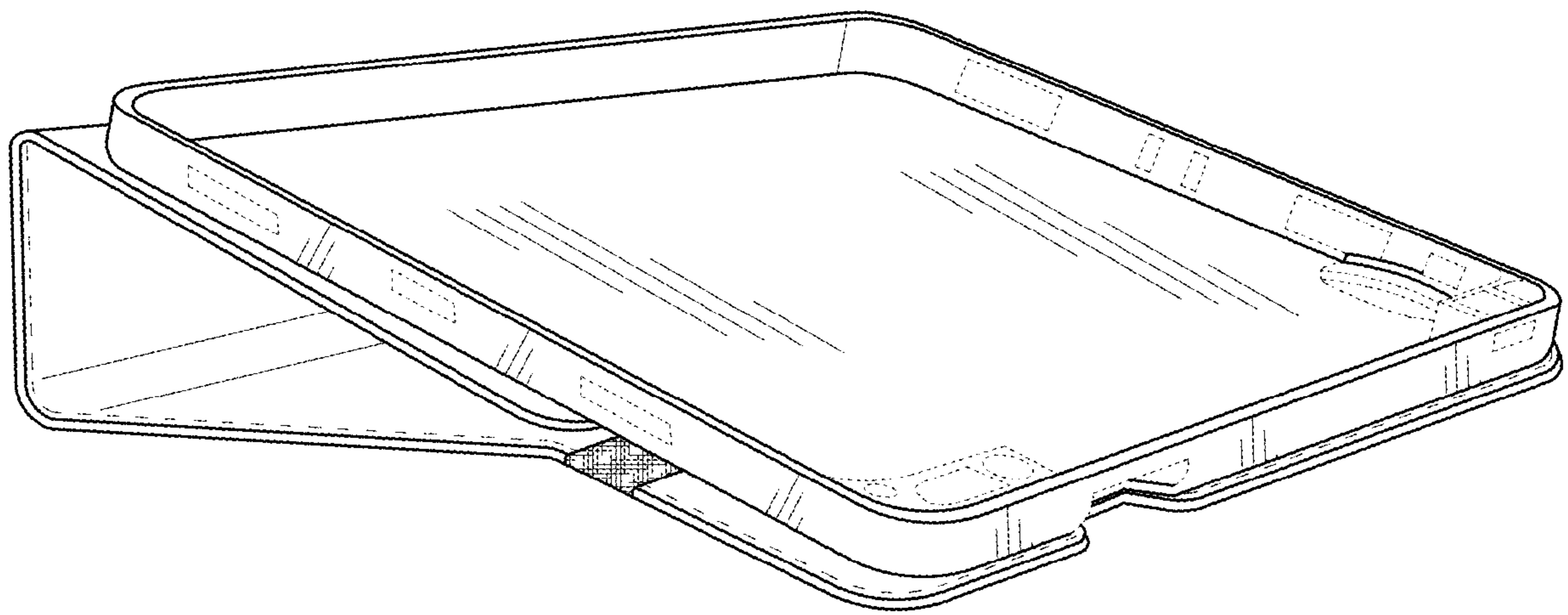

FIG. 8