



US00D943567S

(12) **United States Design Patent**
Mundt

(10) **Patent No.:** **US D943,567 S**

(45) **Date of Patent:** **** Feb. 15, 2022**

(54) **SOUND CUP**

(71) Applicant: **Philip Mundt**, Clinton Township, MI (US)

(72) Inventor: **Philip Mundt**, Clinton Township, MI (US)

(**) Term: **15 Years**

(21) Appl. No.: **29/699,043**

(22) Filed: **Jul. 23, 2019**

(51) **LOC (13) Cl.** **14-03**

(52) **U.S. Cl.**
USPC **D14/253**

(58) **Field of Classification Search**
USPC D14/251-253, 440, 447, 217, 238.1, D14/203.8, 209.1; D12/415; D3/218, D3/247, 249; D13/108; D6/310; D8/353; D16/237, 239; D26/51, 37, 38, D26/44
CPC H04M 1/04; H04M 1/21; H04M 1/0266; F16M 13/00; F16M 11/041; B60R 11/0241; B60R 11/0252; B60R 2011/0059; B60R 2011/0063; B60R 2011/0005; B60R 2011/0003; B60R 2011/0078; H02J 7/0027; H02J 2310/22; A45F 2200/0516; A45F 5/00; A45F 2200/0525; A45F 5/10; A45C 2011/002; G03B 17/561; G03B 27/582; A47B 97/04; G09F 1/00

See application file for complete search history.

(56) **References Cited**

U.S. PATENT DOCUMENTS

- 4,396,089 A * 8/1983 Scully G10K 11/16 181/242
- D451,504 S * 12/2001 Edwards D14/253
- D460,962 S * 7/2002 Peiker D14/253

- D478,073 S * 8/2003 Topinka D14/253
- D478,741 S * 8/2003 White D19/77
- D524,807 S * 7/2006 Topinka D14/253
- 7,099,466 B2 * 8/2006 Walsh B60R 11/0241 248/309.1
- D639,273 S * 6/2011 Chow D14/209.1
- D640,248 S * 6/2011 Baumann D14/253
- D645,047 S * 9/2011 Wike D14/447
- D677,650 S * 3/2013 Bosa D14/208
- D691,125 S * 10/2013 Cheon D14/253
- D711,364 S * 8/2014 Barker D14/252
- D714,282 S * 9/2014 Cheon D14/252
- D734,292 S * 7/2015 Barone D14/188
- D738,847 S * 9/2015 Park D14/188
- D740,249 S * 10/2015 Park D14/188
- D746,262 S * 12/2015 Barker D14/208
- D772,198 S * 11/2016 Hsiao D14/208
- D784,317 S * 4/2017 Mecchella D14/253
- D785,595 S * 5/2017 Morin D14/208
- D867,332 S * 11/2019 Xiao D14/209.1
- D920,322 S * 5/2021 Stefanelli D14/253
- D927,497 S * 8/2021 Date D14/447

* cited by examiner

Primary Examiner — Janice Hallmark

(57) **CLAIM**

The ornamental design for a sound cup, as shown and described.

DESCRIPTION

FIG. 1 is a front, three-quarters perspective view of a sound cup, showing my new design with the rear being a mirror image thereof;

FIG. 2 is a front plan view thereof;

FIG. 3 is a rear plan view thereof;

FIG. 4 is a sectional view thereof, taken along line 4-4 of FIG. 3;

FIG. 5 is a sectional view thereof, taken along line 5-5 of FIG. 2;

FIG. 6 is a bottom plan view thereof; and,

FIG. 7 is a top perspective view thereof.

1 Claim, 5 Drawing Sheets

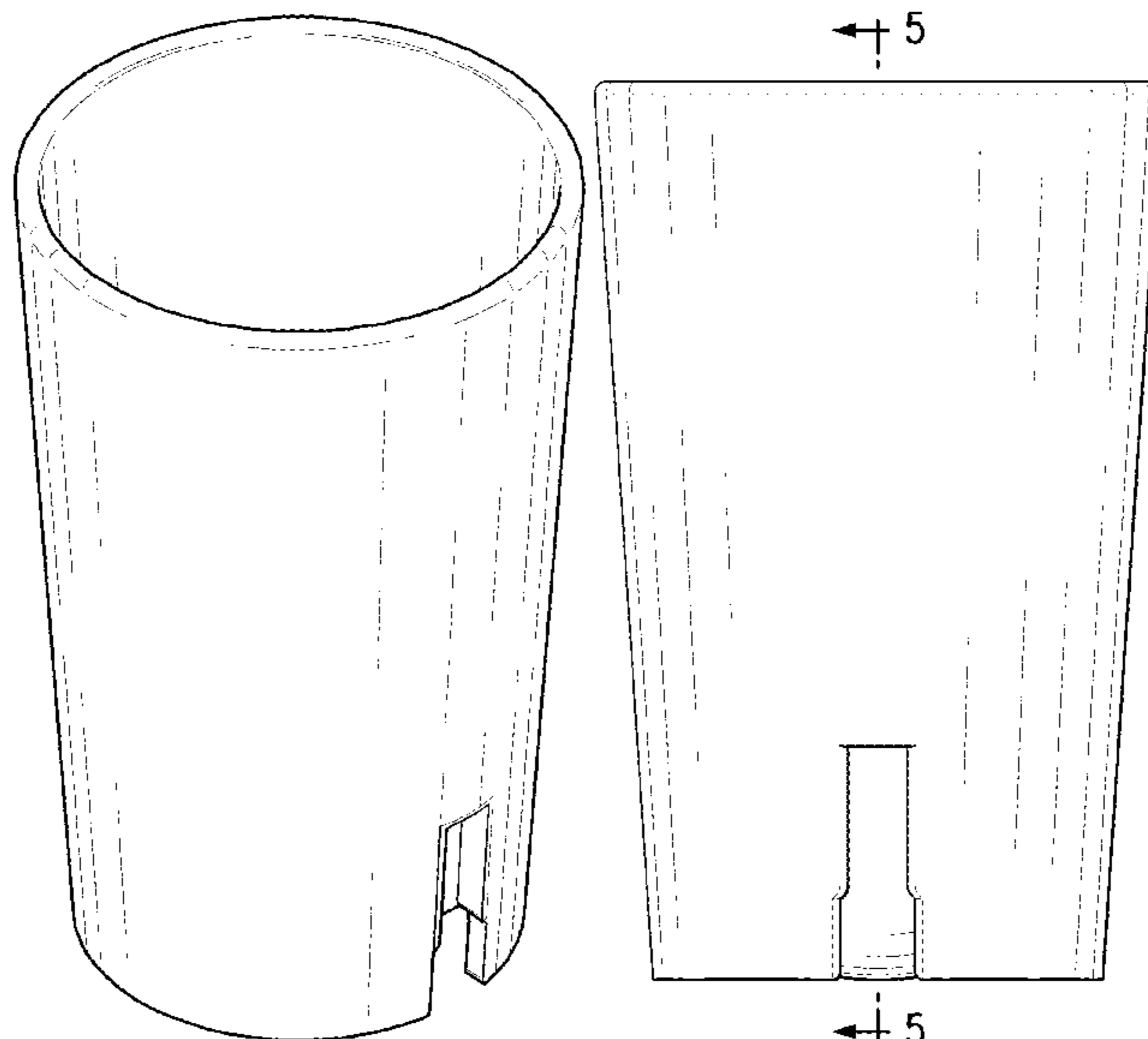

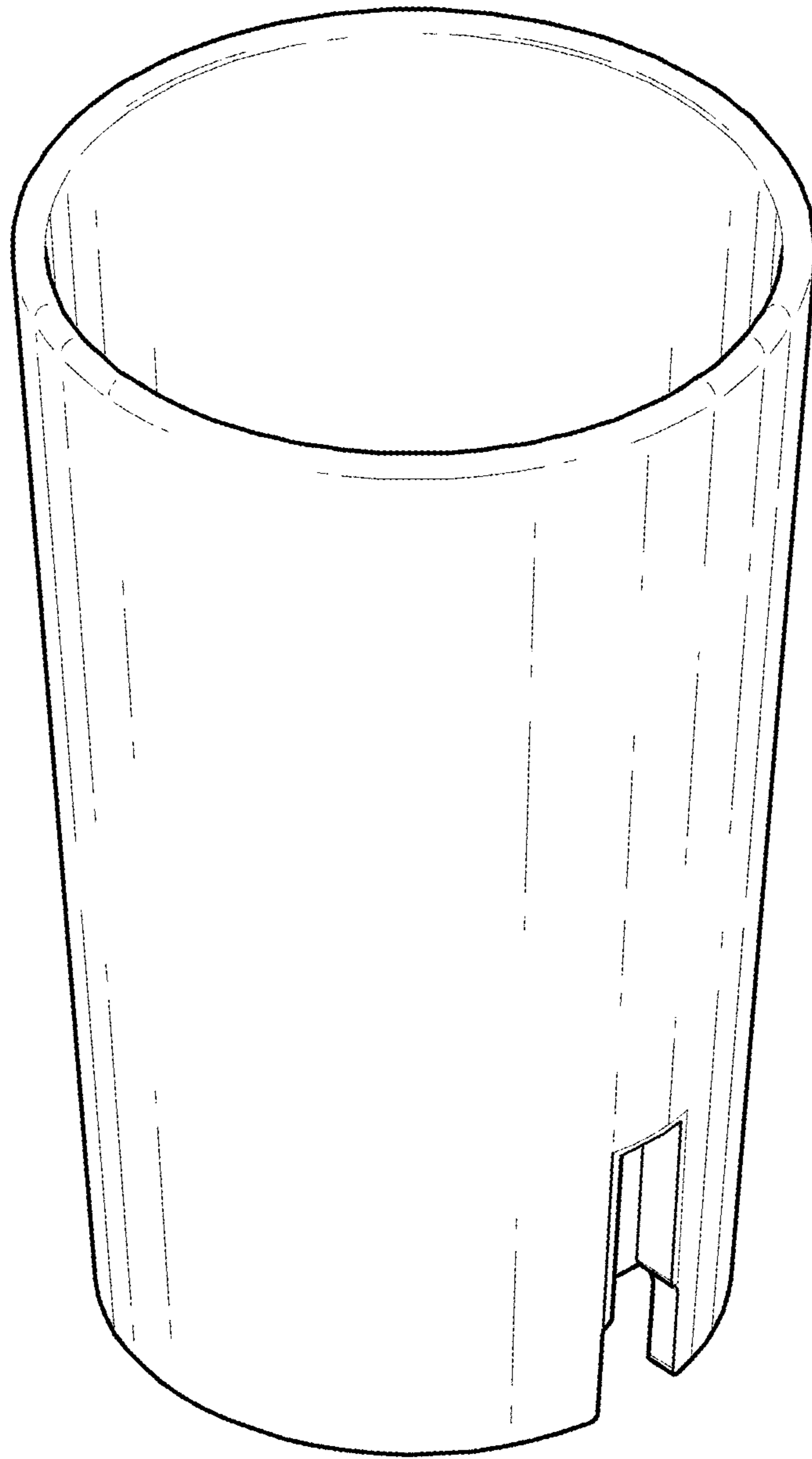

FIG. 1

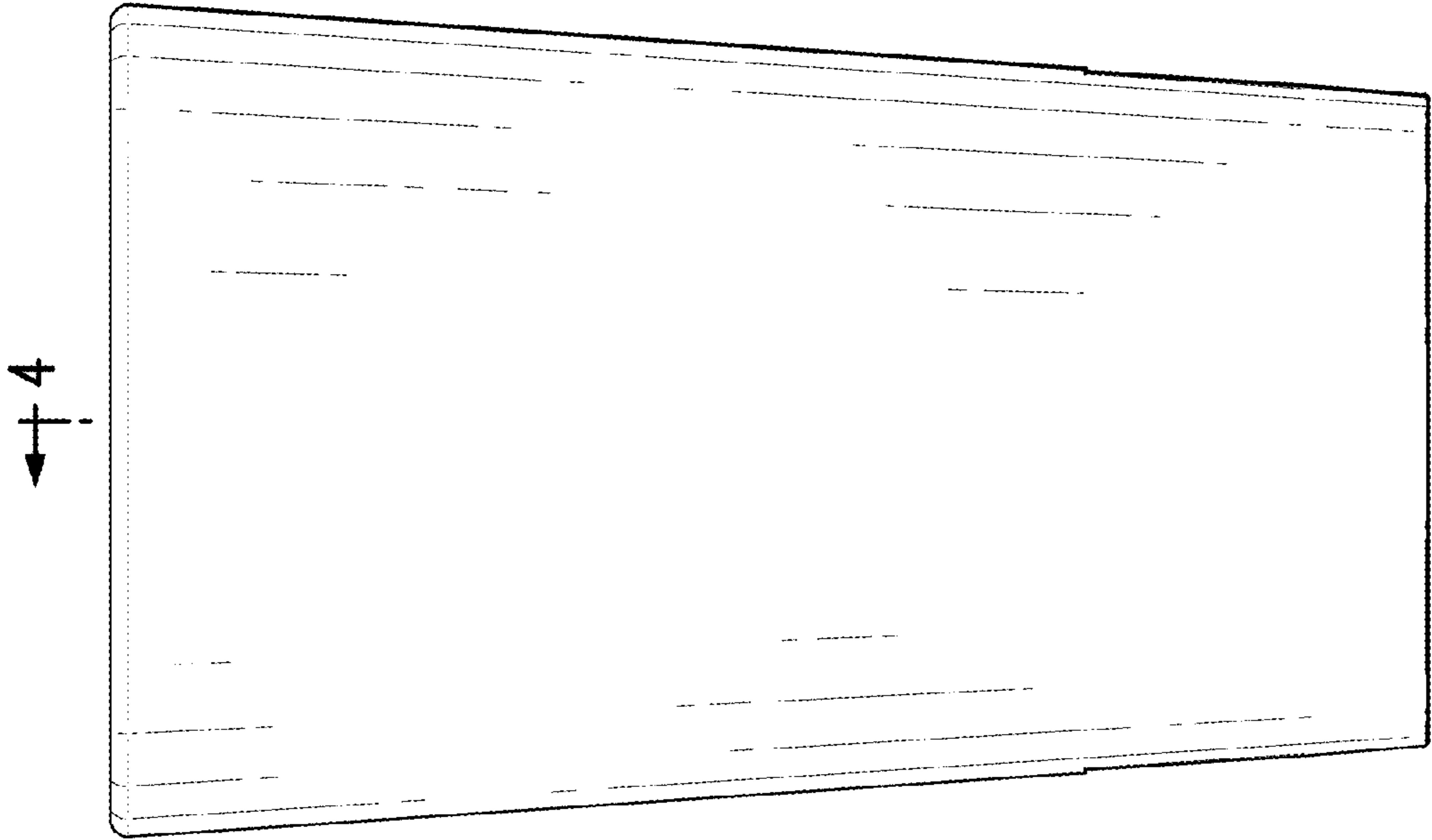

FIG. 3

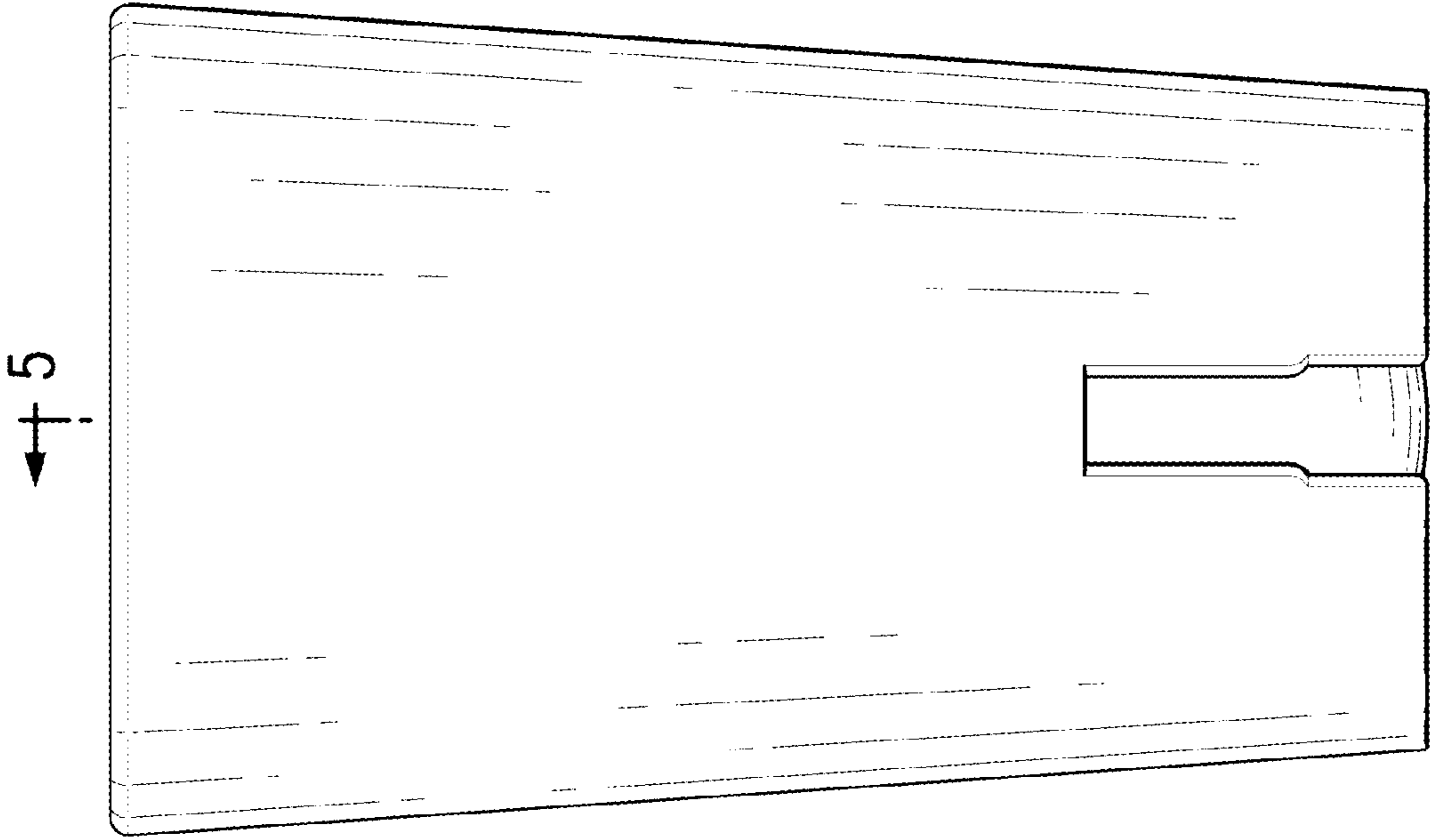

FIG. 2

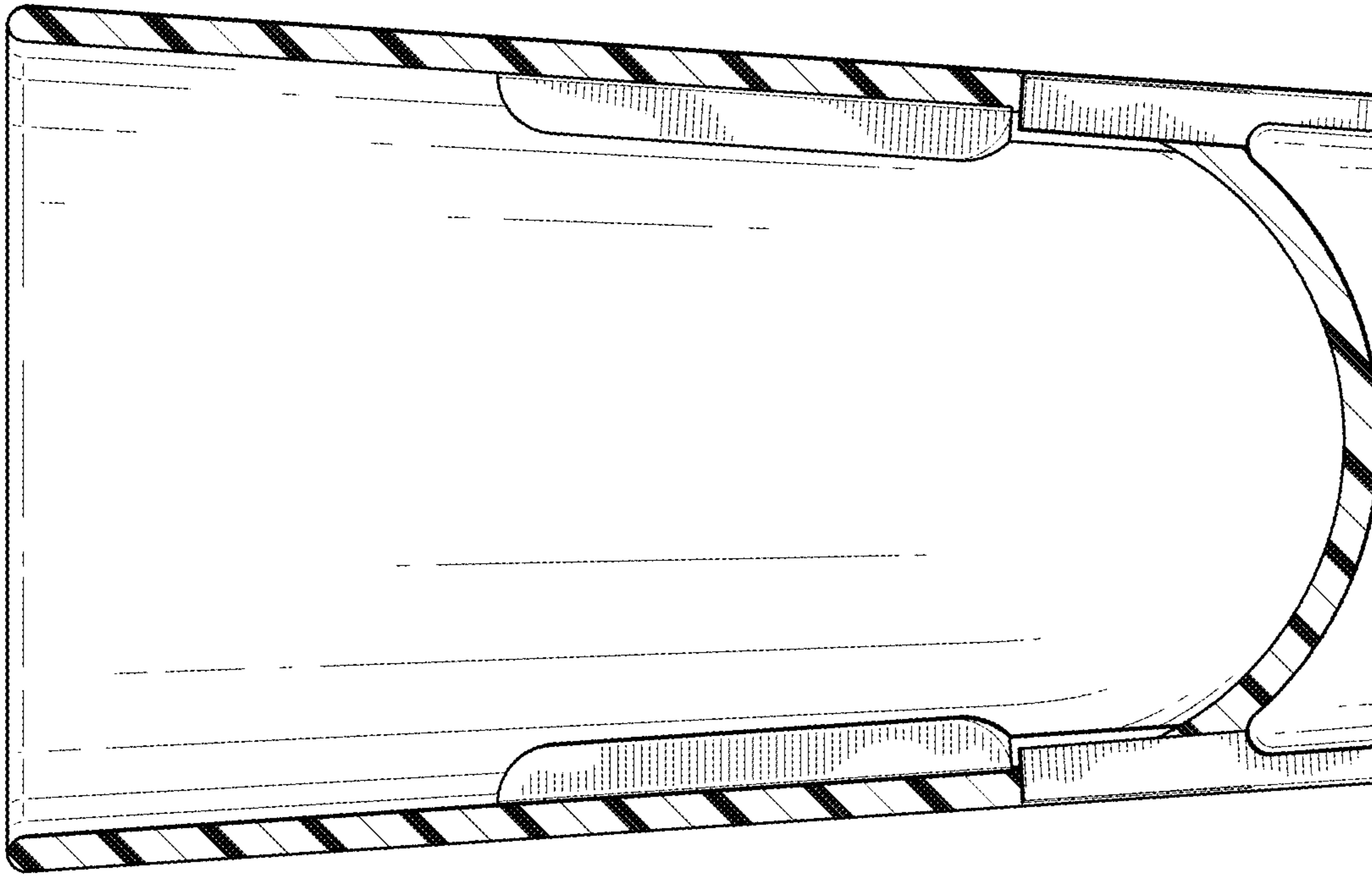

FIG. 5

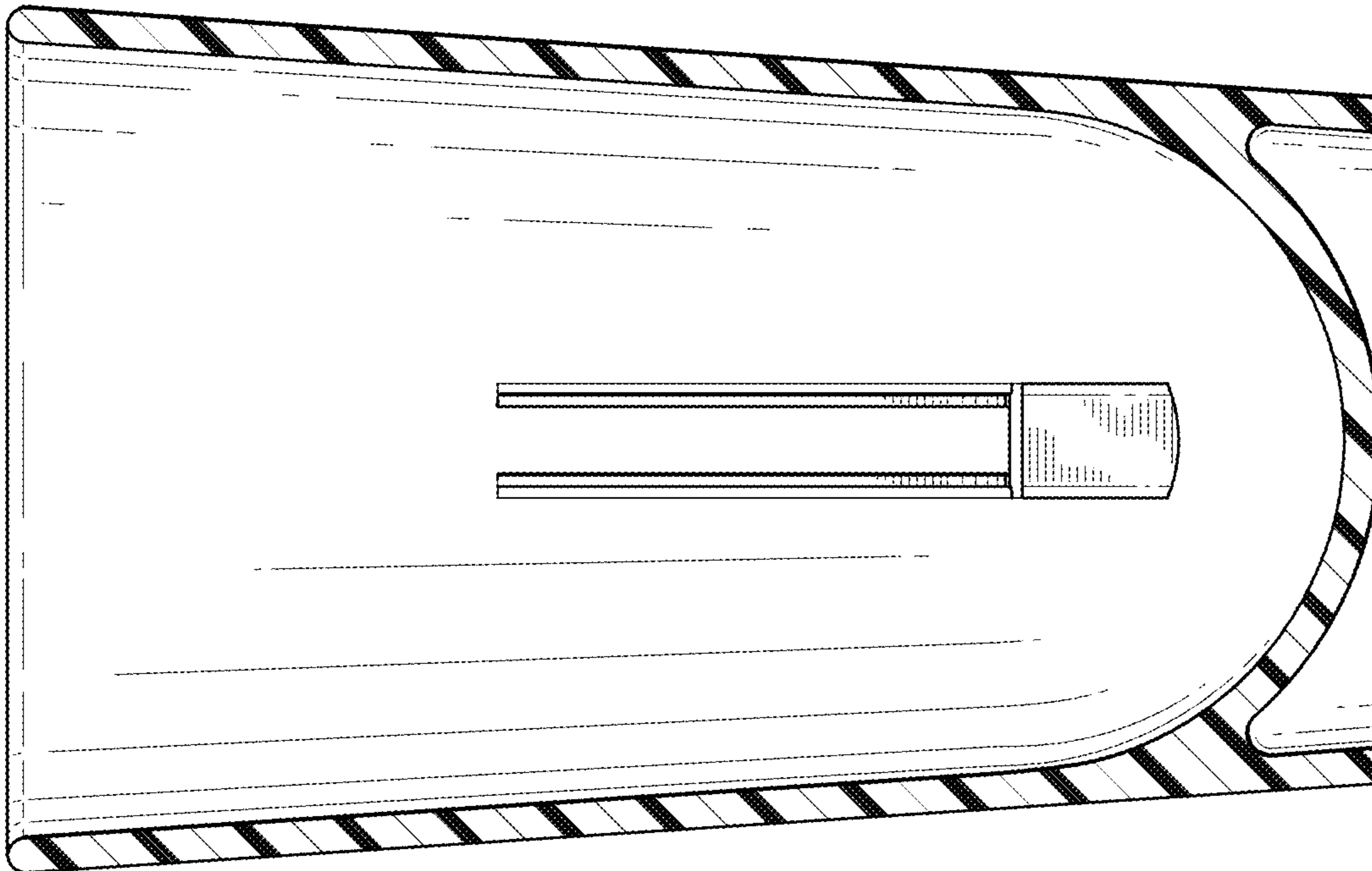

FIG. 4

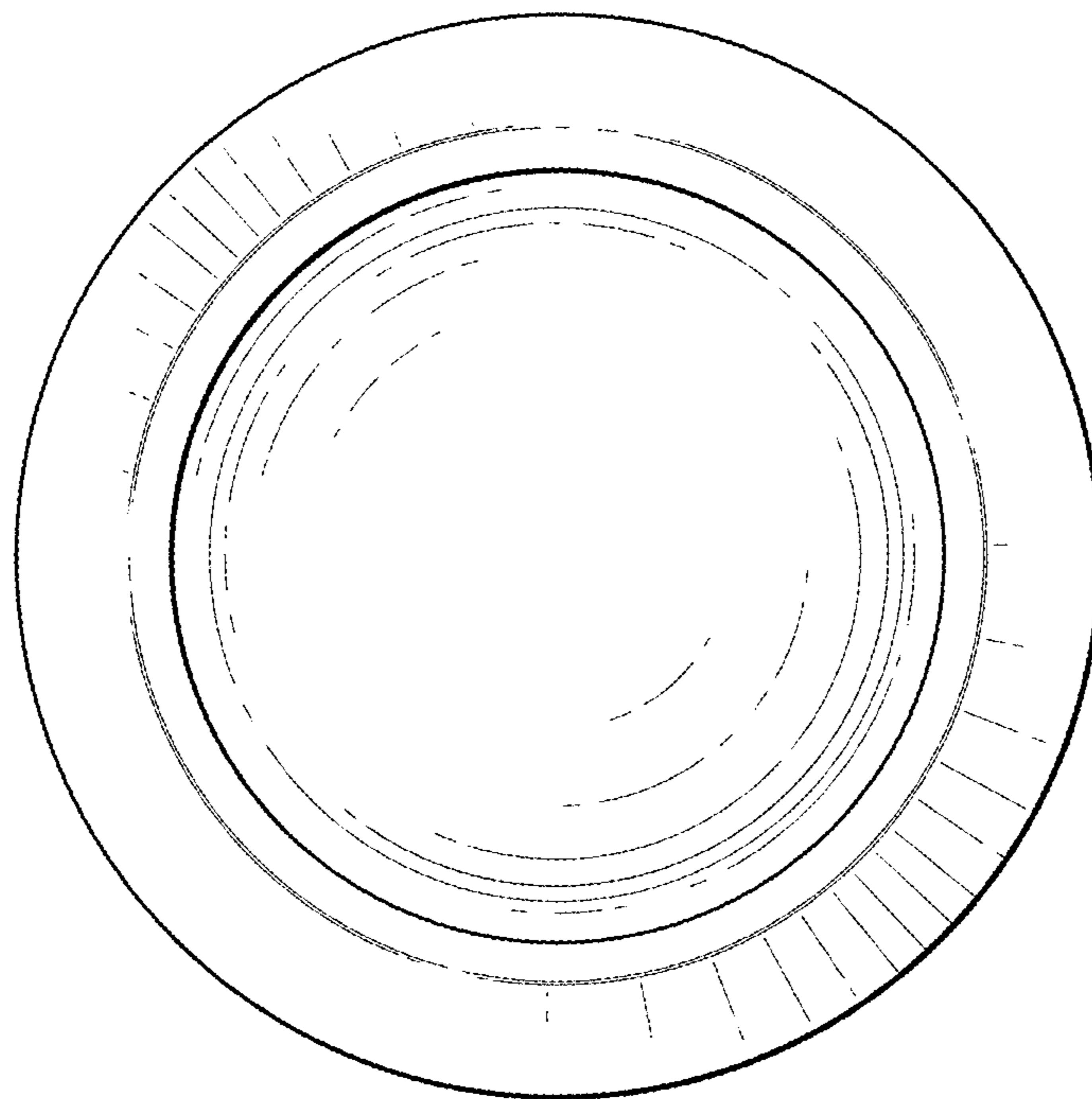

FIG. 6

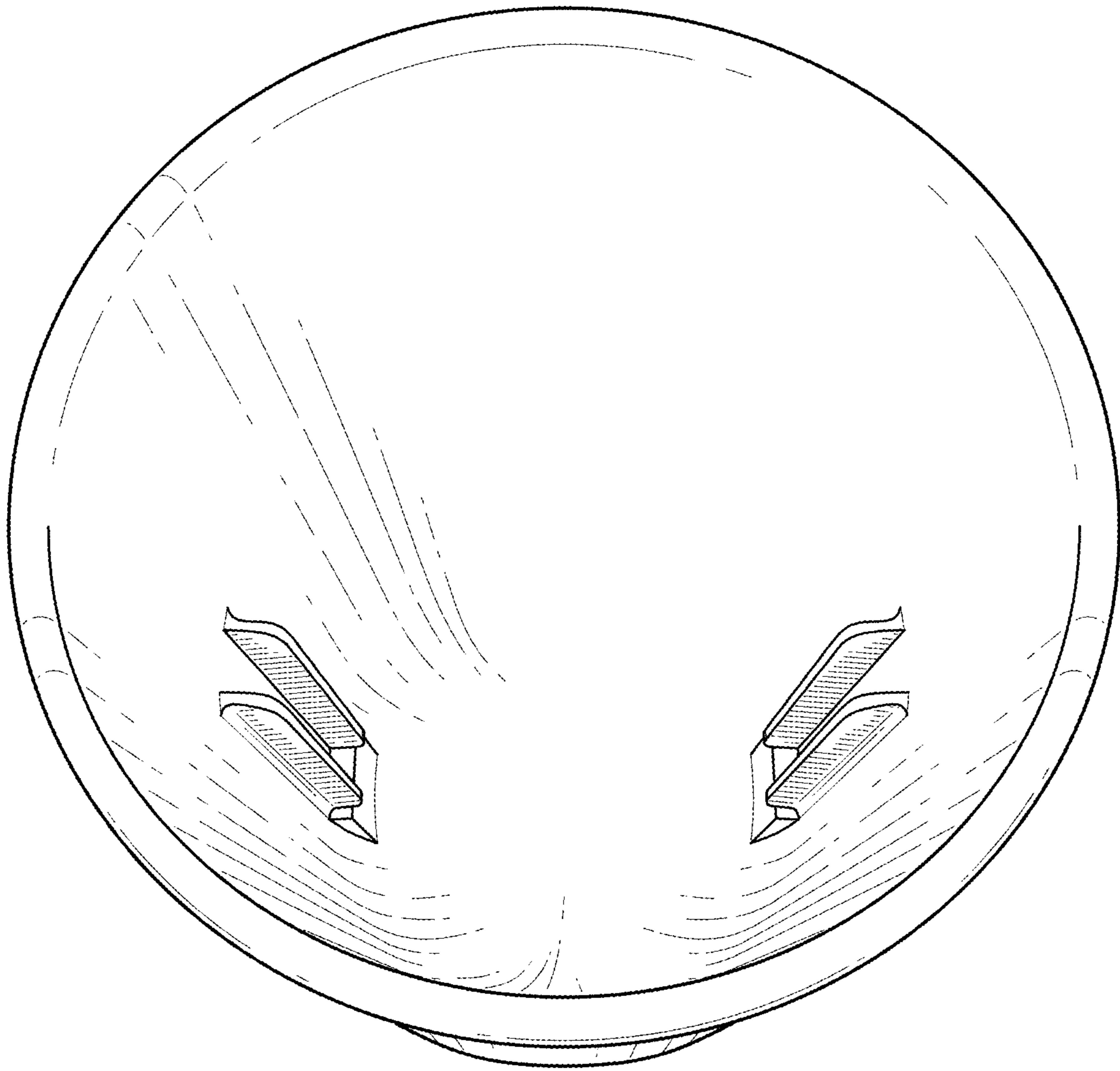

FIG. 7