



US00D943559S

(12) **United States Design Patent** (10) **Patent No.:** **US D943,559 S**
Lantz et al. (45) **Date of Patent:** **** *Feb. 15, 2022**

(54) **HOUSING FOR CEILING ARRAY MICROPHONE**

(71) Applicant: **Shure Acquisition Holdings, Inc.**, Niles, IL (US)

(72) Inventors: **Gregory William Lantz**, Aurora, IL (US); **John Matthew Miller**, Grayslake, IL (US); **Benjamin Neal Huyck**, Chicago, IL (US)

(73) Assignee: **Shure Acquisition Holdings, Inc.**, Niles, IL (US)

(*) Notice: This patent is subject to a terminal disclaimer.

(**) Term: **15 Years**

(21) Appl. No.: **29/711,744**

(22) Filed: **Nov. 1, 2019**

(51) **LOC (13) Cl.** **14-01**

(52) **U.S. Cl.**
USPC **D14/225; D14/229; D14/209**

(58) **Field of Classification Search**
USPC ... **D14/229, 225, 209, 209.1, 126, 204, 214, D14/210, 211, 219, 221, 250, 224, 224.1; D23/388; D6/300, 308; D20/43; 181/150; 381/391, 189, 345, 347; 248/250; 40/790, 793, 647; 52/764, 52/506.09**
CPC . **H04R 1/02; H04R 25/00; H04R 5/02; H04R 1/20; H04R 9/06; H04R 1/24; H04R 7/18; H05K 5/00; G10K 11/00; G09F 13/00**
See application file for complete search history.

(56) **References Cited**

U.S. PATENT DOCUMENTS

1,535,408 A * 4/1925 Fricke G09F 27/00 40/716

1,540,788 A * 6/1925 McClure E04C 2/422 52/799.12

1,965,830 A 7/1934 Hammer

2,075,588 A * 3/1937 Meyers A47G 1/0605 40/790

2,164,655 A * 7/1939 Kleerup G03D 15/10 156/492

D122,771 S * 10/1940 Doner D6/300

2,233,412 A * 3/1941 Hill E06B 9/52 160/378

2,343,037 A * 2/1944 Adelman E06B 9/52 160/381

2,377,449 A * 6/1945 Prevette E06B 9/52 160/106

2,481,250 A * 9/1949 Schneider F02N 15/063 74/7 R

2,521,603 A 9/1950 Prew

2,533,565 A * 12/1950 Eichelman G09F 15/0025 40/603

2,828,508 A * 4/1958 Labarre B29C 45/06 425/146

2,840,181 A * 6/1958 Wildman H04R 1/288 181/199

2,882,633 A * 4/1959 Howell G09F 15/0018 40/793

2,912,605 A 11/1959 Tibbetts

2,938,113 A 5/1960 Schnell

3,019,854 A 2/1962 OBryant

3,143,182 A 8/1964 Sears

3,160,225 A * 12/1964 Sechrist H04R 1/2857 181/151

3,161,975 A 12/1964 McMillan

3,205,601 A 9/1965 Gawne

3,310,901 A * 3/1967 Sarkisian A47G 1/0611 40/793

3,509,290 A 4/1970 Mochida

3,696,885 A * 10/1972 Grieg H04R 1/42 181/141

3,857,191 A 12/1974 Sadorus

D237,103 S * 10/1975 Fisher D25/119

3,938,617 A 2/1976 Forbes

3,941,638 A * 3/1976 Horkey H04R 1/02 156/196

4,008,408 A 2/1977 Kodama

4,029,170 A 6/1977 Phillips

4,032,725 A 6/1977 McGee

4,127,156 A * 11/1978 Brandt E06B 9/01 160/179

D255,234 S 6/1980 Wellward

D256,015 S 7/1980 Doherty

4,212,133 A 7/1980 Lufkin

4,244,096 A 1/1981 Kashichi

4,429,850 A * 2/1984 Weber A47F 5/0846 108/108

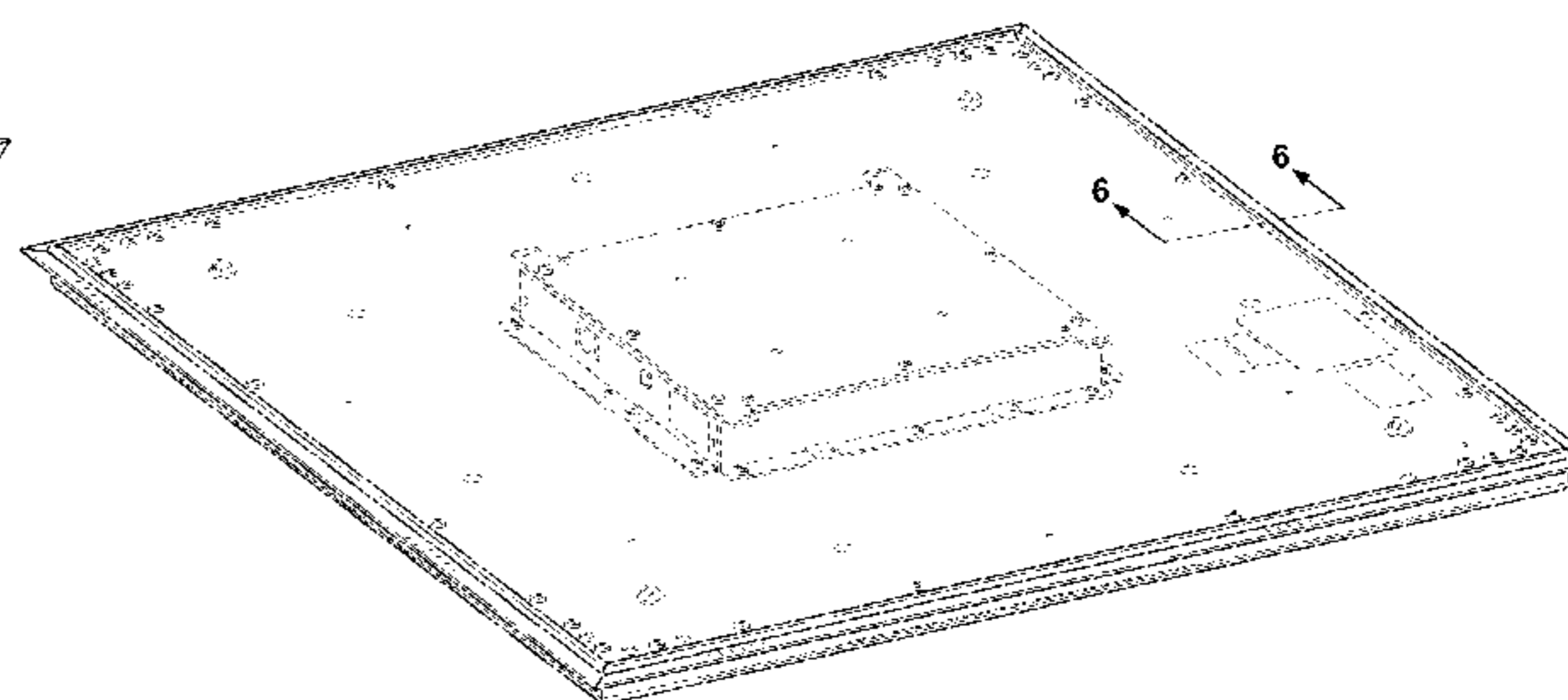
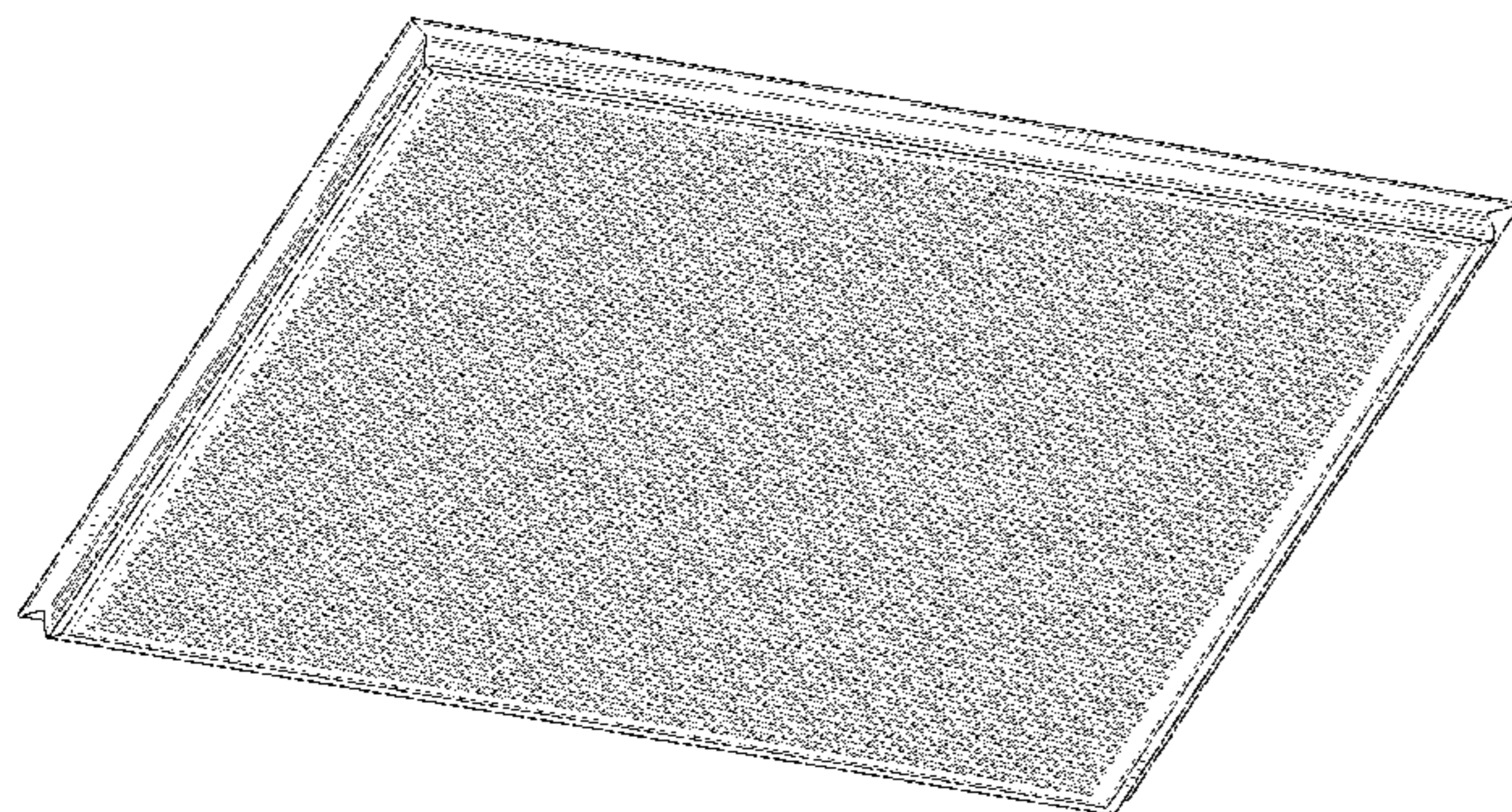

US D943,559 S

4,518,826 A	5/1985	Caudill		8,670,581 B2	3/2014	Harman
4,566,557 A	1/1986	Lemaitre		8,672,087 B2	3/2014	Stewart
4,866,868 A *	9/1989	Kass	G09F 3/201 40/661	D717,272 S	11/2014	Kim
4,969,197 A	11/1990	Takaya		D718,731 S *	12/2014	Lee D14/126
5,038,935 A	8/1991	Wenkman		D725,059 S *	3/2015	Kim D14/126
D329,239 S	9/1992	Hahn		D725,631 S	3/2015	McNamara
D340,718 S	10/1993	Leger		D726,144 S	4/2015	Kang
D345,346 S	3/1994	Alfonso		D729,767 S	5/2015	Lee
D345,379 S	3/1994	Chan		D737,245 S *	8/2015	Fan D14/214
5,322,979 A	6/1994	Cassity		9,126,827 B2	9/2015	Hsieh
5,359,374 A	10/1994	Schwartz		D743,376 S	11/2015	Kim
5,383,293 A	1/1995	Royal		D743,939 S	11/2015	Seong
5,400,413 A	3/1995	Kindel		9,226,088 B2	12/2015	Pandey
D363,045 S	10/1995	Phillips		D754,103 S	4/2016	Fischer
5,509,634 A *	4/1996	Gebka	G09F 3/204 24/336	9,319,799 B2	4/2016	Salmon
5,645,257 A *	7/1997	Ward	A47B 57/565 108/108	9,403,670 B2	8/2016	Schelling
5,717,171 A *	2/1998	Miller	H04R 1/023 181/150	9,565,493 B2	2/2017	Abraham
D392,977 S	3/1998	Kim		D784,299 S *	4/2017	Cho D14/225
D394,061 S	5/1998	Fink		D864,136 S *	10/2019	Kim D14/126
5,870,482 A	2/1999	Loeppert		D865,723 S *	11/2019	Cho H04R 31/00 D14/225
5,888,412 A	3/1999	Sooriakumar		D900,070 S *	10/2020	Lantz D14/229
5,888,439 A *	3/1999	Miller	H04R 1/023 264/248	D900,071 S *	10/2020	Lantz D14/229
6,035,962 A	3/2000	Lin		D900,072 S *	10/2020	Lantz D14/229
6,039,457 A *	3/2000	O'Neal	F21S 8/00 362/217.16	D900,073 S *	10/2020	Lantz D14/229
D424,538 S	5/2000	Hayashi		D900,074 S *	10/2020	Lantz D14/229
D432,518 S	10/2000	Muto		D924,189 S *	7/2021	Park D14/126
6,144,746 A	11/2000	Azima		11,109,133 B2 *	8/2021	Lantz H04R 1/406
6,198,831 B1	3/2001	Azima		2002/0146282 A1 *	10/2002	Wilkes A47F 5/0068 403/331
6,205,224 B1	3/2001	Underbrink		2002/0149070 A1	10/2002	Sheplak
6,266,427 B1	7/2001	Mathur		2003/0063762 A1	4/2003	Tajima
6,285,770 B1	9/2001	Azima		2005/0286729 A1 *	12/2005	Harwood H04R 7/04 381/152
D453,016 S	1/2002	Nevill		2006/0159293 A1	7/2006	Azima
6,393,129 B1	5/2002	Conrad		2006/0192976 A1	8/2006	Hall
6,488,367 B1	12/2002	Debasis		2006/0198541 A1	9/2006	Henry
D480,923 S *	10/2003	Neubourg	D7/554.3	2006/0215866 A1 *	9/2006	Francisco H04R 1/025 381/345
6,665,971 B2 *	12/2003	Lowry	G09F 3/20 40/642.02	2007/0120029 A1	5/2007	Keung
D489,707 S	5/2004	Kobayashi		2009/0087001 A1	4/2009	Jiang
D504,889 S	5/2005	Andre		2009/0173030 A1	7/2009	Gulbrandsen
6,944,312 B2 *	9/2005	Mason	H04R 1/025 381/189	2009/0173570 A1	7/2009	Levit
6,993,145 B2	1/2006	Combest		2010/0011644 A1	1/2010	Kramer
D526,643 S	8/2006	Ishizaki		2010/0314513 A1	12/2010	Evans
D527,372 S	8/2006	Allen		2011/0007921 A1	1/2011	Stewart
D542,543 S	5/2007	Bruce		2011/0311085 A1	12/2011	Stewart
D546,318 S	7/2007	Yoon		2012/0002835 A1	1/2012	Stewart
D547,748 S	7/2007	Tsuge		2012/0080260 A1	4/2012	Stewart
D549,673 S	8/2007	Niitsu		2012/0177219 A1	7/2012	Mullen
D552,570 S	10/2007	Niitsu		2012/0294472 A1	11/2012	Hudson
D559,553 S	1/2008	Mischel		2013/0004013 A1	1/2013	Stewart
D566,685 S	4/2008	Koller		2013/0015014 A1	1/2013	Stewart
7,387,151 B1 *	6/2008	Payne	E06B 5/006 160/371	2013/0039504 A1	2/2013	Pandey
D587,709 S	3/2009	Niitsu		2013/0094689 A1	4/2013	Tanaka
D589,605 S	3/2009	Reedy		2013/0101141 A1	4/2013	McElveen
7,536,769 B2	5/2009	Pedersen		2013/0251181 A1	9/2013	Stewart
D595,736 S	7/2009	Son		2013/0264144 A1	10/2013	Hudson
7,565,949 B2	7/2009	Tojo		2013/0336516 A1	12/2013	Stewart
D613,338 S	4/2010	Marukos		2014/0072151 A1	3/2014	Ochs
7,701,110 B2	4/2010	Fukuda		2014/0233777 A1	8/2014	Tseng
D614,871 S	5/2010	Tang		2014/0264654 A1	9/2014	Salmon
D636,188 S	4/2011	Kim		2014/0265774 A1	9/2014	Stewart
D642,385 S	8/2011	Lee		2014/0270271 A1	9/2014	Dehe
8,064,629 B2	11/2011	Jiang		2014/0286518 A1	9/2014	Stewart
D656,473 S *	3/2012	Laube	D14/126	2014/0301586 A1	10/2014	Stewart
8,213,634 B1	7/2012	Daniel		2014/0357177 A1	12/2014	Stewart
8,286,749 B2	10/2012	Stewart		2015/0070188 A1	3/2015	Aramburu
8,297,402 B2	10/2012	Stewart		2015/0078582 A1	3/2015	Graham
8,403,107 B2	3/2013	Stewart		2015/0118960 A1	4/2015	Petit
D685,346 S	7/2013	Szymanski		2016/0031700 A1	2/2016	Sparks
8,479,871 B2	7/2013	Stewart		2018/0338205 A1	11/2018	Abraham
8,631,897 B2	1/2014	Stewart		2020/0288237 A1	9/2020	Abraham

FOREIGN PATENT DOCUMENTS

CA	2838856 A1	12/2012
CA	2846323 A1	9/2014

CN	102833664	A	12/2012
CN	104080289	A	10/2014
CN	306391029	*	3/2021
EM	007754643-0001	*	3/2020
EP	2721837	A1	4/2014
EP	2778310	A1	9/2014
WO	2010144148	A2	12/2010
WO	2012174159	A1	12/2012

DESCRIPTION

FIG. 1 is a front perspective view of a housing for a ceiling array microphone;
 FIG. 2 is a rear perspective view thereof;
 FIG. 3 is a side elevation view thereof, the other side elevation view and two end elevation views being identical thereto;
 FIG. 4 is a rear plan view thereof;
 FIG. 5 is a front plan view thereof;
 FIG. 6 is an enlarged cross-sectional view thereof taken in the direction of line 6-6 of FIG. 2, shown in an environment of use;
 FIG. 7 is a front perspective view thereof, shown in an environment of use;
 FIG. 8 is a rear perspective view thereof, shown in an environment of use;
 FIG. 9 is a side elevation view thereof, the other side elevation view and two end elevation views being identical thereto, shown in an environment of use;
 FIG. 10 is a rear plan view thereof, shown in an environment of use;
 FIG. 11 is a front plan view thereof, shown in an environment of use; and,
 FIG. 12 is an enlarged cross-sectional view thereof taken in the direction of line 12-12 of FIG. 8, shown in an environment of use.
 The broken lines in FIGS. 1 through 12 that show portions of the housing for ceiling array microphone form no part of the claimed design. The broken lines in FIGS. 6 through 12 that represent the ceiling form no part of the claimed design.

OTHER PUBLICATIONS

Arnold, et al., "A directional acoustic array using silicon micromachined piezoresistive microphones," *Journal of Acoustical Society of America*, 113 (1), pp. 289-298, Jan. 2003 (10 pp.).
 Chou, "Frequency-Independent Beamformer with Low Response Error," 1995 International Conference on Acoustics, Speech, and Signal Processing, pp. 2995-2998, May 9, 1995, 4 pp.
 International Search Report and Written Opinion for PCT/US2016/029751 dated Nov. 28, 2016, 21 pp.
 Office Action issued for Japanese Patent Application No. 2015-023781 dated Jun. 20, 2016.
 Order, Conduct of the Proceeding, *Clearone, Inc. v. Shure Acquisition Holdings, Inc.*, Nov. 2, 2020, 10 pp.
 Petitioner's Motion for Sanctions, *Clearone, Inc. v. Shure Acquisition Holdings, Inc.*, Aug. 24, 2020, 20 pp.

* cited by examiner

Primary Examiner — Paula Allen Greene
 (74) *Attorney, Agent, or Firm* — Neal, Gerber & Eisenberg LLP

(57) **CLAIM**

The ornamental design for a housing for a ceiling array microphone, as shown and described.

1 Claim, 12 Drawing Sheets

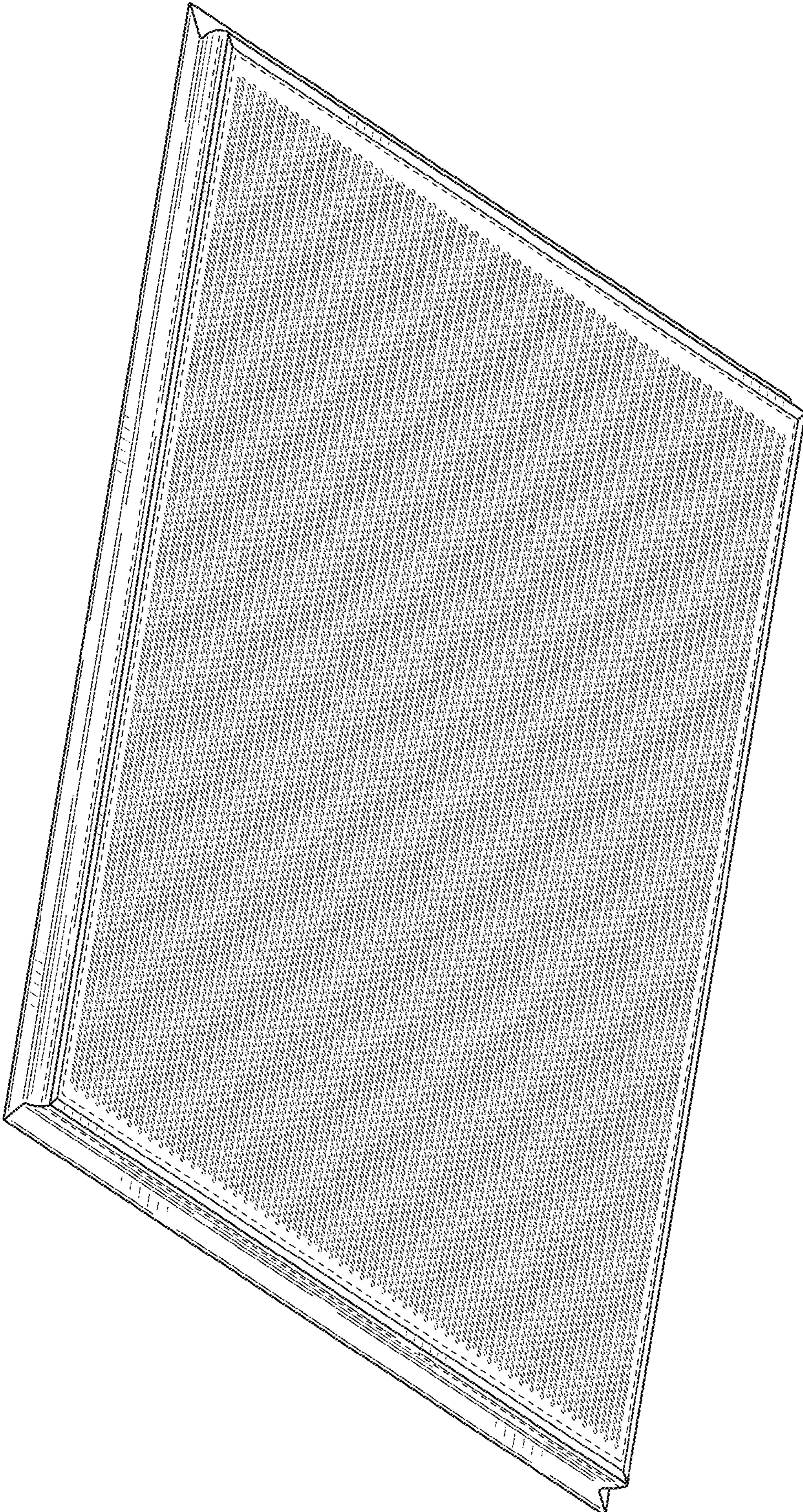

FIG. 1

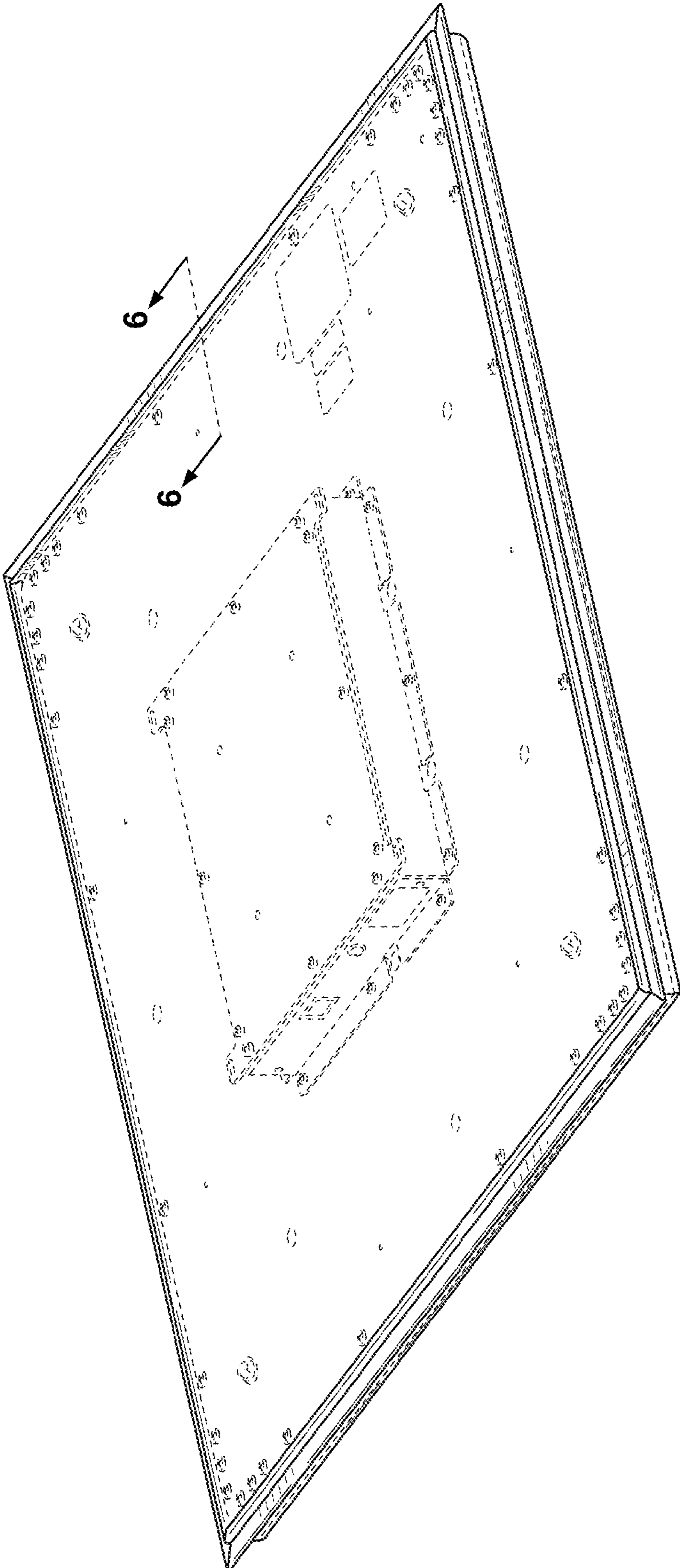

FIG. 2

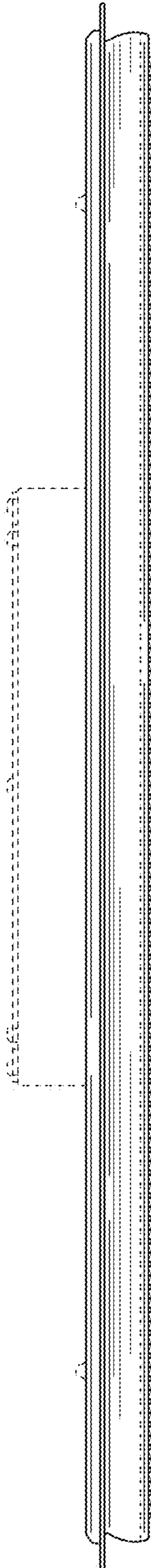

FIG. 3

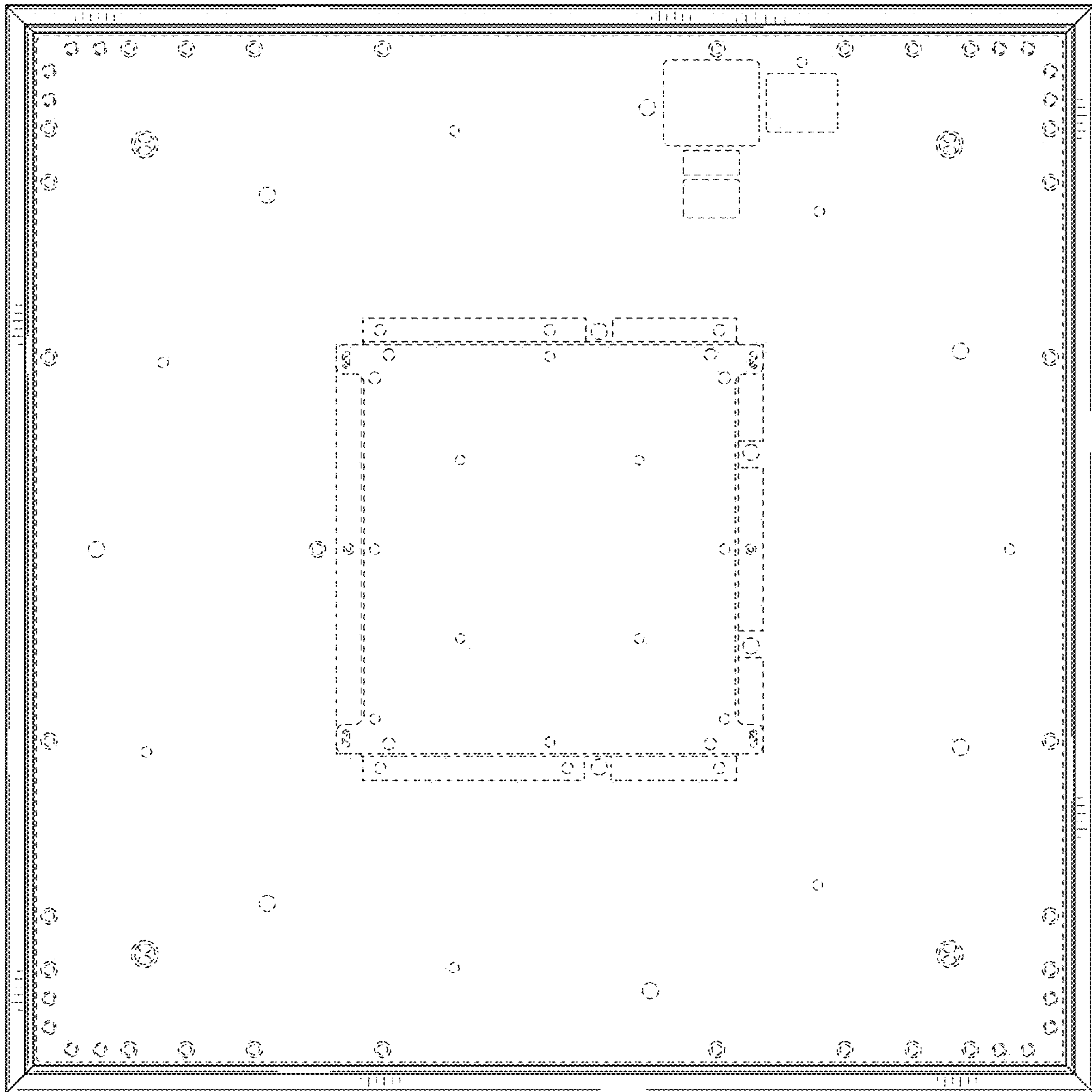
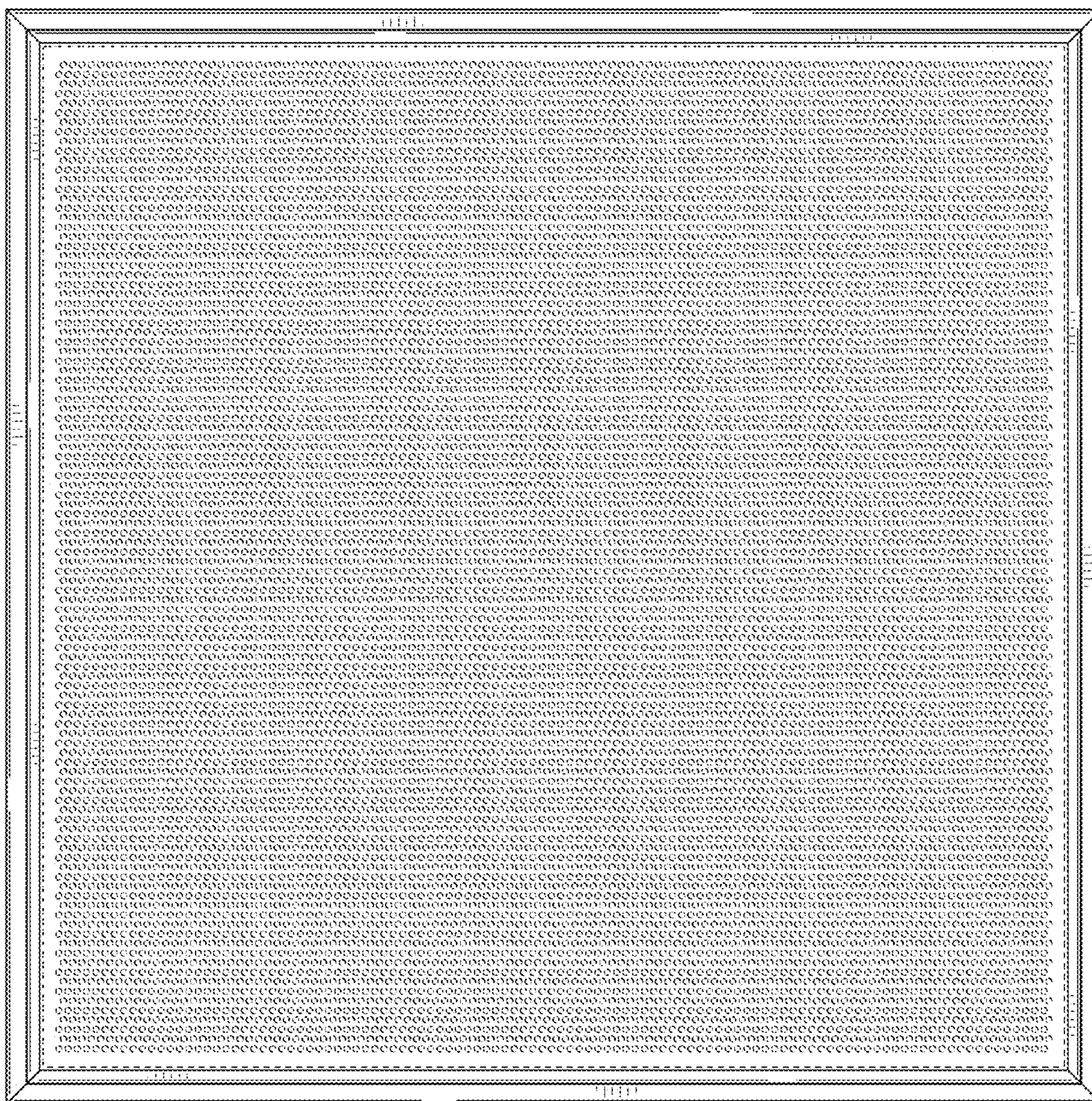

FIG. 4

FIG. 5



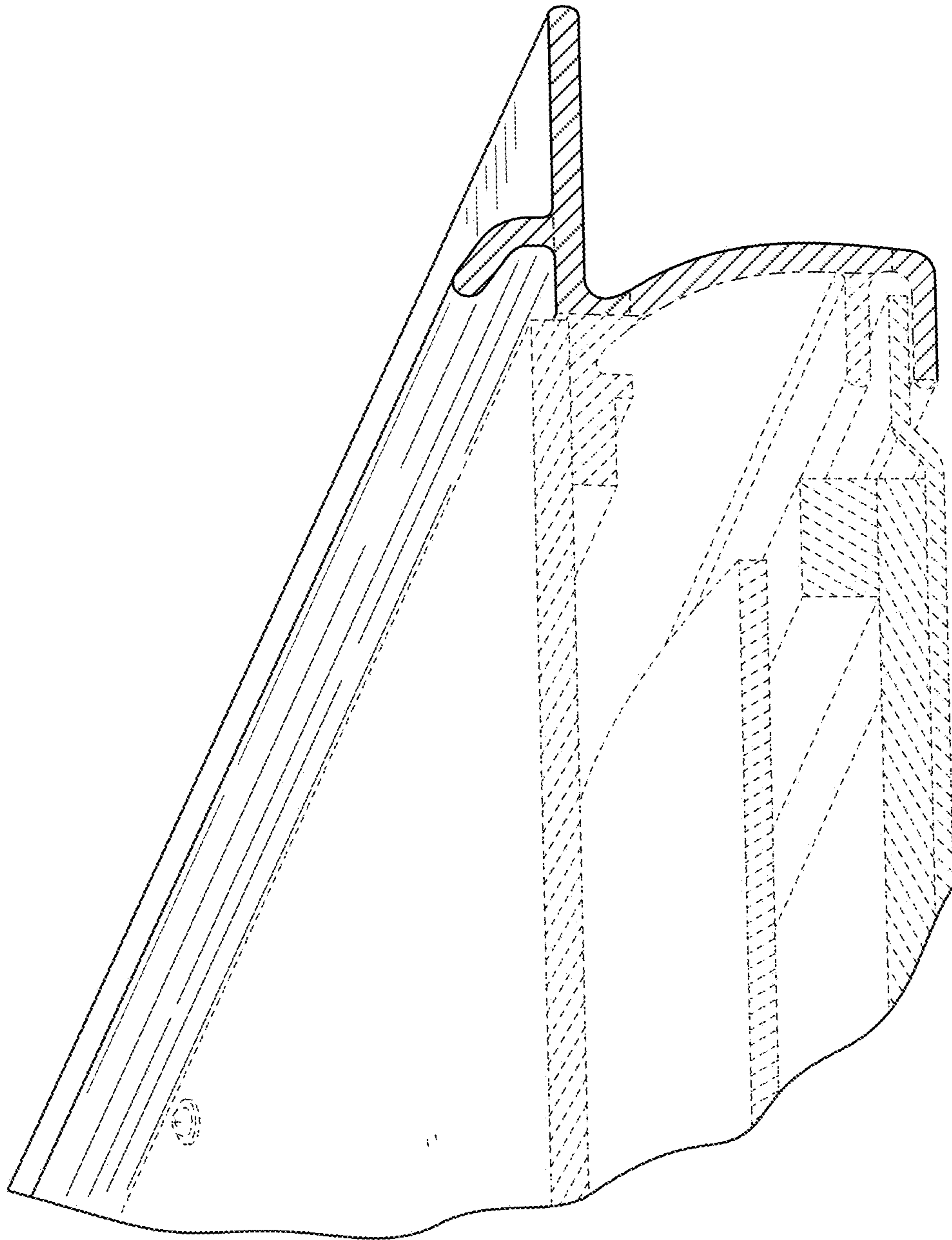

FIG. 6

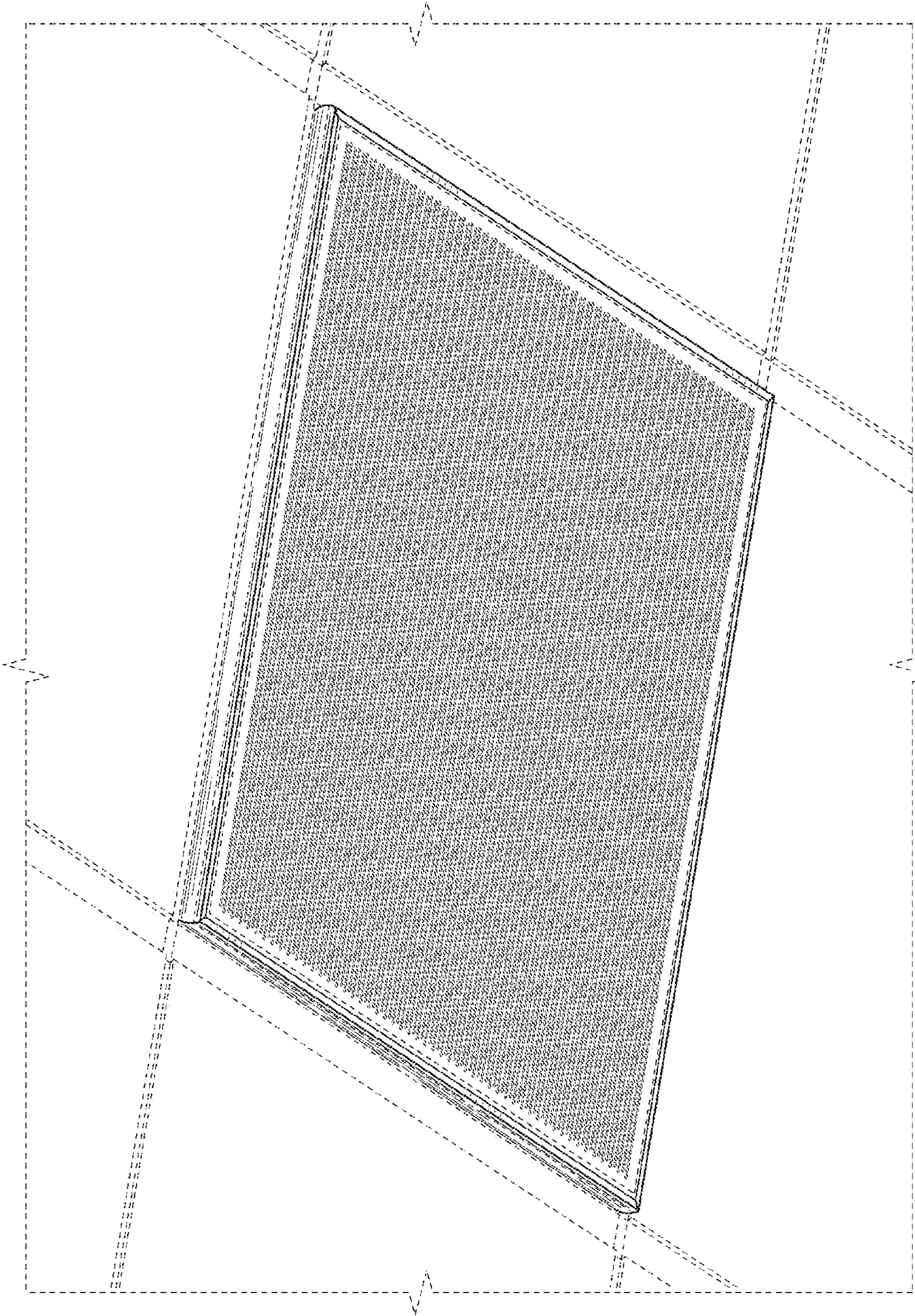

FIG. 7

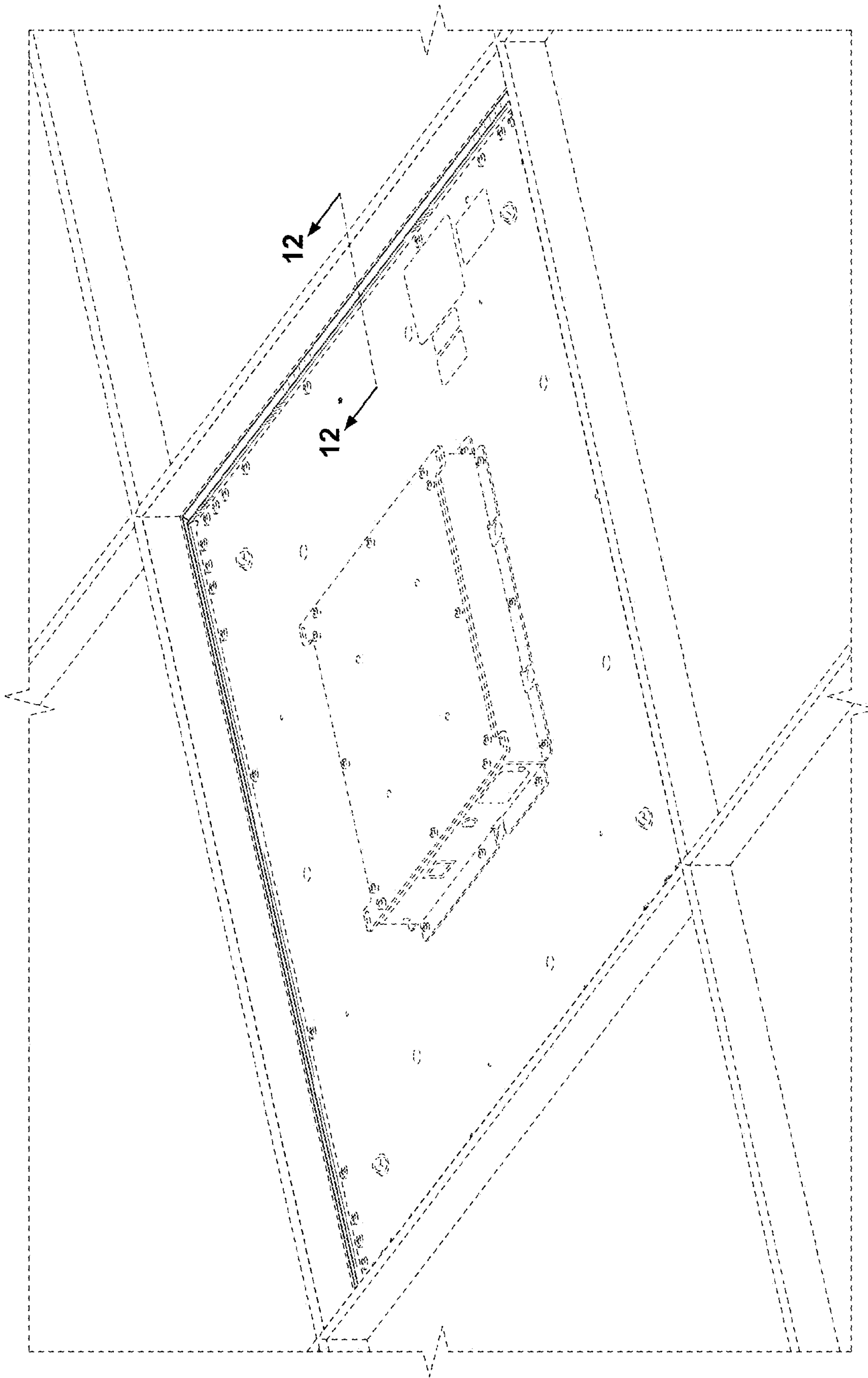

FIG. 8

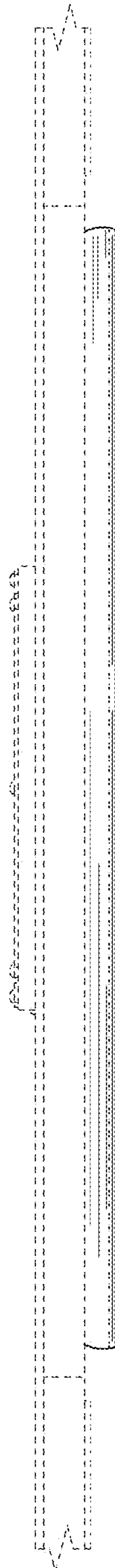

FIG. 9

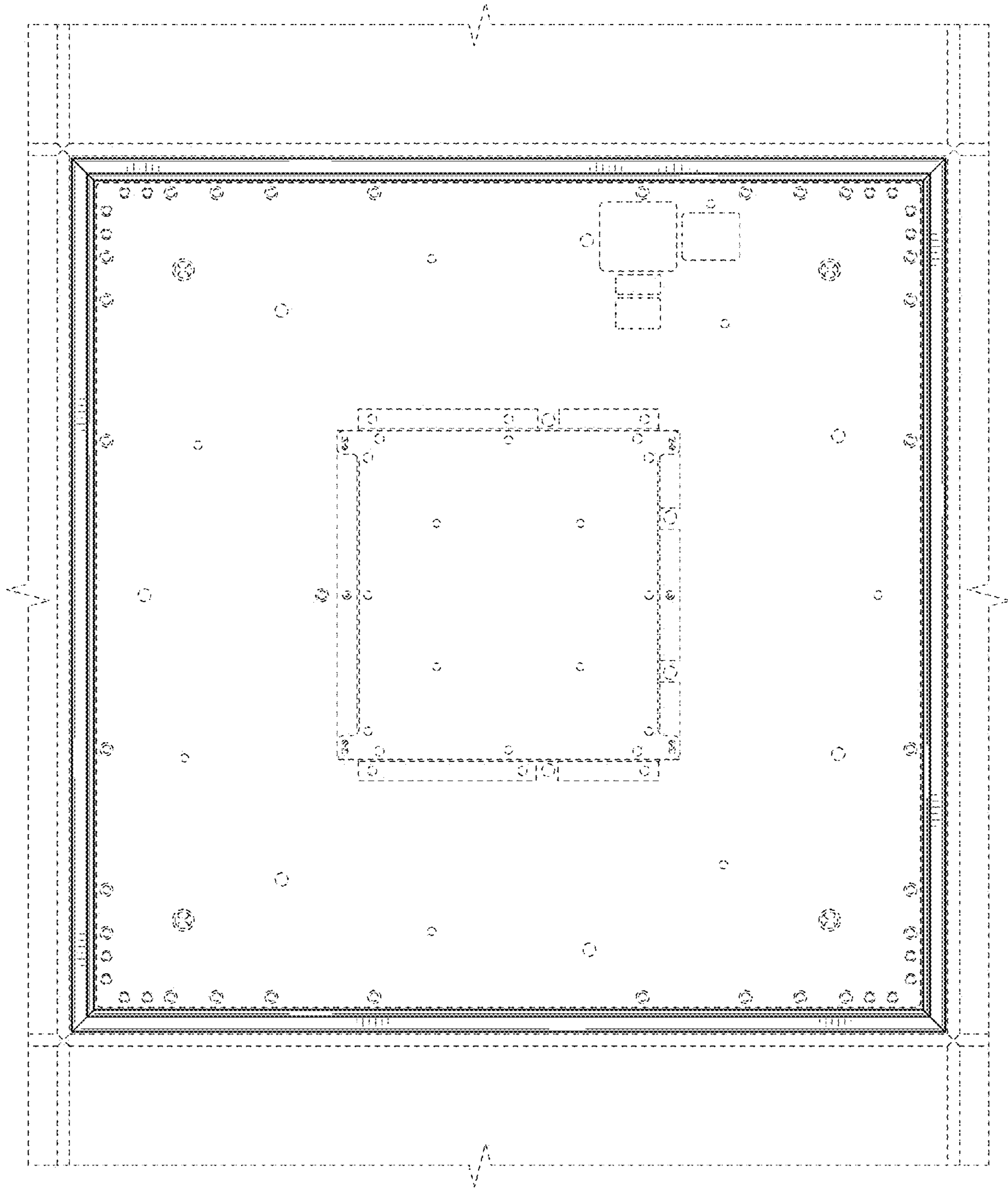
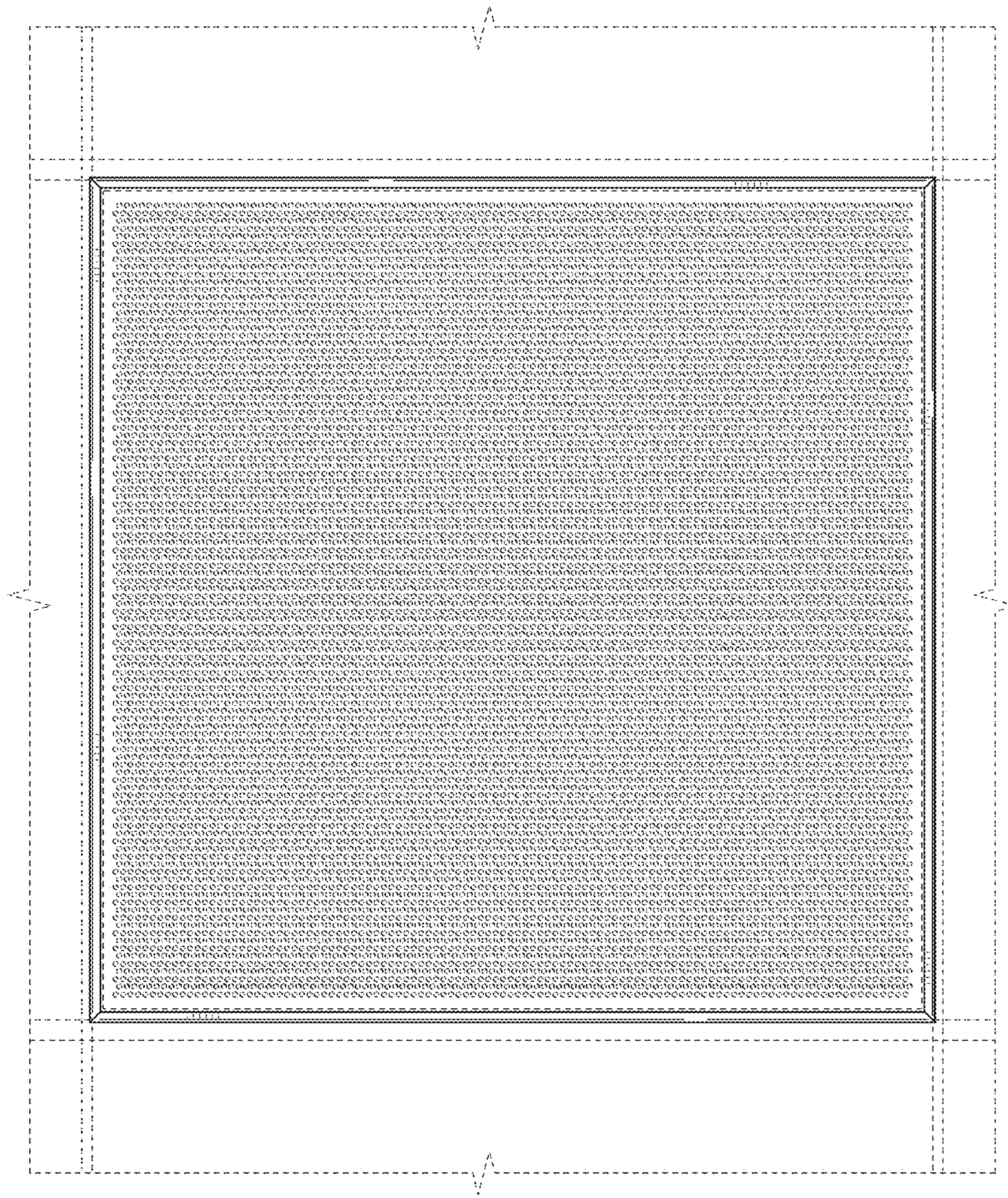

FIG. 10

FIG. 11



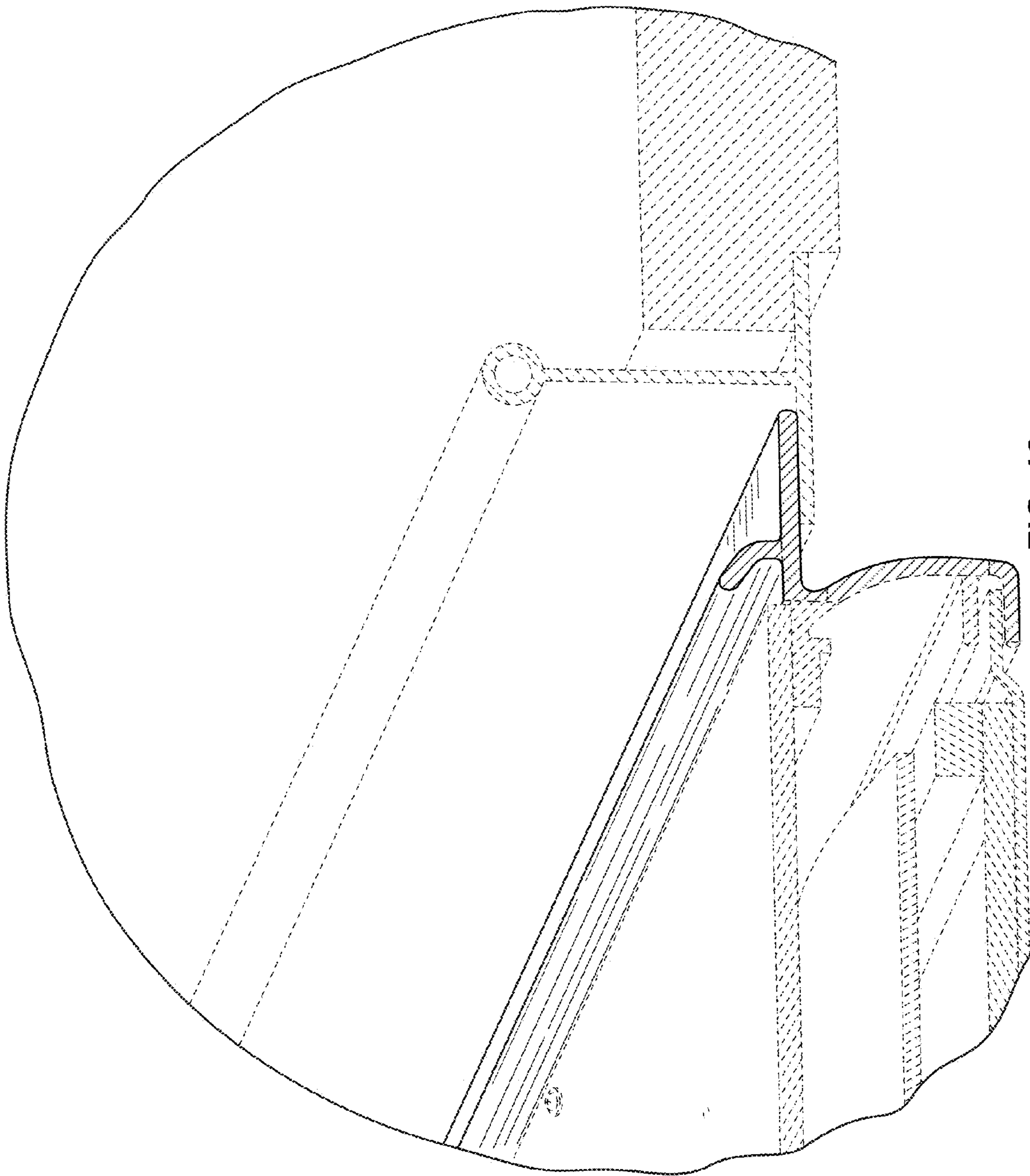

FIG. 12